

**PHILIPS**

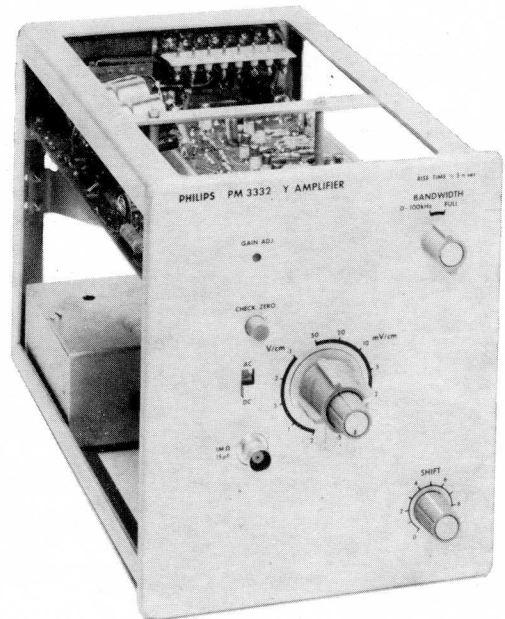

**PM 3332**  
**LOW DRIFT HIGH SENSITIVITY WIDE BAND AMPLIFIER**

**IMPORTANT**

*In correspondence concerning this apparatus, please quote the type number and the serial number as given on the type plate at the back of the apparatus.*

# Contents

<b>GENERAL INFORMATION</b>			
<b>I. Characteristics</b>	5		
<b>II. Description of the Block Diagram</b>	6		
<b>DIRECTIONS FOR USE</b>			
<b>III. Installation</b>	7		
<b>IV. Functions of the Controls</b>	7		
A. Input	7		
B. Deflection coefficient	8		
C. Bandwidth	8		
D. Shift	8		
E. Gain Adjustment	8		
<b>V. Applications</b>	9		
<b>SERVICE DATA</b>			
<b>VI. Introduction</b>	11		
<b>VII. Principles of the control loop</b>	12		
		<b>VIII. Circuit description</b>	13
		A. Input circuit	13
		B. HF amplifier	13
		C. DC amplifier	13
		D. Interstage network	13
		E. Chopper amplifier	15
		F. Final amplifier	16
		<b>IX. Checking and Adjusting</b>	17
		A. Check of the chopper amplifier	17
		B. Grid current compensation	18
		C. Balance adjustment	19
		D. Square-wave response	19
		E. Deflection coefficient	20
		F. Frequency response curve	20
		G. Deflection and Shift	20
		H. AC/DC switch; Check zero	20
		I. Input attenuator	20
		<b>X. List of service parts</b>	22
		A. Mechanical parts	22
		B. Electrical parts	23

## List of Figures

<b>1</b>	Schematic diagram of the controls	7	<b>14</b>	Left-hand view	18
<b>2</b>	Input terminal and controls	7	<b>15</b>	Pulser	19
<b>3</b>	Y-deflection coefficient switch	8	<b>16</b>	Input RC standardiser	21
<b>4</b>	Bandwidth selector	8	<b>17</b>	Printed circuit U 7 (Supply filter)	27
<b>5</b>	Shift control	8	<b>18</b>	Printed circuit U 8 (Final stage)	27
<b>6</b>	Gain adjustment control	8	<b>19</b>	Printed circuit U 9 (Grid circuit)	27
<b>7</b>	Voltage measurement	9	<b>20</b>	Printed circuit U 10 (H.F. amplifier)	27
<b>8</b>	Limits of the Y deflection	9	<b>21</b>	Printed circuit U 11 (Amplifier)	29
<b>9</b>	Controlloop	12	<b>22</b>	Printed circuit U 12 (Chopper Amp.)	27
<b>10</b>	Bandwidth characteristics	14	<b>23</b>	Attenuator circuit	30
<b>11</b>	Operation of the cross-over filter	14	<b>24</b>	Chopper amplifier circuit	35
<b>12</b>	Operation of the demodulator	15	<b>25</b>	Final amplifier circuit	41
<b>13</b>	Right-hand view	17	<b>26</b>	HF and LF amplifier circuit	47

## GENERAL INFORMATION

The PM 3332 is an H.F. amplifier, built into a plug-in unit for the vertical channel of basic oscilloscope PM 3330.

Owing to its high sensitivity and bandwidth, the unit covers a wide range of applications.

The amplifier is chopper-stabilised, with the result that d.c. drift is eliminated.

Properties, expressed in numerical values with statement of tolerances are guaranteed by the factory. Numerical values without tolerances are intended for information purposes only and indicate the properties of an average apparatus.

The numerical values hold good for nominal mains voltages unless otherwise stated.

### Characteristics



#### Input circuit

input	asymmetrical
coupling	a.c. or d.c.
input socket	B.N.C.
input impedance	1 M $\Omega$ // 15 pF
maximum permissible d.c. voltage in position "AC"	400 V

#### Amplifier

zero level	by means of a push-button "CHECK ZERO", the zero level can be checked
deflection coefficient	adjustable to 12 calibrated values, i.e.: 500 $\mu$ V - 1 mV - 2 mV/cm etc. to 2 V/cm, tolerance $\pm 3\%$ continuous attenuation 1 : 3 is possible (non-calibrated)

#### Bandwidth

d.c.:	0...50 Mc/s ("FULL") or 0...100 kc/s
a.c.:	1.6 c/s...50 Mc/s ("FULL") or 1.6 c/s...100 kc/s

#### Noise in most sensitive position

at bandwidth 0...50 Mc/s	open input	4 mm
	short-circuited input	3 mm
at bandwidth 0...100 kc/s	open input	1.5 mm
	short-circuited input	0.4 mm

#### Rise time: at maximum bandwidth

7 nsec.

#### Rise time of the unit itself

5 nsec.

#### Overshoot

< 2%

#### Pulse droop

< 3%

#### Magnification

Up to 10 $\times$  the useful screen height (symmetrically around the centre of the screen)  
Of a picture that has been magnified to 3 $\times$  the useful screen height (symmetrical around the centre of the screen), the peaks can be made visible by means of the shift control



Drift	500 $\mu$ V/week
Triggering of the time base required picture height:	3 mm for frequencies up to 10 Mc/s 10 mm for frequencies up to 30 Mc/s 1 cm in position "AUT." 1 cm video signal in positions "TV LINE" and "TV FRAME"
Mechanical data	width 15 cm depth 27.5 cm (including knobs and plug) height 17.5 cm weight 2 kg
Accessories	Manual
Optional accessories	measuring probe PM 9331 A/10 input impedance 10 M $\Omega$ // 8 pF attenuation 1 : 10, tolerance $\pm$ 3% maximum permissible voltage 1000 V peak

## Description of the block diagram



The input circuit includes an "AC-DC" switch, a step attenuator ("mV/cm - V/cm") and a push-button "CHECK ZERO".

The step attenuator is connected, via a cathode follower stage, to two parallel connected amplifiers, an a.c. coupled H.F. amplifier and a d.c. coupled L.F. amplifier. The output voltages are applied to an output amplifier via a cross over filter.

The input signal of the output amplifier is compared, via an attenuator, with the signal on the input of the cathode follower stage.

The difference voltage, due to drift in the d.c. coupled

L.F. amplifier, is converted into a square-wave voltage by a mechanical chopper.

This square-wave voltage is amplified in an a.c. coupled amplifier and after that detected. The output signal of the detector is applied to the d.c. coupled L.F. amplifier, with the result that drift in this amplifier is heavily fed back.

The output amplifier contains the continuous gain control, the "SHIFT" control and a screwdriver adjustment "GAIN ADJ.".

The output voltage of the output amplifier is applied to the vertical amplifier and the trigger preamplifier, via the Y-plug.

# DIRECTIONS FOR USE



## Installation

The PM 3332 should be slid into the left-hand compartment (Y-unit) of the basic oscilloscope PM 3330.

Switching on is effected via the mains switch of the basic oscilloscope.

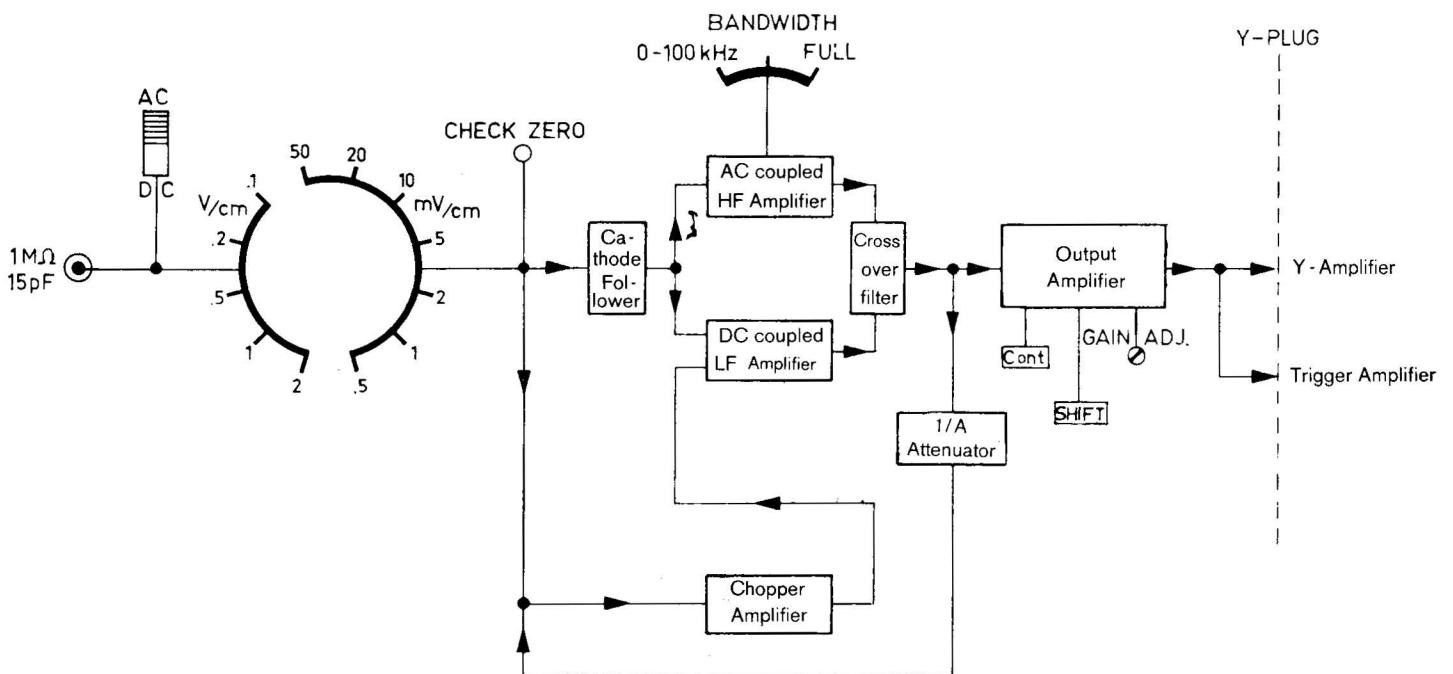

PEM 2891

Fig. 1. Schematic diagram of the controls

## Functions of the controls



Fig. 1

### A. INPUT

The input socket "1 MΩ// 15 pF" is connected to the step attenuator ("mV/cm" - "V/cm") via switch "AC-DC". In position "AC", the input is a.c. coupled to the attenuator; in position "DC" the coupling is direct. By depressing push-button "CHECK ZERO", the connection between the step attenuator and the amplifier is cut-off and the input of the amplifier is earthed. With this the zero level of the amplifier can be checked.

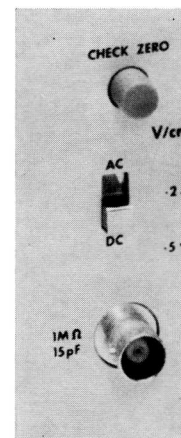

Fig. 2. Input terminal and controls

## B. DEFLECTION COEFFICIENT

The deflection coefficients are adjusted by means of the attenuator (“mV/cm” – “V/cm”). These deflection coefficients are calibrated if the continuous gain control is turned fully clockwise (indicated with “CAL.”).

## C. “BANDWIDTH”

The maximum bandwidth is obtained by setting switch “BANDWIDTH” to position “FULL”. In the most sensitive position of the attenuator, a noise band having a width of a few millimetres will appear on the screen.

In position “0...100 kc/s” of switch “BANDWIDTH”, the bandwidth of the amplifier is limited to the indicated value at which the noise can be neglected.

**Note:** The noise is also reduced while maintaining the maximum bandwidth, by reducing the sensitivity of the amplifier by means of the attenuator.

## D. “SHIFT”

The picture can be shifted in a vertical direction with the aid of knob “SHIFT”.

## E. “GAIN ADJ.”

The deflection coefficients of the unit can be checked by applying the calibration voltage of the basic oscilloscope to the input of the unit. If the deflection coefficients do not correspond to the values indicated on the text plate, the coefficients can be corrected by means of setting “GAIN”.

**Note:** With this adjustment, the continuous gain control should be turned fully clockwise, (“CAL”).

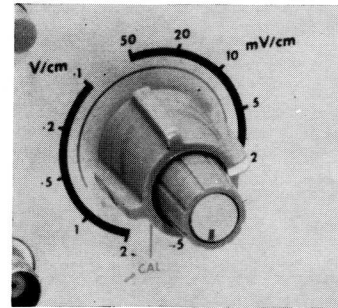

Fig. 3. Y-deflection coefficient switch

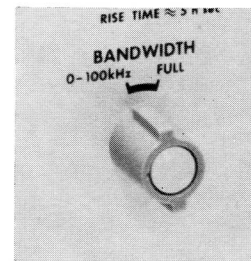

Fig. 4. Bandwidth selector

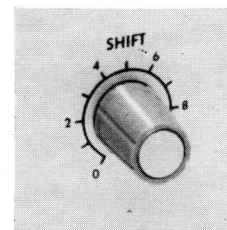

Fig. 5. Shift control

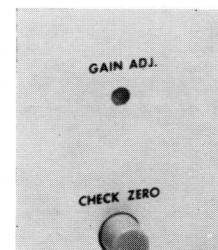

Fig. 6. Gain adjustment control

# Applications



## Voltage measurements

When measuring the voltage of a signal use is made of the calibrated deflection coefficients of the vertical deflection system. Using the control elements on the plug-in unit and the basic oscilloscope, adjust to a triggered trace.

In Fig. 7 the peak-to-peak value amounts to  $3 \times 20 \text{ mV} = 60 \text{ mV}$ .

**Note:** The tolerance of the deflection coefficient (3%) can be reduced by adjusting, in the position used, the deflection coefficient by means of setting "GAIN ADJ."

For this, the calibration voltage of the basic oscilloscope can be used.

Figure 8 indicates the maximum magnification (A) and the part of the magnified signal (B) that can be displayed on the screen (C) by means of the "SHIFT" control.

**Note:** When loading to more than  $10 \times$  the useful screen height, the amplifier will be overloaded. The picture then obtained is no longer proportional to the input voltage.

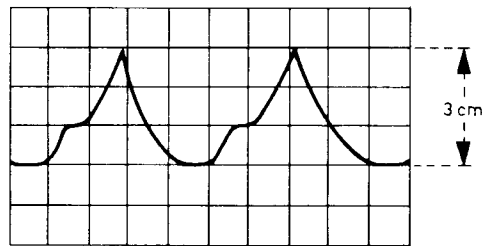

Fig. 7. Voltage measurement

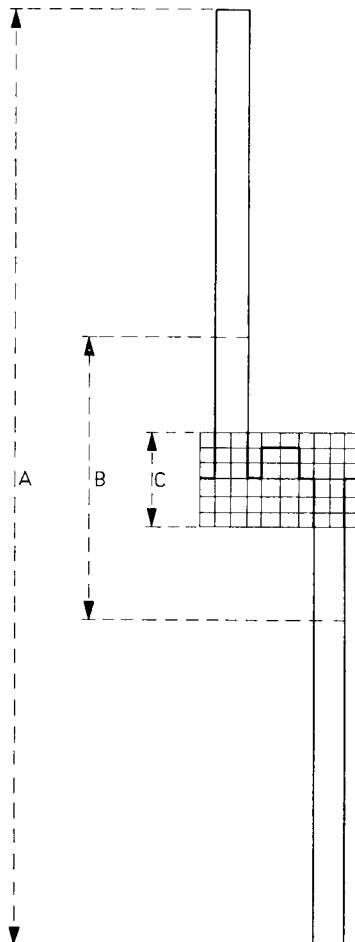
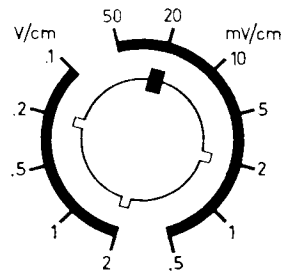

Fig. 8. Limits of the Y deflection

# SERVICE DATA

VI

## Introduction

The pre-amplifier consists of an AC coupled HF-amplifier and a DC coupled LF-amplifier the outputs of which are combined by a cross-over filter. The latter forms a high-pass filter for the HF-amplifier and a low-pass filter for the DC-amplifier. The HF-amplifier has a bandwidth from 300 Hz to 100 MHz; the DC-amplifier has a bandwidth from DC to 4 MHz. The  $-3\text{dB}$  frequency of the cross-over filter lies at 100 kHz. In this way a split-band amplifier is obtained with a bandwidth from DC to 100 MHz.

The advantages of the split-band amplifier are:

### a. lower noise

H.F. transistors suffer from a serious  $1/f$  noise at frequencies lower than approx. 100 kHz. L.F. transistors cause a serious noise at higher frequencies. Moreover, they do not meet the rise-time requirements. In the split-band amplifier the best properties of the transistors are used, each in their own frequency range.

### b. better DC biasing

In a split-band amplifier it is possible to adjust the transistors to their optimum collector-current i.e. for H.F. transistors to approx. 10 mA, for L.F. transistors to approx. 1 mA.

### c. No necessity for constant dissipation networks

As the time-constant of the thermal processes in

the H.F. transistors amounts to several milliseconds and the H.F. amplifier is followed by a 100 kHz high-pass filter, there is no necessity to provide the H.F. amplifier with constant dissipation networks.

### d. Better decoupling of the supply-voltages

As RC coupling is used, it is only necessary to have one common power supply. The supply per stage is sufficiently decoupled without impairing the L.F. square-wave response. To avoid undue interstage coupling the emitter resistors are connected to earth.

It is possible to switch off the AC amplifier with switch SK1 so that a DC amplifier remains with a bandwidth of 0...100 kHz, without HF noise.

At the 4 smallest deflection coefficients - 5 mV/cm to 0,5 mV/cm - the amplification factor of the split-band amplifier is increased by decreasing the negative feedback. A convenient deflection can be selected with switch SK4.

For the larger values, attenuator networks are inserted between the input terminal and the pre-amplifier. The DC-amplifier is provided with a control circuit (chopper amplifier) which counteracts DC drift.

The final amplifier, contrary to the pre-amplifier, is entirely push-pull connected. The output of the final amplifier is routed to both the Y-amplifier and the trigger amplifier of the basic oscilloscope.

# Principles of the control-loop



The input circuit of the DC amplifier consists of a differential amplifier. Input I receives signal  $V_i$ ; input II receives the control signal  $V_c$ . All drift-voltages are referred to input I where they are assumed to come from a voltage-source  $V_d$  (Fig. 9).

Output  $V_o$  of the DC-amplifier is attenuated by a factor A at the 1/A attenuator. At one side of voltage divider  $R1 = R2 = 1.11 \text{ Mohm}$ , voltage  $V_i$  is fed in and at the other side voltage  $V_o/A$ ; therefore, the input of the chopper amplifier will be  $\frac{1}{2}(V_i + V_o/A)$ .

After amplification, control voltage  $V_c$  amounts to:

$$V_c = -\frac{1}{2} B (V_i + V_o/A).$$

At terminal I the input stage of the DC-amplifier receives a voltage equal to  $V_i + V_d$  and at termi-

nal II voltage  $V_c$ . The difference is amplified ( $-A$ ) times so output  $V_o$  amounts to:

$$V_o = -A (V_i + V_d) - [-\frac{1}{2} B (V_i + V_o/A)]$$

extracting  $V_o$  gives:

$$V_o = -A (V_i + \frac{V_d}{1 + \frac{1}{2}B})$$

As  $B \approx 2000$ , it is clear that drift  $V_d$  is reduced by a factor  $\approx 1000$ .

If SK3 is in position "AC", capacitor C102 is inserted in series with R1 so voltage divider R1—R2 is blocked for DC. Any leakage voltage of C26 is added to  $V_d$  but now the "new" drift voltage  $V_d'$  will

be reduced by a factor  $\frac{1}{1 + B}$ .

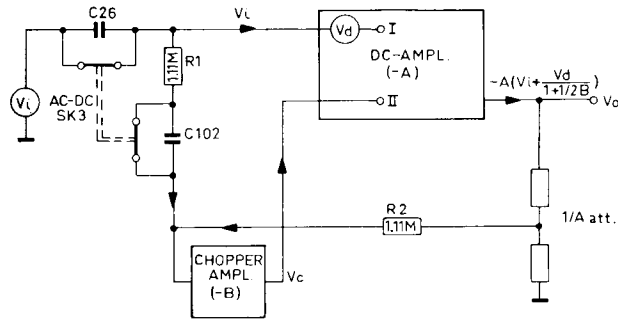

Fig. 9. Controlloop



## Circuit description

### A. INPUT CIRCUIT (Fig. 23)

When the AC—DC switch SK3 is in position “AC” it is possible to observe small AC signals superimposed on a maximal 400 V DC-voltage. At the same time relay RE101 is energised which switches capacitor C102 into comparison circuit R1—R2 (Fig. 9). In this way any DC component at the input circuit which may be due, among other things, to the leakage of C26, is compensated by the action of the chopper amplifier.

In the “AC” position of SK3, blocking capacitor C26 may be charged by a DC input voltage. On switching over to position “DC” the capacitor is discharged to prevent the charge of C26 from destroying any delicate test object when switching over again from DC to AC.

When the step attenuator is put at the 4 smallest deflection-coefficients (0,5, 1, 2, 5 mV/cm) the input signal is not attenuated. Trimmers C18-C21-C24-C29 allow the input capacitance to be adjusted to precisely 15 pF. For the larger deflection coefficients, attenuator networks are inserted between the input terminal and the cathode follower B101. With trimmers C33-C36-C39-C43-C47-C51-C54-C58, the input capacitance can be adjusted to 15 pF. Trimmers C32-C34-C38-C42-C46-C49-C53-C57 allow an adjustment for optimum square-wave response.

The 1.11 Mohm resistor consists of the resistors R103 (1 Mohm) and R102 (110 Kohm). This value is chosen to obtain a 1 Mohm input resistance because a grid-current compensating network with a 10 Mohm source resistor (R104) is connected at this point, and it is parallel to the 1.11 Mohm resistance. The grid-current compensating network consisting of resistors R106-R107-R110-R115 and potentiometer R108 delivers a positive or negative current, depending on the position of R108. This current is required for cathode follower stage B101, which supplies the input signal to the split-band amplifier via overload-protecting diodes GR104-GR106.

Push-button SK2 disconnects the input signal and earths the grid of the cathode-follower, to indicate the zero-level of the display.

Diodes GR101 and GR102 protect the chopper amplifier when the DC part of the split-band amplifier is overdriven.

### B. HF-AMPLIFIER (Fig. 26)

The AC components of the input signal are fed into the HF amplifier via emitter-follower TS102. The three nearly identical stages consist of an ordinary emitter-amplifier and an emitter-follower.

Each stage provides an output which is in anti-phase with respect to its input. As a whole the HF-amplifier provides a 180 degrees phase-shift to match the output of the DC-amplifier.

In the positions “2 - 1 - .5 mV/cm” of SK4 the gain of the H.F. amplifier is increased by decreasing the current feedback respectively at the 3rd, 2nd and 1st stage. At these positions of SK4 the gain can be matched to that of the DC amplifier by selecting resistors as tabulated below.

Position of SK4	Resistor	
	Coarse	Fine
5 mV/cm	R138	R139
2 mV/cm	R173	R174
1 mV/cm	R158	R159
.5 mV/cm	R143	R144

If the measurements permit this, the HF-amplifier can be taken out of operation by throwing switch SK1 which cuts off only the power supply of the second stage.

### C. DC-AMPLIFIER (Fig. 26)

The DC and LF-components of the input signal enter the DC coupled amplifier at the base of TS113, which is part of difference amplifier TS112 – TS114. The correction voltage delivered by the chopper-amplifier enters at the other emitter-follower (TS111). The difference of the two signals is fed, via emitter-follower TS116, to two more stages, which consist of an amplifier and an emitter-follower. At the last stage, zener-diode GR107 provides a low impedance step-down of the DC level.

When the most sensitive deflection coefficients are selected, SK4 reduces the emitter resistance of TS117 thus increasing stepwise the overall gain of the DC-amplifier from 10 x to 25 x, 50 x and 100 x. An exact match with the 1/A attenuator can be carried out by adjusting potentiometer R208.

### D. INTERSTAGE NETWORK (Fig. 26)

The outputs of the HF-amplifier and the DC amplifier are combined in cross-over filter R216 – C157 and fed to emitter-follower TS401. The 1/A attenuator is connected to the emitter of TS401. It consists of precision resistors R406 – R408 – R409 – R411 and R412. Its output is fed to the chopper amplifier via the 1.11 Mohm resistors R300 – R301. The

continuous gain control R2 is also connected to the emitter of TS401.

The output impedance of the two amplifiers is very small compared with the impedance of R216 - C157. This means that, seen from the HF amplifier C157 + R216 act as a high-pass filter with a cross-over frequency of 100 kHz, thus suppressing low frequency noise components and other spurious low frequency signals, generated in the HF amplifier (Fig. 10). Seen from the LF amplifier, however, R216 + C157 act as a low-pass filter with a cross-over frequency of 100 kHz, suppressing high frequency noise components and other high frequency signals generated in the LF amplifier.

An input signal  $V_i$  applied to the split-band amplifier (see Fig. 11) causes an output signal  $\alpha_1 V_i$  at "a" and an output signal  $\alpha_2 V_i$  at "b" ( $\alpha_1$  and  $\alpha_2$  denoting the gain of respectively the HF amplifier and the LF amplifier).

At frequencies where  $\alpha_1 \approx \alpha_2 \approx \alpha$  ( $\alpha$  denoting the desired overall gain) the output at "a" equals the output at "b", thus no current will flow through the interstage network. Then the output at "C" equals  $\alpha V_i$ .

At low frequencies,  $\alpha_1$  is smaller than  $\alpha_2$  and  $\alpha_2$  equals  $\alpha$ . Now the output at "a" is smaller than the output at "b" so a current will flow through R216 and C157, which causes R216 - C157 to act as a low-pass filter to the output at "b". As  $\alpha_2 V_i = \alpha V_i$  the output at "C" equals the output at "b".

At high frequencies,  $\alpha_2$  is smaller than  $\alpha_1$  and  $\alpha_1$  equals  $\alpha$ .

Now the output at "b" is smaller than the output at "a", so a current will flow through R216 and C157, which causes R216 - C157 to act as a high-pass filter to the output at "a". As  $\alpha_1 V_i = \alpha V_i$  the output at "c" equals the output at "a".

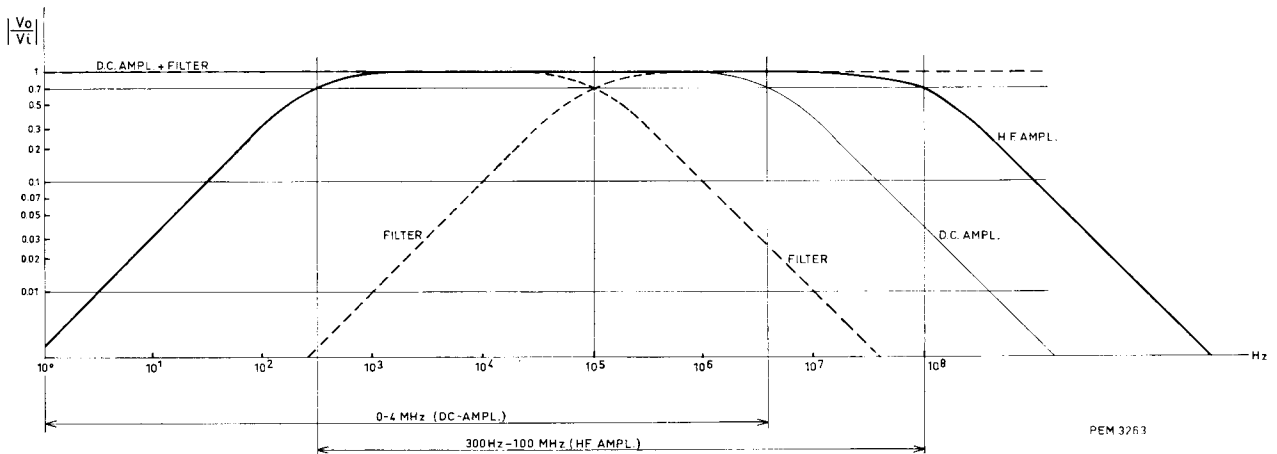

Fig. 10. Bandwidth characteristics

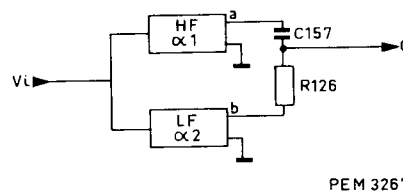

Fig. 11. Operation of the cross-over filter



**E. CHOPPER AMPLIFIER (Fig. 24)**

The chopper amplifier consists of:

1. the 400 Hz oscillator
2. the chopper
3. the amplifier
4. the demodulator.

The oscillator is an inductively fed-back push-pull oscillator which is tuned to 400 Hz by fixed capacitor C313 and the adjustable inductance of transformer L302. Its output drives the chopper directly, and the demodulator via a phase-shifting network. A DC voltage caused by the drift is applied to terminal 1 of the chopper. The latter switches the input of the amplifier alternately to this voltage and earth (at terminal 3) so the input receives a square wave voltage. In order to avoid hum, the earthing of the chopper is carried out at a single point near input cathode-follower B101.

The square-wave input-signal is amplified about 120x in stage TS301 – TS302 – TS303, the AC-amplification being determined mainly by the relation R311 : R309. The DC-amplification is determined by the relation R311 : (R309 + R308) which amounts to about 1 : 1.

The next stage consisting of TS304 – TS306 gives a further 20x amplification for AC, but a 2 : 1 reduction for DC; so DC-variations have hardly any influence on the stability of the control circuit.

Via emitter-follower TS306, the chopped signal is fed to the phase-sensitive detector which contains the symmetrical NPN transistors TS307 – TS308 – TS309 – TS311.

The driving voltage of the detector is generated at two separate windings of transformer L301 which receives its primary voltage from the chopper driving source.

By the action of the collector-to-base diode of the transistors a biasing voltage builds up across capacitors C308 and C309, the charge of which can leak away across resistors R322 and R323. During the crests of the sinusoidal driving voltage the charge is supplemented until the biasing voltage equals the driving voltage, so during those times a base-current exists, which makes the transistors conductive.

In this way, there is a change-over switch which operates synchronous with the chopper; network R332 – C317 provides the necessary phase-shift to be sure that the contact is made when the top of the square-wave is steady.

In the simplified diagram (Fig. 12) the demodulator is represented by a switch which connects capacitor C307 to capacitor C311 or earth. The switch makes a momentary contact under influence of the earlier mentioned biasing voltage.

From Fig. 12 it is clear that the polarity of the voltage over C311 will be inverse to that of the input voltage, due to the phase reversal of the amplifier. The amplitude virtually equals the peak to peak value of the amplifier output being insensitive to variations of the mean value, which could be caused by variations of the chopper duty cycle.

As the output may be either positive or negative, symmetrical transistors are used for the demodulator as they allow a bidirectional current flow as long as base-current is present. The AC earthing of the demodulator is carried out by capacitor C164. Potentiometer R187 allows the balance adjustment of the differential (first) stage of the DC amplifier. Once correctly adjusted, the balance will be maintained by the control-circuit.

The interconnection of the 1.11 Mohm resistors can be seen as a virtual earth and, as a consequence, the input resistance of the DC-amplifier will not change due to the action of the chopper amplifier.

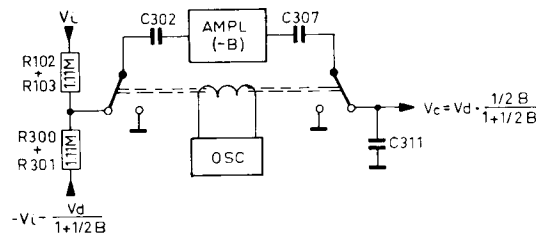

PEM 3141

Fig. 12. Operation of the demodulator

## F. FINAL AMPLIFIER (Fig. 25)

The input stage of the final amplifier consists of an asymmetrically driven long-tailed pair. The signal enters via emitter-follower TS402 at the base of TS404. The shift control enters via TS403 at the base of TS406.

At the emitter side of the long-tailed pair, screw-driver-set potentiometer R1 enables a vernier adjustment of the deflection coefficient. With trimmer C416 the rise-time can be adjusted to optimum. The output stage is provided with two complementary pairs of emitter-followers.

They allow for both fast rise and fall when displaying a squarewave, in spite of the capacitance load, present at the input of the Y-amplifier and the trigger-amplifier.

The signals enter via forward biased diodes whose standing current can be adjusted by R449 respectively R457. If, for instance, the voltage at the collector of TS404 rises, the current through GR403

decreases and the current through GR404 increases. This gives rise to an increase of the base-current of the NPN transistor TS407 which will become more conductive; so the output will become more positive. The increase of the current through GR404 causes a decrease of the base-current of PNP transistor TS408, which will become less conductive, offering a higher impedance to the NPN emitter-follower. As a whole, the capacitance present at the output of the final amplifier will be charged rapidly from a low ohmic current source.

At the time that the voltage at the collector of TS404 rises, the voltage at the collector of TS406 falls. The current through GR406 will decrease, thus opening PNP transistors TS409.

The output capacitance will be discharged rapidly through this low ohmic path.

The output voltage of the final amplifier is offered directly to the Y-amplifier of the basic oscilloscope via terminals 1BU-Y and 17BU-Y. The trigger-amplifier receives the same voltages via R236 and R237 next to terminals 16BU-Y and 32BU-Y.

## Checking and adjusting

### GENERAL INFORMATION

The tolerances mentioned are factory tolerances; they apply when the apparatus is readjusted completely. They may differ from the data given in chapter I.

A summary of the adjusting elements, their nomenclature and location has been given in chapter IV.

With the aid of these data, it is possible to carry out all the adjustments of low drift unit PM 3332 and to check the proper working of the plug-in unit. For this the unit should be inserted into the Y-plug-in compartment of a correctly adjusted basic oscilloscope PM 3330.

Some of the adjusting elements are on the right-hand side of the unit and are not directly accessible. When these elements should be adjusted, the unit should be connected to the basic oscilloscope via the rigid extension plug (for the code number of this plug, see the list of accessories of PM 3330).

For a complete adjustment of the instrument the sequence as described in this chapter is to be preferred.

### A. CHECK OF THE CHOPPER-AMPLIFIER

It is possible to remove the chopper-amplifier from its housing after removing lid "A" (Fig. 13) and a four pin plug, a three pin plug and a single pin plug. If measurements are carried out when the amplifier is out of its housing, it should be carefully screened to avoid hum.

- Connect the positive pole of a 24 V supply to earth and to the green wire on the 4 pin plug. The negative pole should be connected to the black wire on the 4 pin plug.
- Adjust the oscillator frequency to approx 400 Hz by screwing in or out the core of coil L302.
- Apply a 1 mV negative voltage (with the aid of a suitable voltage divider and the 12 V power supply or a separate dry cell) to pin "1" of the 3-pin plug. Connect pin "2" to the "common" of the voltage divider and earth pin "3" by connecting it to the green wire of the 4-pin plug.

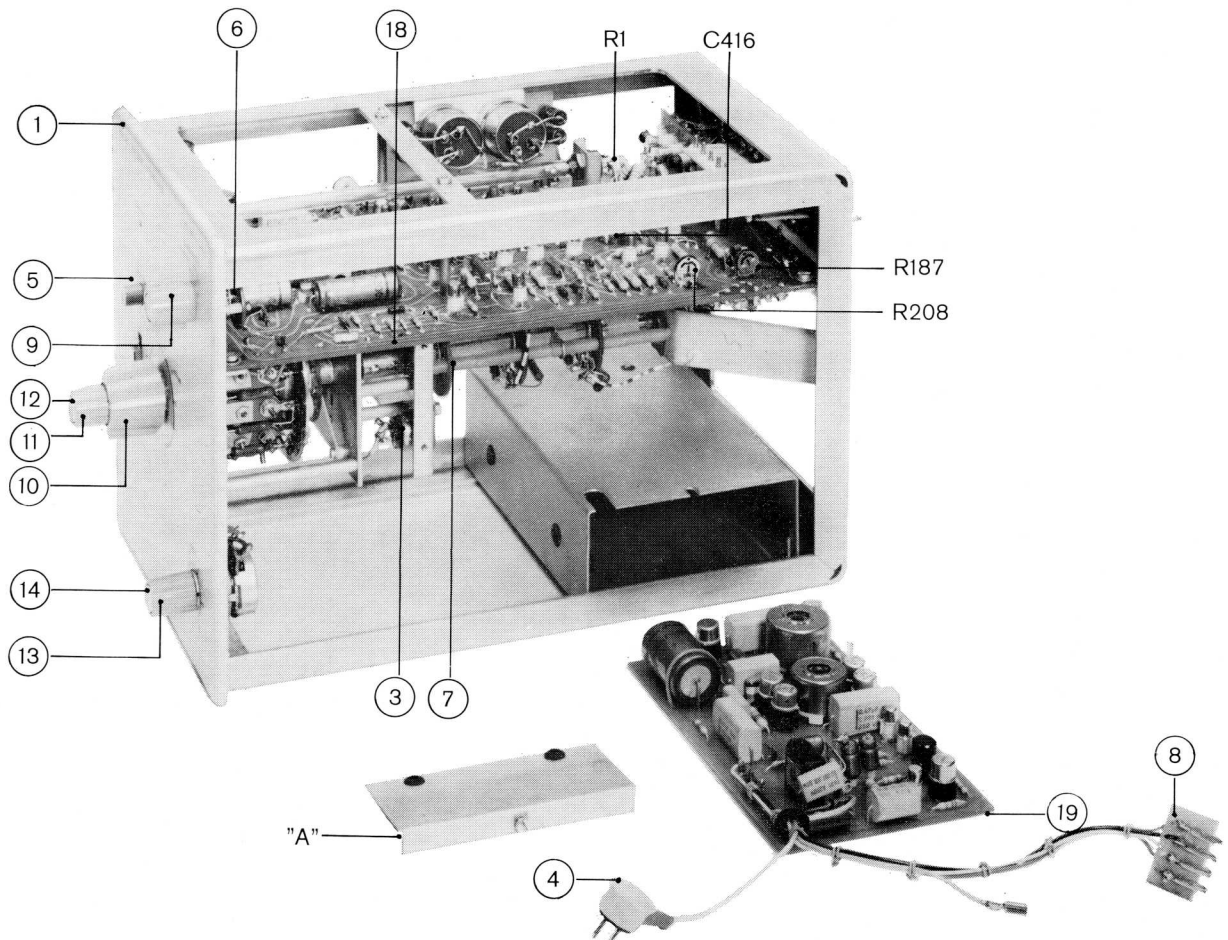

Fig. 13. Right-hand view

- Apply a load-resistance of 1 Mohm to the 2 remaining pins of the 4-pin plug. The voltage developed across this resistance should amount to a value between 2 and 2.5 V. The brown wire should be negative with respect to the orange one.
- Increase the input voltage to 3 mV. The output should be equal to 5 V or exceed that value.
- Change the polarity of the input voltage; the output voltage should be equal to or exceed 5 V, if possible, equal to the value, stated at the previous measurement.
- Remove the voltage from the 3-pin plug and interconnect pin "2" and pin "3". The output should be equal to or smaller than 20 mV.
- The noise across resistor R317 should be  $\leq 10$  mVrms.
- Remove the interconnection. Now the noise may not exceed 50 mVrms.

**Note:** If one of the last two requirements is not met, the input transistor TS301 (2N930) should be replaced.

## B. GRID-CURRENT COMPENSATION R108 (Fig. 14)

- Set the knobs of the basic oscilloscope to the following positions:

"TRIGG. MODE" : "AUT"  
 "TRIGG. SOURCE" : "INT"  
 "TIME/cm" : "5 msec./cm"  
 "X-DEFLECTION" : "TIME BASE A"

- At the unit, set "V/cm" (SK4) to "0.5 mV/cm" and (R2) to "CAL."
- Adjust "SHIFT" (R3) so that the trace is in the middle of the screen. Short circuit the input connector.
- Adjust "Ig. COMP" (R108) so that the trace does not jump when button "CHECK ZERO" (SK2) is depressed.

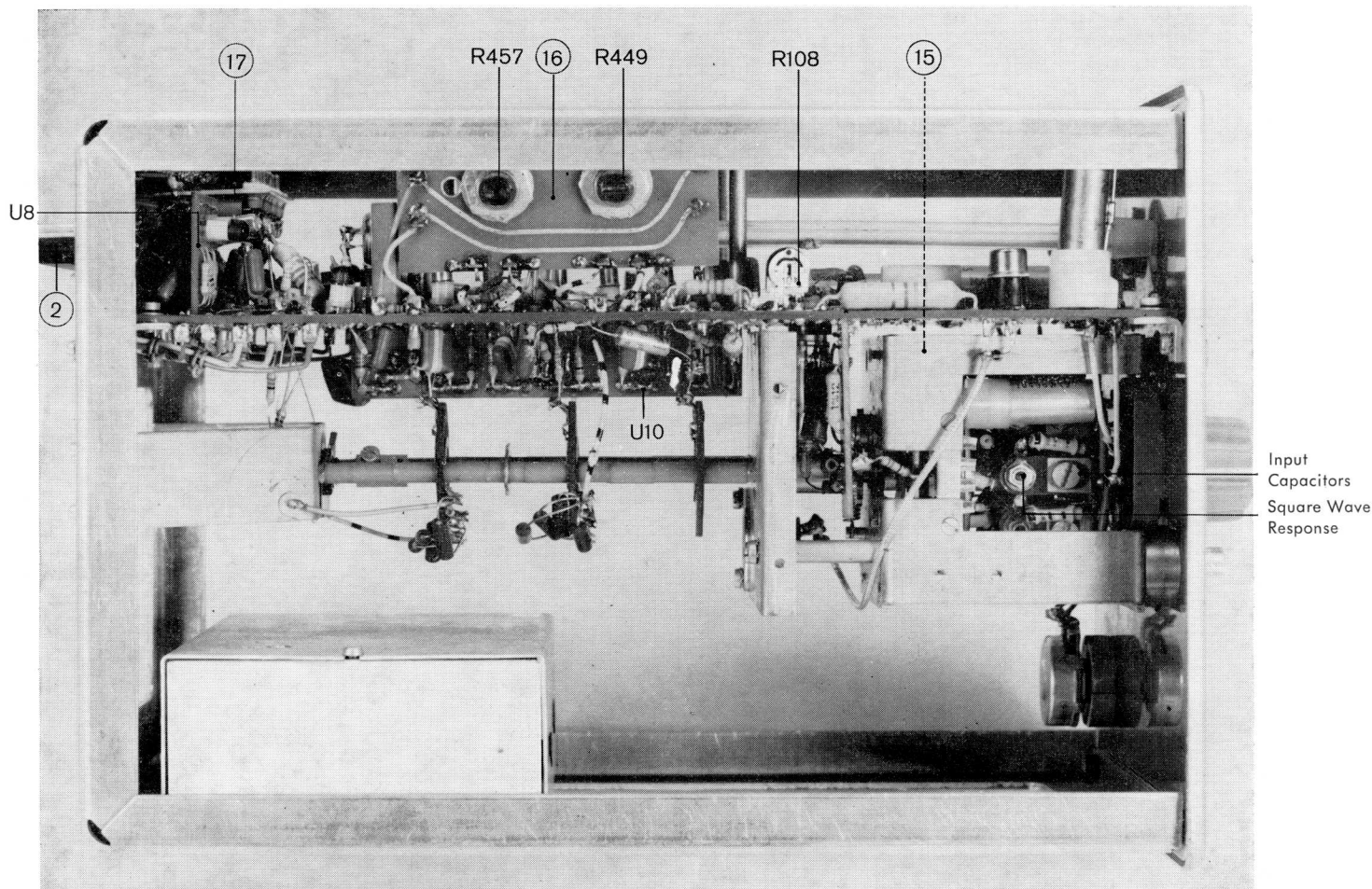

Fig. 14. Left-hand view

**C. BALANCE ADJUSTMENT**

**R187 (Fig. 13)**

Before carrying out this measurement connect unit PM 3332 to the basic oscilloscope with the extension cable (see list of accessories of PM 3330).

- Set “V/cm” (SK4) to “0,5 mV/cm”. Keeping “CHECK ZERO” (SK3) depressed, turn “V/cm” (R2) quickly to and fro. If the trace is moving vertically, adjust R187 until the trace is stationary.

**D. SQUARE WAVE RESPONSE**

**R208 (Fig. 13). C416 (Fig. 13)**

**R138-R139-R143-R144**  
**R158-R159-R173-R174** } (Fig. 21)

Apply the rigid extension plug and set “V/cm” (SK4) to “5 mV/cm”. Turn potentiometers “GAIN ADJ” (R1) and “V/cm” (R2) fully anticlockwise; set “AC-DC” (SK3) to “DC”.

- Apply a square wave with a 10 Hz repetition frequency and such an amplitude as to obtain a 4 cm trace height.
- Adjust R208 to that the square wave has a flat top.
- Increase the frequency to 100 kHz with an amplitude of 20 mV<sub>p-p</sub>. To obtain an optimum square-wave response the gain of the H.F. amplifier should be made equal to that of the DC amplifier. This can be obtained by changing the value of several emitter resistors according to the next table.

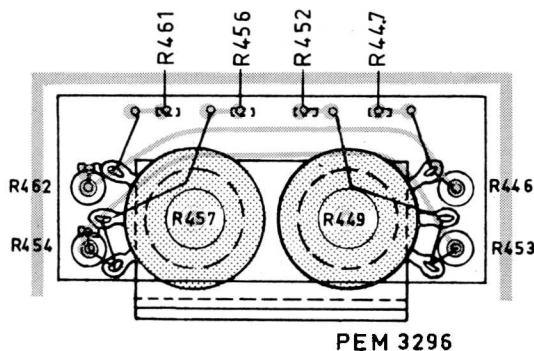

Item 16 of fig. 14

Position of SK3	Amplitude of the 100 kHz signal	Choice resistor coarse	Choice resistor fine
5 mV/cm	20 mV <sub>p-p</sub>	R138	R139
2 mV/cm	8 mV <sub>p-p</sub>	R174	R173
1 mV/cm	4 mV <sub>p-p</sub>	R159	R158
0.5 mV/cm	2 mV <sub>p-p</sub>	R144	R143

**Note:** With choice resistor “coarse” adjust the display so that some rounding off is present; with choice resistor “fine” adjust the display so that just no overshoot occurs.

- Remove the extension plug und apply a square wave with a 1.5 nsec. rise time.

This can be obtained by connecting a tunnel-diode pulse shaper to the calibration voltage. If a Tektronix TU-5 unit (cat. number 015-0038-00) is used, it should be adapted to the 80 V calibration voltage by connecting a 2700 ohm (0.1 Watt, 5%) resistor parallel to the 3300 ohm resistor of the unit (see Fig. 15).

Connect the pulser to the input terminal of the amplifier via a 5 : 1 and a 2½ : 1 attenuator (e.g. Tektronix 011-0060-00 resp. 011-0076-00) and a 50 ohm termination pad. (e.g. XE 101.96).

- Set the knobs of the basic oscilloscope to the following positions:

- “TRIGG. MODE” : “H.F.”
- “TRIGG. SOURCE” : “INT”
- “TIME/cm” : 0.05 μsec/cm
- “MAGN” : × 5

- Set the knob of the PM 3332 “V/cm” (SK4) to “5 mV/cm”.
- With trimmer C416 adjust for a minimum rise time.

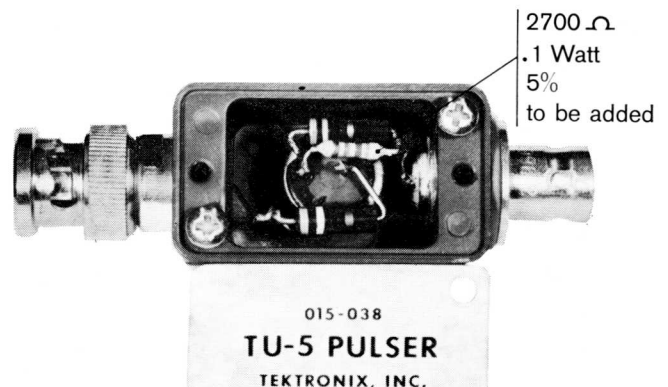

Fig. 15. Pulser

### E. DEFLECTION COEFFICIENT

- Set “V/cm” (SK4) to “5 mV/cm” and “V/cm” (R2) to “CAL.”.
- Apply a 20 mV calibration voltage to the input of the plug-in unit.
- Adjust “GAIN ADJ.” (R1) so that the trace-height amounts to precisely 40 mm.
- It should be possible to reduce the trace height to less than 16 mm with “V/cm” (R2).

### F. FREQUENCY RESPONSE CURVE

After adjusting the square wave response (point D) and the deflection coefficient (point E) the  $-3$  dB point of the unit should lie at a frequency of more than 50 MHz.

The frequency response curve can be measured with e.g. the PHILIPS A.M./F.M.-generator GM 2621 and the PHILIPS H.F.-millivoltmeter GM 6025. The latter is to check that the input voltage remains constant at the various frequencies.

- Set “X-deflection” (SK7) on the basic oscilloscope to “50 Hz”.
- Set “V/cm” (SK4) on the unit to “5 mV/cm” and “V/cm” (R2) to “CAL.”.
- Connect the output connector HF II with a terminated 50-Ohm cable to a T-piece which takes in the HF probe of the millivoltmeter. Apply the T-piece to the input terminal of the plug-in unit.
- Switch the generator frequency to 10 MHz and adjust the voltage to a 40 mm trace height. Note the indication of the millivoltmeter.
- Increase the frequency to 50 MHz and adjust the amplitude to the same value as noted before.
- The trace height should exceed 28 mm.

### G. DEFLECTION AND SHIFT

Before carrying out this measurement, check that the DC balance and the sensitivity have been correctly adjusted (see point C and E).

- Set the “AC/DC” switch (SK3) to “AC”, “V/cm” (SK4) to “5 mV/cm” and “V/cm” (R2) to “CAL.”.
- Set “TIME/cm” on the basic oscilloscope to “0.2 msec/cm”.
- Apply a triangular (or sinusoidal) signal with a frequency of 2 kHz and an amplitude of 90 mV<sub>p-p</sub>.
- The control range of “SHIFT” (R3) should be so large, that the tops of the trace can be brought within the measuring graticule.
- With this triple overdriving, no distortion of the trace should occur.

### H. AC/DC SWITCH; CHECK ZERO

- Set the below mentioned knobs to the following positions:
    - “AC/DC” (SK3) to “DC”
    - “V/cm” (SK4) to “5 mV/cm”
    - “V/cm” (R2) to “CAL.”.
  - Apply a 20 mV calibration voltage to the input of the plug-in unit.
  - Adjust “SHIFT” (R3) so that the lower side of the trace coincides with the centre line of the screen.
  - Set SK3 to “AC”.
- The DC components of the calibration voltage should be blocked, as a result of which the trace is written approximately symmetrically around the centre line of the screen.
- Slowly depress button “Check Zero” (SK2). First the signal should be visible in its differentiated form and next, it should disappear completely.

### I. INPUT ATTENUATOR

#### 1. Attenuation and square wave response

For the adjustment of the attenuator, in every position of “V/cm” (SK4), the corresponding trimmers are accessible via holes in the screening plate (see Fig. 14).

- Apply the calibration voltage of the basic oscilloscope to the input of the PM 3332.
- After correct adjustment of the deflection coefficient (see point E) the trace height should amount to precisely 40 mm.
- Check the trace height in all other positions of SK4 according to the table below; the trace height should amount to 40 mm, + or  $-2\%$ .
- At the same time, adjust the trimmers mentioned in the table for optimum square wave response.

Calibration voltage	V/cm (SK4)	Trimmer
2 mV	0.5 mV/cm	—
4	1	—
8	2	—
20	5	—
40	10	C31
80	20	C34
0.2 V	50	C38
0.4	0.1 V/cm	C42
0.8	0.2	C46
2	0.5	C49
4	1	C53
8	2	C57

## 2. Input capacitance

With the aid of an input RC standardiser (Fig. 16) (e.g. Tektronix cat. number 011-0073-00 BNC) the input capacitance can be adjusted to 15 pF in all positions of SK4.

- Apply the calibration voltage of the basic oscilloscope to the input of the unit via the input RC standardiser.
- Adjust the input capacitance by means of the trimmers mentioned in the tabel below so that the square wave response is optimum.

Calibration voltage	V/cm (SK4)	Trimmer
4 mV	0.5 mV/cm	C18
8	1	C21
20	2	C24
40	5	C29
80	10	C33
0.2 V	20	C36
0.4	50	C39
0.8	0.1 V/cm	C43
2	0.2	C47
4	0.5	C51
8	1	C54
20	2	C58

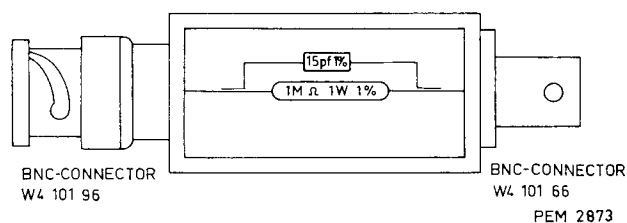

Fig. 16. Input RC standardiser

## List of service parts



### A. MECHANICAL PARTS

<i>Item</i>	<i>Fig.</i>	<i>Code number</i>	<i>Description</i>	<i>Qty.</i>	<i>S</i>
1	13	4822 454 40035	Textplate	1	**
2	14	W4 125 73	Connector	1	*
3	13	979/5 x 180	Socket	1	*
4	13	4822 211 00854	Plug	1	*
5	13	4822 159 00445	Push button	1	**
6	13	4822 273 30133	Switch SK1	1	*
7	13	4822 273 70013	Switch SK4	1	*
8	13	4822 265 40037	Plug (panel)	1	*
9	13	4822 159 00321	Knob	1	**
10	13	4822 159 00318	Knob	1	**
11	13	4822 159 00359	Knob	1	**
12	13	4822 159 00358	Cap	1	**
13	13	4822 159 00315	Knob	1	**
14	13	4822 159 00314	Cap	2	**
15	14	4822 105 30039	Unit 4 (Attenuator)	1	*
16	14	4822 214 10032	Unit 6 (Output adjustment)	1	*
17	14	4822 214 10033	Unit 7 (Supply filter)	1	*
18	13	4822 214 10034	Unit 11 (Amplifier)	1	*
19	13	4822 214 10035	Unit 12 (Chopper amplifier)	1	*

### PURPOSE OF THE COLUMN "S"

#### — Components not marked

They should be present at the Service Department in the country concerned or at the customer who is using the apparatus.

They include:

- a. all electrical components;
- b. mechanical parts which are vulnerable, or which are subject to wear.

a. the number of equipment present in the country concerned;

b. the necessity of having the apparatus working continuously or not;

c. the time of delivery of the components with respect to the import restrictions in the country concerned and the duration of the transport.

#### — Components marked with one star

These components generally have a long or unlimited service-life, but their presence is essential for the correct working of the apparatus. Stocking up of a few of these components depends on the following factors:

#### — Components marked with two stars

These components have a long or unlimited service-life and they are not essential for the correct working of the apparatus. Generally they are not stocked locally.



















## B. ELECTRICAL PARTS

No standard parts are included in this parts list with the exception of choice resistors.



The standard parts in the circuit diagrams are indicated with symbols from which the service code number can be derived.

The key to the code is given below:

	Carbon resistor	0.25	W	$\leq 1 \text{ M}\Omega$ : 5% $> 1 \text{ M}\Omega$ : 10%	902/K.....
	Carbon resistor	1	W	$\leq 2.2 \text{ M}\Omega$ : 5% $> 2.2 \text{ M}\Omega$ : 10%	900/P.....
	Carbon resistor	0.5	W	$\leq 10 \text{ M}\Omega$ : 1% $> 10 \text{ M}\Omega$ : 2%	901/.....
	Wire-wound resistor	0.4—1.8	W	0.5%	901/W.....
	Carbon resistor	0.5	W	$\leq 1.5 \text{ M}\Omega$ : 5% $> 1.5 \text{ M}\Omega$ : 10%	902/P.....
	Wire-wound resistor	5.5	W	$\leq 270 \Omega$ : 10% $> 270 \Omega$ : 5%	938/A.....
	Wire-wound resistor	10	W	5%	938/B.....
	Carbon resistor	0.125	W	5%	902/A.....

	Ceramic capacitor	500—700	V		904/.....
	Ceramic "Pin-up" capacitor	500	V		904/P.....
	Styroflex capacitor	500	V	1%	905/D.....
	Polyester capacitor	400	V	10%	906/.....
	Paper capacitor	1000	V	10%	906/V.....
	Wire-wound trimmer				907/.....
	Ceramic trimmer ( $\leq 22\text{E}$ ) Air trimmer ( $\geq 30\text{E}$ )				908/.....
	Air trimmer (for printed-wiring boards)				908/P.....

### Example:

	Code number	901/120K
	Code number	904/4E7

The correct values of the choice-resistors and capacitors are determined during factory adjustment. All resistors are vaporised carbon resistors, unless otherwise specified.

## RESISTORS

<i>Number</i>	<i>Code number</i>	<i>Value</i>		<i>Watts</i>	<i>%</i>	<i>Description</i>
R1	4822 100 20011	500	ohm			Potentiometer
R2	4822 100 20013	100	ohm			Potentiometer
R3	916/GE10K	10	kohm			Potentiometer
R26	B8 305 80B/10K	10	kohm	0.1	1	Carbon
R29	B8 305 23D/500K	500	kohm	0.1	1	Carbon
R31	B8 305 23D/1M	1	Mohm	0.1	1	Carbon
R32	B8 305 23D/750K	750	kohm	0.1	1	Carbon
R33	B8 305 26D/333K	333	kohm	0.1	1	Carbon
R34	B8 305 23D/900K	900	kohm	0.1	1	Carbon
R36	B8 305 23D/111K	111	kohm	0.1	1	Carbon
R37	B8 305 23D/950K	950	kohm	0.1	1	Carbon
R38	B8 305 23D/52K6	52.6	kohm	0.1	1	Carbon
R39	4822 111 20253	975	kohm	0.1	1	Carbon
R41	4822 111 20254	25.6	kohm	0.1	1	Carbon
R42	B8 305 23D/990K	990	kohm	0.1	1	Carbon
R43	B8 305 23D/10K1	10.1	kohm	0.1	1	Carbon
R44	4822 111 20237	995	kohm	0.1	1	Carbon
R46	4822 111 20238	5.03	kohm	0.1	1	Carbon
R47	4822 111 20239	998	kohm	0.1	1	Carbon
R48	4822 111 20255	2.50	kohm	0.1	1	Carbon
R102	4822 116 50198	110	kohm	0.125	1	Carbon
R103	4822 071 00779	1	Mohm	0.25	1	Metal film
R104	901/10M	10	Mohm	0.1	1	Carbon
R108	4822 100 10035	10	kohm			Potentiometer
R126	4822 111 50241	15	kohm	1		Carbon
R134	901/330E	330	ohm	0.05	5	Carbon
R137	901/82E	82	ohm	0.05	5	Carbon
R152	901/330E	330	ohm	0.05	5	Carbon
R154	B8 305 39D/150E	150	ohm	0.05	5	Carbon
R157	B8 305 39D/99E	99	ohm	0.05	5	Carbon
R167	901/330E	330	ohm	0.05	5	Carbon
R169	B8 305 39D/150E	150	ohm	0.05	5	Carbon
R182	902/K2M2	2.2	Mohm	0.1	5	Carbon
R187	4822 100 10057	100	ohm			Potentiometer
R191	901/680E	680	ohm	0.05	5	Carbon
R199	4822 071 00753	6.8	kohm	0.125	1	Metal film
R201	4822 116 50225	590	ohm	0.125	1	Metal film
R202	4822 116 50226	780	ohm	0.125	1	Metal film
R203	4822 116 50227	2.28	kohm	0.125	1	Metal film
R205	4822 071 00837 (2 par)	28	kohm	0.125	1	Metal film
R208	4822 100 10035	10	kohm			Potentiometer
R300	4822 071 00779	1	Mohm	0.25	1	Metal film
R301	4822 116 50198	110	kohm	0.125	1	Carbon
R406	4822 116 50228	98.9	kohm	0.125	1	Metal film
R408	4822 071 00764	1	kohm	0.125	1	Metal film
R409	4822 116 50229	1.02	kohm	0.125	1	Metal film
R411	4822 116 50231	2.12	kohm	0.125	1	Metal film
R412	4822 116 50232	6.96	kohm	0.125	1	Metal film
R417	B8 305 39D/99E	99	ohm	0.05	5	Carbon
R446	938/A15K	15	kohm	5.5	10	Wire wound
R447	4822 071 00971	33	kohm	0.25	5	Carbon
R457	4822 071 01055	22	kohm			Potentiometer
R461	4822 071 00971	33	kohm	0.25	5	Carbon
R462	938/A15K	15	kohm	5.5	10	Wire wound
R142	B8 305 39D/99E	99	ohm	0.05	5	Carbon

## CAPACITORS

<i>Number</i>	<i>Code number</i>	<i>Value</i>	<i>Volts</i>	<i>Description</i>
C18, 21, 24	4822 125 60045	68 pF		Trimmer (cer)
C29, 32, 33	4822 125 60045	68 pF		Trimmer (cer)
C34, 36, 38	4822 125 60045	68 pF		Trimmer (cer)
C39, 42, 43	4822 125 60045	68 pF		Trimmer (cer)
C46, 47, 49	4822 125 60045	68 pF		Trimmer (cer)
C51, 53, 54	4822 125 60045	68 pF		Trimmer (cer)
C57, 58, 61	4822 125 60045	68 pF		Trimmer (cer)
C62	4822 125 60045	68 pF		Trimmer (cer)
C26	4822 121 20085	0.1 $\mu$ F	300	Paper
C37	905/D9E1	9.1 pF	500	Ceramic
C41	4822 123 10165	27 pF	300	Button
C44	4822 123 10166	56 pF	300	Button
C48	4822 123 10167	150 pF	300	Button
C52	4822 123 10168	300 pF	300	Button
C56	4822 123 10169	600 pF	300	Button
C59	4822 123 10171	1500 pF	300	Button
C63	4822 123 10172	2400 pF	300	Button
C101	909/W250	250 $\mu$ F	10	Electrolytic
C102	4822 121 40095	0.12 $\mu$ F	250	Polyester
C104	4822 609 01127	20 $\mu$ F	100	Electrolytic
C107, 109, 111	4822 069 01103	0.068 $\mu$ F	250	Plate
C114, 118, 121	4822 069 01103	0.068 $\mu$ F	250	Plate
C128, 133, 138	4822 069 01103	0.068 $\mu$ F	250	Plate
C144, 149, 156	4822 069 01103	0.068 $\mu$ F	250	Plate
C112, 113, 123	4822 124 20191	10 $\mu$ F	200	Electrolytic
C116, 126, 131	4822 069 01034	4,7 $\mu$ F	35	Tantalum
C136, 142, 147	4822 069 01034	4,7 $\mu$ F	35	Tantalum
C153	4822 069 01034	4,7 $\mu$ F	35	Tantalum
C117, 122, 127	4822 069 00562	4700 pF	350	Feed through
C132, 137, 143	4822 069 00562	4700 pF	350	Feed through
C148, 154, 166	4822 069 00562	4700 pF	350	Feed through
C167, 168, 169	4822 069 00562	4700 pF	350	Feed through
C171, 172, 173	4822 069 00562	4700 pF	350	Feed through
C174	4822 069 00562	4700 pF	350	Feed through
C134, 146	4822 121 40099	0.33 $\mu$ F	60	
C157	905/D1K6	1600 pF	500	Mica
C161	C 420 ZZ/04	25 $\mu$ F	4	Tantalum
C162	909/W2.5	2.5 $\mu$ F	16	Tantalum
C164	4822 069 00884	100 $\mu$ F	4	Electrolytic
C302	4822 121 50219	0.01 $\mu$ F	125	Polyester
C303, 304, 306	909/C12.5	12.5 $\mu$ F	25	Electrolytic
C316	909/C12.5	12.5 $\mu$ F	25	Electrolytic
C305	4822 121 40088	0.01 $\mu$ F	250	Polyester
C307, 311	4822 069 00682	0.47 $\mu$ F	250	Polyester
C308, 309	4822 069 01105	0.1 $\mu$ F	250	Plate
C313	4822 121 40098	0.39 $\mu$ F	250	Polyester
C314	4822 069 01065	0.039 $\mu$ F	250	Polyester
C316	909/C12.5	12.5 $\mu$ F	25	Electrolytic
C317	4822 069 01123	0.22 $\mu$ F	250	Polyester
C318	909/X250	250 $\mu$ F	40	Electrolytic
C401, 403, 407	4822 069 00562	4700 pF	350	Feed through
C409, 412, 418	4822 069 00562	4700 pF	350	Feed through
C421, 424	4822 069 00562	4700 pF	350	Feed through
C402, 404, 406	4822 069 01103	0.068 $\mu$ F	250	Plate

<i>Number</i>	<i>Code number</i>	<i>Value</i>	<i>Volts</i>	<i>Discription</i>
C410, 413, 419	4822 069 01103	0.068 $\mu$ F	250	Plate
C422, 423	4822 069 01103	0.068 $\mu$ F	250	Plate
C414, 417	4822 069 00945	1000 pF	30	Plate (cer)
C416	4822 069 01139	20 pF		Trimmer

### COILS, RELAYS, BEADS

<i>Number</i>	<i>Code number</i>	<i>Qty.</i>	<i>Discription</i>
L101	4822 158 10131	1	Coil
L102, 103, 104	4822 207 00365	9	Bead
L106, 107, 108			
L109, 111, 112			
L301	4822 158 40033	1	Demodulator coil
L302	4822 158 30102	1	Oscillator coil
RE101	SZC7123	1	Relay
RE301	4822 280 10025	1	Relay

### SEMI-CONDUCTORS

#### Diodes

GR101	OA200
GR102	OA200
GR103	BAY33
GR104	BAY38
GR106	BAY38
GR403	BAY38
GR404	AAZ13
GR406	AAZ13
GR407	BAY38

#### Zener diodes

GR107	BZY60
GR109	BZY60
GR111	BZY62
GR112	BZY63
GR113	BZY60
GR114	BZY63
GR301	BZY63
GR302	BZY63

#### Transistors

TS101	BF109	TS119	BC107	TS403	BC107
TS102	2N3563	TS121	BC107	TS404	2N3563
TS103	2N3563	TS301	2N930	TS406	2N3563
TS104	2N3563	TS302	BCY32	TS407	2N3563
TS106	2N3563	TS303	BCY32	TS408	ASZ21
TS107	2N3563	TS304	BC107	TS409	ASZ21
TS108	2N3563	TS306	BC107	TS411	2N3563
TS109	2N3563	TS307	ASY75		
TS111	2N930	TS308	ASY75		
TS112	2N930	TS309	ASY75		
TS113	2N930	TS311	ASY75		
TS114	2N930	TS312	BCY39		
TS116	BC107	TS313	BCY39		
TS117	BC107	TS401	BF173		
TS118	BC107	TS402	2N3563		

### VALVE

B 101            EC 1000

The semi-conductors and the valves are furnished by Com. Dept. ELCOMA.

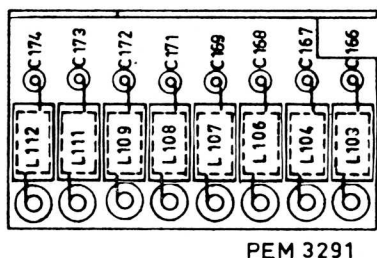

PEM 3291

Fig. 17. Printed circuit U 7 (Supply filter)

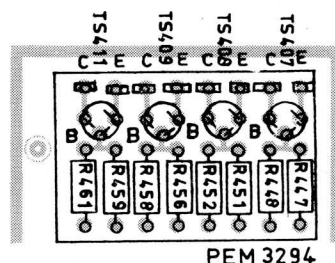

PEM 3294

Fig. 18. Printed circuit U 8 (Final stage)

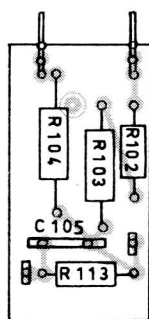

PEM 3292

Fig. 19. Printed circuit U 9 (Grid circuit)

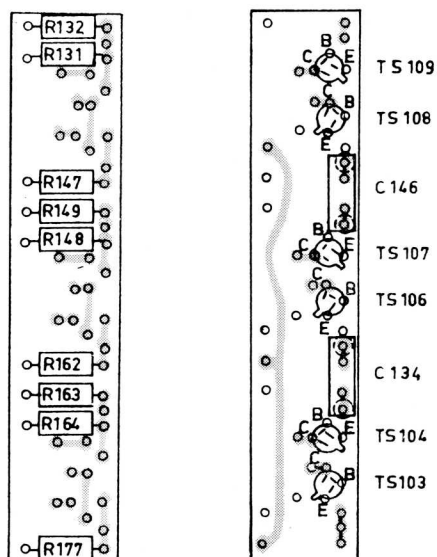

PEM 3293

Fig. 20. Printed circuit U 10 (H.F. amplifier)

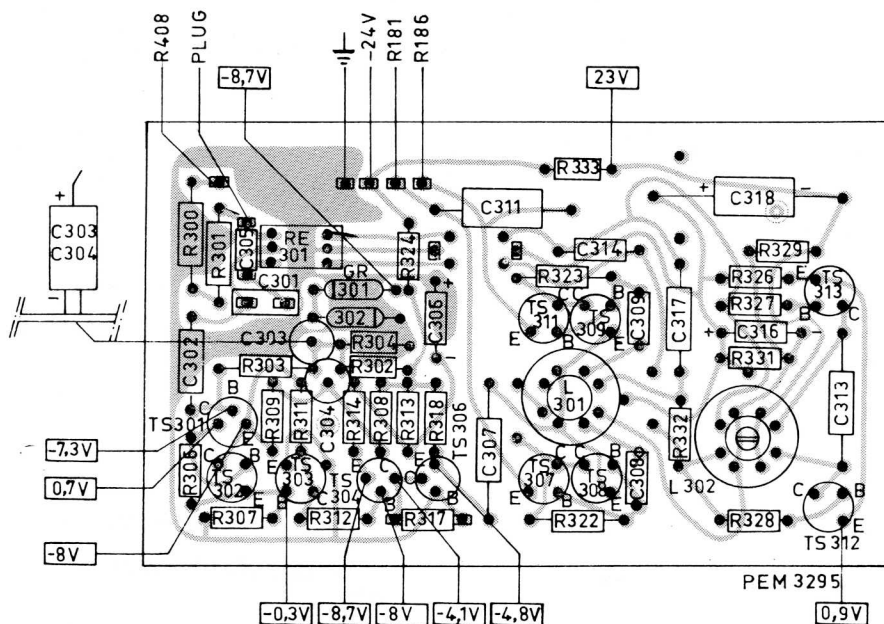

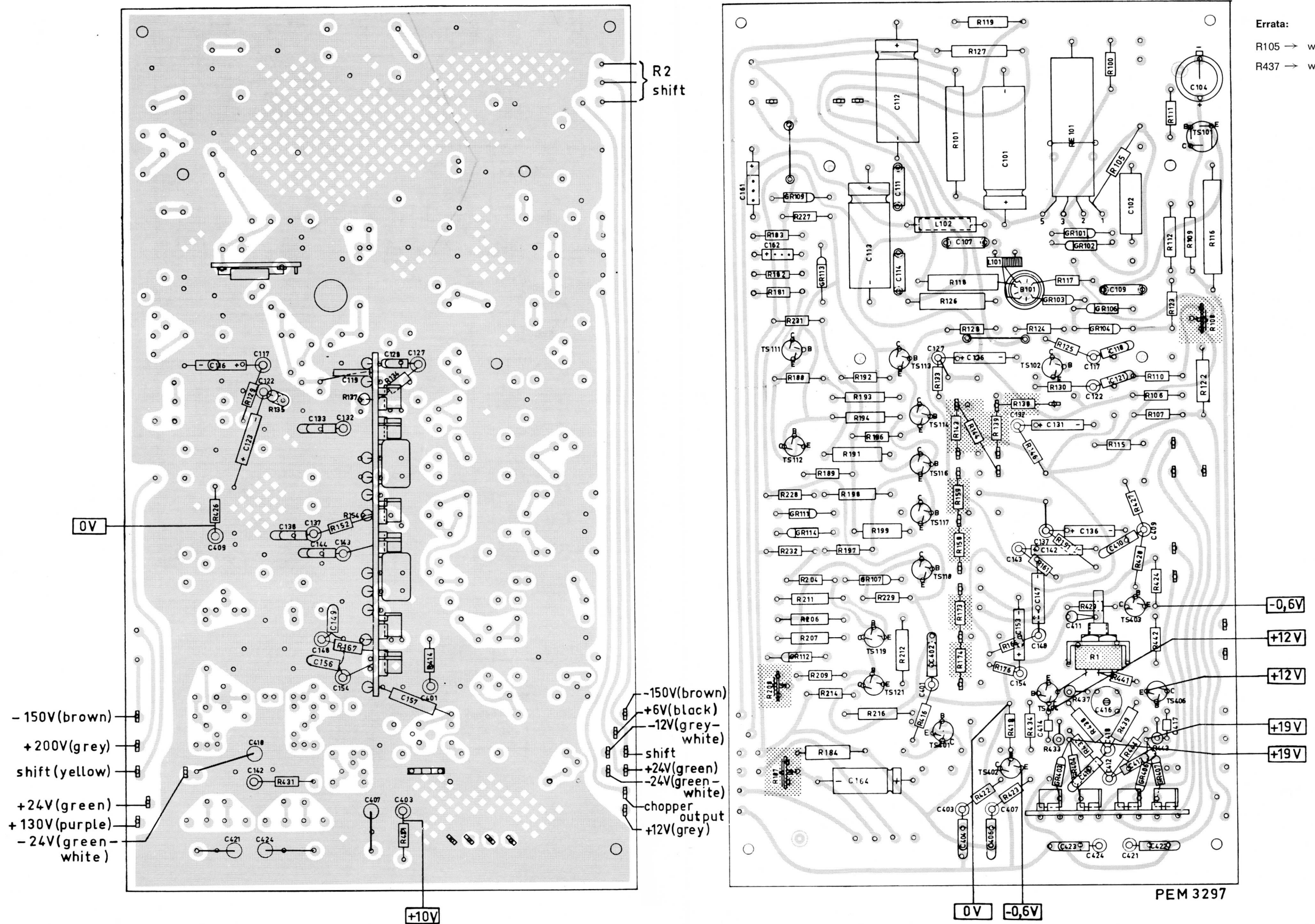

Errata:  
 R105 → wire  
 R437 → wire

Fig. 21. Printed circuit U 11 (Amplifier)

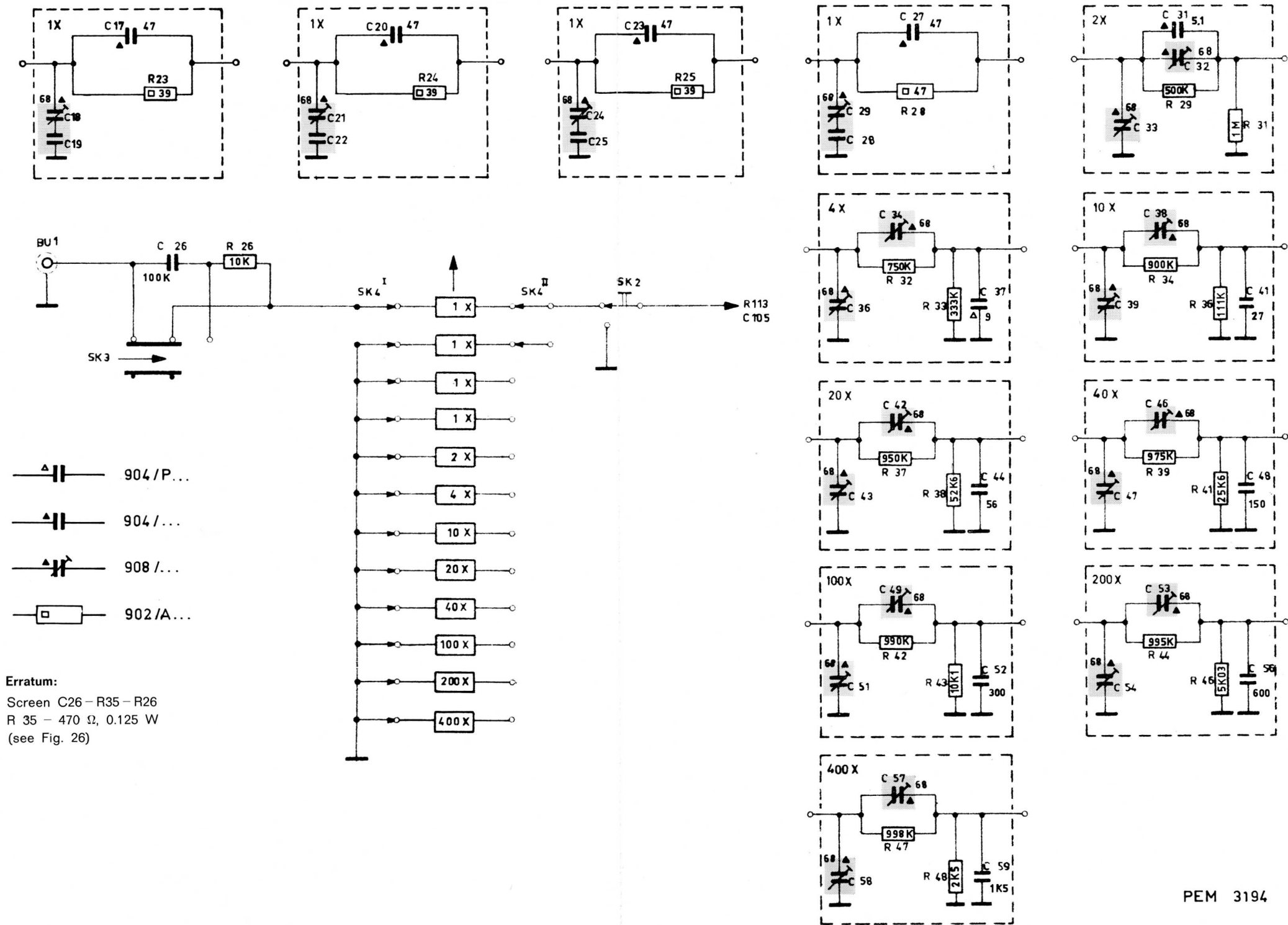
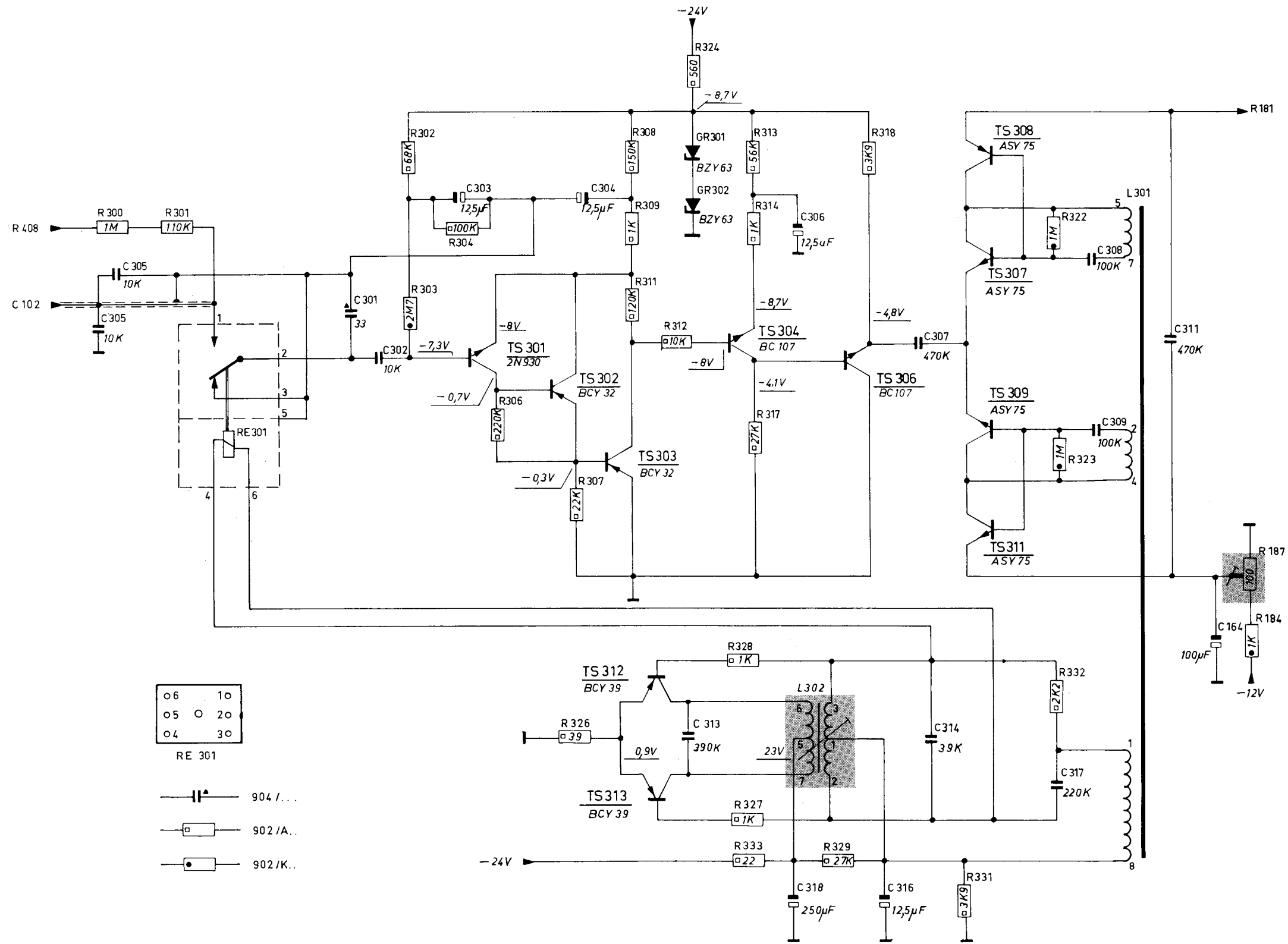

Fig. 23. Attenuator circuit





PEM 3198

Fig. 24. Chopper amplifier circuit



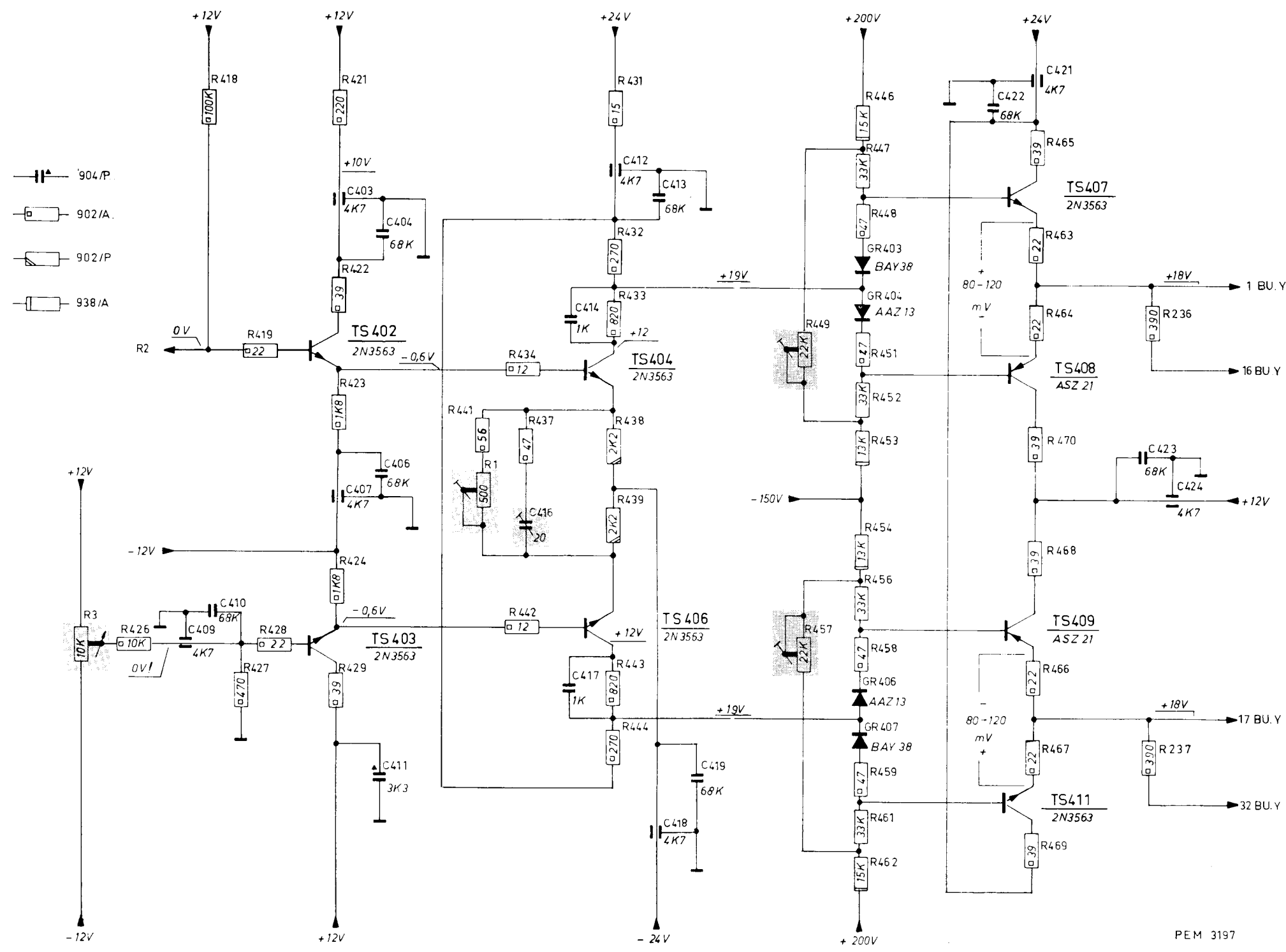

- Errata:**
- R419 → 100 Ω
  - R434 → 100 Ω
  - R437 → 0 Ω
  - R442 → 100 Ω
  - R448 → 56 Ω
  - R451 → 56 Ω
  - R458 → 56 Ω
  - R459 → 56 Ω
  - TS403 → BC107

Fig. 25. Final amplifier circuit

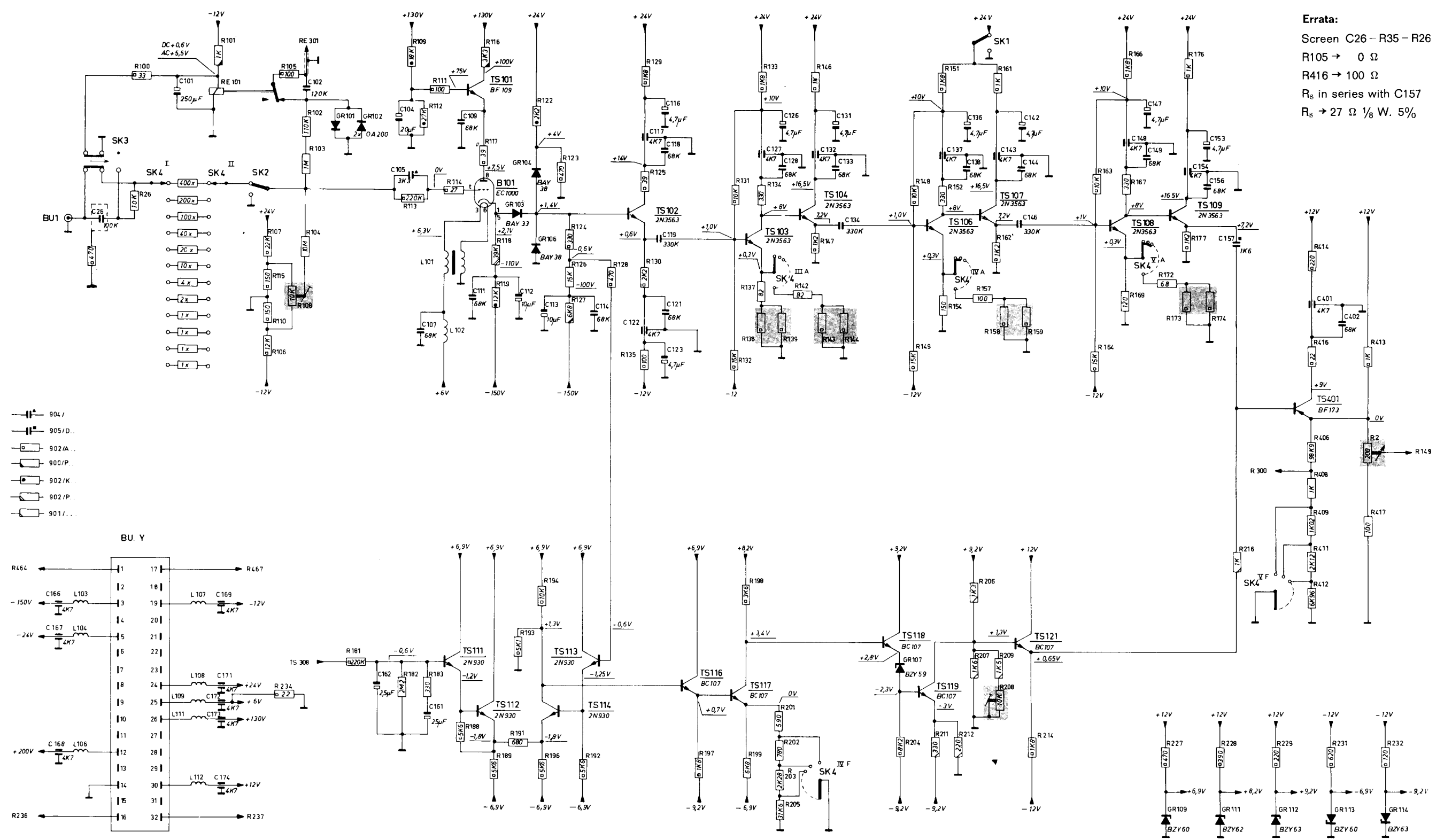

**Errata:**  
 Screen C26 - R35 - R26  
 R105 → 0 Ω  
 R416 → 100 Ω  
 R<sub>s</sub> in series with C157  
 R<sub>s</sub> → 27 Ω 1/8 W. 5%

Fig. 26. HF and LF amplifier circuit



15-11-1967	PM 3332/01 9444 033 32011	Cd 542
------------	------------------------------	--------

**Information  
PIT-EMA**

As of serial number D651 some modifications have been introduced, amongst others, to improve the squarewave reproduction and to prevent oscillations. However, these modifications do not affect the adjusting procedure and the technical data. Up-to-date circuit diagrams are attached. The principal changes are:

Attenuator circuit (Fig. 23)

Between input socket BU1 and blocking capacitor C26: resistor R27 (12  $\Omega$ , 1/8 W, 5 %).  
The screening of C26 is connected to junction C26-R26 via resistor R35 (470  $\Omega$ , 1/8 W, 5 %).

Chopper amplifier circuit (Fig. 24)

Transistor TS313 and resistor R326 are bridged by a ceramic capacitor C312 (1000 pF, 500 V). On account of this and in view of a more favourable arrangement of parts, printed circuit board U12 (Fig. 22) is changed. The anode voltage of GR301 amounts to -18.7 V instead of -8.7 V.

Final amplifier circuit (Fig. 25)

To improve the HF squarewave reproduction, a series RC circuit consisting of R445 (approx. 22 k $\Omega$ , 1/8 W, 5 %) and C415 (ceramic, approx. 33 pF, 500 V) is connected between junctions R432-R433 and R443-R444.

The following parts have been added to improve the control range of R1, C416 and R3:  
control range R1: resistor R425 (100  $\Omega$ , 1/8 W, 5%) between junctions R441-R437 and R1-C416,  
control range C416: ceramic capacitor C420 (39 pF, 500 V) in parallel with C416.

Note: R437 is maintained.

control range R3: resistor R430 (33 k $\Omega$ , 1/8 W, 5 %) between -12 V and junction R427-R428.

The value of the voltage between the emitters of TS407 and TS408 and between the emitters of TS409 and TS411 is approx. 80 mV instead of 80...120 mV.

Moreover, some resistor values have been changed.

HF and LF amplifier circuit (Fig. 26)

To improve the HF squarewave reproduction, a series RC circuit consisting of R140 (approx. 1 k $\Omega$ , 1/8 W, 5 %) and C129 (560 pF, 500 V) has been added in parallel with R139 in the HF amplifier.

To improve the LF squarewave reproduction, three series RC circuits have been added to the LF amplifier, viz.

1. R190 (100  $\Omega$ , 1/8 W, 5 %) and C163 (feed-through capacitor, 68 pF, 350 V) between junction: R191-R196 and earth,
2. R210 (12 k $\Omega$ , 1/8 W, 5 %) and C160 (plate capacitor, 68,000 pF, 250 V) in parallel with R211,
3. R213 (approx. 22 k $\Omega$ , 1/8 W, 5 %) and C165 (feed-through capacitor, 1500 pF, 350 V) between junction R211-emitter TS119 and earth.

To prevent oscillations, a resistor (R407, 56  $\Omega$ , 1/8 W, 5 %) is included in the base circuit of TS401.

In the cross-over filter, resistor R215 (approx. 12  $\Omega$ , 1/8 W, 5 %) is connected between C157 and junction R407-R216.

Diode GR108 (OA202) is connected between the master contact of SK1 and earth (its anode at the earth side). Resistor R238 (6,800  $\Omega$ , 1 W, 5 %) is connected between coils L106 and L111 at the supply side of printed circuit board U7.

Some resistor values have also been changed.

The following voltages are now different:

collector of TS117 becomes +4.1 V instead of +3.4 V,

emitter of TS118 becomes +3.5 V instead of +2.8 V,

base of TS119 becomes -2.4 V instead of -2.3 V,

anode of B101 becomes +74 V instead of +7.5 V,

supply for R413 becomes -12 V instead of +12 V.

Ab Seriennummer D651 sind einige Änderungen eingeführt, u. a. um die Rechteckwiedergabe zu verbessern und um Schwingen zu verhindern.

Diese Änderungen beeinflussen jedoch das Abgleichverfahren und die technische Beschreibung nicht. Angepasste Schaltbilder sind beigelegt.

Die wichtigsten Änderungen sind:

#### Abschwächerschaltung (Abb. 23)

Zwischen Eingangsbuchse BU1 und Sperrkondensator C26: Widerstand R27 (12 Ohm; 1/8 W; 50 %).

Abschirmung C26 ist mit Widerstand R35 (470 Ohm; 1/8 W; 5 %) mit Knotenpunkt C26-R26 verbunden.

#### Zerhacker-Verstärkerschaltung (Abb. 24)

Transistor TS313 und Widerstand R326 sind durch einen Keramikkondensator C312 (1000 pF; 500 V) überbrückt.

Im Zusammenhang hiermit und mit einer günstigeren Anordnung von Einzelteilen ist Printplatte U12 (Abb. 22) geändert worden.

Die Anodenspannung von GR301 beträgt -18,7 V statt -8,7 V.

#### Ausgangsverstärkerschaltung (Abb. 25)

Zur Verbesserung der HF-Rechteckwiedergabe wurde eine Serie-RC-Schaltung zwischen den Knotenpunkten R432-R433 und R443-R444 hinzugefügt, und zwar R445 (zirka 22 kOhm; 1/8 W; 5 %) und C415 (keramisch zirka 33 pF; 500 V).

Zur Verbesserung der Regelbereiche von R1, C416 und R3 wurden folgende Einzelteile hinzugefügt:

Regelbereich R1: Widerstand R425 (100 Ohm; 1/8 W; 5 %) zwischen Knotenpunkten R441-R437 und R1-C416.

Regelbereich C416: Keramikkondensator C420 (39 pF; 500 V) parallel zu C416.

Anmerkung: R437 wurde trotzdem beibehalten.

Regelbereich R3: Widerstand R430 (33 kOhm; 1/8 W; 5 %) zwischen -12 V und Knotenpunkt R427-R428.

Der Spannungswert zwischen den Emittern TS407 und TS408 sowie zwischen TS409 und TS411 ist zirka 80 mV statt 80 ÷ 120 mV.

Einige Widerstandswerte wurden geändert.

#### HF- und NF-Verstärkerschaltung (Abb. 26)

Zur Verbesserung der HF-Rechteckwiedergabe wurde im HF-Verstärker eine Serien-RC-Schaltung hinzugefügt, nämlich R140 (zirka 1 kOhm; 1/8 W; 5 %) und C129 (560 pF; 500 V) parallel zu R139.

Zur Verbesserung der NF-Rechteckwiedergabe wurden drei Serien-RC-Schaltungen im NF-Verstärker hinzugefügt, nämlich:

1. R190 (100 Ohm; 1/8 W; 5 %) und C163 Durchführungskondensator (68 pF; 350 V) zwischen Knotenpunkt R191-R196 und Erde.
2. R210 (12 kOhm; 1/8 W; 5 %) und C160 Plattenkondensator (68000 pF; 250 V) parallel zu R211.
3. R213 (zirka 22 kOhm; 1/8 W; 5 %) und C165 Durchführungskondensator (1500 pF; 350 V) zwischen Knotenpunkt R211 - Emitter TS119 und Erde.

Zur Vermeidung von Schwingungen wurde in der Basisschaltung von TS401 ein Widerstand angeordnet, nämlich R407 (56 Ohm; 1/8 W; 5 %).

Im Überschneidungsfilter wurde Widerstand R215 (zirka 12 Ohm; 1/8 W; 5 %) zwischen C157 und Knotenpunkt R407 -R216 angeordnet.

Diode GR108 (OA202) wurde zwischen dem Mutterkontakt von SK1 und Erde angebracht, die Anode befindet sich an der Erdseite. Widerstand R238 (6800 Ohm; 1 W; 5 %) wurde zwischen den Spulen L106 und L111 auf Printplatte U7 an der Speiseseite angebracht.

Einige Widerstandswerte wurden geändert. Folgende Spannungen weichen ab:

Kollektor TS117 wird +4,1 V statt +3,4 V,

Emitter TS118 wird +3,5 V statt +2,8 V,

Basis TS119 wird -2,4 V statt -2,3 V,

Anode B101 wird +74 V statt +7,5 V,

Speisung von R413 wird -12 V statt +12 V.

Quelques modifications ont été introduites à partir du numéro de série D651 notamment pour améliorer la reproduction rectangulaire et pour éviter l'oscillation. Ces modifications n'ont pas d'influence sur les réglages ni sur la description technique. Les schémas mis à jours sont joints.

Les principales modifications sont les suivantes:

#### Circuit atténuateur (fig. 23)

Entre douille d'entrée BU1 et condensateur de blocage C26: résistance R27 (12  $\Omega$ ; 1/8 W; 5 %). Le blindage de C26 est relié avec la résistance R35 (470  $\Omega$ ; 1/8 W; 5 %) au noeud C26-R26.

#### Circuit amplificateur découpeur (fig. 24)

Le transistor TS313 et la résistance R326 sont pontées par un condensateur céramique C312 (1000 pF; 500 V). La carte imprimée U12 (fig. 22) a été modifiée par conséquent et aussi en vue d'une disposition plus favorable des pièces.

La tension anode de GR301 amonte -18,7 V au lieu de -8,7 V.

#### Circuit amplificateur de sortie (fig. 25)

Le circuit RC série constitué de R445 (env. 22 k $\Omega$ ; 1/8 W; 5 %) et de C415 (céramique env. 33 pF; 500 V) est inséré entre les noeuds R432-R433 et R443-R444 afin d'améliorer la reproduction rectangulaire HF.

Les pièces suivantes ont été ajoutées en vue d'améliorer les gammes de réglage de R1, C416 et R3:

gamme de réglage R1: résistance R425 (100  $\Omega$ ; 1/8 W; 5 %) entre les noeuds R441-R437 et R1-C416;

gamme de réglage C416: condensateur céramique C420 (39 pF; 500 V) parallèle à C416.

Observation: R437 a été maintenue quand même.

gamme de réglage R3: résistance R430 (33 k $\Omega$ ; 1/8 W; 5 %) entre -12 V et noeud R427-R428. Valeur de tension entre les émetteurs TS407 et TS408 ainsi que TS409 et TS411: env. 80 mV au lieu de 80 à 120 mV.

Quelques valeurs de résistance ont été modifiées.

#### Circuit amplificateur HF et BF (fig. 26)

Pour améliorer la reproduction rectangulaire HF il a été ajouté un circuit RC dans l'amplificateur HF, à savoir R140 (env. 1 k $\Omega$ ; 1/8 W; 5 %) et C129 (560 pF; 500 V) parallèle à R139.

3 Circuits RC série ont été insérés dans l'amplificateur BF, afin d'améliorer la reproduction rectangulaire BF, à savoir:

1. R190 (100  $\Omega$ ; 1/8 W; 5 %) et condensateur de passage C163 (68 pF; 350 V) entre le noeud R191-R196 et la terre.
2. R210 (12 k $\Omega$ ; 1/8 W; 5 %) et condensateur plaque C160 (68000 pF, 250 V) parallèle à R211.
3. R213 (env. 22 k $\Omega$ ; 1/8 W; 5 %) et condensateur de passage C165 (1500 pF; 350 V) entre le noeud R211 - émetteur TS119 et la terre.

Une résistance, R407 (56  $\Omega$ ; 1/8 W; 5 %) a été insérée dans le circuit de base de TS401 en vue d'éviter des oscillations.

La résistance R215 (env. 12  $\Omega$ ; 1/8 W; 5 %) a été insérée dans le filtre cross-over entre C157 et le noeud R407-R216.

La diode GR108 (OA202) a été insérée entre le contact mère de SK1 et la terre; l'anode est reliée du côté terre.

La résistance R238 (6800  $\Omega$ ; 1 W; 5%) a été insérée entre les bobines L106 et L111 sur la carte imprimée U7 du côté alimentation.

Quelques valeurs de résistance ont été modifiées.

Les tensions suivantes ont été modifiées:

collecteur TS117: +4,1 V au lieu de +3,4 V,

émetteur TS118: +3,5 V au lieu de +2,8 V,

base TS119: -2,4 V au lieu de -2,3 V,

anode B101: +7,4 V au lieu de +7,5 V,

alimentation de R413: -12 V au lieu de +12 V.





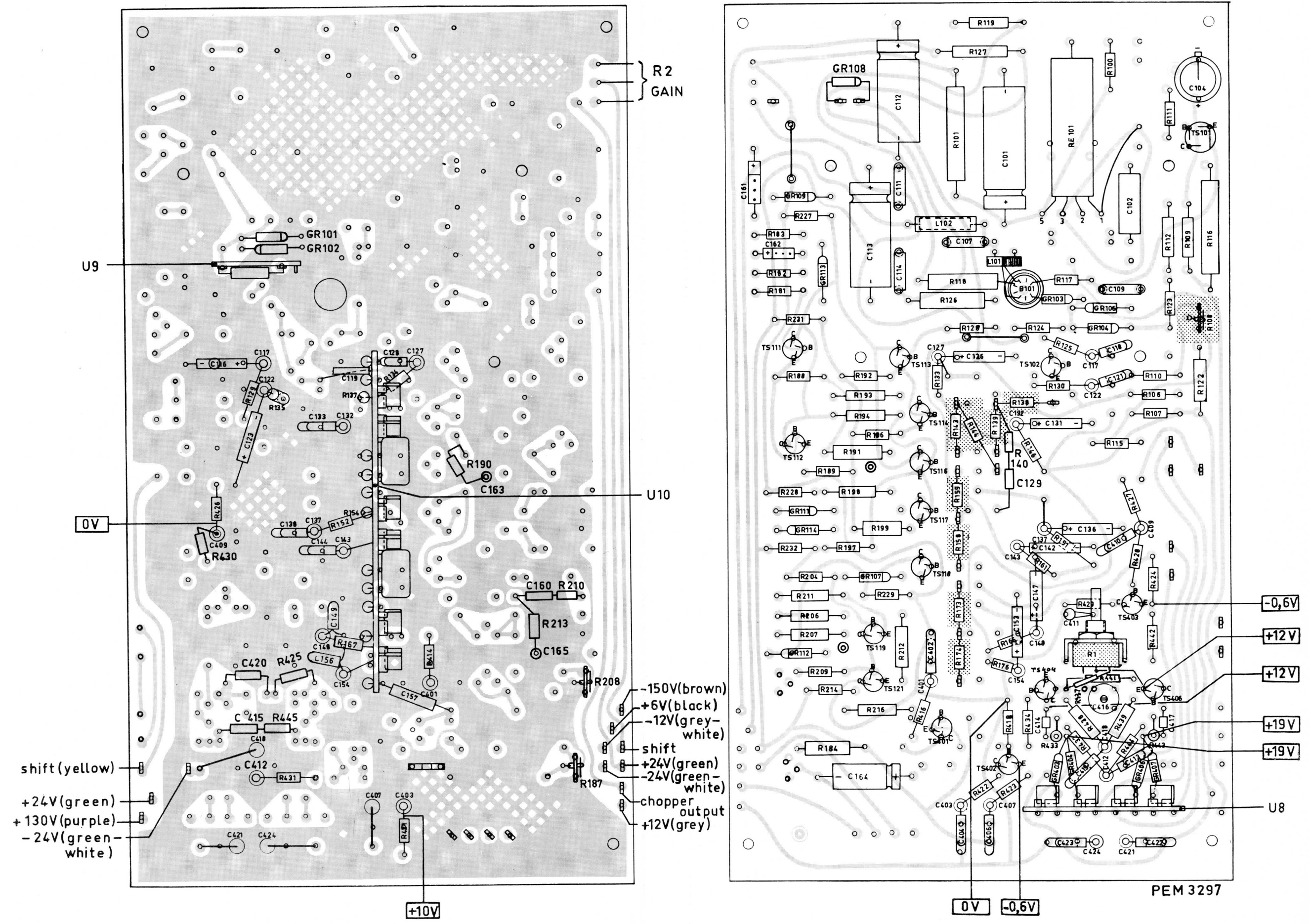
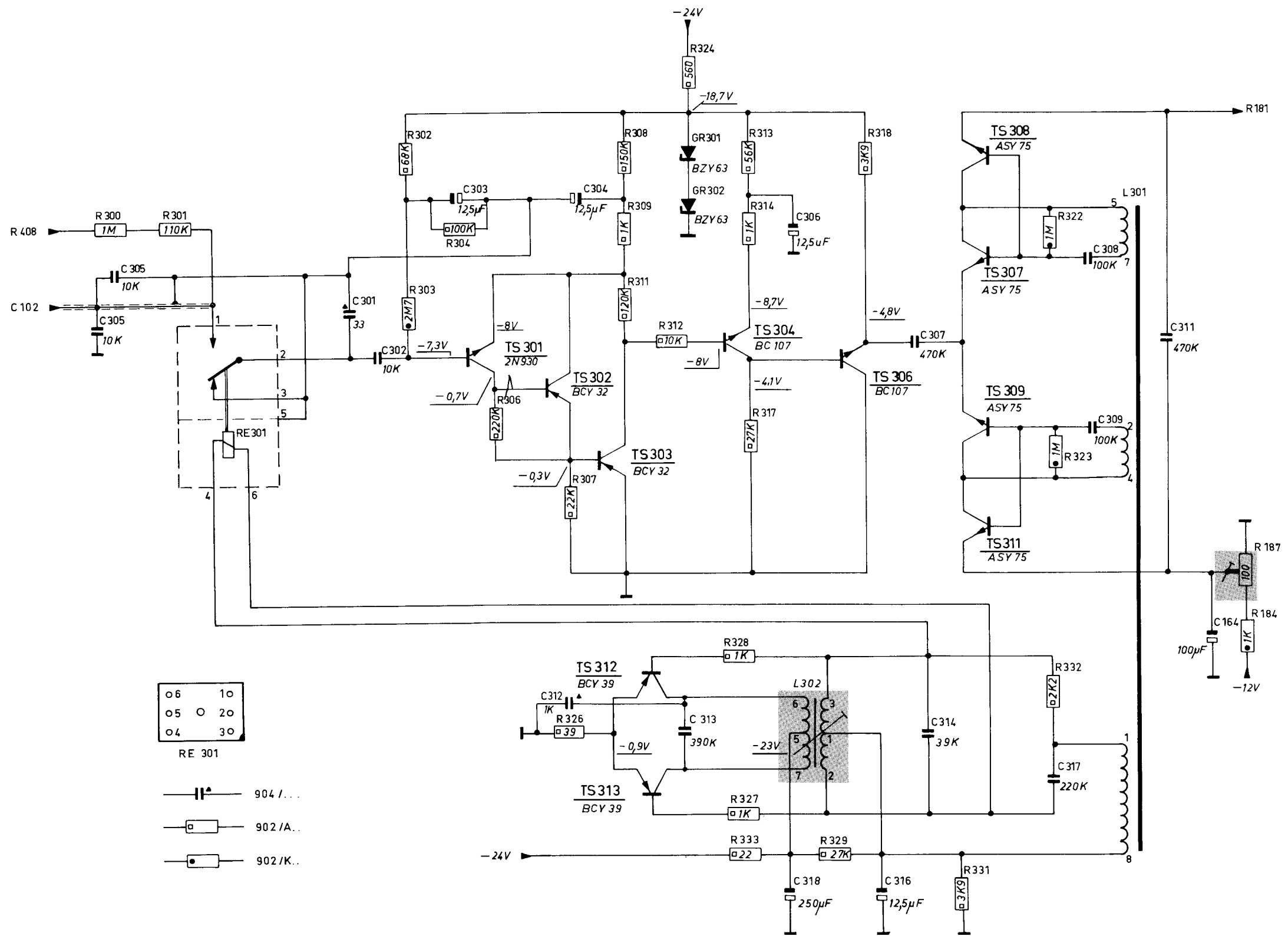
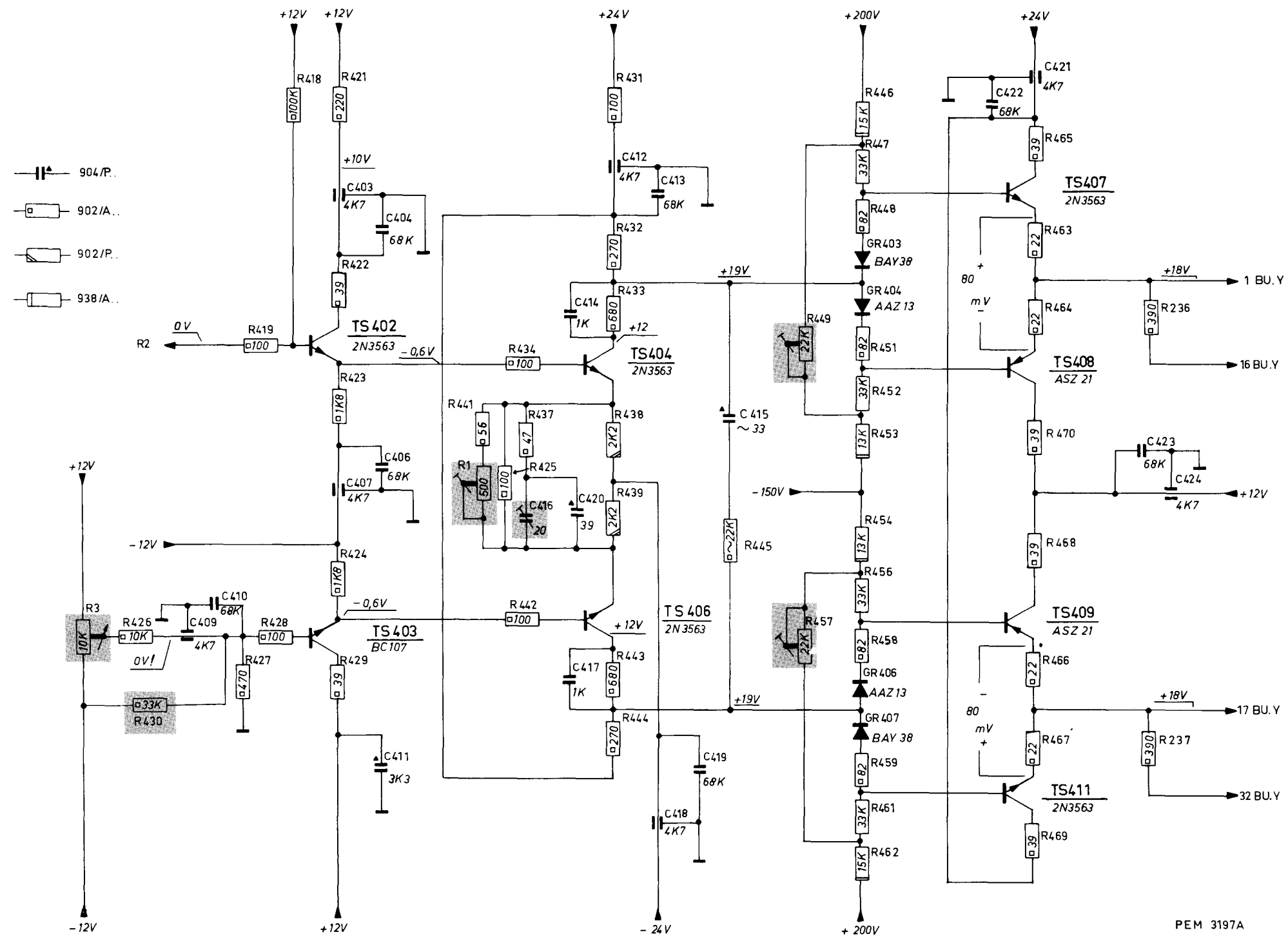

Fig. 21. Printed circuit U 11 (Amplifier)



PEM 3198A

Fig. 24. Chopper amplifier circuit



PEM 3197A

Fig. 25. Final amplifier circuit



# PHILIPS

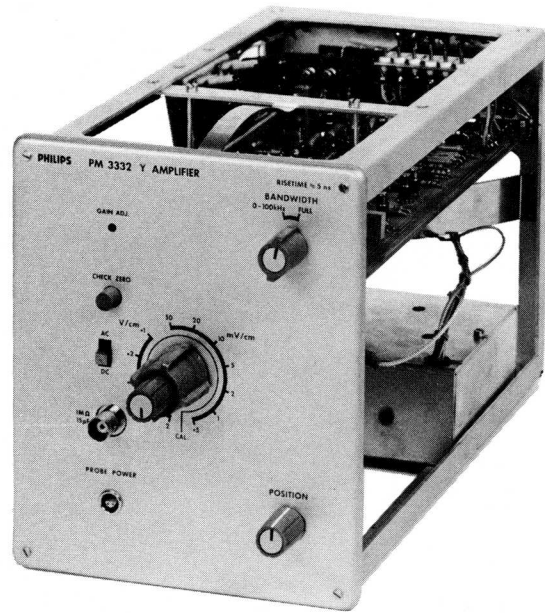

## **PM 3332** **LOW DRIFT HIGH SENSITIVITY WIDE BAND AMPLIFIER**

**IMPORTANT**

*In correspondence concerning this apparatus, please quote the type number and the serial number as given on the type plate at the rear of the apparatus.*

# Contents

<b>GENERAL INFORMATION</b>	5	C. D.C. amplifier	13
I. Introduction	5	D. Interstage network	13
II. Technical data	5	E. Chopper amplifier	15
III. Description of the block diagram	6	1. Chopper input	15
<b>DIRECTIONS FOR USE</b>	7	2. Operational amplifier	15
IV. Installation	7	3. Top detector	15
V. Function of the controls	7	4. Chopper driver	15
A. Input	7	F. Final amplifier	16
B. Deflection coefficient	8	<b>X. Checking and adjusting</b>	17
C. Bandwidth	8	A. General information	17
D. Position	8	B. Chopper amplifier	17
E. Gain adjustment	8	C. Gate current compensation	18
F. Probe power outlet	8	D. Balance adjustment	18
VI. Applications	9	E. Deflection coefficient	19
<b>SERVICE DATA</b>	11	F. Square wave response	19
VII. Introduction	11	G. Frequency response curve	19
VIII. Principles of the control loop	12	H. Deflection and shift	19
IX. Circuit description	13	I. AC-DC switch: check zero	19
A. Input circuit	13	J. Input attenuator	20
B. H.F. amplifier	13	1. Attenuation and square wave response	20
		2. Input capacitance	20
		K. Triggering	20
		L. Probe power	20
		<b>XI. List of service parts</b>	21
		A. Mechanical parts	21
		B. Electrical parts	21

## List of Figures

1	Schematic diagram of the controls	7	15	Right hand side of amplifier	17
2	Input terminal and controls	7	16	Left hand side of amplifier	18
3	Deflection coefficient switch	8	17	Input RC standardizer	20
4	Bandwidth selector	8	18	Probe power outlet	20
5	Position control	8	19	Printed circuit Unit 7 (Supply filter)	27
6	Gain adjustment control	8	20	Printed circuit Unit 8 (Final stage)	27
7	Probe power outlet	8	21	Printed circuit Unit 9 (Gate circuit)	27
8	Voltage measurement	9	22	Printed circuit Unit 10 (H.F. amplifier)	27
9	Limits of Y-deflection	9	23	Printed circuit Unit 12 (Chopper amplifier)	27
10	Control loop	12	24	Printed circuit Unit 11 (Amplifier)	30
11	Bandwidth characteristics	14	25	Attenuator circuit	31
12	Operation of the crossover filter	14	26	Chopper amplifier circuit	34
13	Chopper amplifier circuit waveforms	15	27	Final amplifier circuit	38
14	Operation of the demodulator	15	28	H.F. and L.F. amplifier circuit	42



# General Information

## I. INTRODUCTION

The h.f. amplifier PM 3332 is a plug-in unit which is used as a vertical amplifier of the basic oscilloscopes PM 3330 and PM 3370.

The PM 3332 covers a wide range of applications, due to its high sensitivity and large bandwidth.

The amplifier is chopper-stabilized, so that d.c. drift is eliminated. The underlying manual is valid for PM 3332/04 and following versions.

They differ from older versions in that an improved input circuit and chopper amplifier is used.

## II. TECHNICAL DATA

Properties expressed in numerical values with a statement of tolerance are guaranteed by the factory. Numerical values without tolerances are intended for information purposes and only indicate the properties of an average instrument. The numerical values hold good for nominal mains voltage unless otherwise stated.

### Input circuit

input	asymmetrical
coupling	a.c. or d.c.
input socket	B.N.C.
input impedance	1 M $\Omega$ // 15 pF
maximum permissible d.c. voltage in position AC	400 V

### Amplifier

zero level	the zero level may be checked by means of the CHECK ZERO button.
deflection coefficient	adjustable to the following twelve calibrated values: 0.5 mV/cm, 1 mV/cm, 2 mV/cm, 5 mV/cm, 10 mV/cm, 20 mV/cm, 50 mV/cm, 100 mV/cm, 200 mV/cm, 500 mV/cm, 1 V/cm, 2 V/cm. Tolerance 3 %, a continuous attenuation of 1:2.5 is possible (non calibrated).

### Bandwidth

d.c.	0 to 50 MHz (FULL) or 0 to 100 kHz
a.c.	1.6 Hz to 50 MHz (FULL) or 1.6 Hz to 100 kHz.

### Noise at position of maximum sensitivity

#### 0 to 50 MHz bandwidth

open circuit input	4 mm
short circuit input	3 mm

#### 0 to 100 kHz

open circuit input	1.5 mm
short circuit input	0.4 mm

### Rise time at maximum bandwidth

7 ns

### Rise time of amplifier only

5 ns

### Overshoot

< 2 %

Pulse droop	< 3 %
Magnification	Up to 10 times of the useful screen height, disposed symmetrically about the centre-line of the screen. The peaks of a display which has been magnified up to 3 times of the useful screen height, can be brought to within the limits of the screen by means of the POSITION control.
Drift	500 $\mu$ V/Week
Triggering of the main time base required display height	3 mm for frequencies up to 10 MHz 10 mm for frequencies up to 30 MHz 20 mm for frequencies up to 50 MHz 2 cm video signal in the TV LINE and TV FRAME positions. 1 cm in position "AUT"
Mechanical data	
Width	15 cm
Depth (including knobs and plug)	27.5 cm
Height	17.5 cm
Weight	2 kg
Optional accessories	measuring probe PM 9350 (input impedance 10 M $\Omega$ // 10 pF, attenuation 1:10, tolerance $\pm$ 2 % maximum permissible voltage 500 V peak – For further details refer to the probe manual).

## Description of the block diagram



The input circuit includes an AC-DC switch, a mV/cm - V/cm step attenuator, and a CHECK ZERO push button switch.

The step attenuator is parallel-connected to an a.c. coupled h.f. amplifier and a d.c. coupled l.f. amplifier. The output voltages from these two amplifiers are connected, via a cross-over filter, to an output amplifier. A sample of the crossover filter output voltage is taken via an attenuator and is compared with the input of the source follower stage. The resultant difference voltage,

due to the drift of the d.c. coupled l.f. amplifier, is converted into a square wave signal by the MOST chopper. This square wave voltage is amplified before being applied to a detector. The detector output is passed to the d.c. coupled l.f. amplifier so that it acts as heavy drift voltage feedback.

The output amplifier incorporates continuous gain, the POSITION control, and a preset gain adjustment facility. Signals from the output amplifier are applied via the Y-plug, to the vertical amplifier and trigger preamplifier of the main frame.

# Directions For Use

## Installation

IV

The PM 3332 should be slid into the left hand compartment (Y-unit) of the basic oscilloscope PM 3330 or PM 3370.

Supply switching is by means of the mains switch on the basic oscilloscope.

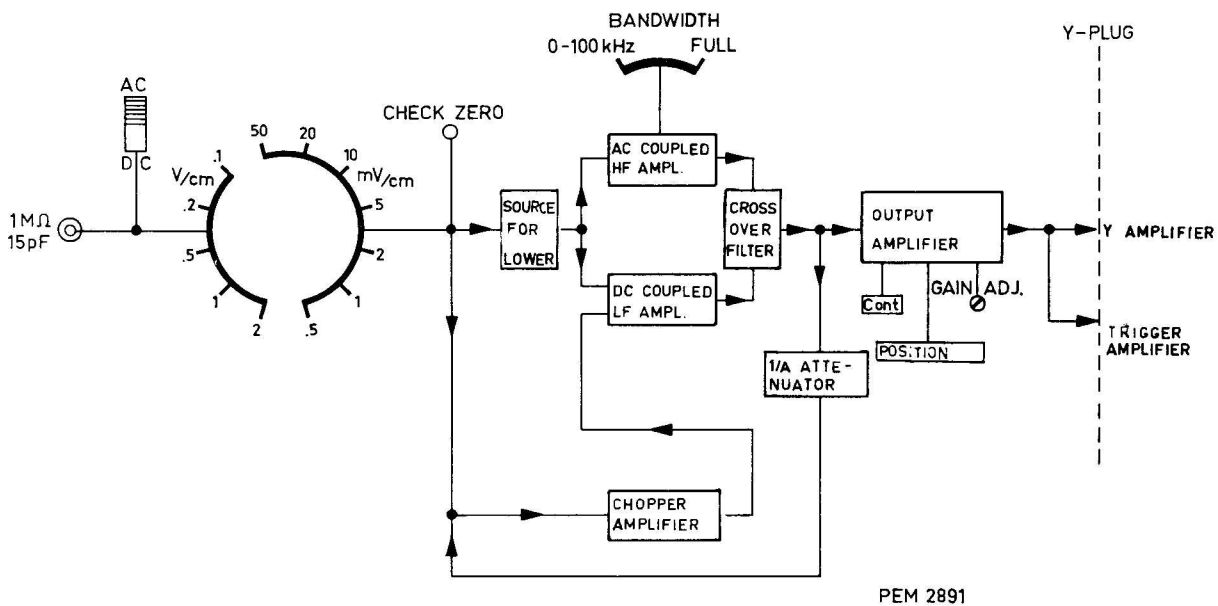

Fig. 1. Schematic diagram of the controls

## Functions of the controls

V

### A. INPUT

The  $1\text{ M}\Omega/15\text{ pF}$  input socket BU1 is connected to the step attenuator via the AC-DC switch SK3. With switch SK3 in the AC position, the input is a.c. coupled to the attenuator. Direct coupling is obtained when the switch is set to DC.

The connection between the step attenuator and the amplifier is cut off, and the amplifier input terminal is earthed, when the push-button CHECK ZERO switch SK2 is depressed. This enables the zero level of the amplifier to be checked.

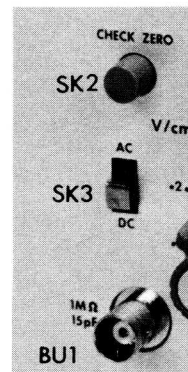

Fig. 2. Input terminal and controls

## B. DEFLECTION COEFFICIENT

The deflection coefficients are selected by means of the attenuator switch SK4. These mV/cm or V/cm deflection coefficients are calibrated provided that the continuous gain control R2 is set to its CAL (fully clockwise) position.

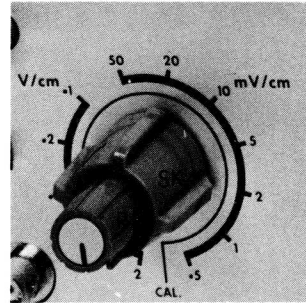

Fig. 3. Deflection coefficient switch

## C. BANDWIDTH

Maximum bandwidth is obtained by setting the BANDWIDTH switch SK1 to its FULL position. A noise band having a width of a few millimeters, will appear on the screen when the attenuator switch is set to the most sensitive position.

With the BANDWIDTH switch SK1 at the 0-100 kHz position, the bandwidth is limited to the indicated value, at which the noise can be neglected.

**Note:** During maximum bandwidth operation, the noise level may be minimized by using the attenuator to reduce the amplifier sensitivity.

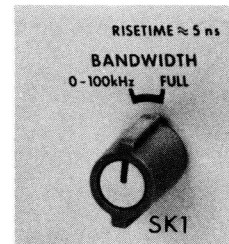

Fig. 4. Bandwidth selector

## D. POSITION

The display may be shifted vertically by turning the POSITION control R3.

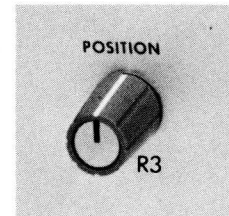

Fig. 5. Position control

## E. GAIN ADJUSTMENT

The calibration voltage taken from the basic oscilloscope may be used to check the deflection coefficients of the PM 3332 wide band amplifier. In the event of a deflection coefficient error, the necessary correction may be applied by means of the preset GAIN ADJ. potentiometer R1. Note that the continuous gain control R2 must be turned to its CAL position prior to any adjustment of R1.

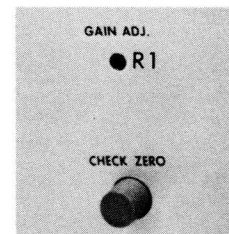

Fig. 6. Gain adjustment control

## F. PROBE POWER

This outlet, BU2, provides the 24 V positive and negative voltage necessary for active probes.

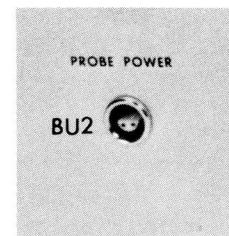

Fig. 7. Probe power outlet

# Applications



To measure the voltage of a signal, use the controls of both the amplifier and basic oscilloscope to obtain a triggered display. The calibrated deflection coefficient can then be used to calculate the voltage amplitude. For example, the peak-to-peak value of the waveform shown in Fig. 8 amounts to  $3 \times 20 \text{ mV} = 60 \text{ mV}$ . Note that the 3 % tolerance of the selected deflection coefficient may be reduced by setting the GAIN ADJ. control to the optimum position. The calibration voltage derived from the basic oscilloscope can be used for this purpose.

Fig. 9 shows the maximum permitted magnification (A) of a signal together with the portion of the signal (B) which may be displayed on the screen using the POSITION control.

The amplifier becomes overloaded if the x10 magnification is exceeded. In this case, the display becomes distorted and is therefore no longer proportional to the input waveform.

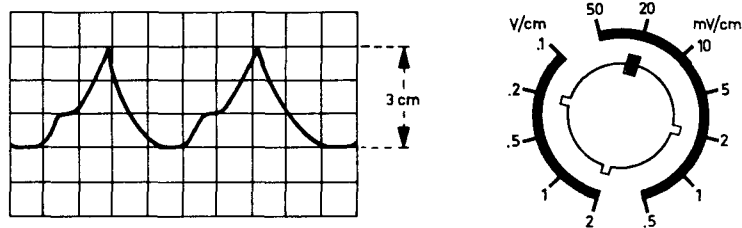

Fig. 8. Voltage measurement

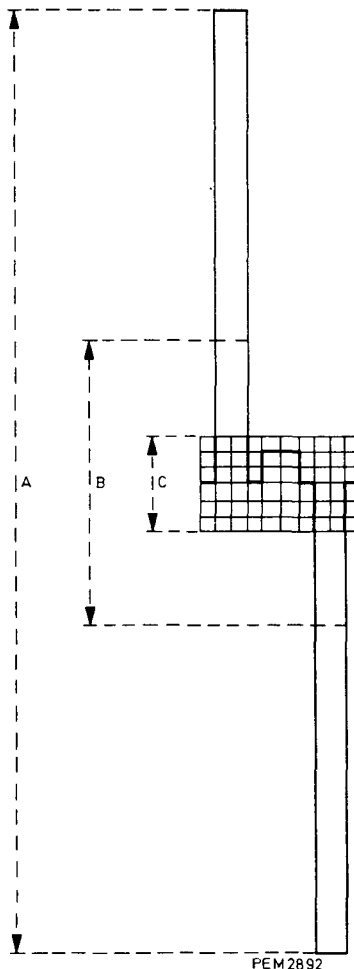

Fig. 9. Limits of Y-deflection

# Service Data

## Introduction



The preamplifier section consists of an a.c. coupled h.f. amplifier operating in parallel with a d.c. coupled l.f. amplifier. The outputs of the two amplifiers are combined by means of a crossover filter which acts as a high-pass filter for the h.f. amplifier and as a low-pass filter for the d.c. amplifier. The bandwidth of the h.f. amplifier is from 300 Hz to 100 MHz and that of the l.f. amplifier is 0 to 4 MHz. The  $-3$  dB point of the cross-over filter is 100 kHz. The configuration therefore provides a split-band amplifier with a total bandwidth of 0 to 100 MHz.

The advantages of split-band amplification are as follow:

### a. Lower noise

H.F. transistors suffer from a serious  $1/f$  noise at frequencies below 100 kHz, whilst l.f. transistors cause serious noise at higher frequencies. In addition to this, l.f. transistors fail to meet the required rise-times. However, in the split-band mode of operation, the best properties of each type of transistor is used in its own frequency range.

### b. Better d.c. bias

In a split-band amplifier it is possible to bias all the transistors for optimum collector current. (i.e. 10 mA for h.f. transistors and 1 mA for l.f. transistors).

### c. No necessity for constant dissipation networks

As the time constant of the thermal processes in h.f. transistors amounts to several milliseconds, and since

the h.f. amplifier is followed by a 100 kHz high-pass filter, there is no need to provide the h.f. amplifier with constant dissipation networks.

### d. Better decoupling of supply voltages

A common power supply is suitable owing to the use of RC coupling. Sufficient decoupling of the supply per stage is achieved without impairing the square wave response. The emitter resistors are connected to earth in order to avoid undue interstage coupling.

When the BANDWIDTH switch SK1 is set to the 0-100 kHz position, the a.c. coupled h.f. amplifier is isolated, so that the remaining d.c. coupled l.f. amplifier provides the 0-100 kHz bandwidth without h.f. noise.

At the four smallest deflection coefficients (i.e. 0.5 mV/cm, 1 mV/cm, 2 mV/cm and 5 mV/cm) the amplification factor of the split-band amplifier is increased due to a corresponding decrease in applied negative feedback. For larger values, impedance networks are inserted between the input terminal and the preamplifier. The required deflection coefficient is selected by means of the attenuator (mV/cm or V/cm) switch SK4. The d.c. coupled l.f. amplifier has an associated chopper amplifier whose output is used to counteract d.c. drift. Unlike the preamplifier, the output amplifier is entirely push-pull connected. Its output is channelled to both the Y-amplifier and trigger amplifier of the basic oscilloscope.

## Principles of the control-loop



The d.c. coupled l.f. amplifier input circuit consists of a differential amplifier. Input I receives signal  $V_i$  whilst input II receives control signal  $V_c$ . Drift voltages are referred to input I and it is assumed that they are delivered by a voltage source  $V_d$ .

The output of the d.c. coupled l.f. amplifier ( $V_o$ ) is attenuated by a factor A, at the 1/A attenuator. Voltage  $V_i$  is fed to one end of the voltage divider formed by R1 & R2 (fig. 10). The other end of this divider is supplied by voltage  $V_o/A$ .

Resistors R1 & R2 are both 1.11 MΩ and the input to the chopper amplifier is therefore  $1/2 (V_i + V_o/A)$ .

After amplification, this voltage becomes:

$$V_c = 1/2 B (V_i + V_o/A).$$

A voltage equal to  $V_i + V_d$  is applied to terminal I of the differential amplifier (input stage of the d.c. coupled

l.f. amplifier) whilst  $V_c$  is applied to terminal II. Since the difference is amplified by a factor of  $-A$ , the output  $V_o$  amounts to:

$$V_o = -A (V_i + V_d) - [-1/2 B (V_i + V_o/A)]$$

Extracting  $V_o$ ,

$$V_o = -A \left( V_i + \frac{V_d}{1 + 1/2 B} \right)$$

Since  $B \approx 1000$ , it is clear that drift is reduced by a factor of  $\approx 500$ . With the AC-DC switch SK3 set to AC, capacitor C102 is connected in series with R1 (Fig. 10) so that the voltage divider formed by R1 & R2 (Fig. 9) is blocked to d.c. Any leakage voltage of C26 is added to the voltage  $V_d$ : consequently, the new drift voltage

(i.e.  $V_d'$ ) will be reduced by the factor  $\frac{1}{1 + B}$

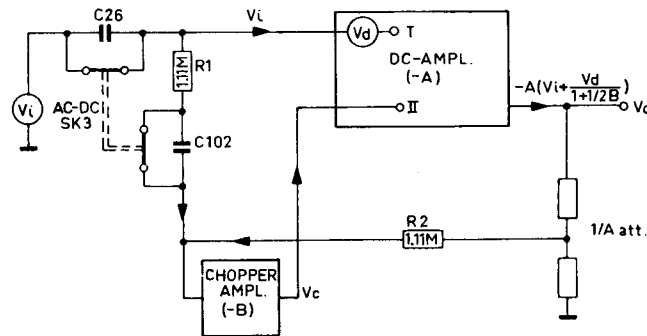

Fig. 10. Control loop

## Circuit description



### A. INPUT CIRCUIT

With the AC-DC switch set to AC, small a.c. signals superimposed upon a maximum of 400 V.d.c. may be observed. At the same time, relay RE101 is energized and this causes C102 to be connected into the comparison circuit which is represented by R1, R2 & C102 in Fig. 10.

The chopper amplifier therefore compensates for any d.c. component (due, for example, to leakage from C26) which is present at the input. Because switch SK3 is in the AC position, capacitor C26 can be charged by a d.c. input voltage.

When SK3 is transferred to DC, capacitor C26 is discharged in order to prevent damage which might otherwise occur to the circuit under test, when SK3 is returned to AC.

When the step attenuator is set to its four smallest deflection coefficients (i.e. 0.5 mV/cm, 1 mV/cm, 2 mV/cm and 5 mV/cm) no attenuation is applied to the input signal. Trimmers C18, C21, C24 and C29 enable the input capacitance to be adjusted to exactly 15 pF. For all the remaining deflection coefficients, attenuator networks are connected between the input terminal and source follower TS101. Trimmers C33, C36, C39, C43, C47, C51, C54, C58 enable the input capacitance to be adjusted to exactly 15 pF, whilst optimum square wave response can be obtained by means of C32, C34, C38, C42, C46, C49, C53, C57. The 1.11 M $\Omega$  resistor shown schematically as R1 in Fig. 10 is formed by two resistors (R102 & R103, 110 K $\Omega$  and 1 M $\Omega$  respectively) which are series-connected in order to form a value which results in a 1 M $\Omega$  input resistance. Note that the series combination formed by R102 and R103 is in parallel with the gate current compensation network which includes the 10 M $\Omega$  resistor R104. This gate compensation network (which also includes resistors R106, R107, R110, R115 & potentiometer R108) supplies either a positive or negative current, depending upon the setting of R108. This current is required by the source follower stage TS101 which supplies the input signal to the split band amplifier.

The CHECK ZERO push button switch SK2 when depressed disconnects the input signal and earths the source follower. This provides an indication of display zero level. Diode GR104 is for overload protection.

### B. H.F. AMPLIFIER

The a.c. component of the input signal is fed to the h.f. amplifier by way of the emitter follower TS102. The three stages of the amplifier, which are almost identical, each comprise a common emitter amplifier and emitter follower.

Each stage produces an output which is in antiphase to its input. The h.f. amplifier provides a 180 degree phase shift output in order to match the d.c. amplifier output. In the 2 mV/cm, 1 mV/cm and 0.5 mV/cm positions of the attenuator switch SK4, the gain of the h.f. amplifier is increased by a corresponding reduction in current feedback at the third, second, and first stage respectively. At these settings of switch SK4, the gain of the h.f. amplifier can be matched to that of the d.c. amplifier by choosing suitable values for the resistors tabulated below:

Switch position	Resistor	
	Coarse	Fine
5 mV/cm	R138	R139
2 mV/cm	R173	R174
1 mV/cm	R158	R159
0.5 mV/cm	R143	R144

The h.f. amplifier may be taken out of operation by setting the BANDWIDTH switch SK1 to its 0-100 kHz position. This isolates the supply to the second stage only.

### C. D.C. AMPLIFIER

The d.c. and l.f. components of the input signal are applied to the base of TS113 which, together with TS115, TS112 and TS114, forms a difference amplifier. The correction output of the chopper amplifier is applied to the source follower TS111, and then via emitter follower TS115 to the base of TS112. The difference between the two applied signals is fed, via emitter follower TS116, to a further two stages each of which comprises an amplifier and an emitter follower. At the final stage, zener diode GR107 provides a low impedance step-down of the d.c. level.

Upon selection of the four most sensitive deflection coefficients, the action of switch SK4 reduces the emitter resistance of TS117. Hence the overall gain of the d.c. amplifier is increased from x10 to x25, x50 and x100. An exact match with the 1/A attenuator can be obtained by adjustment of potentiometer R208.

### D. INTERSTAGE NETWORK

The outputs from the h.f. amplifier and the d.c. amplifier are combined by the cross-over filter R216 – C157 and the resulting output is fed to the emitter follower TS401. The 1/A attenuator, which consists of the precision resistors R406, R408, R409, R411 and R412, is connected to the emitter of TS401.



The output of TS401 is fed to the chopper amplifier via the 1.11 MΩ combination R300 & R305. The continuous gain control R2 is also connected to the emitter of TS401.

The output impedance of the two amplifiers is extremely small when compared with R216 & C157. Hence, the cross-over filter is seen by the h.f. amplifier as a high-pass filter with a cross-over frequency of 100 kHz; low frequency noise components and other l.f. signals generated within the h.f. amplifier are therefore suppressed.

However, the l.f. amplifier sees the cross-over filter as a low-pass filter with a 100 kHz cross-over frequency, so that h.f. noise or other h.f. signals generated within the l.f. amplifier are suppressed.

An input signal  $V_i$  applied to the split band amplifier (see Fig. 12) causes an output signal  $\alpha_1 \times V_i$  at point a and an output signal of  $\alpha_2 \times V_i$  at point b (where

$\alpha_1$  is the gain of the h.f. amplifier and  $\alpha_2$  the gain of the l.f. amplifier). At frequencies where  $\alpha_1 \approx \alpha_2 \approx \alpha$  ( $\alpha$  being the desired overall gain) the output at point a is equal to that at point b and no current will flow through the interstage network.

The output at point c will then be equal to  $\alpha V_i$ . At low frequencies,  $\alpha_1$  is smaller than  $\alpha_2$  and  $\alpha_2$  equals  $\alpha$ . In this case, the output at point a is smaller than that at point b so that the current flowing through the R216 & C157 combination will cause it to act as a low pass filter to the output at point b.

At high frequencies,  $\alpha_2$  is smaller than  $\alpha_1$  and  $\alpha_1$  equals  $\alpha$  so that the output at point b is smaller than the output at point a. The current which then flows through the R216 and C157 combination causes it to act as a high-pass filter to the output at point a.

Since  $\alpha_1 V_i = \alpha V_i$ , the output at point c equals the output at point a.

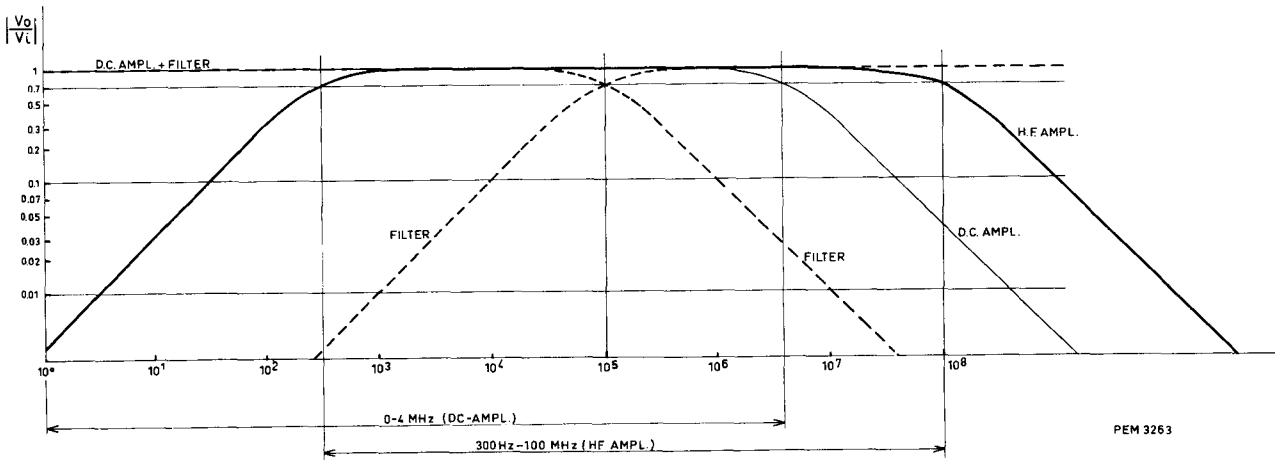

Fig. 11. Bandwidth characteristics

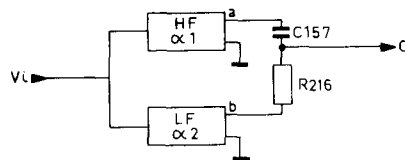

Fig. 12. Operation of the crossover filter

**E. CHOPPER AMPLIFIER (Fig. 26)**

The chopper amplifier consists of the following four stages:

- Chopper input
- Operational amplifier
- Top detector
- Chopper driver

**1. Chopper input**

The input signal  $V_i$  is passed to the chopper input circuit via connector BU A and is combined with the sum of its replica and drift component (i.e.  $-V_i - V_d \frac{1}{1 + 1/2B}$ ) from the split-band amplifier.

The integrating action of R301 & C302 adds the two inputs and the result ( $-V_d \frac{1}{1 + 1/2B}$ ) is passed to the series and parallel chopper TS301 and TS302. Source follower TS303 passes the signal to the operations amplifier. Diodes GR301 and GR302 protect the chopper input in the event of the d.c. portion of the split-band amplifier being over-driven.

**2. Operational amplifier**

Square wave signals obtained from source follower TS303 are passed to the inverting input terminal 3 of the operational amplifier. At the same time, the non-inverting terminal 2 is supplied with a feedback signal which determines the amplification factor.

This amplification factor is a ratio of R316/R312 = 1.2 MΩ/1.2 kΩ = 1000.

The output of the operational amplifier is clamped against earth and limited to a maximum of 6 V by zener diode GR304.

**3. Top detector**

The MOS field effect transistors TS304 and TS306 act as bi-directional switches that control the charge of capacitor C321. The polarity of capacitor C321 charge therefore depends upon the phase of the driver signals present at these gates, with respect to the square wave pulses from zener diode GR304. The junction of TS306 and C321 is connected to a steady (although adjustable) voltage level obtained from potentiometer R246 and its associated network. The junction of TS304 and C321 is connected to the second input of the d.c. amplifier section, as a voltage

$$V_d \frac{1/2 B}{1 + 1/2 B} \approx V_d, \text{ (since } B = 1000)$$

For correct operation, the chopper input must operate in synchronism with the top detector. The phase shift components R304 and C308 provide the means by which this synchronism may be set up.

**4. Chopper driver**

The chopper driver stage is an astable multivibrator circuit which operates at a frequency of 2 kHz. Diodes GR306 and GR311 connected in the output lines, together with GR307 and GR312 in the collector circuits, ensure an output waveform which has extremely steep leading and trailing edges. Zener diode GR309 stabilizes the circuit supply voltage whilst diodes GR308 and GR313 block excessive base-emitter voltages.

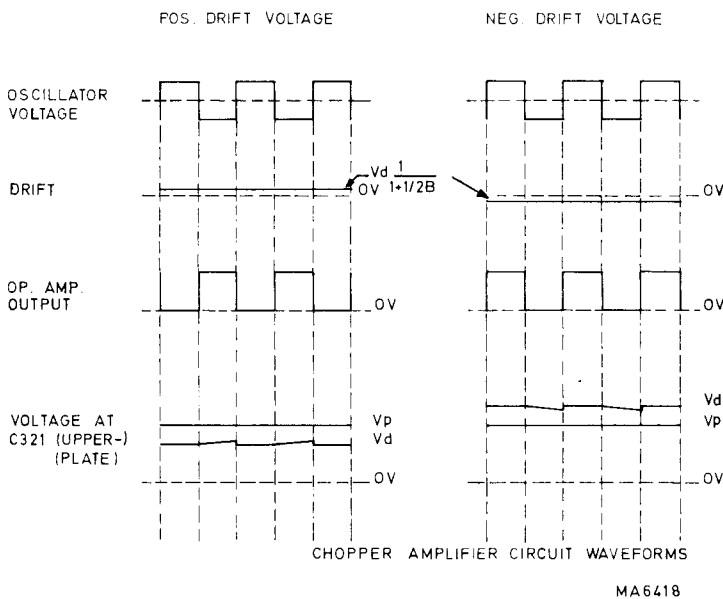

Fig. 13. Chopper amplifier circuit waveforms

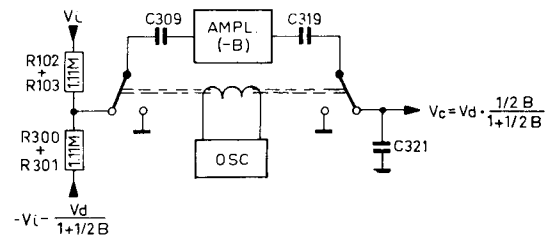

Fig. 14. Operation of the demodulator

## F. FINAL AMPLIFIER

The input stage of the final amplifier consists of an asymmetrically driven longtailed pair. The input signal is applied, via emitter-follower TS402, to the base of TS404. Shift control is applied via TS403 to the base of TS406.

The preset potentiometer R1, connected at the emitter side of the long-tailed pair, provides adjustment of the deflection coefficient. Optimum rise time adjustment is by means of C408, C416, R437. The output stage is formed by two pairs of emitter-followers and these provide a fast rise and fall of square wave signals despite the capacitive load of the Y-amplifier and trigger amplifier.

Input signals are applied to the emitter-follower pairs by way of the forward biased diodes whose standing current is set by potentiometers R449 and R457

Assume that the collector voltage of TS404 rises: the current through GR403 decreases so that the current through GR404 increases.

Transistor TS407 then becomes more conductive due

to the increase in its base current, and its output is consequently more positive. At the same time, transistor TS408 is made less conductive due to a decrease in its base current caused by the increase in current through diode GR404. Because TS408 is less conductive, it presents a high impedance to emitter follower TS407. Hence the capacitance present at the output of the final amplifier is charged from a low ohmic current source. As the voltage at the collector of TS404 rises, the voltage at the collector of TS406 falls.

The current through GR406 will decrease so that transistor TS409 is switched on. The output capacitance discharges rapidly through this low ohmic path.

The output of the final amplifier is passed directly to the Y-amplifier of the basic oscilloscope via terminals 1BU-Y and 17BU-Y. The trigger amplifier receives the same outputs via R471 and R472 which are connected to 16BU-Y and 32BU-Y respectively.

## Checking and adjusting



### A. GENERAL INFORMATION

The tolerances specified in this section are factory tolerances: they apply to a fully-adjusted instrument. They may differ from the data given in chapter II. A summary of the controls and adjustments is given in chapter V. With this information, it will be possible to perform all the adjustments to the h.f. amplifier PM 3332/04. The amplifier must be inserted into the Y-plug-in compartment of a correctly-adjusted basic oscilloscope PM 3330, resp. PM 3370. The controls situated on the right hand side of the unit are not directly accessible, so that the rigid extension plug (code number 4822 263 70009) must be used to provide access to them.

When a complete checking and adjusting procedure is made, the following sequence of operations should be observed.

### B. CHOPPER AMPLIFIER

- If a signal is visible of about 2 kHz at the .5 mV/cm position while the input is earthed (e.g. CHECK ZERO depressed) and/or R246 runs out of its control range the chopper amplifier needs adjustment.

The chopper amplifier may be removed from its housing after the withdrawal of lid "A" (Fig. 15) a five-pole plug, a three-pole plug and a single-pole plug. If measurements are made while the chopper amplifier is out of its housing, adequate screening precautions should be taken to avoid hum.

- Make the following connections to the five-pole plug.
  - (a) Connect the screen and common return of a +12 V and –12 V supply circuit to pin 1 (grey).
  - (b) Connect the –12 V line to pin 2 (brown)
  - (c) Connect the +12 V line to pin 5 (green)
- Connect a 500 k $\Omega$  resistor between pins 1 and 2 of the three-pole plug.
- Interconnect EARTH1 and EARTH2
- Connect an oscilloscope to pin 2 of the three-pole plug, using pin 3 as reference. Adjust C308 for minimum ripple.
- Remove the oscilloscope connection from pin 2 and reconnect it to zener diode GR304. Adjust R304 for minimum square wave amplitude.
- Repeat the adjustments for optimum results.
- Apply a 1 mV negative voltage (obtained from a suitable potential divider connected to a 12 V supply

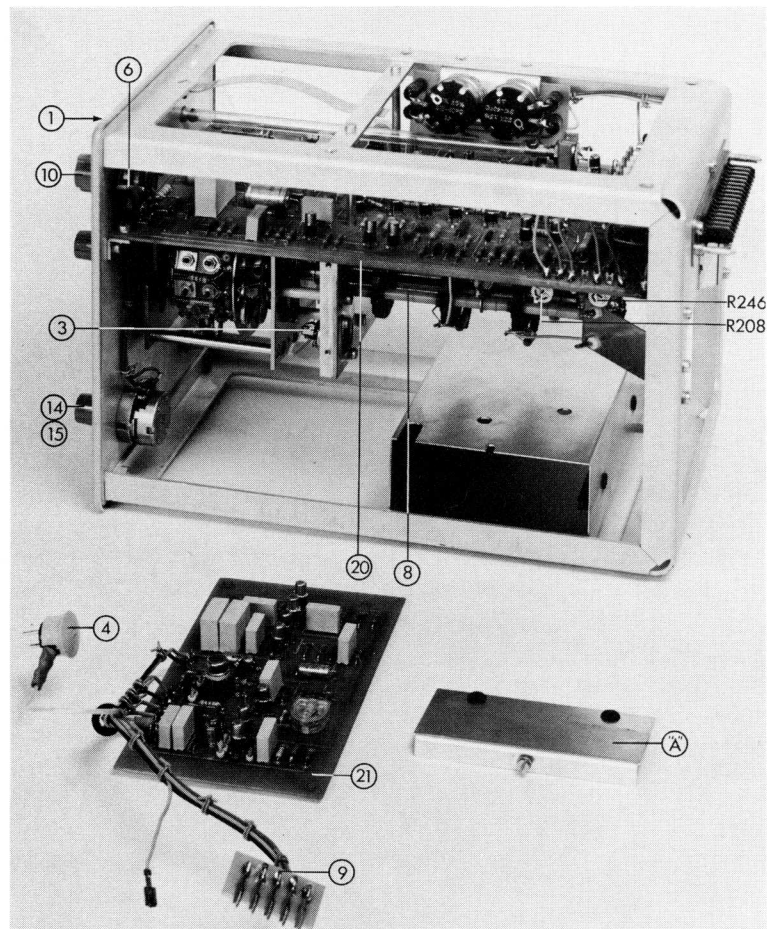

Fig. 15. Right hand side of amplifier

or dry cell) via a 500 k $\Omega$  resistor, to pin 2 of the three-pole plug. Connect pin 1 to the common terminal of the potential divider, and earth pin 3 by connecting to the grey lead of the five-pole plug.

- Connect a 1 M $\Omega$  resistor across the two remaining pins of the five-pole plug.

The voltage across this resistor should be 1 V, and the orange wire should be negative with respect to the black wire.

- Increase the input voltage to 3 mV. The output should then be at least 3 V.
- Check that the chopper frequency is 2 kHz  $\pm$ 10 % by connecting an oscilloscope across zener diode GR304.
- Reverse the polarity of the input voltage and check that the output voltage is at least 3 V. Preferably it should retain its former value.
- Disconnect the voltage from the three-pole plug and connect pin 2 to pin 3.  
The output should be less than 20 mV.
- Remove the connection between pins 2 and 3. The noise must not exceed an r.m.s. value of 50 mV.

### C. GATE CURRENT COMPENSATION

#### R108 (Fig. 16)

- Set the controls of the basic oscilloscope as follows:

- TRIGG MODE to AUT
  - TRIGG SOURCE to INT
  - TIME/cm to 5 msec/cm
  - X-DEFLECTION to TIME BASE A resp. MAIN TB
- Set the amplifier V/cm switch SK4 to 0.5 mV/cm and R2 to its CAL position.  
AC-DC SK3 to position DC.
  - Position the trace in the centre of the screen using the SHIFT (R3) control.
  - Adjust the I<sub>g</sub> COMP control R108 for a condition in which no jump of the trace occurs while the CHECK ZERO switch SK2 is repeatedly depressed.

### D. BALANCE ADJUSTMENT

#### R246 (Fig. 15) R449, R457 (Fig. 16)

Connect the amplifier to the basic oscilloscope using the extension cable (code nr. 4822 263 70008).

- Set the V/cm switch SK4 to 0.5 mV/cm. With the CHECK ZERO switch SK3 depressed, quickly rotate the V/cm control R2. Eliminate any vertical movement of the trace using R246. Put the trace in the middle of the screen by POSITION R3.
- Adjust R449 and R457 until the voltage drop across each of the combinations R463 & R464 and R466 & R467 is 80 mV.

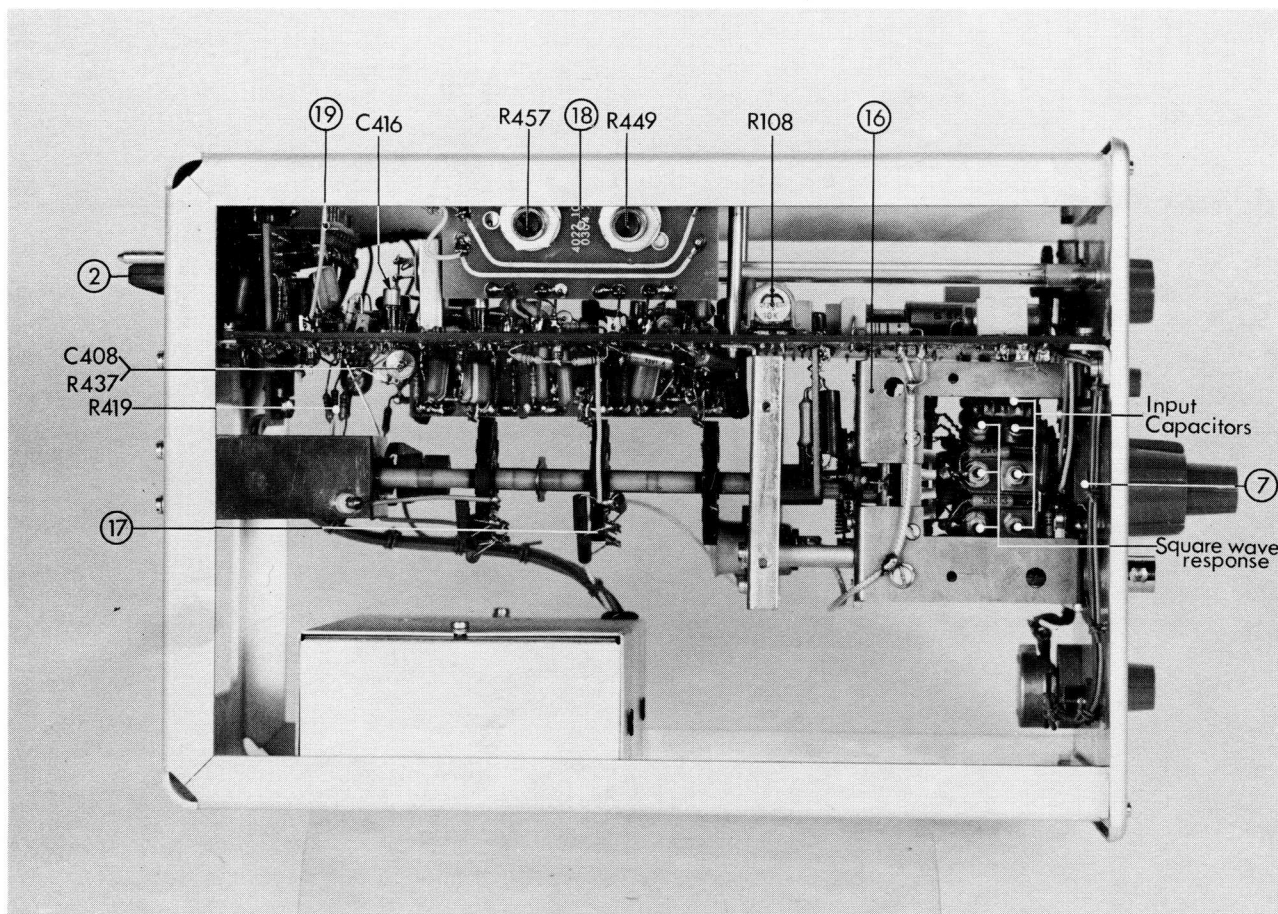

Fig. 16. Left hand side of amplifier

## E. DEFLECTION COEFFICIENT

- Set the deflection coefficient switch SK4 to 5 mV/cm and the continuous gain control R2 to CAL.
- Apply a 20 mV/cm calibration voltage to the input of the PM 3332 amplifier.
- Adjust the trace height to exactly 40 mm using the GAIN ADJ. control R2.
- Check that it is possible to reduce the trace height to below 16 mm, by means of the continuous gain control R2.

## F. SQUARE WAVE RESPONSE

**R208 (Fig. 15), C408, C416, R437 (Fig. 16), C128, C130, C158, R138, R139, R140, R141, R143, R144, R145, R158, R159, R173 & R174 (Fig.24)**

- Unsolder R419 (Fig. 16) at the side of the potentiometer R2 and apply a square wave voltage with a rise time of about 1 ns via a terminated 50  $\Omega$  cable. For a 4 cm deflection the amplitude must be about 200 mV.
- With C408, C416 and R437 adjust for a correct square wave response.
- Connect the amplifier to the basic oscilloscope using the rigid extension plug (code nr. 4822 263 70009) and set the V/cm switch SK4 to 5 mV/cm.
- Apply a square wave voltage with a repetition frequency of 10 Hz and an amplitude which produces a 4 cm display height.
- Adjust R208 so that the square wave display has a flat top.
- Increase the frequency of the signal to 100 kHz and change its peak-to-peak amplitude to 20 mV. Optimum square wave response is obtained by adjusting the gain of the h.f. amplifier so that it is exactly equal to the gain of the d.c. amplifier. The necessary adjustment to the h.f. amplifier is made by selecting a critical value for several emitter resistors, in accordance with the following table:

Position of SK3	Amplitude of 100 kHz signal	Selected resistor (first 5 $\mu$ s)		If necessary correction networks (first 1 $\mu$ s)
		Coarse	Fine	
5 mV/cm	20 mV <sub>p-p</sub>	R138	R139	R140; R141 + C125
2 mV/cm	8 mV <sub>p-p</sub>	R173	R174	R175 + C158
1 mV/cm	4 mV <sub>p-p</sub>	R158	R159	
0.5 mV/cm	2 mV <sub>p-p</sub>	R143	R144	R145 + C130

**Note:** Adjust the display with the coarse selected resistor so that some rounding-off is present. Then adjust the display with the fine resistor in order to eliminate any overshoot.

- Remove the extension plug and apply a square wave having about a 1 ns rise time, a frequency of about 100 kHz and an amplitude of 20 mV.

- Set the controls of the basic oscilloscope as follows:
  - a. TRIGG MODE to H.F.
  - b. TRIGG SOURCE to INT
  - c. TIME/cm to 0.05  $\mu$ sec/cm
  - d. MAGN to x5 resp. x10
- Set the V/cm switch SK4 of the PM 3332 to 5 mV/cm.
- Check the square wave response and if necessary readjust slightly C408, C416 and/or R437. The rise time must be smaller than 7 ns; aberration smaller than 3 %.

## G. FREQUENCY RESPONSE CURVE

After adjustment of the square wave response (point D) and the deflection coefficient (point E) the  $-3$  dB point, of the amplifier should exceed 50 MHz. The frequency response curve can be measured with the aid of a constant amplitude generator and a terminated 50  $\Omega$  cable.

- Set the mode switch to "AUTO"
- Set the V/cm switch SK4 of the amplifier to 5 mV/cm and the V/cm control R2 to its CAL position.
- Switch the generator frequency to 15 MHz and adjust the output voltage to a 40 mm trace height.
- Increase the frequency to 50 MHz. The trace height should exceed 28 mm.

## H. DEFLECTION AND SHIFT

Ensure that the d.c. balance and sensitivity have been correctly adjusted before making this measurement.

- Set the AC-DC switch SK3 to AC, the V/cm switch to 5 mV/cm and the V/cm control to CAL.
- Set the TIME/cm control of the basic oscilloscope to 0.2 msec/cm.
- Apply a triangular or sinusoidal signal at a frequency of 2 kHz and an amplitude of 90 mV<sub>p-p</sub>.
- The range of the POSITION control R3 should be large enough to bring the tops of the trace within the screen measuring graticule.
- With this triple overdriving, no distortion should occur.

## I. AC-DC SWITCH; CHECK ZERO

- Set the controls of the amplifier as follows:
  - a. AC-DC switch SK3 to DC
  - b. V/cm switch SK4 to 1 V/cm
  - c. V/cm control R2 to CAL
- Apply a 4 V calibration voltage to the input of the amplifier.
- Adjust the POSITION control R3 so that the lower side of the trace coincides with the centre-line of the screen.
- Set the AC-DC switch SK3 to AC. The d.c. components of the calibration voltage should now be blocked, as a result of which the trace should be written symmetrically around the centre of the screen.
- Slowly depress the CHECK ZERO button switch SK2. The differentiated form of the signal should be seen before the display completely disappears.

**J. INPUT ATTENUATOR**

**1. Attenuation and square wave response**

For adjustment of the attenuator in each position of the deflection coefficient switch SK4, the corresponding trimmers are accessible through holes in the screening plate.

- Apply the calibration voltage of an oscilloscope calibrator (e.g. Bradley type 156).
- After proper adjustment of the deflection coefficient (point E), the trace height should be exactly 40 mm  $\pm 2\%$ ,
- At the same time, adjust the trimmers listed in the following table for optimum square wave response:

Calibration voltage	V/cm (switch SK4)	Trimmer
2 mV	0.5 mV/cm	
4 mV	1 mV/cm	
8 mV	2 mV/cm	
20 mV	5 mV/cm	
40 mV	10 mV/cm	C32
80 mV	20 mV/cm	C34
0.2 V	50 mV/cm	C38
0.4 V	0.1 V/cm	C42
0.8 V	0.2 V/cm	C46
2.0 V	0.5 V/cm	C49
4.0 V	1.0 V/cm	C53
8.0 V	2.0 V/cm	C57

**2. Input capacitance**

With the aid of an RC standardizer (Fig. 17) such as Tektronix cat. No. 011-0073-00 BNC, the input capacitance can be adjusted to 15 pF in all positions of switch SK4.

- Apply the calibration voltage from the oscilloscope calibrator via the standardizer to the input of the PM 3332 amplifier.
- Adjust the input capacitance using the trimmers listed in the following table, in order to obtain optimum square wave response.

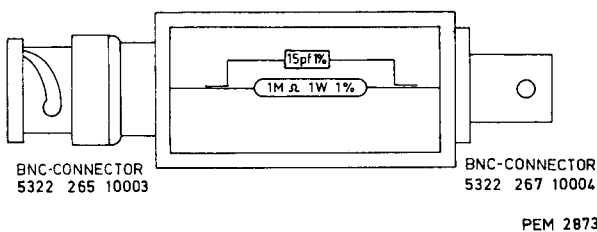

Fig. 17. Input RC standardizer

Calibration voltage (from PM 3330)	Deflection coefficient (SK4)	Trimmer
4 mV	0.5 mV/cm	C18
8 mV	1 mV/cm	C21
20 mV	2 mV/cm	C24
40 mV	5 mV/cm	C29
80 mV	10 mV/cm	C33
0.2 V	20 mV/cm	C36
0.4 V	50 mV/cm	C39
0.8 V	0.1 V/cm	C43
2 V	0.2 V/cm	C47
4 V	0.5 V/cm	C51
8 V	1 V/cm	C54
20 V	2 V/cm	C58

**K. TRIGGERING**

- Set the below mentioned selectors in the mentioned positions  
 TRIGG. MODE : HF  
 TRIGG. SLOPE : +  
 TRIGG. SOURCE: INT.
- Apply a 10 MHz sine wave and adjust for a 3 mm trace height.
- It must be possible to obtain a well triggered trace by operating the LEVEL potentiometer.
- Reduce the frequency to e.g. 100 kHz and check that the trace starts with a positive going slope.
- Increase the frequency to 50 MHz and the amplitude for a 2 cm trace height.
- It must be possible to obtain a well triggered trace by operating the LEVEL potentiometer.

**L. PROBE POWER**

- Check the presence of output voltages as indicated in Fig. 18.

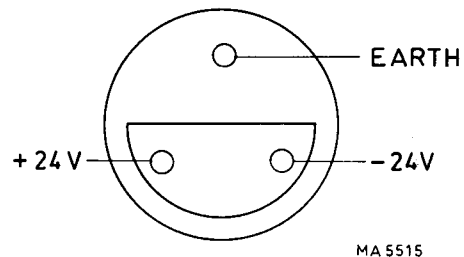

Fig. 18. Probe power outlet

## List of service parts

### A. MECHANICAL PARTS

<i>Item</i>	<i>Fig.</i>	<i>Code number</i>	<i>Description</i>	<i>Qty.</i>
1	15	5322 454 40035	Textplate	1
2	16	5322 265 60002	Connector	1
3	15	5322 267 40039	Socket	1
4	15	5322 264 40021	Plug	1
5	2	5322 413 30164	Push button (SK2)	1
6	15	5322 273 30133	Switch SK1	1
7	16	5322 277 24001	Switch SK3	1
8	15	5322 273 70013	Switch SK4	1
9	15	5322 265 40037	Plug (panel)	1
10	15	5322 413 30084	Knob	1
11	3	5322 413 40112	Knob (SK4)	1
12	3	5322 413 30085	Knob (R2)	1
13	3	5322 413 70039	Cap (R2)	1
14	15	5322 413 30082	Knob	1
15	15	5322 413 70038	Cap	2
16	16	5322 216 54035	Unit 4 (Attenuator)	1
17	16	5322 105 34004	Unit 5 (Attenuator switch)	1
18	16	5322 214 10032	Unit 6 (Output adjustment)	1
19	16	5322 216 54036	Unit 7 (Supply filter)	1
20	15	5322 216 54037	Unit 11 (Amplifier)	1
21	15	5322 216 54038	Unit 12 (Chopper amplifier)	1



**B. ELECTRICAL — ELEKTRISCH — ELEKTRISCH — ELECTRIQUE — ELECTRICOS**



















This parts list does not contain multi-purpose and standard parts. These components are indicated in the circuit diagram by means of identification marks. The specification can be derived from the survey below.

Diese Ersatzteilliste enthält keine Universal- und Standard-Teile. Diese sind im jeweiligen Prinzipschaltbild mit Kennzeichnungen versehen. Die Spezifikation kann aus nachstehender Übersicht abgeleitet werden.

In deze stuklijst zijn geen universele en standaardonderdelen opgenomen. Deze componenten zijn in het principeschema met een merkteken aangegeven. De specificatie van deze merktekens is hieronder vermeld.

La présente liste ne contient pas des pièces universelles et standard. Celles-ci ont été repérées dans le schéma de principe. Leurs spécifications sont indiquées ci-dessous.

Esta lista de componentes no comprende componentes universales ni standard. Estos componentes están provistos en el esquema de principio de una marca. El significado de estas marcas se indica a continuación.

	Carbon resistor E24 series Kohleschichtwiderstand, Reihe E24 Koolweerstand E24 reeks Résistance au carbone, série E24 Resistencia de carbón, serie E24	} 0,125 W	5%		Carbon resistor E12 series Kohleschichtwiderstand, Reihe E12 Koolweerstand E12 reeks Résistance au carbone, série E12 Resistencia de carbón, serie E12	} 1	W ≤ 2,2 MΩ, 5% > 2,2 MΩ, 10%
	Carbon resistor E12 series Kohleschichtwiderstand, Reihe E12 Koolweerstand E12 reeks Résistance au carbone, série E12 Resistencia de carbón, serie E12			} 0,25 W ≤ 1 MΩ, 5% > 1 MΩ, 10%			
	Carbon resistor E24 series Kohleschichtwiderstand, Reihe E24 Koolweerstand E24 reeks Résistance au carbone, série E24 Resistencia de carbón, serie E24	} 0,5 W ≤ 5 MΩ, 1% > 5 MΩ, 2% > 10 MΩ, 5%			Wire-wound resistor Drahtwiderstand Draadgewonden weerstand Résistance bobinée Resistencia bobinada	} 0,4 – 1,8 W	0,5%
	Carbon resistor E12 series Kohleschichtwiderstand, Reihe E12 Koolweerstand E12 reeks Résistance au carbone, série E12 Resistencia de carbón, serie E12		} 0,5 W ≤ 1,5 MΩ, 5% > 1,5 MΩ, 10%		Wire-wound resistor Drahtwiderstand Draadgewonden weerstand Résistance bobinée Resistencia bobinada		
	Wire-wound resistor Drahtwiderstand Draadgewonden weerstand Résistance bobinée Resistencia bobinada	} 10 W		5%		Tubular ceramic capacitor Rohrkondensator Keramische kondensator, buistype Condensateur céramique tubulaire Condensador cerámico tubular	} 500 V
	Tubular ceramic capacitor Rohrkondensator Keramische kondensator, buistype Condensateur céramique tubulaire Condensador cerámico tubular		} 700 V			Polyester capacitor Polyesterkondensator Polyesterkondensator Condensateur au polyester Condensador polyester	
	Ceramic capacitor, "pin-up" Keramikkondensator "Pin-up" (Perltyp) Keramische kondensator "Pin-up" type Condensateur céramique, type perle Condensador cerámico, versión "colgable"	} 500 V			Flat-foil polyester capacitor Miniatur-Polyesterkondensator (flach) Platte miniatuur polyesterkondensator Condensateur au polyester, type plat Condensador polyester, tipo de placas planas	} 250 V	
	"Microplate" ceramic capacitor Miniatur-Scheibenkondensator "Microplate" keramische kondensator Condensateur céramique "microplate" Condensador cerámico "microplaca"		} 30 V		Paper capacitor Papierkondensator Papierkondensator Condensateur au papier Condensador de papel		} 1000 V
	Mica capacitor Glimmerkondensator Micakondensator Condensateur au mica Condensador de mica	} 500 V			Wire-wound trimmer Drahttrimmer Draadgewonden trimmer Trimmer à fil Trimmer bobinado		
	Tubular ceramic trimmer Rohrtrimmer Buisvormige keramische trimmer Trimmer céramique tubulaire Trimmer cerámico tubular						



For multi-purpose and standard parts, please see PHILIPS' Service Catalogue.

Für die Universal- und Standard-Teile siehe den PHILIPS Service-Katalog.

Voor universele en standaardonderdelen raadplege men de PHILIPS Service Catalogus.

Pour les pièces universelles et standard veuillez consulter le Catalogue Service PHILIPS.

Para piezas universales y standard consulte el Catálogo de Servicio PHILIPS.

## RESISTORS

<i>Number</i>	<i>Code number</i>	<i>Value</i>		<i>Watts</i>	<i>%</i>	<i>Description</i>
R1	5322 100 20011	500	ohm			Potentiometer
R2	5322 101 20361	200	ohm			Potentiometer
R3	5322 101 20109	10	kohm			Potentiometer
R23, 24, 25, 28	5322 111 30069	39	ohm	0.1	5	Carbon
R26	5322 111 30273	10	kohm	0.1	5	Carbon
R29	5322 111 20329	500	kohm	0.125	1	Carbon
R31	5322 111 20317	1	Mohm	0.125	1	Carbon
R32	5322 111 20328	750	kohm	0.125	1	Carbon
R33	5322 111 20142	333	kohm	0.125	1	Carbon
R34	5322 111 20321	900	kohm	0.125	1	Carbon
R36	5322 116 50017	111	kohm	0.125	1	Carbon
R37	5322 111 20146	950	kohm	0.125	1	Carbon
R38	5322 116 50841	52.6	kohm	0.125	1	Carbon
R39	5322 111 20253	975	kohm	0.125	1	Carbon
R41	5322 111 20254	25.6	kohm	0.125	1	Carbon
R42	5322 111 20331	990	kohm	0.125	1	Carbon
R43	5322 116 50284	10.1	kohm	0.125	1	Carbon
R44	5322 111 20237	995	kohm	0.125	1	Carbon
R46	5322 111 20238	5.03	kohm	0.125	1	Carbon
R47	5322 111 20317	1	Mohm	0.125	1	Carbon
R48	5322 116 50543	2.50	kohm	0.125	1	Carbon
R102	5322 111 20035	110	kohm	0.125	1	Carbon
R103	5322 116 50022	1	Mohm	0.25	0.25	Metal film
R104	5322 110 30214	10	Mohm	0.25	2	Carbon
R108	5322 101 14012	10	kohm			Potentiometer
R134	5322 116 50416	332	ohm	0.25	1	Metal film
R137, 142	5322 116 50528	82.5	ohm	0.25	1	Metal film
R152	5322 116 50416	332	ohm	0.25	1	Metal film
R154	5322 116 50751	150	ohm	0.25	1	Metal film
R157	5322 116 50746	100	ohm	0.25	1	Metal film
R167	5322 116 50416	332	ohm	0.25	1	Metal film
R169	5322 116 50003	121	ohm	0.25	1	Metal film
R191	5322 111 20309	910	ohm	0.125	1	Carbon
R193	5322 116 50158	5.1	kohm	0.125	1	Carbon
R194	5322 116 50463	10	kohm	0.125	1	Carbon
R198	5322 116 50614	3.6	kohm	0.125	1	Carbon
R199	5322 116 50104	6.8	kohm	0.125	0.25	Metal film
R201	5322 116 50225	590	ohm	0.125	0.25	Metal film
R202	5322 116 50226	780	ohm	0.125	0.25	Metal film
R203	5322 116 50227	2.28	kohm	0.125	0.25	Metal film
R205	5322 116 50421	31.6	kohm	0.125	0.25	Metal film
R206	5322 116 50878	1.3	kohm	0.125	1	Carbon
R207	5322 116 50183	1.6	kohm	0.125	1	Carbon
R208	5322 101 14012	10	kohm			Potentiometer
R209	5322 116 50293	1.5	kohm	0.125	1	Carbon
R211	5322 116 50091	330	ohm	0.125	1	Carbon
R212	5322 116 50086	220	ohm	0.125	1	Carbon
R216	5322 116 50274	1	kohm	0.125	1	Carbon
R246	5322 101 14012	10	kohm			Potentiometer
R300	5322 116 50022	1	Mohm	0.25	0.25	Metal film

<i>Number</i>	<i>Code number</i>	<i>Value</i>		<i>Watts</i>	<i>%</i>	<i>Description</i>
R301	5322 111 30277	22	kohm	0.1	5	Carbon
R302	5322 116 50404	3.32	kohm	0.25	1	Metal film
R303, 306	5322 116 50244	100	kohm	0.25	1	Metal film
R304	5322 101 14001	1	Mohm			Potentiometer
R305	5322 111 20035	110	kohm	0.125	1	Carbon
R307	5322 111 30269	1	kohm	0.1	5	Carbon
R308	5322 111 30277	22	kohm	0.1	5	Carbon
R309	5322 111 30342	10	Mohm	0.125	10	Carbon
R311	5322 116 50747	1	kohm	0.25	1	Metal film
R312	5322 111 30268	1.2	kohm	0.1	5	Carbon
R317	5322 111 30265	2.2	kohm	0.1	5	Carbon
R318	5322 116 50482	33.2	kohm	0.25	1	Metal film
R319	5322 116 50244	100	kohm	0.25	1	Metal film
R320	5322 111 30383	68	ohm	0.1	5	Carbon
R321	5322 116 50956	562	ohm	0.25	1	Metal film
R322	5322 116 50976	56.2	kohm	0.25	1	Metal film
R323	5322 116 54011	5.62	kohm	0.25	1	Metal film
R324	5322 116 50675	2.26	kohm	0.25	1	Metal film
R326, 329	5322 116 50979	8.25	kohm	0.25	1	Metal film
R327, 328	5322 116 50976	56.2	kohm	0.25	1	Metal film
R331	5322 116 54011	5.62	kohm	0.25	1	Metal film
R332	5322 116 50675	2.26	kohm	0.25	1	Metal film
R333	5322 116 50976	56.2	kohm	0.25	1	Metal film
R334	5322 116 50347	82.5	ohm	0.25	1	Metal film
R406	5322 116 50228	98.9	kohm	0.125	0.5	Metal film
R407	5322 111 30074	56	ohm	0.1	5	Carbon
R408	5322 116 50274	1	kohm	0.125	0.25	Metal film
R409	5322 116 50229	1.02	kohm	0.125	0.25	Metal film
R411	5322 116 50231	2.12	kohm	0.125	0.25	Metal film
R412	5322 116 50232	6.96	kohm	0.125	0.25	Metal film
R417	5322 116 50746	100	ohm	0.25	1	Metal film
R437	5322 100 10149	100	ohm			Potentiometer
R447	5322 111 44013	33	kohm	0.25	5	Carbon
R449, 457	5322 103 20175	22	kohm	3		Potentiometer
R452, 456	5322 111 44013	33	kohm	0.25	5	Carbon
R461	5322 111 44013	33	kohm	0.25	5	Carbon

## CAPACITORS

<i>Number</i>	<i>Code number</i>	<i>Value</i>	<i>Volts</i>	<i>Description</i>
C18, 21, 24	4822 125 60045	68 pF		Trimmer (cer)
C29, 32, 33	4822 125 60045	68 pF		Trimmer (cer)
C34, 36, 38	4822 125 60045	68 pF		Trimmer (cer)
C39, 42, 43	4822 125 60045	68 pF		Trimmer (cer)
C46, 47, 49	4822 125 60045	68 pF		Trimmer (cer)
C51, 53, 54	4822 125 60045	68 pF		Trimmer (cer)
C57, 58	4822 125 60045	68 pF		Trimmer (cer)
C26	5322 121 20083	0.1 $\mu$ F	300	Paper
C37	4822 120 20054	9 pF	500	Ceramic
C41	5322 123 10165	27 pF	300	Button
C44	5322 123 10166	56 pF	300	Button
C48	5322 123 10167	150 pF	300	Button
C52	5322 123 10168	300 pF	300	Button
C56	5322 123 10169	600 pF	300	Button
C59	5322 123 10171	1500 pF	300	Button
C63	5322 123 10172	2400 pF	300	Button
C101	4822 124 20402	250 $\mu$ F	16	Electrolytic
C102	5322 121 40095	0.12 $\mu$ F	250	Polyester
C106	5322 121 40057	68 nF	100	Polyester
C107	5322 121 40232	0.22 $\mu$ F	100	Polyester
C109	5322 121 40057	0.068 $\mu$ F	250	Plate
C118, 121	5322 121 40057	0.068 $\mu$ F	250	Plate
C128, 133, 138	5322 121 40057	0.068 $\mu$ F	250	Plate
C144, 149, 156	5322 121 40057	0.068 $\mu$ F	250	Plate
C119	5322 121 40099	0.33 $\mu$ F	60	Polyester
C116, 123, 126, 131	4822 124 10014	4.7 $\mu$ F	35	Tantalum
C136, 142, 147	4822 124 10014	4.7 $\mu$ F	35	Tantalum
C153	4822 124 10014	4.7 $\mu$ F	35	Tantalum
C117, 122, 127	5322 122 70055	4700 pF	350	Feed through
C132, 137, 143	5322 122 70055	4700 pF	350	Feed through
C148, 154, 166	5322 122 70055	4700 pF	350	Feed through
C167, 168, 169	5322 122 70055	4700 pF	350	Feed through
C171, 174	5322 122 70055	4700 pF	350	Feed through
C134, 146	5322 121 40099	0.33 $\mu$ F	60	Polyester
C157	4822 120 60113	1600 pF	500	Mica
C163	5322 122 70065	68 pF	350	Feed through
C165	4822 122 70003	1.5 nF	350	Feed through
C172	5322 121 40283	3.3 $\mu$ F	100	Polyester
C173	5322 121 40232	0.22 $\mu$ F	100	Polyester
C175, 176	5322 124 10026	47 $\mu$ F	20	Tantalum
C302, 323, 324	5322 121 40047	0.01 $\mu$ F	250	Polyester
C308	5322 125 50049	9 pF	500	Trimmer
C309, 311, 322, 325	5322 121 40323	0.1 $\mu$ F	100	Polyester
C312, 313	5322 124 10005	3.3 $\mu$ F	15	Tantalum
C316, 317	5322 124 10153	22 $\mu$ F	15	Tantalum
C319, 321	5322 121 40233	0.68 $\mu$ F	100	Polyester
C401, 403, 407	5322 122 70055	4700 pF	350	Feed through
C409, 412, 418	5322 122 70055	4700 pF	350	Feed through
C421, 424	5322 122 70055	4700 pF	350	Feed through
C402, 404, 406	5322 121 40057	0.068 $\mu$ F	250	Plate
C408	5322 125 50045	22 pF	50	Trimmer

<i>Number</i>	<i>Code number</i>	<i>Value</i>	<i>Volts</i>	<i>Description</i>
C177, 179, 182	5322 121 40057	0.068 $\mu$ F	100	Polyester
C178, 181	5322 124 10108	47 $\mu$ F	35	Tantalum
C301	5322 121 40055	0.047 $\mu$ F	250	Polyester
C410, 413, 419	5322 121 40057	0.068 $\mu$ F	250	Plate
C422, 423	5322 121 40057	0.068 $\mu$ F	250	Plate
C414, 417	4822 122 30027	1000 pF	30	Plate (cer)
C416	5322 125 50045	22 pF	50	Trimmer

**COILS, RELAYS, BEADS**

<i>Number</i>	<i>Code number</i>	<i>Qty.</i>	<i>Description</i>
L103, 104, 106, 107, 108, 112	5322 158 10052	6	Bead
RE101	5322 280 20028	1	Relay SZC7123

**SEMI-CONDUCTORS****Diodes**

AAZ13	5322 130 30231
BAV45	5322 130 34023
BAW30	5322 130 30568
BAX13	5322 130 40182
BAX16	4822 130 30273
BAY38	5322 130 40256

**Zener diodes**

BZY88/C3V3	5322 130 30392
BZY88/C6V2	5322 130 30286
BZY88/C6V8	5322 130 30079
BZY88/C8V2	5322 130 30285
BZY88/C9V1	5322 130 30294
BZY88/C12	5322 130 30346

**Transistors**

ASZ21	5322 130 40271
BC109	5322 130 40144
BF173	5322 130 40326
BFW11	5322 130 40408
BFY90	5322 130 40493
BSV81	5322 130 44041
BSX20	5322 130 40417
LSY39A	5322 130 40632
2N3563	5322 130 40204
508BSY	5322 130 40671

**Integrated circuit**

TAA 521	5322 209 80068
---------	----------------

Note: In /05 version the following changes are made

GR104 was BAW30 is BAY45

GR403, 407 was BAY38 is BAX13

TS307, 308 was BSY39A is BSX20

TS301, 302, 304, 306 was 508BSY is BSV81

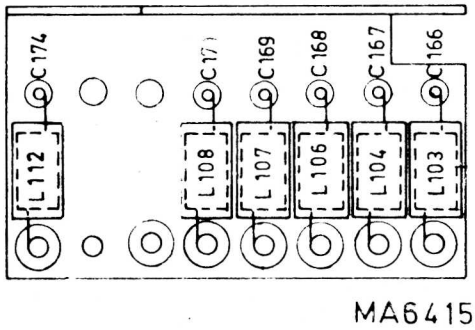

Fig. 19. Printed circuit Unit 7 (Supply filter)

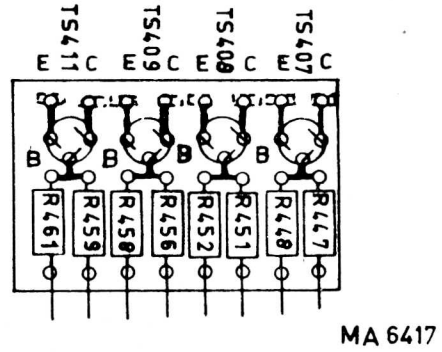

Fig. 20. Printed circuit Unit 8 (Final stage)

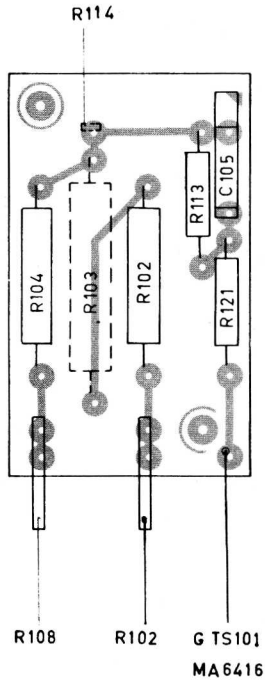

Fig. 21. Printed circuit Unit 9 (Gate circuit)

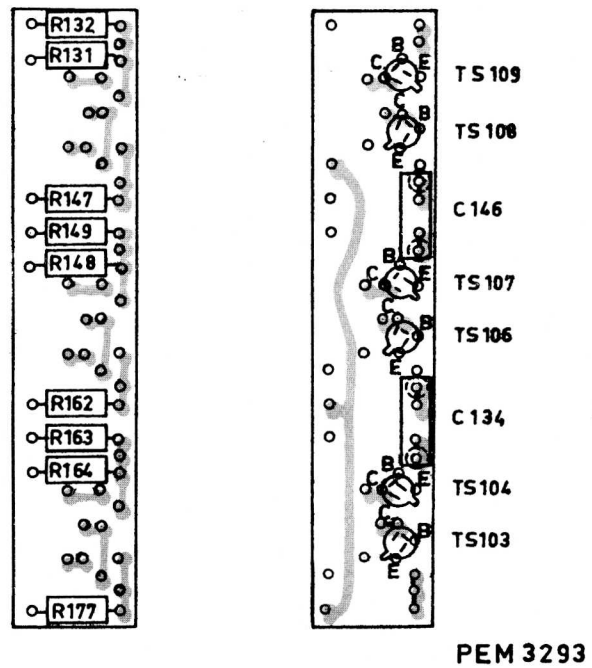

Fig. 22. Printed circuit Unit 10 (H.F. amplifier)

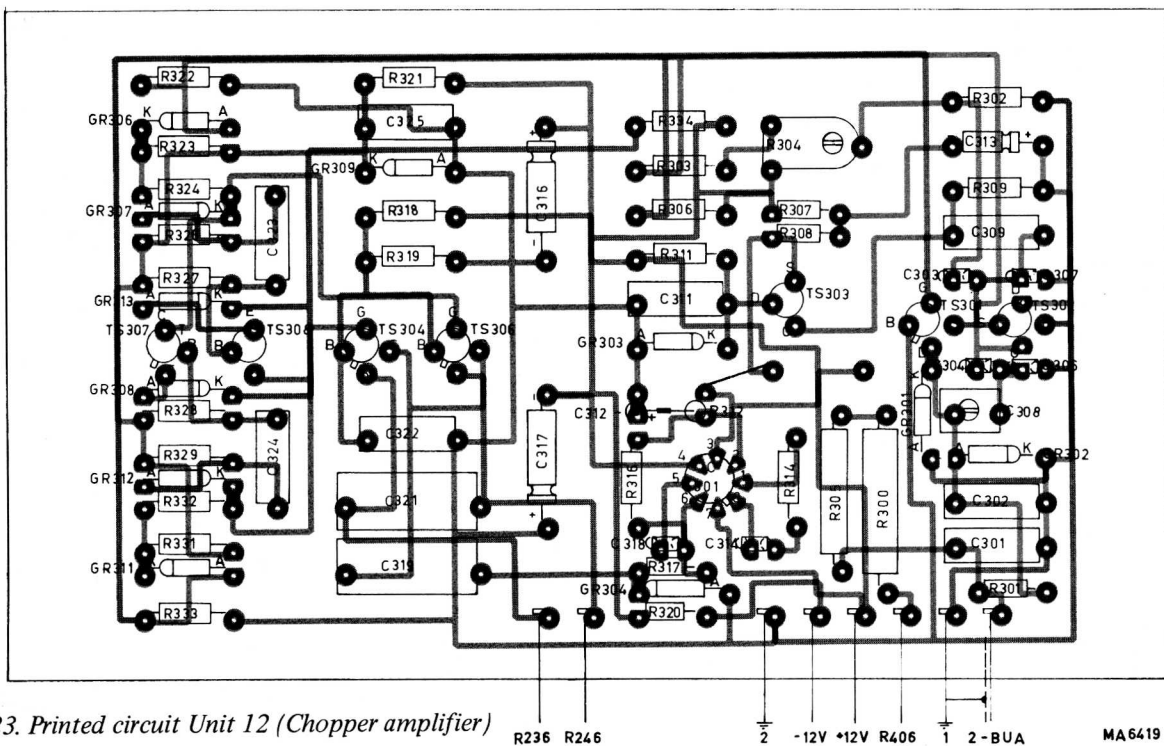

Fig. 23. Printed circuit Unit 12 (Chopper amplifier)



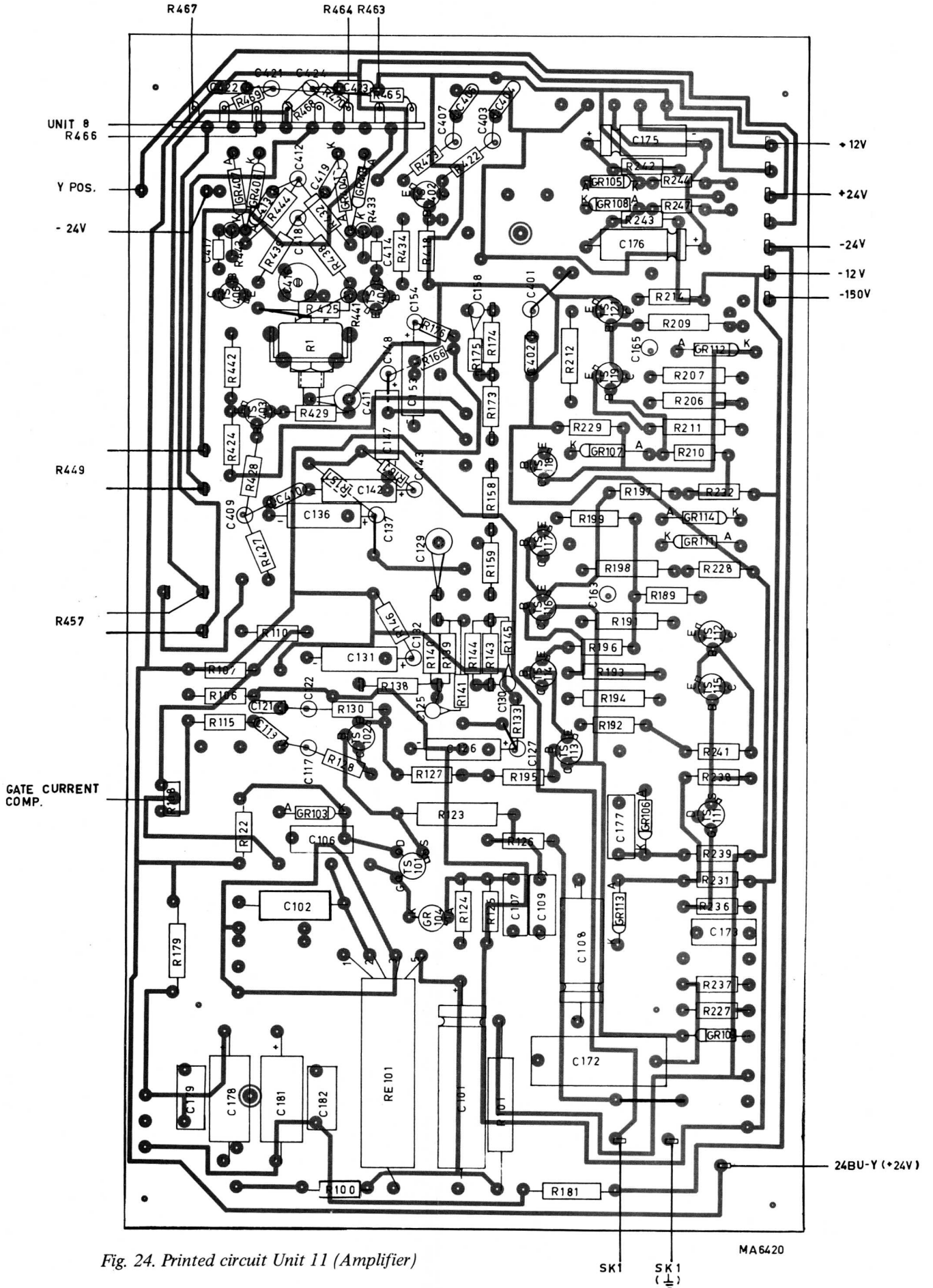

Fig. 24. Printed circuit Unit 11 (Amplifier)



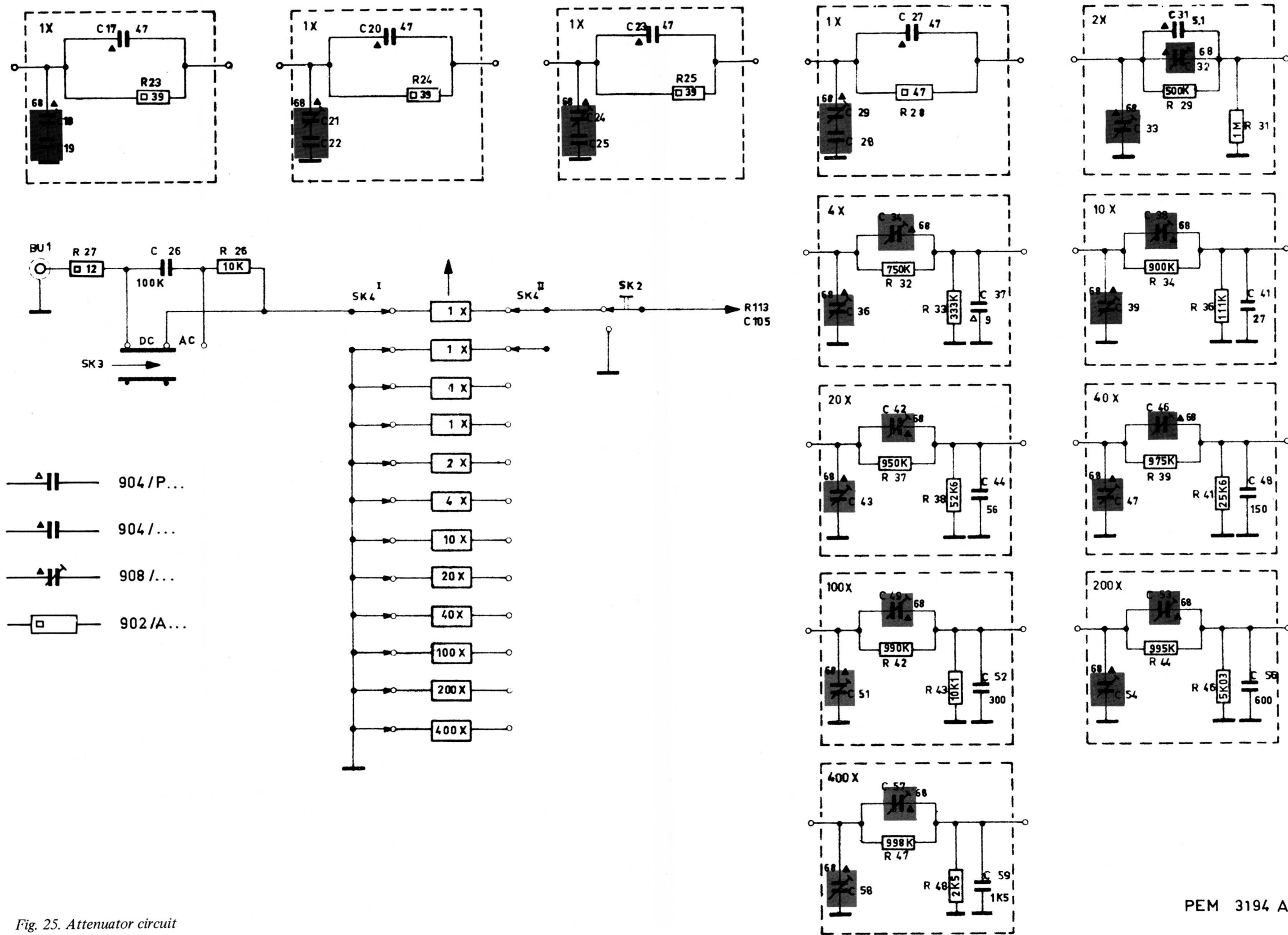

Fig. 25. Attenuator circuit

PEM 3194 A

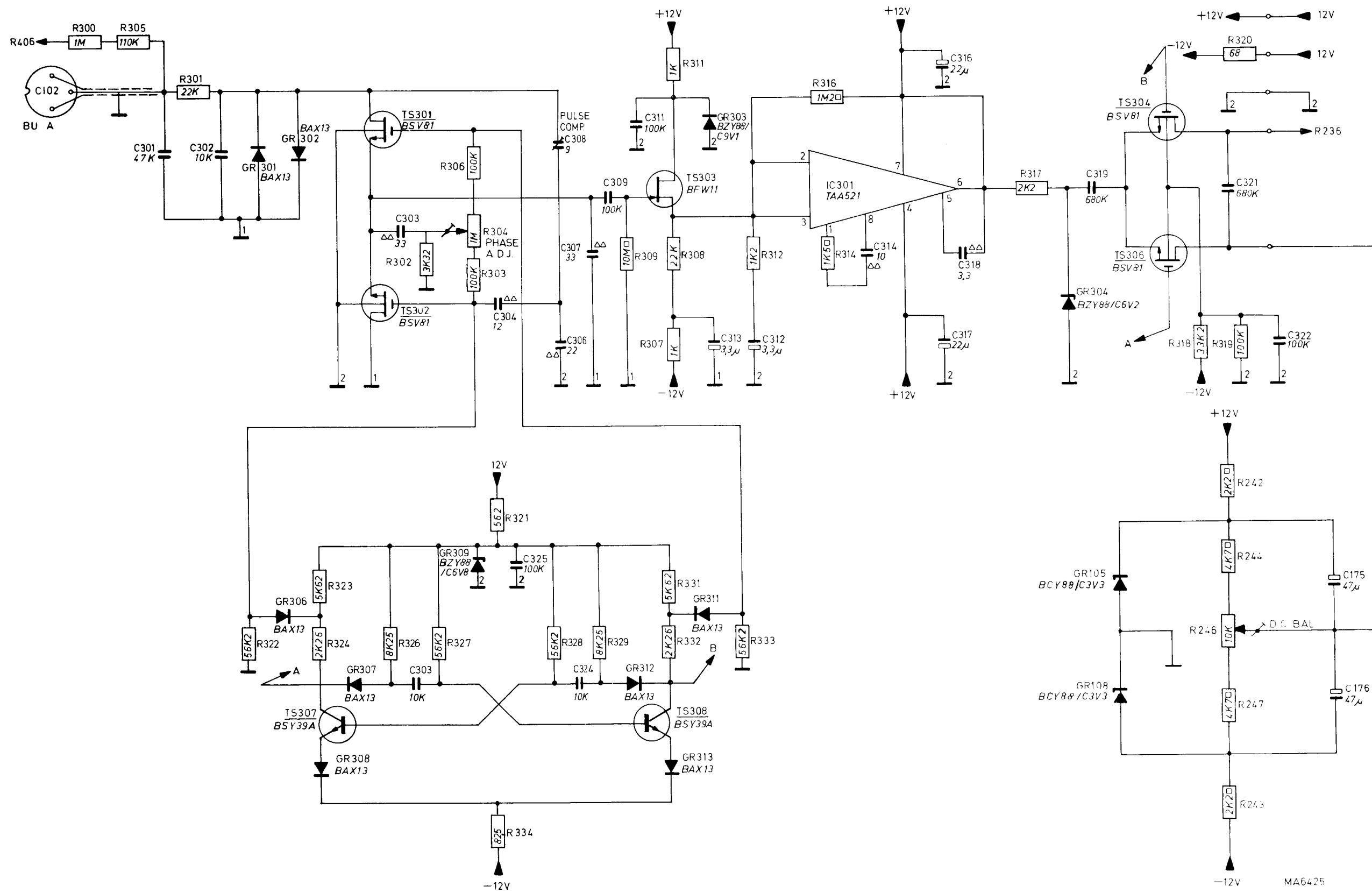
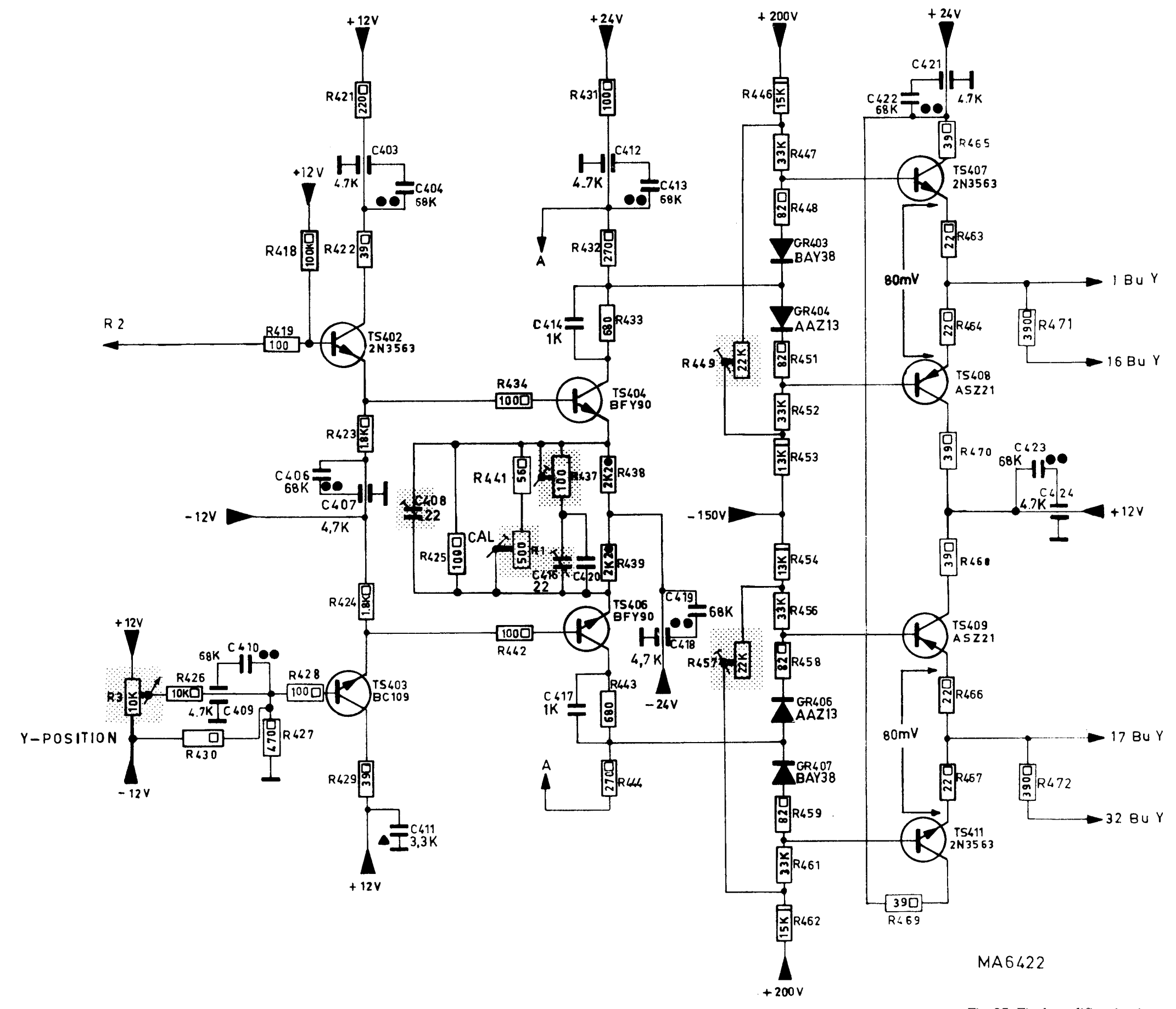
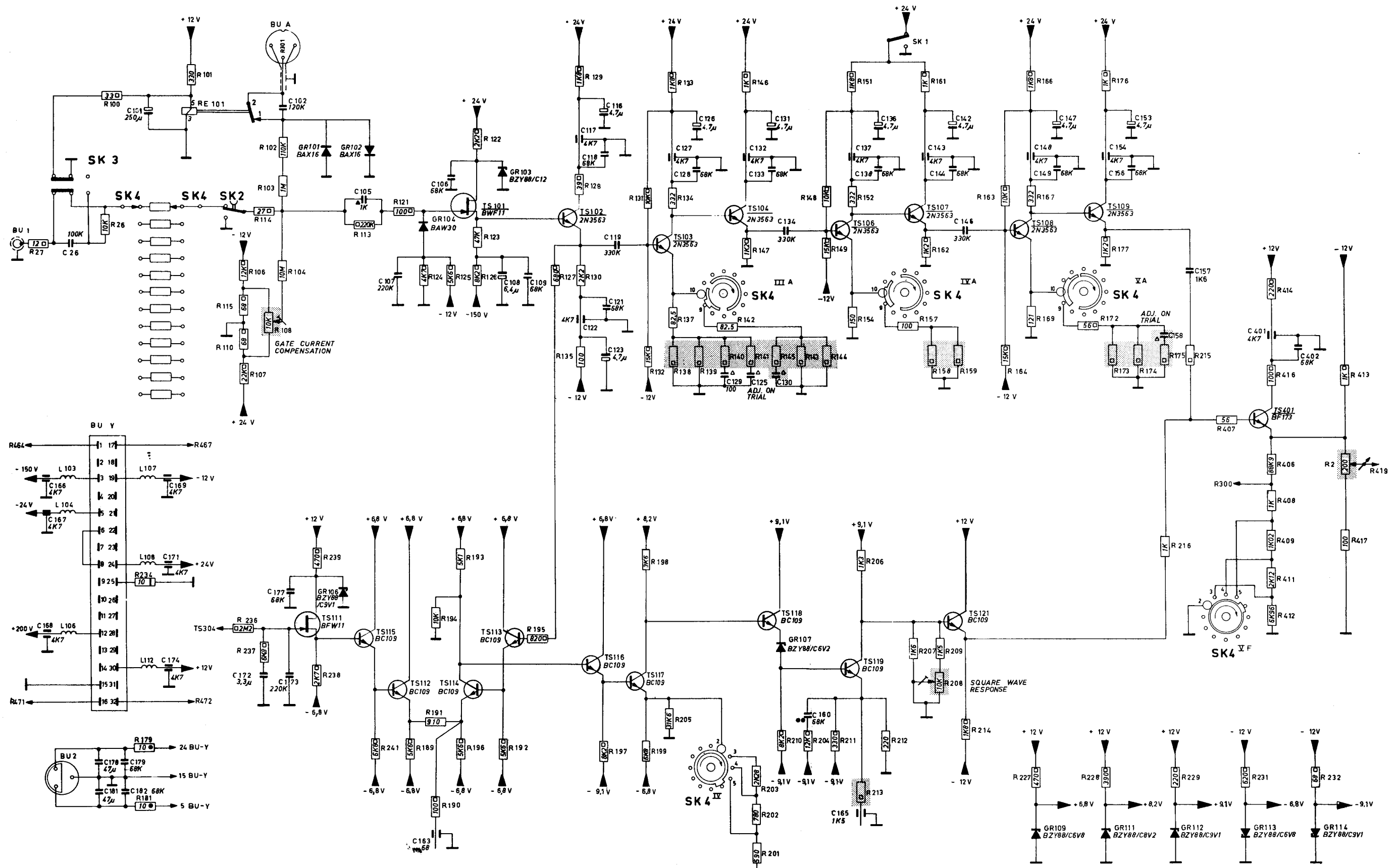

Fig. 26. Chopper amplifier circuit



MA6422

Fig. 27. Final amplifier circuit



MA 6430

Fig. 28. H.F. and L.F. amplifier circuit