

RADIOTRONICS

VOL. 24, No. 12

DECEMBER, 1959

Price: One Shilling

**AMALGAMATED WIRELESS VALVE COMPANY
PTY. LTD.**

Registered at the G.P.O., Sydney, for transmission by post as a periodical

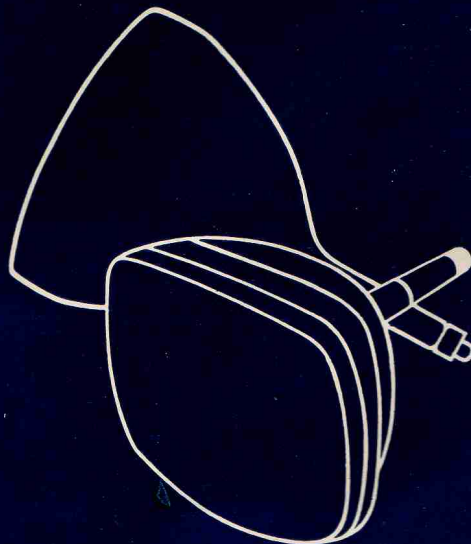
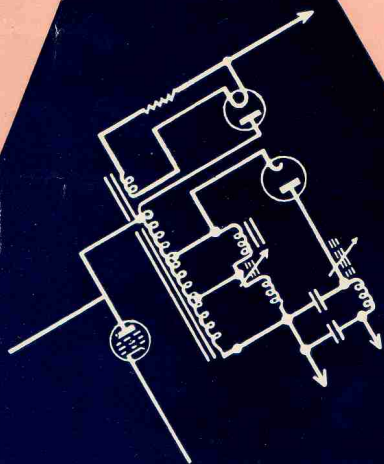

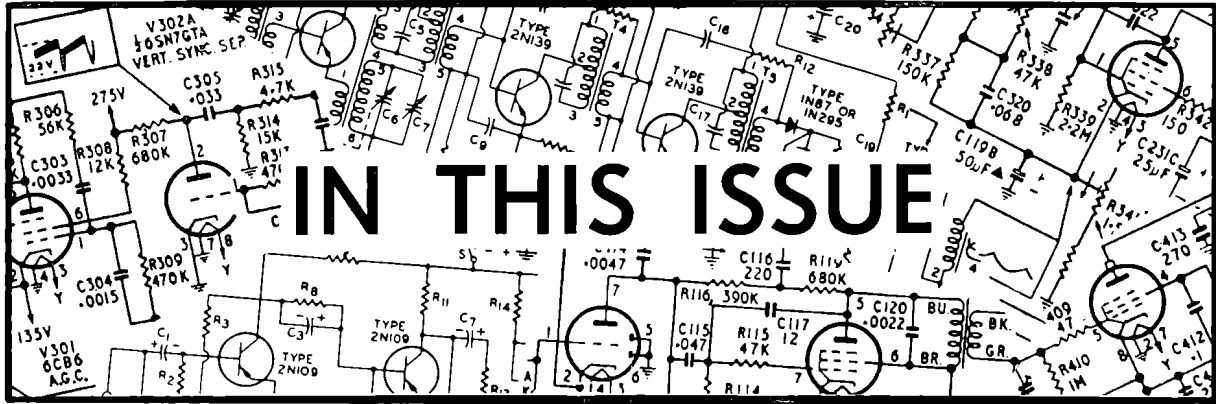

PARAMETRIC AMPLIFIERS 311

The parametric amplifier is built around a p-n junction semiconductor diode designed for use at high frequencies, and in which the capacitance across the junction depends on the voltage across it. This article explains how the diode is used in building very-low-noise receivers and other equipment.

FOR SSB SERVICE 321

This article describes an extremely stable, 5-band, cathode-driven linear amplifier for single-sideband service. This easily-constructed unit provides band-switched operation on the 80, 40, 20, 15 and 10-metre bands.

OFF THE BEATEN TRACK No. 5 — DISPLAY STORAGE TUBES 325

In this fifth article of the series, storage tubes of the directly-viewed type are described. Storage tubes of other kinds, such as charge-storage tubes, will be covered in future articles.

NEW RCA RELEASES 329

- 1J3, 1K3** Half-wave HV vacuum rectifiers.
- 7360** Beam deflection valve.
- 7536** Photoconductive cell.

CUMULATIVE INDEX Lift-out Supplement

In response to demand, the usual annual index is this year replaced by a cumulative index covering the years 1946-1959 inclusive.

Parametric

Amplifiers

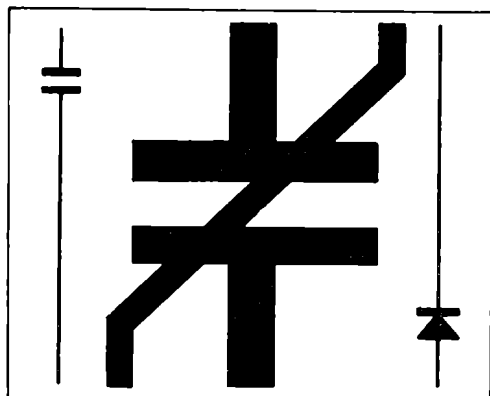

BY
B. J. SIMPSON

Introduction

We often view with pleasurable excitement new developments in the radio art, developments which open up new fields of endeavour, or provide better means of solving existing problems. Frequently, however, when the first excitement is over, and we look at the new idea more objectively, we find that the idea or application is by no means new, but that improved technology has turned an idea into practical possibility.

A typical case is the parametric amplifier, the basic principles of which were probably expounded by R. V. Hartley in 1936.¹ Parametric amplifiers, also known as variable-reactance and variable-capacitance amplifiers, achieve amplification by periodically varying a reactance in a resonant signal circuit. The name stems therefore from the variation of one of the circuit parameters. The parametric amplifier is therefore closely allied to magnetic and dielectric amplifiers, but it employs a different principle and should not be confused with them.

The present increased interest in the parametric amplifier is brought about by the need for amplifiers with very low noise figures, particularly at uhf and shf frequencies, coupled with the development of suitable variable capacitors. In 1948, A. van der Ziel² concluded that a parametric amplifier should exhibit very low noise because the absence of the thermionic valve would mean that there would be no shot-effect or other noise inseparable from the valve. In the ideal circuit he concluded that because the circuit contains only reactances, there would be no thermal agitation noise, since its magnitude depends among other factors on the resistive component of the impedance across which the noise is developed. In the practical circuit of course some resistance in the circuits is unavoidable.

Supplementing van der Ziel's conclusions regarding low noise possibilities, H. C. Torrey and C. A. Whitmer³ had observed negative conversion conductances in crystal diode mixers, and working with W. C. Hahn, showed that the negative conductances arose from the voltage dependence of the capacitance across the junction of a crystal diode. They thus demonstrated how a parametric amplifier could be built to operate at microwave frequencies using a crystal diode as the variable reactance.

The Amplification Mechanism

Before the parametric amplifier can be discussed in further detail, it is necessary to understand the mechanism by which a variable capacitor can be made to amplify a signal. For the purposes of explanation let us consider a simple resonant circuit as shown in Fig. 1 (a), in which the spacing between the capacitor plates (and hence the capacitance) can be varied mechanically, as for example by a motor-driven stepped cam. The mechanical analogy is a useful one, as will be seen later.

Now let it be assumed further that the sinusoidal signal of Fig. 1 (b) is to be amplified in the circuit. We now arrange the speed and synchronism of the cam such that when the signal reaches point A, and the charge on the capacitor reaches a maximum, the separation between the capacitor plates is suddenly increased by a step on the cam. Separation and closure of the capacitor plates is represented by the stepped diagram of Fig. 1 (c).

When the capacitor plates are pulled apart, the voltage across them will increase, because the voltage across a capacitor is equivalent to the charge in coulombs divided by the capacitance, i.e.,

$$Q = CE, \text{ or } E = \frac{Q}{C}$$

When C becomes smaller, and Q of course remains constant, E increases, and the higher voltage

¹ "Bell System Technical Journal", July, 1936.

² "Journal of Applied Physics", November, 1948.

³ "Crystal Rectifiers", McGraw-Hill, 1948.

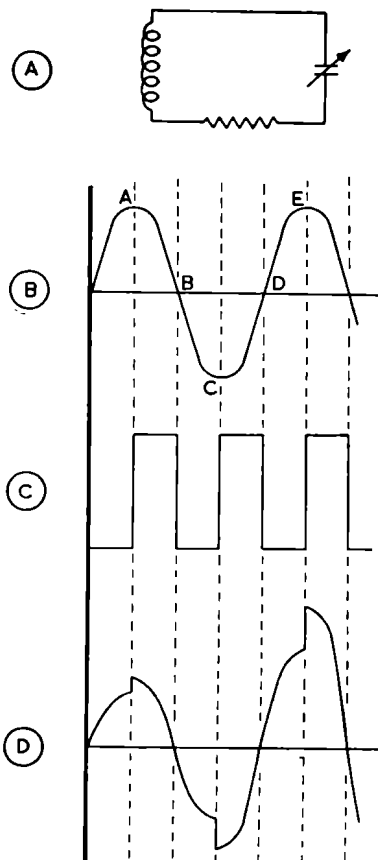

FIG. 1

with the same charge represents an increase in power in the circuit.

The increased power is the result of work done in separating the charged plates. The mechanical energy needed to increase the separation of the two plates and overcome the electric field between them appears therefore as an increase of the electrical energy stored in the capacitor, and is represented by the sudden increase in signal voltage shown in Fig. 1 (d). It is obvious that for maximum power gain the increased separation of the capacitor plates should be timed to occur at the signal maxima, i.e., at points A, C, E etc. of Fig. 1 (b).

There remains however the problem of restoring the capacitor plates to the original position ready for the next maximum, when the separation can again be increased. The closure of the plates must be achieved in such a way that the energy gained by separating them is not lost in the action of restoring the plates to the original position. The logical time to do this is when the charge on the capacitor is zero, i.e., at points B, D, etc. With a zero charge between the plates, no field is present, and no force is required to restore the plates to their original position.

The process of building up power in the circuit is illustrated by Fig. 1 (d). This process requires more force at each successive step to separate the plates, because the magnitude of the peak charge is larger each time. Assuming infinite force driving the capacitor plates, the process would build up indefinitely, taking more and more power from the driving mechanism. With finite driving powers however, the build-up progresses until the energy added at each peak equals the maximum energy available from the source. In practice a voltage-variable semiconductor capacitor is used instead of a mechanical device, and is controlled by the application of a signal of appropriate frequency.

Pump Frequency

The rate at which the capacitor plates are varied is known as the "pump" frequency. It may be assumed from what has already been said that the frequency of the "pump" or drive signal applied to the capacitor plates should be twice

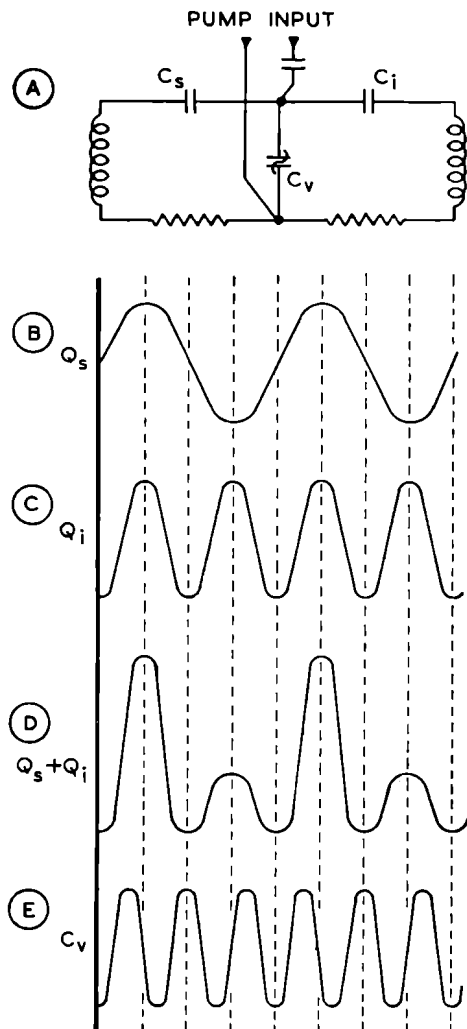

FIG. 2

the signal frequency, and that exact phasing is necessary. In the simple circuit of Fig. 1 (a), this is true, particularly if maximum efficiency is required. With the simple circuit, a departure from a pump frequency of twice the signal frequency will result in a beat effect as correct phasing is achieved and then lost again.

A second effect is also found, an image or "idler" frequency, equal to the pump frequency minus the signal frequency. This idler signal is as strong as the signal being amplified, and cannot be suppressed without losing the required amplification of the signal. It should be noted that the employment of a pump frequency of twice the signal frequency is a special case of the idler frequency, in which the idler frequency is equal to the signal frequency and is indistinguishable from it, i.e., it becomes a "wanted" signal.

The foregoing remarks apply to the simple circuit of Fig. 1 (a). There are cases where it is required to pump the circuit at a frequency other than twice the signal frequency, or to take the output at a frequency other than the signal frequency, as for example in a frequency converter. A comparatively simple circuit elaboration enables this to be done. The circuit is shown in Fig. 2 (a), and it will be seen that the modification consists of adding a second resonant circuit using the common variable capacitor, C_v , and tuned to the idler frequency. Capacitors C_s and C_i are in the portions of the circuit tuned to the signal and idler frequencies respectively. A third resonant circuit is of course involved in the application of the pump signal.

In this circuit the signal frequency section has a circulating current which contributes a charge Q_s to C_v , shown at Fig. 2 (b), and the idler frequency section has a circulating current which contributes a charge Q_i to C_v , shown at Fig. 2 (c). The total charge across the capacitor is $Q_s + Q_i$, and is shown at Fig. 2 (d). Fig. 2 (e) shows the variation of the coupling capacitor C_v at the pump frequency, equal to the sum of the signal and idler frequencies.

An examination of the curves of Fig. 2 (d) and (e) shows that the pump frequency is equal to the sum of the signal and idler frequencies, energy (though not always the maximum) is added to the system when the charge $Q_s + Q_i$ is at or near maximum and is extracted when the charge is at or near zero. It follows therefore that more energy is added to the circuit than is taken from it, with resultant power gain.

The role of the idling circuit has been well described as that of "distorting" the charge on C_v so that energy can be added by the pump. Pump energy added to the system is divided between the signal and idler circuits, so that an amplifier output at either the signal or the idler frequency can be obtained. The arrangement of a frequency converter will now be apparent.

From the foregoing it will be seen also that frequency converters can be designed either to convert the signal frequency to a higher frequency (up-converter) or to convert it to a lower frequency (down-converter). This point is reverted to later when amplifier circuit arrangements are being discussed.

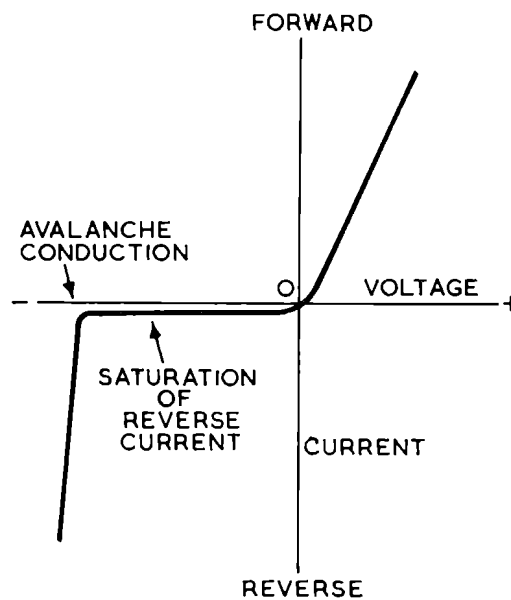

FIG. 3

The Diode Capacitor

It is obvious that mechanical variation of capacitance cannot be accomplished at microwave frequencies, and in practice a voltage-variable semiconductor capacitor is used. The capacitance of this component varies with applied voltage, and the applied voltage is the pump frequency signal derived from an auxiliary oscillator.

Crystal diodes have been used for a long time as voltage-variable capacitors to obtain conversion gain in microwave mixer circuits. The main point about such a device for use in a parametric amplifier is that it must be designed to minimise high frequency losses. One of the ways in which this is done is to reduce the size very considerably. In other respects the crystal diode is very suitable: appreciable variation of capacitance with applied voltage is obtained, and its small size is useful in microwave work.

Silicon diodes are generally used because of their good performance at elevated temperatures, sharper breakdown characteristics, and the fact that their lower saturation current allows larger voltage swings without running into conduction, with its attendant losses and noise. Diffused junctions are used, etched to a mesa* pattern to reduce size and capacitance. The capacitance of a diffused junction is determined in operation by

* See Appendix.

the thickness of the depletion layer, which is in turn dependent on applied voltage—hence the variation of capacitance.

Essentially of course, the diode, whether a point-contact type or a diffused junction, is a rectifier, with a current versus voltage characteristic as shown in Fig. 3. It will be seen that this diagram is drawn so as to emphasise the reverse-voltage characteristic of the diode. Compare the diagram with that in "Zener Diodes", Fig. 1, "Radiotronics" Vol. 24, No. 10. The diode conducts freely in the forward voltage region, but when the applied voltage is reversed, the reverse current saturates at a comparatively low voltage, and remains constant with increasing reverse voltage until the "avalanche" point is reached.

As explained in the article mentioned above, the reverse current rises extremely rapidly when the critical or avalanche point is reached. When considering the phenomena of voltage-dependent capacitors, the main interest lies not in this point, but in the region of saturated reverse current. Within this region the conduction current is independent of voltage, and the diode acts like a very high impedance to low-frequency applied voltages. As the applied frequency is increased, the impedance behaves like a capacitance in series with a resistance, which is the base resistance of the diode. The capacitive component can be made to vary with the applied voltage.

The minimum capacitance of the diode is fixed by the reverse breakdown voltage. Breakdown is not necessarily destructive, but has the effect of clamping the voltage excursion and therefore the capacitance variation. In practice breakdown would be avoided as it introduces noise and losses. At zero bias the capacitance variation of a diode with temperature is noticeable, and is quite pronounced at forward applied voltages. In the re-

verse-biased condition however, where the diode is used in this application, the capacitance is very insensitive to temperature.

The important characteristics of a diode for use in parametric amplifiers can be summarised under three headings, capacitance variation, minimum capacitance, and base resistance. The capacitance variation with applied voltage should be as wide as possible, whilst at the same time, a small minimum capacitance is required to allow appreciable voltage to be realised across the capacitor at the operating frequencies. The base resistance of the diode is effectively in series with the capacitance, and should therefore be as low as possible in order to maintain a high Q in the diode.

The minimum capacitance and base resistance are of course largely inseparable, tending to vary inversely with respect to each other. In practice therefore it is found that the Q tends to remain constant. A "figure of merit" is used qualitatively in relation to diodes, and is the cutoff frequency as determined by the expression $f_c = 1/(2\pi R_s C_{min})$, where R_s is the base or series resistance and C_{min} the minimum capacitance. The cutoff frequency is defined as the frequency at which the Q of the diode becomes unity. It is interesting to compare this figure of merit with that applied to transistors.

Amplifier Circuits

It was seen earlier, in the discussion of the amplification mechanism, that the simplest parametric amplifier consists of three tuned circuits mutually coupled through the variable-reactance diode. Such a circuit is shown in Fig. 4, where the three separate tuned circuits are resonant at the signal frequency, pump frequency and idler frequency, f_s , f_p and f_i respectively. It is important to remember that according to the operating frequencies, the three tuned circuits may be built up of separate inductors and capacitors, or may be coaxial line sections, or may even be three independent modes in a resonant cavity.

In the case of the simple circuit shown in Fig. 4, the input and output circuits are effectively in parallel, and the amplifier is a two-terminal device. This means that the amplifier suffers from the disadvantage that noise originating in the output circuit can reach the input circuit, where it can be amplified, and so on. This may happen for example where the low-noise parametric amplifier is followed by further amplification with poorer noise performance.

To some extent this disadvantage can be overcome by using a circulator* to couple the signal input, parametric amplifier, and subsequent stages, and to achieve a degree of directional coupling between them. A typical arrangement of this kind is shown in Fig. 5, where signals travel counter-

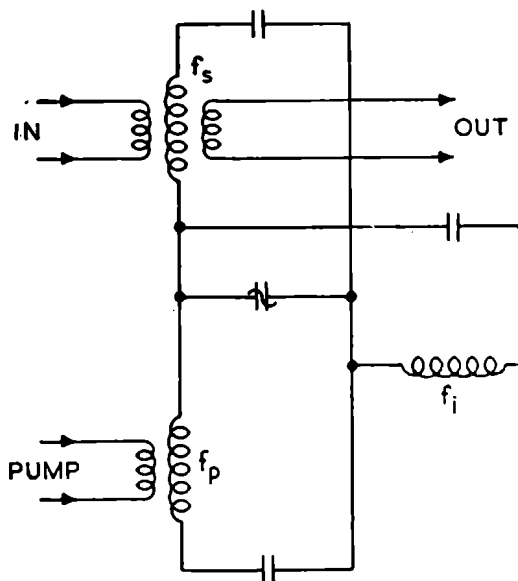

FIG. 4

* See Appendix.

clockwise. The input signal travels counter-clockwise through one quadrant of the circulator until it reaches the parametric amplifier. The output of the amplifier then passes through the next quadrant to the subsequent stages. Noise generated in the following circuit then travels through the third quadrant to a resistive termination. This arrangement therefore isolates the input and output circuits of the parametric amplifier, preventing noise feedback. The circulator however is bulky, and can itself contribute noise.

These considerations led to the development of the four-terminal parametric amplifier, in its several forms. Before going on to this development, it is necessary to recall that a frequency-converting parametric amplifier can be either an up-converter or a down-converter. It has been shown that the noise figure of the amplifier depends on the ratio between the signal and idler frequencies, that is, the smaller the ratio the lower the noise figure.¹⁰ These facts led to an examination of up-converter amplifiers in which the pump frequency is high in relation to the signal frequency, and in which isolation of the output from the input is arranged by taking the output at the idler frequency.

The system was examined by G. F. Hermann, M. Uenohara and A. Uhlir Jr.,⁴ and by B. Salzburg and E. W. Sard,⁵ among others. It was shown that this arrangement produced an amplifier with a very low noise figure.

But whilst up-converters had good characteristics for lower frequencies, at higher frequencies difficulties arose in finding suitable oscillators to generate the pump frequency voltage and in de-

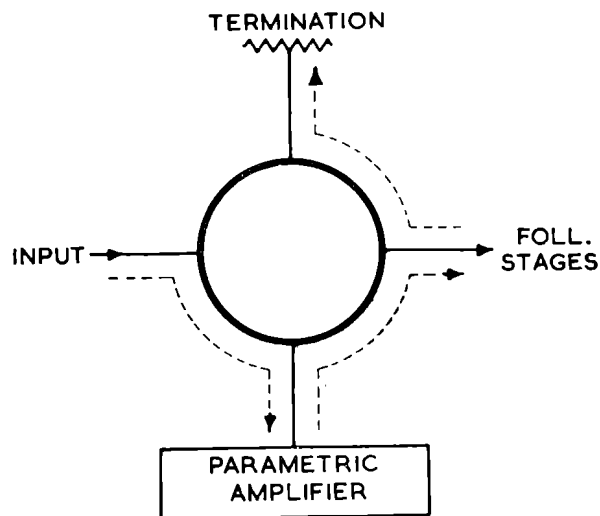

FIG. 5

signing circuits to handle the output signal. This led S. Bloom and K. K. Chang to investigate amplifiers pumped at a frequency lower than the signal frequency.^{6,7}

In the mode of operation set up by Bloom and Chang, a low pump frequency is used, but the non-linearity of the variable-reactance diode is used to generate a harmonic of the pump frequency. This harmonic of the pump frequency, usually the second or third harmonic, then becomes the effective pump frequency.

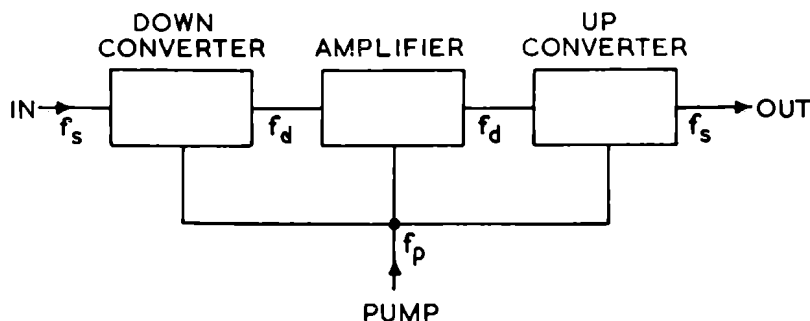

FIG. 6

K. K. Chang has also devised a three-stage four-terminal parametric amplifier⁸ in which, although the input and output frequencies are equal, the need for a circulator is eliminated. This amplifier is shown in Fig. 6, and is a double-conversion arrangement. A down-converter, intermediate-frequency amplifier, and up-converter are pumped from a common source, which in practice uses a frequency lower than the signal frequency.

The signal is down-converted in the first stage, producing a low signal frequency to idler frequency ratio in the second stage, a condition favourable to low-noise operation. After amplification, an up-converter restores the signal to the original frequency. If the pump power to each stage were the same, the network would be reciprocal. It is possible however to arrange for the pump power applied to the three stages to be in a proportion which produces a 50 db isolation between input and output.

A simple but interesting practical amplifier using a resonant cavity and operating in the 144 Mc amateur band is shown in Fig. 7. This amplifier was built by F. S. Harris W1FZJ.⁹ An amplification of 10 db is reported, with a low noise figure. The author states that he has used pump frequencies of not only twice the signal frequency, but also three times and five times the frequency, with good results.

⁴ "Proc. I.R.E.", June, 1958.

⁵ Idem.

⁶ "Journal of Applied Physics", March, 1958

⁷ "Proc. I.R.E.", July, 1958.

⁸ "Proc. I.R.E.", January, 1959.

⁹ "CQ", November, 1958.

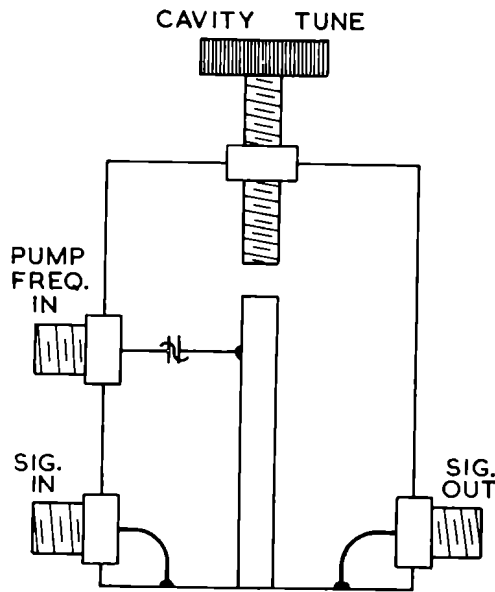

FIG. 7

The regenerative nature of the parametric amplifier means that it is subject to bandwidth limitations. The position has been summarised by L. S. Nergaard,¹⁰ who points out that with a passive network of specified bandwidth, the gain obtainable in the circuit by regeneration is proportional to the reduction in bandwidth that can be tolerated.

The search for a broad-band parametric amplifier has led to the examination of circuits with wide passive bandwidths, including the low-pass filter. The theory of converting a low-pass filter into a travelling-wave parametric amplifier has been stated by P. K. Tien,¹¹ and an amplifier based on these principles has been built and described by R. S. Engelbrecht.¹² But how is this done? The low-pass filter is developed into a travelling-wave parametric amplifier by replacing the usual shunt capacitors with variable-reactance diodes, as shown in Fig. 8.

The signal and pump frequencies are introduced at one end of the network, and the signal, idler and pump frequencies are present at the other end. Selection of the required frequency at the output follows conventional practice. The "output" end of the network is terminated with a "half-section" inductor and a resistor of a value determined in the usual way from the values of the lumped reactances. The termination prevents reflections, so that there is no feedback and the device is a four-terminal one.

Amplification is achieved in the travelling-wave amplifier just described when two requirements are met; firstly the three fre-

quencies involved must lie within the pass-band of the network; and secondly the upper sideband, that is the sum of the signal and pump frequencies, must be in the stop-band.

A further development of the travelling-wave parametric amplifier is shown in Fig. 9, in which two balanced assemblies are used. Each assembly is basically similar to the arrangement of Fig. 8 previously discussed. A typical 4-stage amplifier constructed on these lines gave a 10 db gain with a 100 Mc bandwidth on a centre frequency of 400 Mc, with a noise figure of 3.5 db. A 16-stage printed-circuit amplifier¹³ gave an 8 to 10 db gain over a 200 Mc bandwidth around 650 Mc.

Amplifier Performance Summary

The importance of the parametric amplifier rests in its low-noise performance. In conventional receivers for use at very-high and ultra-high frequencies, noise generated in the receiver itself is generally a large portion of the total noise in the system.* In fact, it is frequently the limiting factor on receiver performance and sensitivity. The search for lower-noise receiver arrangements is continuous, and it is here that the parametric amplifier is expected to yield superior performance. To this expectation is added the possibility of wide latitude in selection of pump frequency, particularly the use of pump frequencies lower than the signal frequency, and the practicability of wide-band amplifiers; without these possibilities the use of the amplifier would be very restricted.

Probably the best way to show the performance characteristics of the amplifier in its various forms is to refer to Table 1, in which the more important characteristics of representative parametric amplifiers are listed. These figures speak for themselves, and those for the up-converter configuration are of particular interest.

Fig. 10 shows a comparison between the parametric amplifiers and other amplifiers, with noise figures quoted in equivalent noise temperature in order to present an overall picture. Also included

¹⁰ "RCA Review", March, 1959.

¹¹ "Journal of Applied Physics", September, 1958.

¹² "Proc. I.R.E.", September, 1958.

¹³ Engelbrecht, Solid-State Circuits Conference, Philadelphia, 1959.

* See Appendix.

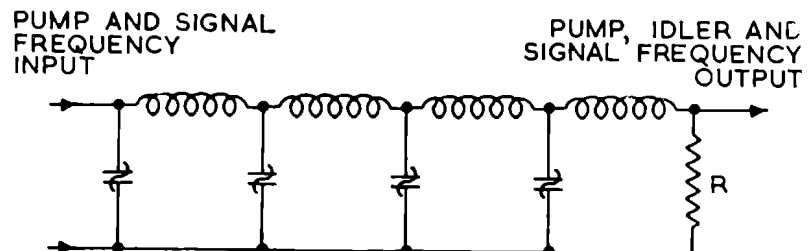

FIG. 8

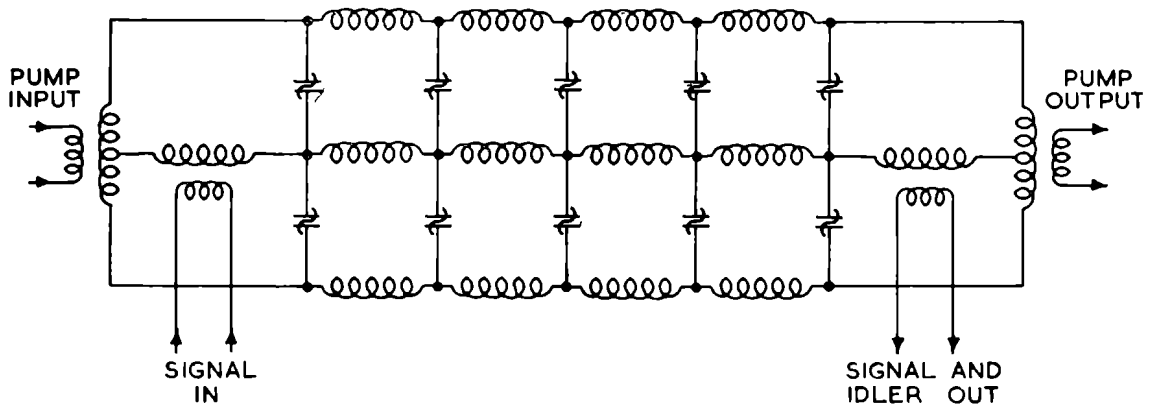

FIG. 9

in the figure are galactic noises and terrestrial (atmospheric) noise. Not marked on the figure is the equivalent noise temperature on the earth, which is about 300°K. For further data on equivalent noise temperature, see the Appendix.

For the purpose of making a more complete comparison, the noise figures of a few commonly-met triode, commercial and low-noise travelling-wave tubes, and conventional crystal mixers have been included. It must be stressed that the figures ascribed to the various devices are typical only, and do not necessarily indicate either average or optimum performance. In the case of the parametric amplifiers shown, improved noise performance could doubtless be achieved by employing refrigeration as in the case of the masers.

In studying Fig. 10, it should be remembered that if the receiver aerial used is capable of receiving terrestrial noise, then an amplifier with a noise performance better than the equivalent noise temperature of the earth will be adequate. However, if the aerial does not receive terrestrial noise, being for example elevated at an acute angle,

then the amplifier will be required to have an equivalent noise temperature lower than that of the galactic noise if optimum performance is to be realised.

The low-noise characteristics of the parametric amplifier have opened the door to the design of receivers having noise performances superior to those previously obtainable, except of course for the masers which are already in use in some radio telescope applications. Furthermore the stability of the device indicates that the superior performance may be more capable of being retained over long periods of time. One side product of the superior receivers possible now will be a shift of emphasis onto aerial research, with a view to providing designs with lower equivalent noise temperatures to complement the receivers.

APPENDIX

1. MESA CONSTRUCTION

"Mesa" construction is widely used at present for the manufacture of semiconductors for operation at high frequencies. In this method a junction is formed in the usual way. The junction is then etched in from the outside of the "sandwich" until only a very small area remains. There then remains the un-etched bottom layer of semiconductor material, and the much smaller etched top layer forming a junction in the centre of the bottom layer. A cross-sectional view of the device then looks like a flat-topped hill in the centre of a plain. The method of construction is named for its similarity to the mesas or flat-topped hills found in parts of North America.

2. NOISE AND NOISE TEMPERATURE

To appreciate noise and to analyse its effect, we have two fundamental but related concepts to consider. They are the noise figure and the effective noise temperature. Consider a network whose noise properties are to be evaluated, and think of it as a "black box", with two input and two output terminals.

TABLE I
PARAMETRIC AMPLIFIER
CHARACTERISTICS

AMP. TYPE	INPUT Mc	PUMP Mc	OUTPUT Mc	POWER GAIN db	BAND-WIDTH Mc	NOISE FACTOR db
CAVITY	2300	3500	2300	19	1.0	4.8
CAVITY	5850	11700	5850	18	8	3
COAXIAL	380	300	380	10	3.4	7
4-TERM.	214	150	214	8	0.25	2.5
UP-CONV	460	8915	9375	9		2.0
UP-CONV	1.0	20	21	10	0.1	0.4
TW AMP.	380	630	380	10-12	10-20	3.5

We can now state a well-known definition of noise figure as being the ratio of total available noise power at the output terminals (N_o) to that portion of the output noise power due to the matched source resistance (N_{os} , external to the network), the figures being taken at 290° Kelvin. In other words, we are describing in effect how much noise is added by the network. A temperature of 290°K is commonly used as a reference temperature since the factor KT used in noise formulae then becomes a convenient value.

The Kelvin or absolute scale of temperature is based on an absolute zero temperature equal to -273.16°C . To the physicist, the temperature of a body means in effect the degree of molecular agitation in that body. This molecular agitation is taking place in all substances, whether gas, liquid or solid, at all times, and at all temperatures. The degree of agitation however falls with temperature and at the value quoted, -273.16°C (or 0°K), molecular agitation ceases, and a further reduction in temperature is not possible. This then is the absolute zero of temperature. It follows that the temperature of 290°K quoted in the definition of noise figure is equal to $290 - 273.16 = 16.84^\circ\text{C}$.

The noise output of a body is also related to temperature, and the case of an over-heated resistor producing excessive noise is a familiar one. The noise is produced by the same agitation that

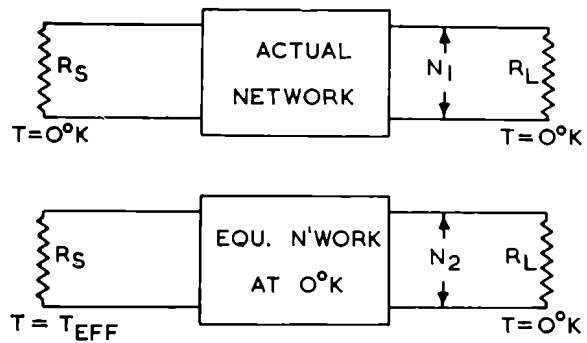

$$N_1 \equiv N_2 = N_{ON} = KBT_{EFF}$$

$$N_{OS} = KBT_0$$

$$F = \frac{N_o}{N_{OS}} = \frac{N_{OS} N_{ON}}{N_{OS}} = 1 + \frac{T_{EFF}}{T_0}$$

FIG. 11

has just been mentioned. From this point then it can correctly be assumed that at absolute zero temperature, the noise output of a body ceases. It is now an easy step to the conception of equivalent noise temperature, which is defined later.

Continuing the theme of noise figure, the available noise power from the source at T_o is KBT_o , where K is Boltzmann's constant, B is the network bandwidth, and T_o is 290°K —expressed in mathematical terms,

$$F = \frac{N_o}{N_{OS}} = 1 + \frac{N_{on}}{N_{os}}$$

where N_{on} and N_{os} are the noise power outputs due to the network and the source respectively.

It is now necessary to define effective noise temperature. As stated above, the noise output of a network is dependent on temperature, measured on an absolute scale. It follows therefore that the noise output of a network can be expressed in terms of the temperature to which a particular value of resistance must be raised to produce the same noise power output. The resistance has a value equal to that of the resistive component of the signal source impedance.

The effective noise temperature (T_{eff}) of our network is therefore the temperature to which the matching source resistance must be raised to produce a noise power output equal to that produced by the network.

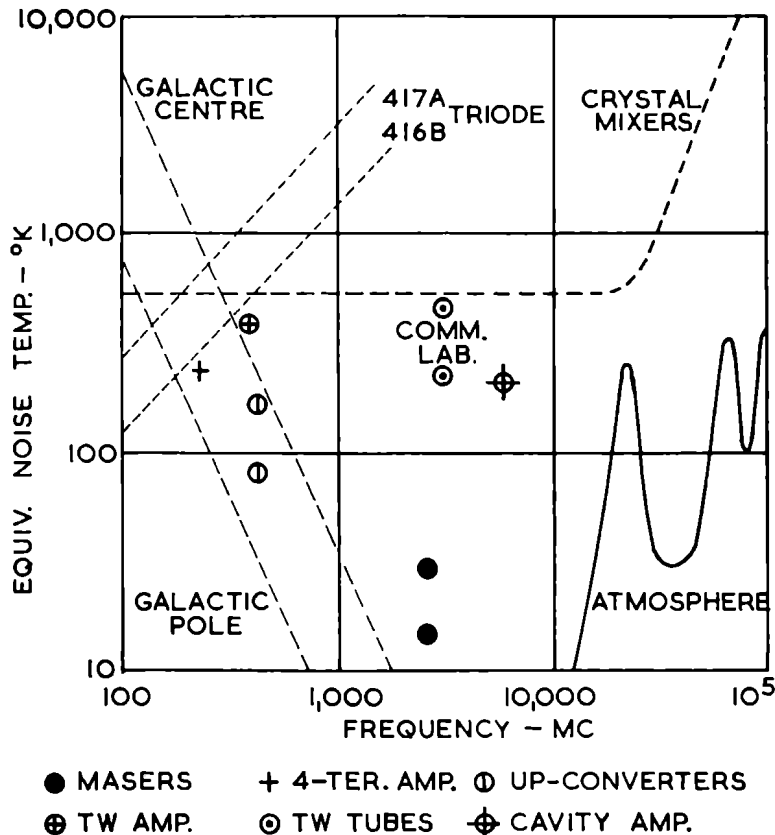

FIG. 10

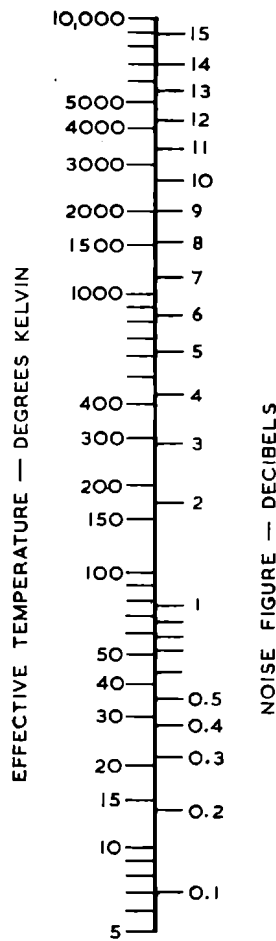

FIG. 12

This point is illustrated in Fig. 11. To clarify the definition given, what we actually do is divided into two steps. First we imagine a matched source impedance which is noiseless—noise output is N_1 , and is entirely due to the network. Then an electrically-identical but noiseless network is visualized, to which is connected the same matched source impedance. In this case however the source resistance is visualized as being heated from 0°K , to that point at which the noise output of the network (N_2) reaches the original value. The temperature of the source is then the effective noise temperature of the network. Noise figure can be expressed in terms of effective noise temperature

$$F = 1 + \frac{T_{\text{eff}}}{T_0}$$

The conception of equivalent noise temperature can be applied to any circuit or component of a system. It is a convenient measure to use as the effective noise temperatures of different parts of a system can be added to produce the effective noise temperature of the complete system. The relationship between the noise figure, expressed in decibels, and the effective noise temperature, expressed in degrees Kelvin, is shown in Fig. 12.

For further information on noise in systems using parametric amplifiers, see J. Sie and S. Wiesbaum, "Noise Figure of Receiver Systems using Parametric Amplifiers", IRE Convention Record 1959, Part 3.

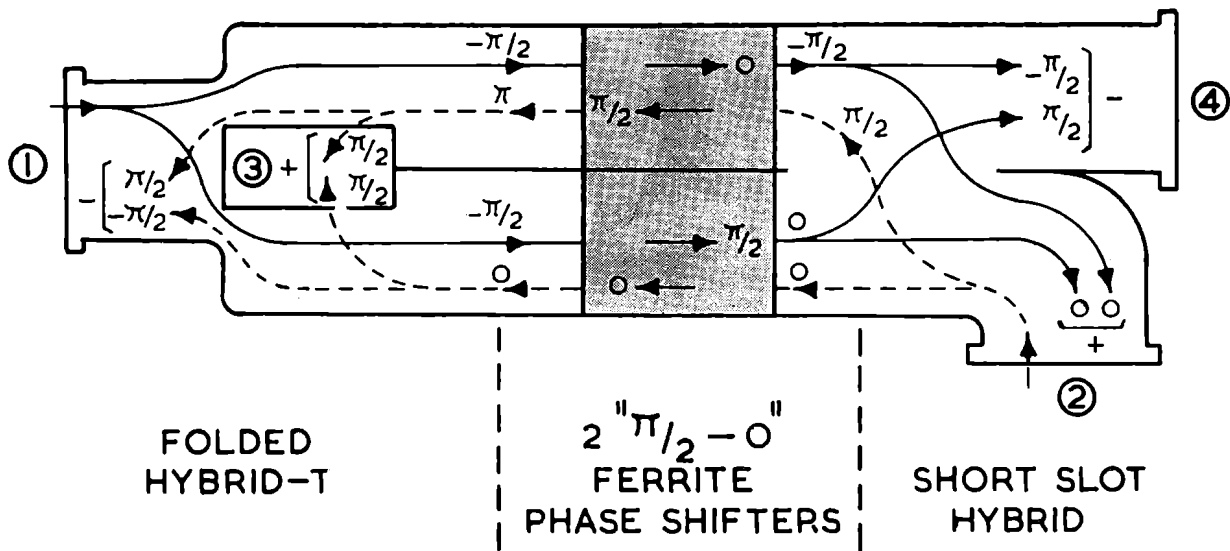

FIG. 13

Cathode-Driven Linear Amplifiers Using 7094 Beam Power Valve

By Claude E. Doner, W3FAL

This article features an extremely stable, five-band, cathode-driven linear amplifier for single-sideband service. Employing a single 7094 beam power valve, the amplifier provides bandswitched operation on 80-, 40-, 20-, 15-, and 10-metre bands and is easily constructed and adjusted. Under the conditions described by W3FAL, it delivers a peak envelope power of approximately 200 watts.

The high power gain, high efficiency, and low distortion necessary in a linear amplifier for single-sideband service can be provided most economically by a high-mu triode in a cathode-drive circuit. Because of its low input impedance, a cathode-driven amplifier does not require a tuned input circuit. And, because of the plate-cathode shielding provided by the grid, it usually does not require neutralization. Its low input impedance also makes it unnecessary to use "swamping" resistors to provide the constant driver loading required for good linearity. Although a cathode-driven amplifier requires more driving power than a grid-driven amplifier, most of the driving power appears as useful power in the output circuit, so that high overall efficiencies can be achieved. Additional economies can be achieved by the use of a triode which can be operated as a zero-bias class B amplifier.

Beam power valves or tetrodes which can be operated as high-mu triodes make excellent linear amplifiers. They are especially useful in cathode-drive circuits, because of the excellent shielding provided by the two grids.

The 7094 beam power valve has extremely good triode characteristics. It is particularly useful



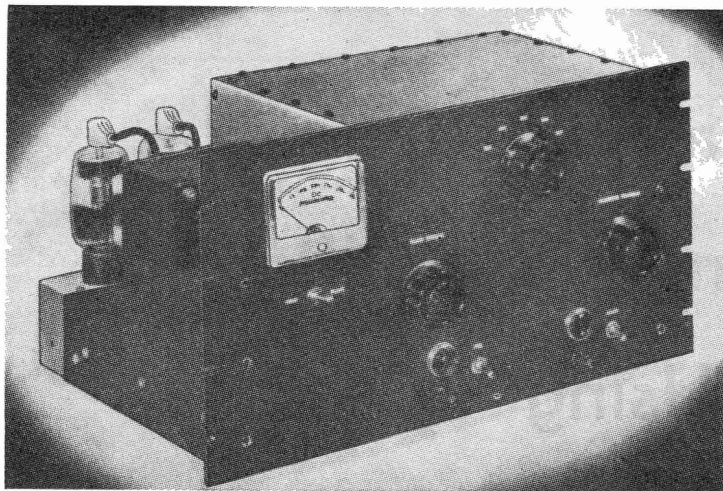

Fig. 1.—Front View of the Amplifier.

in cathode-drive service (1) because of its low plate-cathode capacitance and high perveance and (2) because it has an indirectly heated cathode and, therefore, does not require the use of filament chokes. As a class B linear amplifier in single-sideband service, a triode-connected 7094 with forced-air cooling can handle a peak-envelope-power input of 350 watts with only 1750 volts on the plate and zero bias on grids No. 1 and No. 2.

The circuit of the amplifier and power supply is shown in Fig. 3. For illustrations of the layout and mechanical construction, see the photographs.

Note that although grids No. 1 and No. 2 of the 7094 are connected in parallel for rf through C4, C9, C10, and C11, the dc return for the input circuit is connected to grid No. 2. The grids are not connected in parallel for dc except when the meter switch (S3) is in the plate-current position. This arrangement permits a single milliammeter connected in the ground side of the circuit to be used to measure either grid current or plate current without the hazard involved in switching the meter in and out of the high-voltage lead. It also minimizes the possibility of improper adjustments which would exist if the meter were used to measure only total cathode current.

A pi-network type, the output tank uses two tapped coils and a shorting-type bandswitching arrangement. L2, the coil for the 10- and 15-metre bands, is wound of 3/16-inch copper tubing and has 9 turns spaced 1/4-inch apart and an inside diameter of two inches. L3, the loading inductance for the 20-, 40-,

and 80-metre bands, consists of 23 turns of 12 gauge wire with an inside diameter of 2-1/2 inches.

The positions of the taps were chosen to provide an operating Q of approximately 12 on all bands for a 50-ohm load. The 10-metre tap is approximately four turns from the valve end of L2 and should be adjusted so that the plate-tuning capacitor (C15) is almost fully open when the circuit is resonant at the high-frequency end of the 10-metre band. The 15-metre tap is connected to the junction between the two coils. The 20- and 40-metre taps are 19 and 10 turns, respectively, from the output end of L3. In the 80-metre position of the bandswitch, a 500- μ mf fixed capacitor (C17) is connected in parallel with the loading capacitor (C18).

The meter is a single-scale, 0-300-milliamperere type. A lower range meter and external shunt were not considered necessary because the normal grid current (80 milliamperes) and plate current (200 milliamperes) can easily be read on the same scale. The 1000-ohm resistor (R1), connected between the positive side of the meter and ground, prevents high voltage from appearing at the cathode in the event of switch failure.

The power supply is a conventional full-wave type with choke-input filter. Type 3B28 gas rectifier valves were used instead of 866-A's to eliminate the "hash" produced by the mercury-

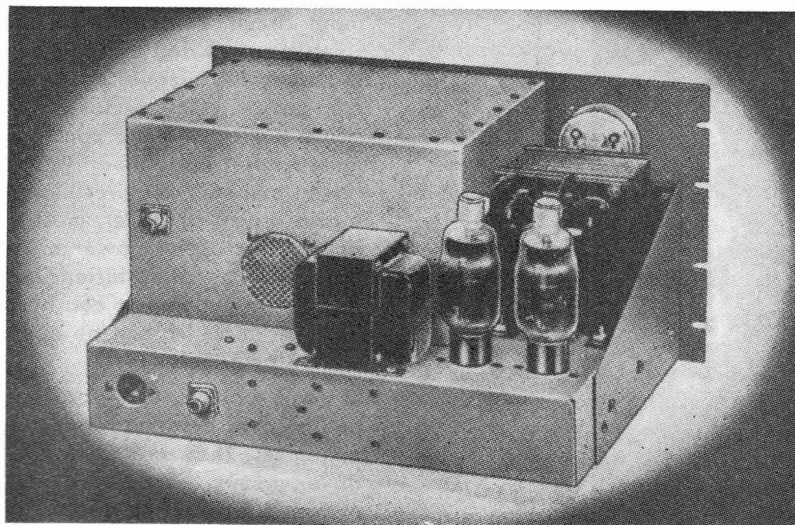

Fig. 2.—Rear View Showing RF Enclosure and Power Supply Components.

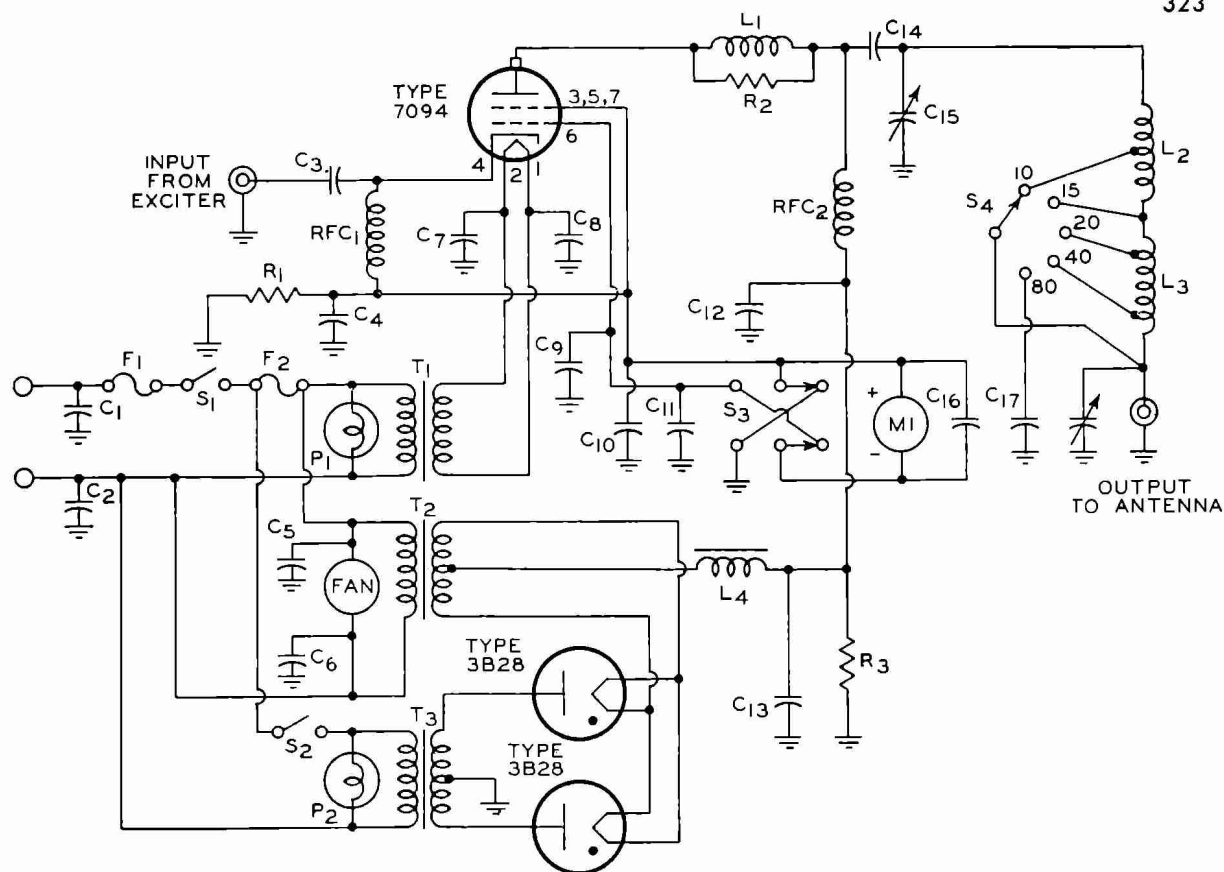

Fig. 3.—Diagram of the Linear Amplifier and Power Supply.

vapour types and to permit the amplifier to be operated on its side during tests and initial measurements. However, if you prefer, 866-A's may be used in place of the 3B28's without any changes in circuit values—provided the amplifier is always kept in a position such that the valves are vertical.

The plate-power switch (S2) is connected in series with the heater/filament-power switch (S1) in such a manner that power cannot be applied to the rectifier plates until the filaments of the 3B28's and the heater of the 7094 have been energized. If 866-A mercury-vapour rectifiers are used, it will be necessary to delay application of plate power for at least 30 seconds after filament power has been turned on.

Construction

Because of the simplicity of the circuit, it was possible to construct the amplifier and power supply on a 12- by 17- by 3-inch chassis and a 10½- by 19-inch rack panel. The chassis is bolted directly to the panel and reinforced with 6½- by 11-inch chassis mounting brackets. The 7094 and the plate-tank components are enclosed in a 7- by 12- by 9½-inch shield made of 18-gauge sheet aluminium. The front of this shield is mounted flush against the rack panel, and both are drilled for the shafts of the plate-tuning and loading capacitors and the bandswitch. Half-inch-wide

flanges on the top and bottom of the shield provide good rf contact to the chassis and the perforated aluminium cover plate.

The small fan mounted on the back wall of the enclosure provides forced-air cooling for the 7094. Serving as the air inlet is a circular area of closely-spaced ⅛-inch holes, 3 inches in diameter. The holes are drilled in the wall behind the fan.

To minimize rf losses, all connections between the plate-tank circuit components, the bandswitch,

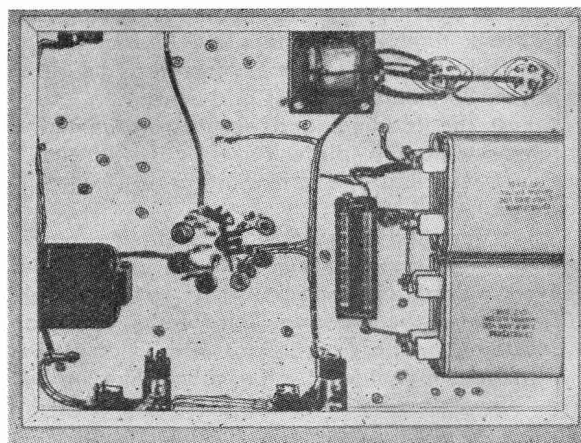

Fig. 4.—Underside View of Chassis.

and the 7094 are made of $\frac{1}{4}$ -inch-wide copper strap. A 4-inch length of RG/8U coaxial cable is used for the connection between the loading capacitor and the output coaxial connector.

The parasitic suppressor in the plate lead (L1) is a single turn of $\frac{3}{8}$ -inch-wide copper strap, $\frac{1}{2}$ -inch in diameter, shunted by three 100-ohm, 2-watt composition resistors connected in parallel.

The bypass capacitors for the meter (C10, C11, and C16) and fan (C5 and C6) are feed-through types. They are installed at the points where the leads to these components pass through the chassis.

Because a single 8- μ f capacitor (C13) would not fit underneath the chassis, four 2- μ f capacitors were used.

Tuning and Operating Adjustments

The amplifier requires a single-sideband exciter that can deliver a peak envelope power of approximately 15 watts. To tune the amplifier, connect it to the exciter and to a 50-ohm antenna-feed line or 200-watt, 50-ohm dummy load. Mesh the plates of the loading capacitor (C18) to unload the valve, throw the meter switch to the "PLATE CURRENT" position, and then apply heater and plate voltage to the 7094. With no excitation applied, the plate current should be 35 to 40 milliamperes.

Switch the meter to read grid current, apply a single-tone modulating signal to the exciter, and quickly adjust the drive to the amplifier until the grid current of the 7094 is approximately 50 milliamperes. Then immediately switch the meter to read plate current and tune the plate tank for minimum current.

Reduce the loading capacitance, keeping the plate tank tuned, until the plate current is approximately 100 milliamperes. Increase the drive to obtain 80 milliamperes of grid current.

Adjust the loading and plate-tank tuning to obtain a resonant plate current of 200 milliamperes, keeping the grid current at 80 milliamperes.

When supplied with 15 watts of driving power and adjusted as described above, the amplifier delivers a peak envelope power of approximately 200 watts to the antenna. Third-order distortion products under these conditions are 35 db below the two-tone signal level. An exciter delivering less than 15 watts P.E.P. may be used, provided the loading for the 7094 is reduced sufficiently to maintain a 2.5-to-1 ratio between plate current and grid current.

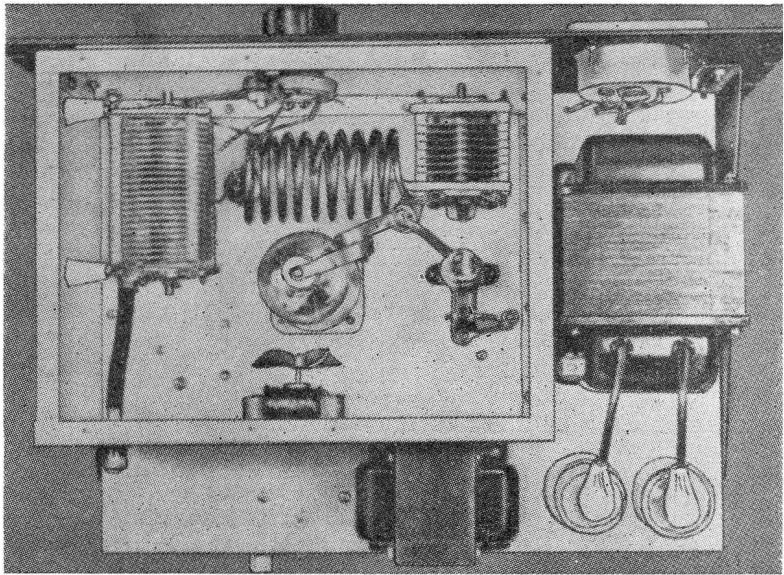

Fig. 5.—Top View of Amplifier, RF Enclosure Cover Removed.

PARTS LIST

- C1, C2, C3, C4, C7, C8, C9, C16—0.01 μ f, 600 v, disc ceramic.
- C5, C6, C10, C11—1000 μ μ f, 500 v, ceramic feed-through.
- C12—.0047 μ f, 3000 v, disc ceramic.
- C13—8 μ f, 2000 v, oil filled.
- C14—1000 μ μ f, 5000 v, ceramic standoff.
- C15—11 to 100 μ μ f, variable.
- C17—500 μ μ f, 5000 v, ceramic standoff.
- C18—19 to 488 μ μ f, variable.
- F1—5 amp fuse.
- F2—1 amp "slow-blow" fuse.
- L1—1 turn, $\frac{1}{2}$ -inch ID (see text).
- L2—9 turns, 2-inch ID (see text).
- L3—23 turns (see text).
- L4—8 henry, 250 ma filter choke.
- M1—0 to 300 ma meter.
- P1, P2—Pilot lamp assemblies.
- RFC1—2.5 mh, 300 ma.
- RFC2—.225 mh, 800 ma.
- R1—1000 ohms, 2 watts, carbon.
- R2—(3) 100 ohms, 2 watts, carbon (see text).
- R3—(2) 100,000 ohms, 50 watts, wire wound (connected in parallel).
- S1, S2—SPST toggle switch.
- S3—DPDT toggle switch.
- S4—5 tap rotary switch, ceramic.
- T1—6.3 v, 4 amp filament transformer.
- T2—2.5 v, 10 amp filament transformer.
- T3—2065-0-2065 v ac, 1750 v dc at 200 ma plate transformer.
- Fan—Small cooling motor and fan.

(With acknowledgements to RCA)

Off The Beaten Track

A SERIES DESCRIBING SOME OF THE MORE UNCOMMON VALVES AND VALVE DESIGNS

An increasingly-frequent requirement in modern electronics is the directly-viewed storage tube, capable of producing a bright and flicker-free display of stored information for up to one minute or even longer after "writing" has ceased. In this sense "writing" means the original presentation of the display of information. A tube of this type may be likened to a cathode ray tube or TV picture tube capable of "holding" picture for an appreciable time after its reception.

It is important to note that a moving or changing picture cannot be displayed on such a tube, but the constantly-changing data could be "sampled", say every 30 seconds or so, and the information displayed until the next "sample" is taken. Frequently it happens that periodic sampling is all that is required, and the flicker-free presentation is of paramount importance.

In other applications, technical limitations in associated equipment can be overcome by this type of tube, as for example in transmitting pictures over telephone lines, where the narrow bandwidth imposes several restrictions. Typical applications of the direct-view storage tube are aeroplane-cockpit radar display, airport surveillance, long range radar, data transmission including half-tones, and narrow bandwidth transmission of data and pictures.

Typical of the direct-view storage tubes available today is the 7183, shown in the photograph of Fig. 1. This tube utilizes two electron guns—a writing gun and a viewing gun, each in its own neck. The writing gun utilizes electrostatic focus and produces an electron beam which is magnetically deflected by external deflecting coils. The viewing gun produces an electron stream which floods the electrodes controlling the storage function and the brightness of the display. The writing and viewing sections of the 7183 are shown in Fig. 2. The writing section contains an electrostatically focused gun that produces an electron beam which is magnetically deflected. The viewing section contains an aluminized screen on the inside surface of a flat faceplate, a backplate capacitively coupled to a storage grid, and a viewing gun having five grids.

No. 5 — DISPLAY STORAGE TUBES

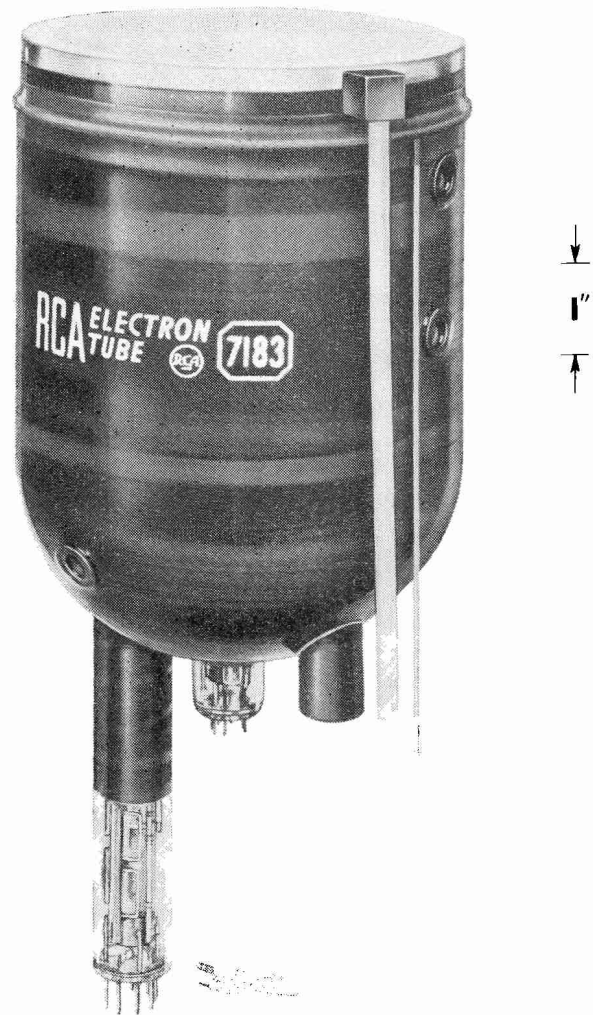

Fig. 1.—Type 7183 Display Storage Tube.

The Viewing Operation

In addition to the viewing gun with its grids No. 1 and No. 2, the viewing section contains a grid No. 3, a grid No. 4, a grid No. 5 storage grid, a backplate capacitively coupled to the storage grid, and a screen having excellent visual efficiency.

The viewing gun provides a low-velocity electron stream which continuously floods the electrodes, (grid No. 5, storage grid, and backplate) controlling the storage function and the brightness of the display. A display with high brightness is possible because of the high viewing-gun current. The high current can be utilized because the viewing beam is not controlled by methods ordinarily employed in cathode-ray tube guns and is consequently not limited by focusing, deflection, and modulating requirements.

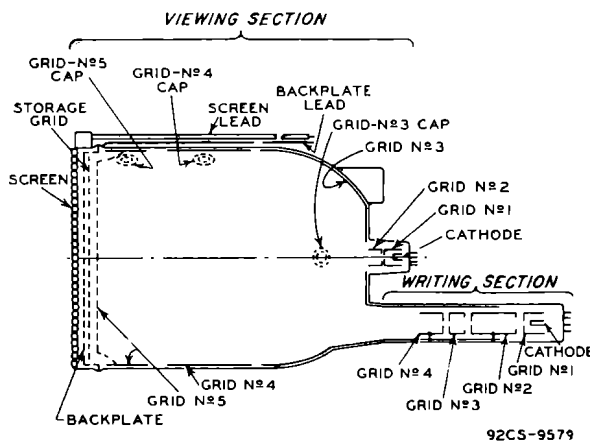

Fig. 2.—Schematic Arrangement of the 7183.

Grids No. 3 and No. 4 each consist of a conductive-coating band positioned on the bulb-wall interior as shown in Fig. 2. These electrodes collimate (make parallel) the paths of the electrons in the stream before they reach grid No. 5. Collimation is required so that the low-velocity electrons will approach the storage grid paths perpendicular (normal) to the plane of the storage grid. This normal approach of the electrons to every point on the storage grid together with their uniform velocity makes possible uniform control of the electrons by the storage grid. Collimation of the viewing section electron stream is shown in Fig. 3.

Grid No. 5 consists of a fine metal mesh together with a conductive-coating band on the bulb-wall interior. It serves to accelerate electrons in the beam; to repel any positive ions, produced by collision of electrons with residual gas molecules in the region between base and grid No. 5, from landing on the storage grid and thus rapidly wiping out a stored charge pattern; and to collect

beam electrons turned back near the storage grid when its potential is negative.

The storage grid consists of a very thin deposit of excellent insulating material covering the gun side of the backplate which is the framework of a fine metallic mesh. The deposit leaves the size of the openings in the mesh essentially unchanged. In effect the storage grid consists of a multiplicity of storage elements, each capacitively coupled to the mesh.

The storage grid serves to control the viewing beam so that the stored information can be displayed on the phosphor (screen). If the storage-grid potential is made sufficiently negative with respect to the viewing-gun cathode, electrons in the viewing beam are turned back as they approach the storage grid and are collected by grid No. 5. Under this condition, the viewing beam is cut off.

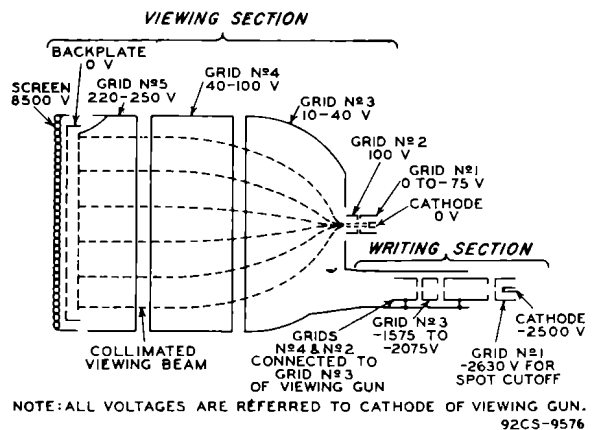

Fig. 3.—Collimation of the Viewing Beam.

When the storage grid is at the same potential as the viewing-gun cathode, electrons in the viewing beam approach sufficiently near the plane of the storage grid to be attracted by the viewing-screen field which penetrates the openings in the storage grid. Under the influence of this field, a majority of the viewing-beam electrons which have passed through grid No. 5 are accelerated through the storage-grid and backplate openings to the phosphor (screen), and cause it to fluoresce brightly over its entire area. Under this condition, the brightness of the screen is designated as "saturated brightness".

Light output from the screen under conditions of saturated brightness varies with the voltage applied to the screen. At values of storage-grid potential between those which produce viewing-beam cutoff and those which produce saturation brightness, the number of electrons which penetrate the storage-grid openings, and hence the amount of light emitted by the screen, is a function of the storage-grid potential.

Within the range of storage-grid potentials considered thus far, no viewing-beam electrons are attracted to the surface of the storage grid. Hence, in the absence of deliberate writing, leakage through the insulating material, of spurious charging such as might be caused by positive-ion bombardment, a charge pattern once established on the storage grid should remain indefinitely. If, however, the storage grid is made positive with respect to the viewing-gun cathode, viewing-beam electrons are attracted to the surface of the storage grid and land on it. If the electrons which land do not have sufficient energy to produce unity, a net flow of current into the storage grid a secondary-electron emission ration in excess of will result. Because the storage grid is conductively isolated from the metallic backplate, the storage grid is free to charge negatively under the influence of this current.

This negative-charging phenomenon provides a mechanism by means of which an undesired charge pattern on the storage grid can be removed, i.e., erased. For example, assume that the entire storage grid has been charged, by writing, to zero potential with respect to the cathode of the viewing gun. The cathode of the viewing gun is usually taken as a ground reference. Now, assume that the backplate is suddenly shifted from its "dc" potential level of 0 volts to a positive potential of 10 volts. Because of the very close capacitive coupling between the backplate and the storage grid, the storage grid also rises to a potential of 10 volts. Viewing-beam electrons are now able to land on the storage grid and negative charging of the storage grid takes place, as explained above. Charging continues until the storage-grid potential is reestablished at zero volts. When this occurs, viewing-beam electrons can no longer land on the storage grid. Now, if the backplate potential is returned to its initial value of zero volts, the storage-grid potential drops correspondingly to -10 volts. This negative voltage essentially cuts off the viewing beam and thus erases any charge pattern on the storage grid.

Following erasure, the time available for writing and viewing is limited by the presence of positive ions produced by collision of electrons in the viewing beam with residual traces of gas in the region between the screen and grid No. 5. These positive ions are attracted to the most negative elements of the storage grid. On landing, the ions cause the elements to assume a less-negative charge and thus to increase the flow of viewing-beam electrons to the screen. Thus, the limit of viewing duration is determined by loss of contrast in the viewed pattern rather than by a decay of brightness as in the case of long-persistence phosphors.

In some applications, it may be desirable to sacrifice brightness for a viewing duration longer than that indicated in the tabulated data. Extended viewing duration may be obtained by modulating the viewing beam with rectangular

pulses applied to grid No. 1 of the viewing gun at a pulse repetition frequency above that which produces display flickering. The minimum usable frequency is determined by the persistence characteristic of the screen phosphor and is in the order of 30 pulses per second. Screen brightness varies directly and viewing duration varies inversely with the grid-No. 1—pulse duty cycle.

The Writing Operation

The writing gun is similar to that used in electrostatically focused and magnetically deflected oscillograph tubes, and produces a well-defined focused beam having exceptionally small effective area at the storage grid. This beam may be deflected and modulated in the same manner as for oscillograph tubes. It has a control function and contributes little to the total light output from the tube.

The writing-beam electrons landing on the storage grid have sufficient velocity to produce a secondary-electron emission ratio greater than unity. Thus, more electrons leave the storage grid than arrive, and those elements on the storage grid scanned by the beam assume a less-negative charge wherever the writing beam strikes. Because the secondary electrons are attracted to grid No. 5 of the viewing gun, the writing beam tends to charge the storage grid to the potential of grid No. 5 of the viewing gun. However, the maximum potential to which an element of the storage grid rises above cutoff is limited in normal operation of the tube by the viewing-gun beam to a potential just slightly more positive than that of the viewing-gun cathode.

The writing-beam electrons which land on a storage element determine the voltage built up across the dielectric and the corresponding net charge stored in the dielectric. By controlling the amplitude and duration of the writing-beam current, it is possible to establish on any storage element a positive charge having a value which will partially or completely counteract that element's negative charge. Consequently, a storage element can be charged to any potential intermediate between the storage-grid-cutoff voltage and zero voltage.

As considered previously, the potential of any storage element determines the number of viewing-beam electrons passing through the storage grid in the immediate vicinity of that element. When the potential is such as to allow passage of electrons, these electrons are accelerated and strike the screen directly opposite the storage element. As a result, they produce a luminescent spot having a size only slightly larger than that of the storage element and a brightness which is directly proportional to their density and their velocity which is determined by the screen potential.

Because the potential of a storage element is not changed by the viewing operation, a charge pattern established by the writing gun on the stor-

age grid produces a corresponding visible pattern on the screen which may be viewed for a period determined by positive-ion build-up or by the pre-determined erasure rate when dynamic erasure is employed.

The multiplicity of storage elements on the storage grid permits storage of half-tone patterns and their display. At a display brightness approximately 50 per cent of saturated brightness, half-tone patterns have a resolution of about 50 lines per inch.

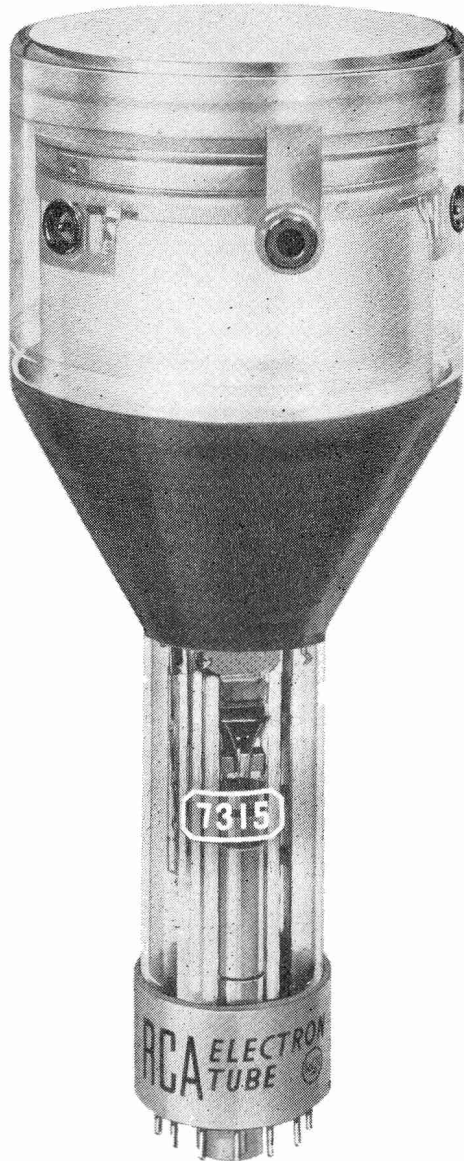

Fig. 4.—Type 7315 Display Storage Tube.

The Erasing Operation

In the section headed The Viewing Operation, a technique for erasing stored charge patterns was described. This technique, known as static erasure, has the following disadvantage. During the eras-

ing cycle and the time thereafter required to write a new pattern, the display conveys no information or incomplete information. It is also to be noted that during the static erasing cycle, the screen is uniformly illuminated at a level equal to, or greater than, the saturated brightness level.

In most applications of the 7183, it is desired that writing be followed by a gradual decay of stored information. This kind of performance is obtained by applying a continuous series of pulses to the backplate at a rate no lower than the phosphor flicker frequency (refer to section headed "The Viewing Operation"). The technique of erasing by applying a series of pulses to the backplate is known as dynamic erasure.

The amount of charge erased during each erasing pulse is dependent on the duration, amplitude, and shape of the pulse. These factors together with the erasing-pulse repetition frequency determine the observed rate of decay of stored information. Erasing pulses whose amplitude is smaller than the magnitude of the viewing-beam

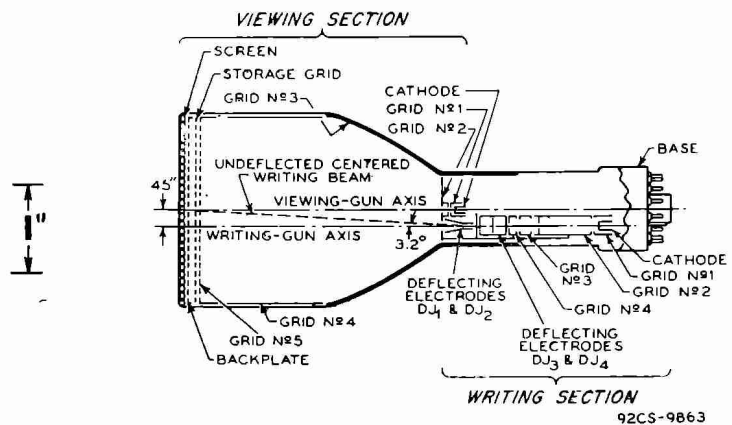

Fig. 5.—Schematic Arrangement of the 7315.

cutoff voltage do not permit complete erasure. On the other hand, erasing pulses whose amplitude is greater than the magnitude of the viewing-beam cutoff voltage eventually drive the storage-grid beyond cutoff, i.e., to a value "blacker than black".

The choice of erasing-pulse amplitude depends on the application contemplated by the equipment designer. When a linear decay is required, the erasing-pulse amplitude should be set so that the transition of the decay characteristic from linear to quasi-exponential occurs at or near viewing-beam cutoff. If at the same time it is desired to display weak input signals, it is necessary to adjust the writing-beam "unblanking" level in the absence of input signals so that the writing beam charges the storage grid just to the cutoff level at the instant of writing.

With a rectangular type of erasing pulse, all storage elements are erased at nearly the same

rate regardless of the charge on any storage element. The brightest elements of the viewed pattern, therefore, are visible for longer periods than half-tones.

When the pulse used for erasing is of the positive-going sawtooth type, the most positive storage elements are erased more rapidly than the others, because electrons in the viewing-beam land on these elements for a longer period. With this kind of erasure, half-tones persist as long as bright elements.

In applications where half-tone display is involved, the amplitude of the rectangular erasing pulse should be adjusted so that the storage surface is charged to exactly cutoff potential by the erasing operation.

In applications, such as radar, where it is desired to suppress noise in the display, a higher-amplitude erasing pulse may be used to lower the potential of the unwritten storage elements several volts below cutoff. A number of addresses by the

writing beam is then required to charge the storage elements less negative than cutoff. Ideally, the erasing-pulse amplitude should be adjusted so that the noise component in the modulated writing beam charges the storage surface to just cutoff. Then, the signal superimposed on the noise signal charges the storage elements to a potential less negative than cutoff and thus is effectively displayed on the screen devoid of noise background.

Other Storage Tubes

The type 7183 just discussed is of course only one of several such tubes available. It uses an external magnetic field for deflecting the writing beam. Another tube, the 7315, shown in the photograph of Fig. 4, is similar except that it uses electrostatic deflection of the writing beam. The schematic arrangement of this tube is shown in Fig. 5. The principle of operation is of course similar to that previously described for the 7183.

NEW RCA RELEASES

RADIOTRON 1J3, 1K3

The 1J3 and 1K3 are half-wave vacuum rectifiers of the glass-octal type utilizing a coated filament. They are intended for use as rectifiers of high-voltage pulses produced in TV scanning systems. The 1K3 is like the 1J3 but is constructed in a shorter bulb for more compact equipment designs.

In pulsed-rectifier service, the 1J3 and 1K3 are rated to withstand a maximum peak inverse plate voltage of 26000 volts (Design Maximum). They can supply a maximum peak plate current of 50 milliamperes and a maximum average plate current of 0.5 milliampere.

RADIOTRON 7360

The 7360 is a new beam-deflection valve of the 9-pin miniature type designed specifically for use in single- and double-sideband, suppressed-carrier communications equipment. It is capable of operating at frequencies up to 100 Mc. The 7360 makes possible the design of simplified, low-cost circuits such as product detectors, balanced modulators capable of providing a carrier suppression in the order of 60 db, and balanced mixers providing oscillator-signal suppression of at least 40 db. This valve is also well suited for use in low-distortion audio-fader circuits, remote switching of studio and high-fidelity equipment, and in other applications in which isolation of the control voltage from the signal is an important design requirement.

Some of the major advantages offered by the 7360 to equipment designer are:

1. Push-pull output with single-ended input.
2. Self-excited operation. (No need for separate oscillator tube.)
3. Internal shielding to minimize interaction between deflecting electrodes and the control grid.
4. High deflection sensitivity.
5. High transconductance.
6. High input impedance.
7. Exceptionally stable balance over a wide temperature range and during life.

RADIOTRON 7536

The 7536 is a small, cylindrical, side-on type of cadmium-sulphide photoconductive cell for use in a variety of industrial light-operated relay applications. The 7536 has an illumination sensitivity of 300 microamperes per footcandle at 25°C; a maximum current capability of 1000 microamperes; and a maximum power-dissipation rating of 50 milliwatts. The photosensitive area is 0.2 inch x 0.2 inch. The voltage applied between terminals may be as high as 200 volts.

This new cell is hermetically sealed in a glass envelope to permit operation under conditions of high humidity. It has a maximum diameter of 0.3 inch and a maximum length (excluding flexible leads) of 1.35 inches. Spectral response of the 7536 covers the approximate range from 3300 to 7400 angstroms. Maximum response occurs at about 5800 angstroms.

RCA SEMICONDUCTOR PRODUCTS HANDBOOK HB-10 COMPANION TO THE WORLD-RENOWNED TUBE HANDBOOK HB-3

A new technical publication, the RCA SEMICONDUCTOR PRODUCTS HANDBOOK HB-10, is devoted exclusively to data on RCA semiconductor devices, including transistors and silicon rectifiers.

The new HB-10 Handbook, in a handsome easy-to-identify, gold-imprinted, red cover is $5\frac{5}{8}$ in. x $7\frac{3}{8}$ in. and contains currently over 400 pages. This Handbook has been compiled to meet the requirements of electronic equipment design engineers primarily, but will prove useful to all who have need for up-to-date technical information on RCA semiconductor devices. The convenient loose-leaf form permits revision of data on existing types and the addition of data on new types as they are made available. Data include intended uses, characteristics, typical operation, maximum ratings, terminal connections, commonly used curves plotted to easily readable scales for solving design problems, and mechanical dimensions for the RCA line of semiconductor devices.

RADIOTRONICS BACK NUMBERS

Back numbers of "Radiotronics" issued since January, 1958 are available at time of going to press, except January and February 1959. The increased demand for the magazine has greatly reduced the availability of back numbers, whilst increased costs means that the number of extra copies printed must be limited.

The only way to ensure that you receive "Radiotronics" regularly is to open a subscription.



Radiotronics is published twelve times a year by the Wireless Press for Amalgamated Wireless Valve Company Pty. Ltd. The annual subscription rate in Australasia is 10/-, in U.S.A. and dollar countries \$1.50, and in all other countries 12/6. Price of a single copy is 1/-.

Subscribers should promptly notify Amalgamated Wireless Valve Company Pty. Ltd., Box 2516, G.P.O., Sydney, and also the local Post Office of any change of address, allowing one month for the change to become effective.

Original articles in Radiotronics may be published without restrictions provided that due acknowledgement is given.

Devices and arrangements shown or described herein may use patents of AWV, RCA or others. Information is furnished without responsibility by AWV or RCA for its use and without prejudice to AWV's or RCA's patent rights. Information published herein concerning new RCA releases is intended for information only, and present or future Australian availability is not implied.

EDITOR BERNARD J. SIMPSON