

EMI

photomultiplier tubes

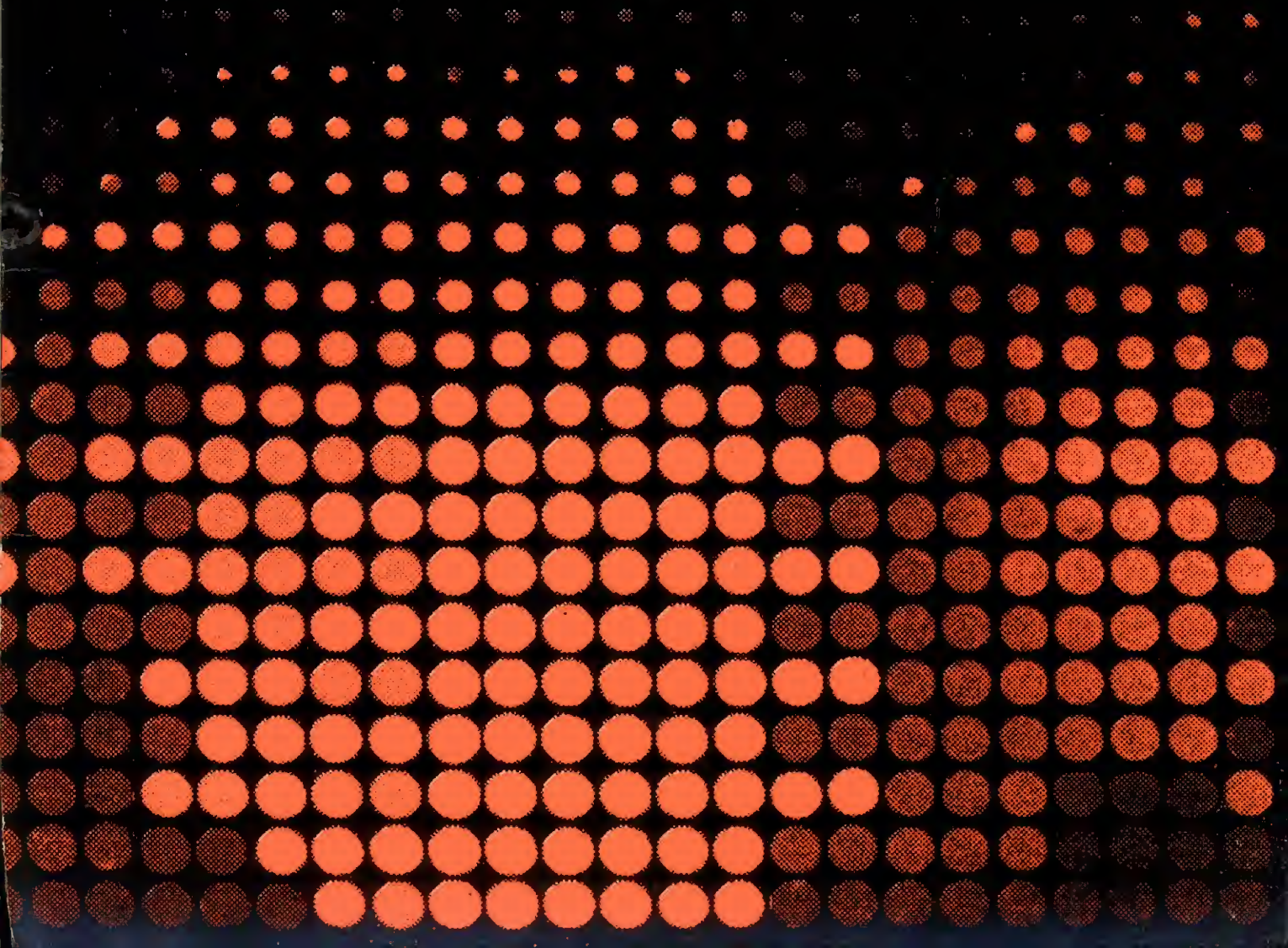

Index

Photomultiplier Tubes & Windowless Electron Multipliers

List of Tube Types

Type	Page	Type	Page	Type	Page
6094B	36	9596QUB	56	9670B	18
6094S	36	9597B	56	9684B	32
6097B	30	9597QB	56	9684QB	32
6097L	30	9597UB	56	9698B	24
6097S	30	9597QUB	56	9698QB	24
6097KB	30	9600B	40	9700B	42
6097KL	30	9601B	20	9707B	16
6097KS	30	9603/2B	16	9708B	44
6255B	30	9618B	50	9708L	44
6255S	30	9618R	50	9708R	44
6256B	36	9618TB	50	9708KB	44
6256S	36	9623B	52	9708KR	44
9502B	36	9634QB	28	9708QB	44
9502S	36	9634QR	28	9708QR	44
9514B	30	9635B	38	9709B	50
9514S	30	9635QB	38	9709R	50
9524B	20	9637B	26	9709KB	50
9524S	20	9637R	26	9709KR	50
9526B	20	9637KB	26	9709QB	50
9526S	20	9638B	40	9709QR	50
9529B	22	9643/2B	16	9710B	44
9530B	50	9643/4B	16	9710TB	44
9530R	50	9644NB	59	9711NB	59
9530KB	50	9644QNB	59	9711QNB	59
9530KR	50	9647NB	59	9712NB	59
9530QB	50	9647QNB	59	9712QNB	59
9530QR	50	9656B	28	9726B	40
9531B	48	9656F	28	9726KB	40
9531R	48	9656L	28	9727B	42
9531QB	48	9656R	28	9732B	48
9531QR	48	9656S	28	9732R	48
9536B	28	9656KB	28	9734B	20
9545B	54	9656KF	28	9734QB	20
9558B	34	9656KL	28	9734NB	59
9558QB	34	9656KR	28	9734QNB	59
9592B	22	9656KS	28	9750B	38
9594B	56	9658B	34	9750KB	38
9594QB	56	9658R	34	9750QB	38
9594UB	56	9659B	34	9750QKB	38
9594QUB	56	9659QB	34	9758B	46
9595B	56	9660B	18	9758KB	46
9595QB	56	9661B	18	9781B	18
9595UB	56	9662B	18	9783B	18
9595QUB	56	9663B	18	9790B	46
9596B	56	9664B	18	9790KB	46
9596QB	56	9665B	18	9791B	46
9596UB	56	9669B	18	9791KB	46

Main Sections

	Page
An introduction to the photomultiplier	3
Dark current shot noise equivalent inputs	12
Time characteristics	12
Spectral response and window transmission curves	13
Dynode chain design	14
Typical applications	15
Photomultiplier specifications	16

Tube diameters

30mm nominal	20-25
50mm nominal	26-39
75mm nominal	44-47
90mm nominal	48-49
100mm nominal	48-49
130mm nominal	46-47, 50-51
190mm nominal	52-53
310mm nominal	54-55

Special Types

Windowless electron multipliers	16-17
Side window types	18-19
2 π sensitivity	40-41
High temperature	42-43
Fast linear focused	56-58
Rugged types	59-62

Sockets and Shields

63-64

Suffix Designations

A	selection to customer's requirements
B	standard published specification
C	less stringent limits than "B" specification
F	selection to suit film scanning
K	fitted with diheptal B14A base
L	guaranteed energy resolution to Co ⁶⁰
M	precise spectral calibration supplied
N	resistant to vibration scheduled on p. 59
Q	variant having quartz end window
R	variant with superior cathode which includes a guaranteed energy resolution to Co ⁶⁰ for some types
T	variant with trialkali (S-20) photocathode

Note: Information contained herein supersedes all previous published information. Manufacturer reserves the right to modify designs and specifications without prior notice.

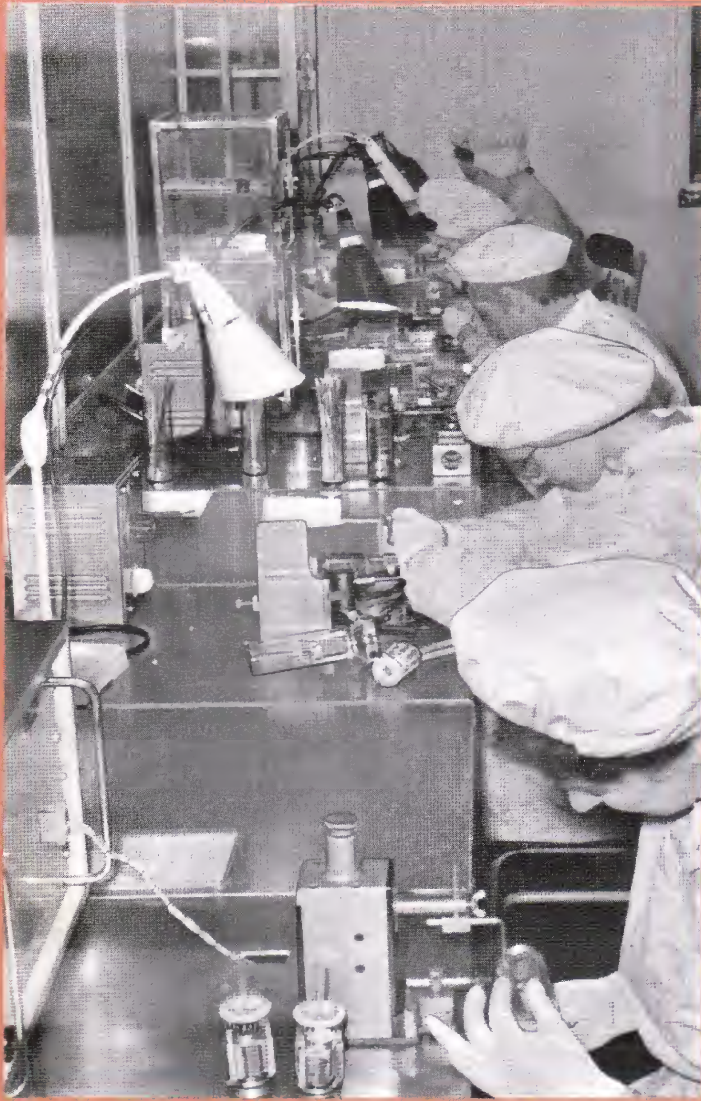

Photomultiplier tubes
being assembled under
clean air conditions

Final stages in the manufacture of
photomultiplier tube envelopes

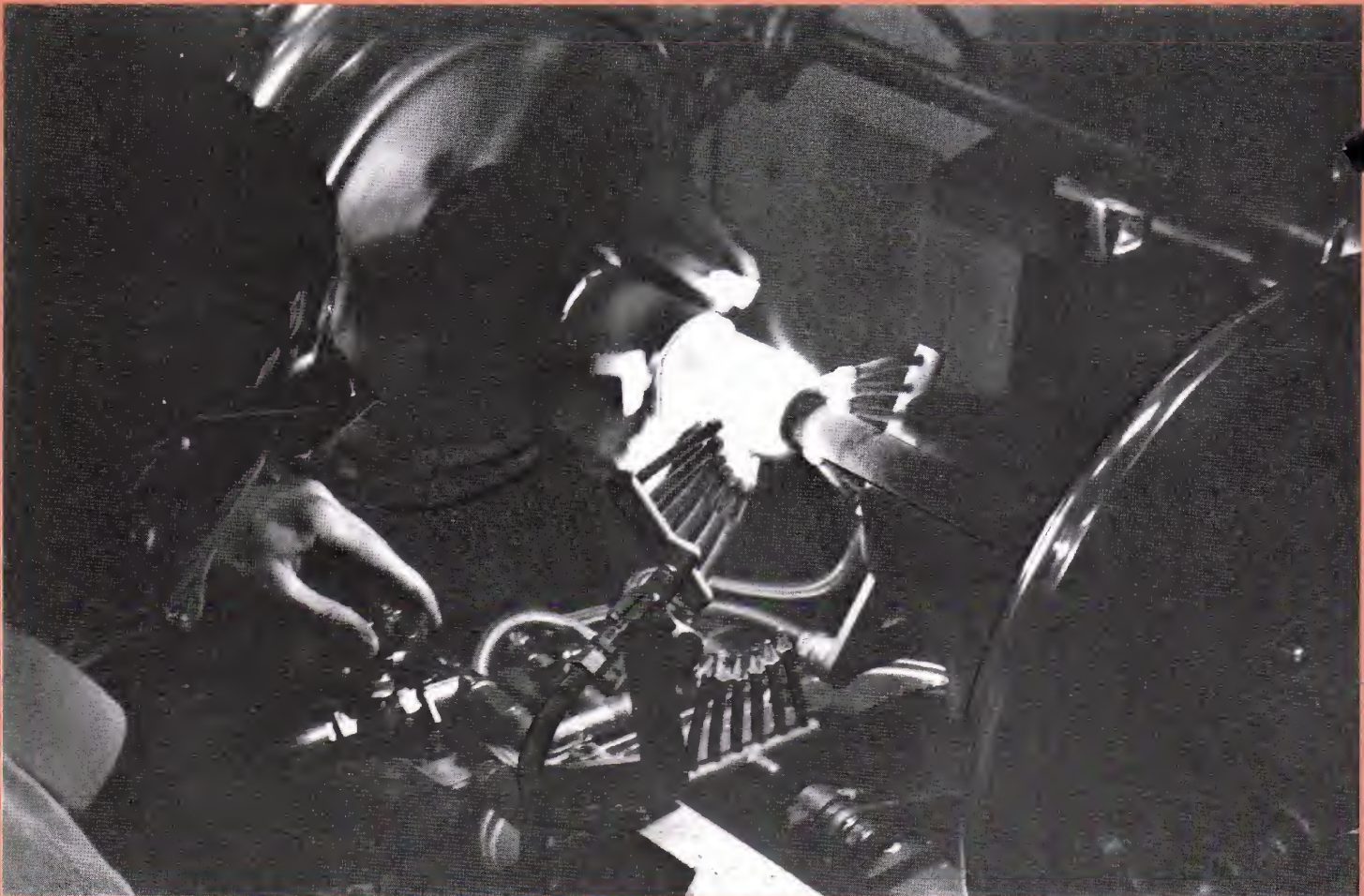
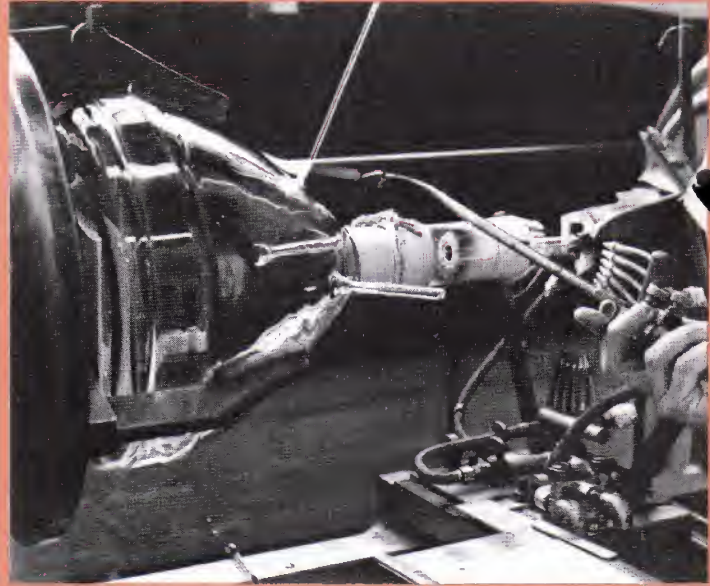

An Introduction to the Photomultiplier

These notes are primarily intended to be of use to those with only a limited acquaintance with photomultipliers, and those who are specialists in fields other than electronics. The information given below should enable the user to choose the most appropriate tube for his application and obtain a basic understanding of the limitations of the device. Information on the design of ancillary circuitry and power supply requirements is also included.

1. How it Works

A photomultiplier may be conveniently sub-divided into a photocathode, an electron-optical input system, a secondary emission multiplier, and an anode. In end-on photomultipliers, the photocathode is deposited on the inside of the tube window and is semi-transparent. An alternative system employs an opaque cathode situated some distance within the glass envelope. Historically, the most celebrated photocathode is a compound of antimony and caesium. In more recent years, cathodes have been developed giving increased photoelectric efficiency and extended spectral sensitivity, e.g. the KNa_2CsSb trialkali cathode. The relative merits of the various photocathodes in the EMI range are discussed in Section 3(ii).

Photoelectrons from the desired area of the cathode must be guided onto the first dynode of the secondary emission multiplier with the maximum possible efficiency. This is achieved by the optimisation of the cathode to first dynode geometry, and the maximisation of the K-D1 collecting field. Improvements in K-D1 geometry have rendered the incorporation of focus electrodes in several larger diameter EMI tubes obsolete.

Photoelectrons impinging on the first dynode produce a number of secondary electrons which are accelerated onto the next dynode of the multiplier where they, in turn, produce secondaries. A potential gradient is maintained between the successive dynode stages, usually by means of a suitable resistor chain (see Sections 5 and 6). In general CsSb dynodes are used in EMI tubes because of their extremely good stability and high gain, although alloy dynodes are employed in tubes designed for use at very high temperatures and in windowless electron multipliers.

The last dynode is in the form of a shallow box, within which the anode mesh is stretched. Electrons from the penultimate dynode pass through the anode mesh to strike the last dynode; the low energy secondaries produced are then collected at the mesh.

2. The Parameters Involved

Before proceeding further, it is necessary to define some of the parameters by which the performance of a photomultiplier is assessed:

(i) QUANTUM EFFICIENCY $Q(\lambda)$

The quantum efficiency of a photocathode to light of wavelength λ is defined as the number of photoelectrons emitted from the photocathode per incident photon. This ratio is usually expressed as a percentage. Information on the quantum efficiencies of the various photocathodes available at their wavelengths of peak response is given in Section 3(ii).

(ii) RADIANT SENSITIVITY $E(\lambda)$

From Einstein's law the energy of the photon is $\frac{hc}{\lambda}$ where h is Planck's constant and c is the velocity of light. If a radiant power of P watts with a wavelength λ metres is incident on a photocathode, the number of photons will be $\frac{P\lambda}{hc}$ and so the photocurrent from the cathode will be:

$$I_K = \frac{P \cdot \lambda \cdot e \cdot Q(\lambda)}{hc} \text{ Amps} \quad (1)$$

where e is 1.6×10^{-19} coulombs (the electronic charge), h is 6.62×10^{-34} Joule. sec. and c is 3×10^8 metres. sec $^{-1}$.

From this it follows that the radiant cathode sensitivity $E(\lambda)$ (in mA/watt) is given by

$$E(\lambda) = \frac{I_K}{P} = \frac{\lambda \cdot e \cdot Q(\lambda) \times 10^3}{hc} = \frac{\lambda \times Q(\lambda) \times 10^9}{1.2395} \quad (2)$$

As an example, a photocathode with 25% quantum efficiency at a wavelength of 0.400μ has a radiant sensitivity of

$$\frac{(0.4 \times 10^{-6}) \times 0.25 \times 10^9}{1.2395} \text{ mA/W} \\ = 80.68 \text{ mA/W}$$

(iii) CATHODE SENSITIVITY

It is customary for photocathode sensitivities to be quoted in units of $\mu\text{A/lumen}$ rather than in quantum efficiency or mA/Watt because both quantum efficiency and mA/Watt have to be specified at a particular wavelength. The lumen is related to the response of the human eye and covers a wide spectral range. Furthermore it is difficult to define a narrow band emission source with precision but a tungsten filament lamp is an inexpensive and easily reproduced standard. The standard C.I.E. luminance corresponds to that of a black body at a temperature of 2857°K which is closely approximated to by a tungsten filament lamp operated at this colour temperature. EMI measurements of cathode sensitivity are referred to such a source.

The relationship between sensitivity in $\mu\text{A/lm}$ and quantum efficiency or radiant sensitivity is given in Section 8.

(iv) GAIN

The electron gain (G) of a photomultiplier should ideally be given by:

$$G = (\delta)^n \quad (3)$$

where δ is the average secondary emission coefficient and n is the number of dynodes.

However, this expression takes no account of the fact that the K-D1 collection efficiency (f) will inevitably be less than 100%, as will the transfer efficiency of electrons between dynodes (g) although g is almost 100%. A more realistic expression is therefore:

$$G = f(g\delta)^n \quad (4)$$

Values of f of the order of 90% are obtainable, and values of $g\delta \sim 4.5$ at moderate operating voltages are readily obtainable with EMI tubes.

An empirical relation for δ in the case of CsSb dynodes is:

$$\delta = 0.2 (V_s)^{0.7} \quad (5)$$

where V_s is the interdynode voltage.

The relation for caesiated AgMgO dynodes is:

$$\delta = 0.025 V_s \quad (6)$$

The actual gain, taking account of all losses due to imperfect collection and transfer efficiency, may be conveniently determined by measuring the overall sensitivity of the photomultiplier (M) at the anode. This quantity is measured in units of Amp/lumen referred to the same tungsten source as is used to measure the cathode sensitivity S ($\mu\text{A/lumen}$).

The gain G is thus given by:

$$G = \frac{M}{S} \times 10^6 \quad (7)$$

(v) DARK CURRENT

When a photomultiplier is operated in complete darkness, electrons are still emitted from the cathode due to agencies other than incident light. The resulting "dark current" is amplified by the multiplier system, and sets a limit to the lowest intensity of light which can be detected directly. It is thus desirable that dark current should be minimised. With most photocathodes thermionic emission appears to be responsible for the largest component of the dark

current. At ambient temperatures the thermal dark current (I_t) obeys Richardson's law approximately, i.e.:

$$I_t = 1.20 \times 10^2 T^2 \exp\left(\frac{-1.16 \times 10^4}{T} \phi_i\right) \text{ Amp.cm}^{-2} \quad (8)$$

where T is the absolute temperature in $^\circ\text{K}$ and ϕ_i is the thermal work function for the cathode material. (This quantity is discussed more fully in Section 3(ii).)

It is clear that cooling the photomultiplier will have the effect of reducing the thermal component of the dark current and a reduction by a factor of 10 may be obtained by cooling a tube with an antimony caesium cathode from room temperature to 0°C ; a corresponding reduction by a factor of about 16 may be obtained under similar conditions for a trialkali cathode.

For all cathodes except the AgOCs (S-1) type, it is found that the thermal component of the dark current may be virtually eliminated by cooling to -40°C , and no significant improvement is obtained in cooling to temperatures below this. The S-1 cathode has an intrinsically high thermal dark current, and in this case it is profitable to cool to liquid nitrogen temperatures. (See Section 3(vii) (e).)

The residual dark current consists mostly of multiple electron pulses which are due in large measure to Cerenkov photons produced in the tube window by the passage through it of relativistic β -particles from the disintegration of K^{40} occurring naturally in the window material (also small concentrations of Radium and Thorium), and of relativistic μ -mesons of cosmic origin. Glass fluorescence due to external γ -bombardment may also contribute. Quartz contains considerably less naturally occurring radioactive materials than other commonly used window materials so the residual dark current when cooled may be reduced by using a tube with a quartz window.

Although photomultipliers are normally stored in boxes, they may with impunity be exposed to daylight, provided of course that the high voltage is not applied! However, this results in the trapping of energy in the cathode. When the tube is placed in the dark it takes some time for this energy to be dissipated in the emission of electrons. If the high voltage is applied to a tube at this time, this effect will manifest itself as an excessive dark current. After a period of 24 to 48 hours in the dark (during which time the high voltage need not be applied), the dark current should have fallen to its equilibrium value.

(vi) NOISE

It is most important to distinguish between electrical noise and dark current since noise is a term which is used to describe many different effects. The essential difference is that dark current is a spurious direct current whereas noise is a statistical fluctuation in the output, due to the quantised nature of the photoelectric current. The fluctuations in the signal can be described as signal noise and the fluctuations in the dark current as dark noise. A more detailed treatment of noise in photomultipliers is given in Section 3(v); noise usually presents the basic limitation to accuracy of measurement.

(vii) THE TEST TICKET

Each EMI photomultiplier is individually tested prior to despatch, and is supplied with a test ticket specifying the cathode sensitivity in $\mu\text{A/lm}$ (S), the overall tube voltage necessary to give a stated overall sensitivity (M), and the dark current at that value of M at 20°C . This information is very useful when designing an appropriate dynode resistor chain (see Section 6).

With certain types, other parameters are also specified. Further details of these are given with the individual tube data.

E.M.I.			
TYPE No. 9524B			
SERIAL No. 30,000			
CATHODE		70	$\mu\text{A/L}$
A/L	VOLTS O/A	D.C. nA	
10			
50			
200	950	1	
2000			

3. Factors Affecting the Choice of Tube

(i) PHYSICAL

Selection of tube and cathode size can be made from the data sheets commencing on page 16. For spectrophotometric applications requiring exceptionally low dark current, 50mm tubes are available with 10mm cathodes (see page 36).

Another choice which must be made is between an end-on tube with a semi-transparent cathode, and a side-window tube with an opaque cathode. The advantages of the end-on configuration are numerous. Principal among these is the facility with which close coupling between the photocathode and a diffused light source may be achieved, and the accuracy with which the distance between source and cathode may be determined.

(ii) SPECTRAL RESPONSE

Curves appear on page 13 showing the variation of typical quantum efficiencies with wavelength for the different cathodes currently available in the EMI range. In the table below additional properties of these cathodes are summarised:

TABLE 1

Cathode Type	Composition	Peak λ	Typical Q (λ peak) Electron/photon	Typical E (λ peak) mA/watt	Typical μ A/lm
S-20	Na ₂ K ₂ Sb-Cs	3800	0.22	67.5	150
S-11	Cs ₃ Sb-O	3900	0.19	59.8	70
"S"	Cs ₃ Sb	3800	0.16	49.0	50
"Super" S-11	Cs ₃ Sb-O	4100	0.23	76.0	95
S-10	BiAgOCs	4200	0.068	23.0	55
S-1	AgOCs	(3600) 8000	0.004	2.58	25
Bialkali (ambient temp.)	K ₂ CsSb	3800	0.27	82.8	80
Bialkali (high temp.)	Na ₂ K ₂ Sb	3600	0.21	60.9	40

The photoelectric effect depends on the occurrence of inelastic collisions between incident photons and electrons in the photo-

cathode, the equation for the energy exchange being:

$$\frac{hc}{\lambda} = E + \phi_p \quad (9)$$

where $\frac{hc}{\lambda}$ is the energy of the absorbed photon; ϕ_p is the photoelectric work function of the cathode; E is the kinetic energy of the resultant photoelectron.

The long wavelength threshold λ_o , where E is zero is thus determined by the work function ϕ_p and is given by:

$$\lambda_o = \frac{hc}{\phi_p} \quad (10)$$

In the case of a metal, this threshold is sharply defined, but a semiconductor photocathode manifests a long wavelength "tail" in addition which is traceable to emission from impurity levels. Thus, cathodes with appreciable sensitivity in the red—near IR spectral regions (S-10, S-20, S-1) have low values of the photoelectric work function.

In the case of a metal, the photoelectric work function ϕ_p and the thermionic work function ϕ_t are identical. In the case of a semiconductor photoemitter, this is not so and $\phi_p > \phi_t$. Thus, it is not possible to obtain a cathode of high red sensitivity by lowering ϕ_p without also decreasing ϕ_t and consequently increasing the dark current. In cathodes designed for applications in which dark current is a limiting factor, (such as the EMI "S" type) some cathode sensitivity must therefore be sacrificed and the red response is reduced in this case.

The K₂CsSb alkali cathode also has low red sensitivity and extremely low dark current at room temperature. However, the peak quantum efficiency may be as high as 30%, so tubes with such cathodes are ideal for low level scintillation counting (e.g. EMI 9635Q and 9750).

The limit of short wavelength response is a function of the transmission properties of the window material employed. Curves appear on page 13 showing the variation of % transmission with wavelength for the various window materials currently in use.

For high sensitivity over a very wide spectral region, a quartz window tube with an S-20 cathode should be chosen (EMI types 9558QB and 9698QB). Wide spectral coverage is also obtained at

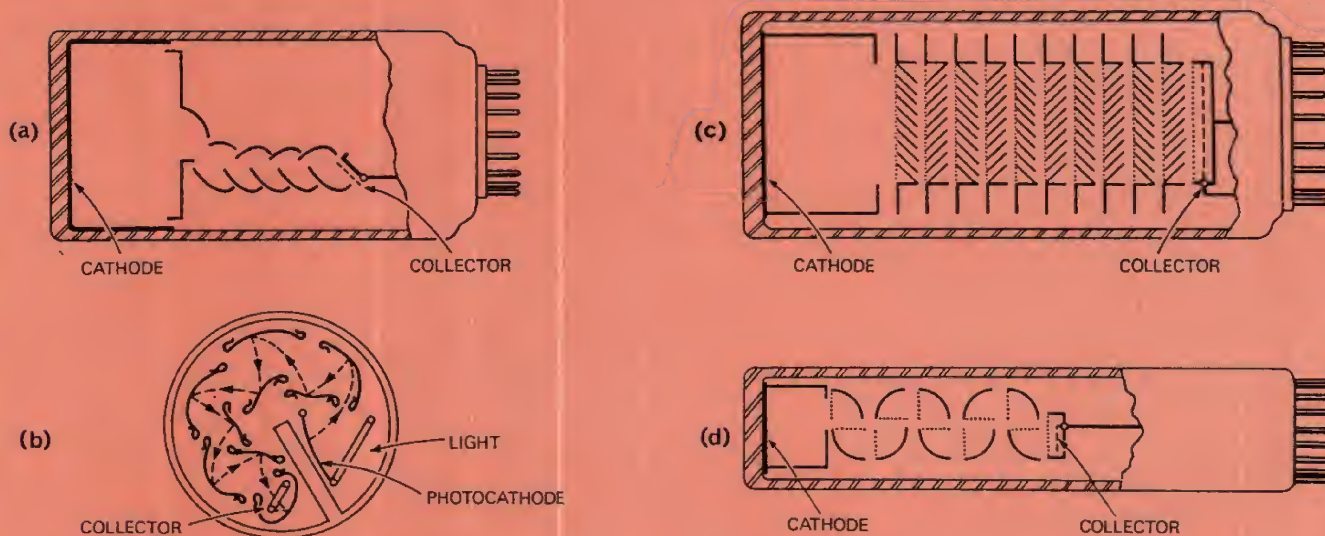

Fig (i) Electrostatic dynode systems; (a) focused structure, (b) compact focused structure, (c) venetian-blind structure, (d) box-and-grid structure

lower cost by employing a tube incorporating an S-10 cathode (EMI types 9592B and 9664B). For applications extending into the near IR it is necessary to select a tube with an S-1 cathode (EMI types 9684B and 9710B). For work at elevated temperatures tubes incorporating a Na₂K₂Sb alkali cathode should be chosen (EMI types 9727B and 9700B): these types may be operated at temperatures up to 150 C, although with reduced life at that temperature.

For applications requiring all-round tube merit, the "R" grade will be most suitable. Tubes of this grade are resolution tested for gamma spectroscopy wherever appropriate.

(iii) GAIN REQUIREMENTS

The various dynode systems available in EMI photomultipliers are shown in Fig. (i). Fig. (ii) shows the relative gain variation of the various geometries as the potential of one of the intermediate dynodes is varied: it will be seen that the unfocused systems shown in Fig. (i) (c) and (d) are significantly less sensitive than the two focused configurations shown in Fig. (i)(a) and (b).

For applications requiring the best available gain stability with time, a tube with a CsSb venetian blind dynode system should be selected, as the gain drift for such a tube has been determined to be less than 0.7% per period of 24 hours operation.

The gain of a box and grid structure dynode system shows only marginally greater sensitivity to voltage fluctuations compared to that of a venetian blind system, and will give slightly higher gain per stage for a given applied voltage.

The advantage of the linear focused system is that the directing fields between dynodes are higher than in the unfocused cases, and constrain the secondary electrons into paths with little spread in position from dynode to dynode. This results in a reduction in the transit time spread as compared to an unfocused system, and thus a shorter rise time of the anode pulse. Venetian blind types (50mm diameter) give a rise time of about 10 nanoseconds, and if a shorter rise time than this is required a tube with a linear focused structure should be chosen: the EMI type 9594 photomultiplier incorporates a 14-stage system of this type, and gives a rise time of about 2 nanoseconds.

The compact focused structure illustrated in Fig. (i)(b) is utilised in a number of side-window tubes (often referred to as "squirrel-cage" photomultipliers). Tubes of this variety are useful in applications where less stringent demands are made on the photomultiplier, and small size and low price are important. (See page 18.)

The optimum number of stages is normally determined by the gain requirement, which is in turn determined by dark current, amplifier noise and maximum anode current. EMI photomultipliers are tested at the optimum overall sensitivity and gain for the number of stages in individual tubes.

(iv) DARK CURRENT LIMITATION

It is found that the parameter given by dark current divided by gain is virtually constant over a wide range of gain but increases at high and low gains. At low gain the dark current from the photocathode is not much greater than the electrical leakage at the anode, although special precautions are taken to reduce this leakage on all EMI tubes. If the gain and anode current are high, ionisation of the residual gas may occur, and the resulting light is detected by the photocathode, causing a spurious increase in the anode current. Ultimately the anode current increases due to this positive feedback until it is limited by the dynode chain or by saturation. This limiting current is frequently sufficient to cause permanent damage. In general, photomultipliers with a large number of dynodes have a longer feedback path and so are less susceptible to this effect, which is one reason why they are recommended for high gain applications.

There is also the limitation of flashover between electrodes at excessively high overall voltages.

It is quite clear that it is advantageous to use a multiplier which gives high gain at relatively low operating voltages. Such behaviour is characteristic of the EMI CsSb dynode systems.

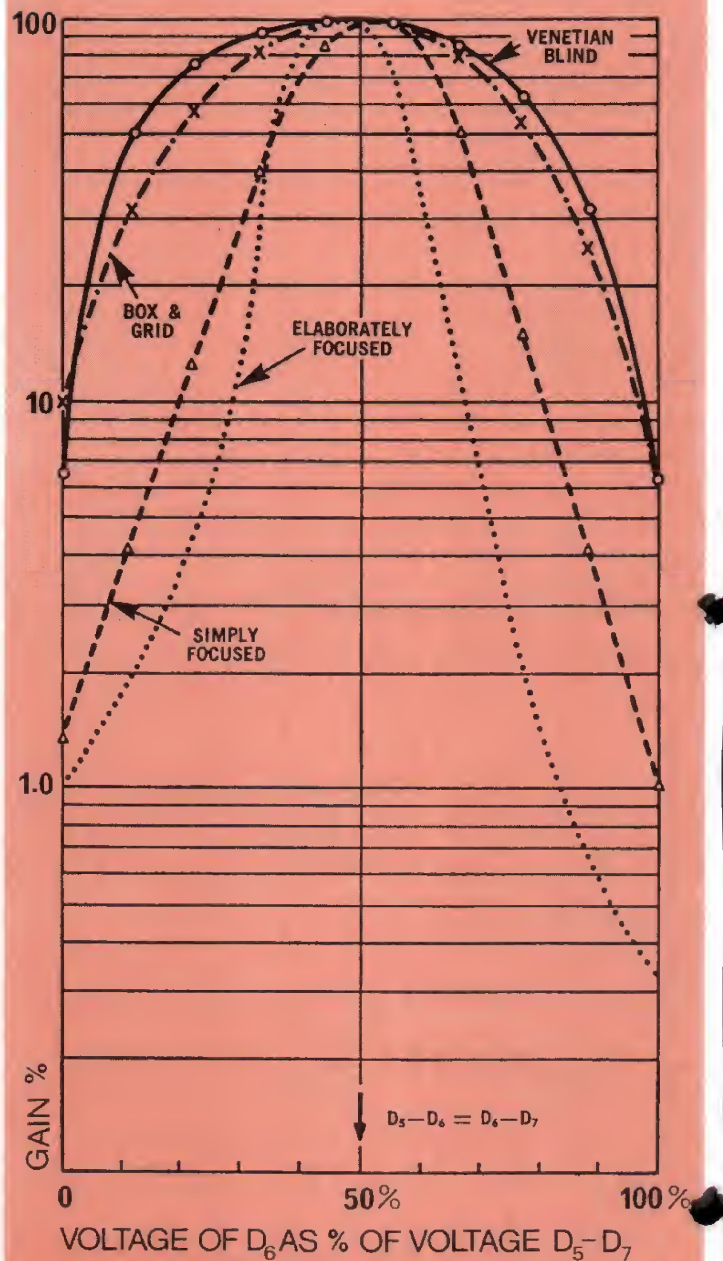

Fig (ii) Curves showing variation in tube gain as dynode No. 6 is varied in potential between D₅ and D₇

In Section 2(v) some attention was given to the technique of virtually eliminating the thermal dark current component by cooling the photomultiplier to about -40° C. It should also be mentioned that since dark current is approximately proportional to photocathode area, small diameter cathodes may be chosen, where possible, to minimise dark current.

(v) NOISE LIMITATION

In order to understand how noise occurs at the output of photomultipliers one must remember that the signal arriving at the photocathode is a beam of photons, usually randomly distributed with time. Some of these produce photo-electrons, most of which are multiplied. The photomultiplier is such a very good amplifier that the statistical fluctuations in the input signal are not smoothed out.

As an example consider a photomultiplier operating at a gain of 3×10^7 . A mean anode current of $10^{-9} A$ (which is easily measured) corresponds to a cathode current with a mean value of $3.3 \times 10^{-17} A$ or about 200 electrons/second. This would be produced by a beam of 800 photons/second if the photocathode quantum efficiency was 25%. One can apply Poisson's formula in statistics in this case and so, if n_o is the mean number of photo-electrons emitted in a time τ , the standard deviation, σ , of this number is given by $\sigma^2 = n_o$. Now from the definition of standard deviation, the root mean square of the distribution of the number of photo-electrons emitted in time τ is σ . If τ is 0.5 sec. in the above example, $n_o = 200 \times 0.5 = 100$, so $\sigma = \sqrt{n_o} = 10$. If I_K is the mean photocathode current, $n_o = \frac{I_K \tau}{e}$, so $\sigma = \sqrt{\frac{I_K \tau}{e}}$. However, when there is a photocathode dark

current of mean value I_d present the root mean square variation due to this is $\sqrt{\frac{I_d \tau}{e}}$ and the total r.m.s. variation is $\sqrt{\frac{(I_d + I_K) \tau}{e}}$.

One can see from this the significance of stray light and dark current even when the direct current effects have been backed off or eliminated by chopping.

If one now talks in terms of frequency response or bandwidth (Δf) instead of sampling time, one performs a Fourier Transform and replaces τ with $\frac{1}{2\Delta f}$ to obtain the well known formula for shot noise:

$$i_{ks} = \sqrt{2eI'_K \Delta f} \quad (11)$$

where i_{ks} is the r.m.s. shot noise current due to total mean cathode current I'_K .

It should be pointed out that this transformation assumes zero response outside the passband Δf and is invalid at frequencies approaching $\frac{1}{2 \times (\text{transit time spread})}$.

For an amplifier with gain A_o at d.c. and $A(j\omega)$ at an angular frequency ω , $\Delta f = \frac{1}{A_o} \int_0^\infty |A(j\omega)| d\omega$, if the passband falls off at 6dB/octave (for example with a parallel CR filter), Δf is $\pi/2$ times the frequency at which the voltage response is reduced by 3dB.

Secondary emission amplification cannot reduce the fundamental shot noise component, so for a gain G , the ideal output r.m.s. noise current would be $G\sqrt{2eI'_K \Delta f} = \sqrt{2eGI'_A \Delta f}$ where I'_A is the mean anode current corresponding to I'_K . Statistical variations in the secondary emission coefficient (δ) at the dynodes of a photomultiplier increase the noise level above this value. The increase is mostly due to the first stage. A noise enhancement factor a must therefore be introduced into the shot noise formula and the r.m.s. noise current at the output becomes $a\sqrt{2eGI'_A \Delta f}$.

It can be shown that $a = \sqrt{\frac{1}{f} \left\{ 1 + \frac{1}{g_1 \delta_1} + \frac{1}{g_1 \delta_1 (g\delta - 1)} \right\}}$ where the notation is the same as section 2 (iv) and $g_1 \delta_1$ is the gain of the first dynode.

In the example, in a bandwidth of 1 Hz the r.m.s. shot noise current at the cathode due to the signal is $\sqrt{2 \times 1.6 \times 10^{-19} \times 3.3 \times 10^{-17} A} = 3.3 \times 10^{-18} A$. The noise current at the anode is $3 \times 10^7 \times 3.3 \times 10^{-18} = 10^{-10} A$ if a is assumed to be 1.0.

The noise current in the anode load resistor due to Johnson noise is $\frac{4kT}{R} \Delta f$ where R is the resistance in ohms, k is Boltzman's constant and T is the temperature in K.

$$\begin{aligned} \text{Hence the total noise current is } & \sqrt{(2a^2 eGI'_A + \frac{4kT}{R}) \Delta f} \\ & = \sqrt{\frac{e}{R} (2a^2 RGI'_A + \frac{4kT}{e}) \Delta f} \quad (12) \end{aligned}$$

Now at 300 K, $\frac{4kT}{e} = 0.1$, so, if the noise from the anode load resistor is to be negligible, $2a^2 RGI'_A \gg 0.1$; so $G \gg \frac{0.1}{2RI'_A}$ (if $a \sim 1$).

Typical values of f , $g_1 \delta_1$ and $g\delta$ are given in Table 2, together with the corresponding values of a . An indication is also given of the K-D1 voltage needed to give the particular values of $g_1 \delta_1$ for a 50 mm diameter tube with venetian blind CsSb dynodes. It will be seen that unduly low values of $g_1 \delta_1$ may give rise to a serious degradation of the signal to noise properties.

TABLE 2

f	$g_1 \delta_1$	$g\delta$	a	K-D1 Voltage
0.90	6	4	1.16	200
0.85	4	4	1.29	100
0.80	3	3	1.36	75

Thus for best values of signal to noise ratio a tube with high cathode sensitivity should be selected, and should be operated with a high first stage gain. This may be contrived by applying the recommended stabilised voltage between cathode and first dynode (see page 14). In general, measured values of signal to noise ratio agree well with theoretical prediction.

(vi) CURRENT LIMITATION

(a) Cathode Current

The limits to the magnitude of the cathode current are set by cathode resistivity. This can result in a voltage drop across the cathode which weakens the K-D1 field and impairs collection efficiency. Also, Ri^2 heating of the cathode material can result in deleterious effects on cathode performance at excessive values of current. The standard Cs₃Sb-O S-11 cathode has a high resistivity, and the maximum cathode current density which may be obtained from it without adverse results is about $0.02 \mu A/cm^2$ (when the tube is run as a diode at 450V). Tubes with 10 mm diameter cathodes and short K-D1 geometry have a significantly higher collecting field and are therefore less prone to this effect. Tubes of this variety (EMI types 9502 and 6256) show good saturation to currents of $3.5 \mu A/cm^2$ when operated as diodes at 450V.

Most tubes with trialkali (S-20) cathodes show good saturation up to several $\mu A/cm^2$ due to the lower surface resistivity of the cathode material (EMI types 9558 and 9698). It should be emphasised that such currents should not be drawn from the cathodes of photomultipliers where considerations of last dynode and anode dissipation supervene. It should be remembered that semi-transparent cathode materials are, in fact, semi-conductors, and that their resistivities increase (markedly in some cases) at low temperatures. This enhances the effects outlined above. Due note should therefore be taken of the minimum operating temperature for a particular tube type.

(b) Anode Current

The limits to the anode current are set by the maximum tolerable anode dissipation (see Section 5), dynode heating, and space charge effects. Dynode heating occurs at the final dynodes for excessive values of current. This results in a drop in the value of the secondary emission coefficient for these dynodes, and a consequent drop in gain. Heating may also result in the redeposition of caesium with disastrous effects for the tube. Space charge effects will occur at high peak anode currents especially if the collecting potential gradient is reduced by the dynode currents being of the same order as the dynode chain current. They can be minimised by correct design of the dynode chain (see Sections 5, 6 and 7).

(vii) ENVIRONMENTAL LIMITATIONS

(a) Vibration

Photomultipliers are sometimes required which will survive a period of intense vibration (e.g. in a rocket launch) and operate efficiently afterwards. Such tubes of specially rugged construction are available from EMI Electronics Ltd., and are vibration tested as part of the normal acceptance procedure. (See page 59.)

(b) Magnetic Fields

The output of a photomultiplier is severely affected by environmental magnetic fields in a fashion shown in Fig. (iii).

The effect is particularly important in the region between cathode and first dynode.

The use of an appropriate mu-metal shield (see page 64) maintained at cathode potential, is a straightforward way of minimising it.

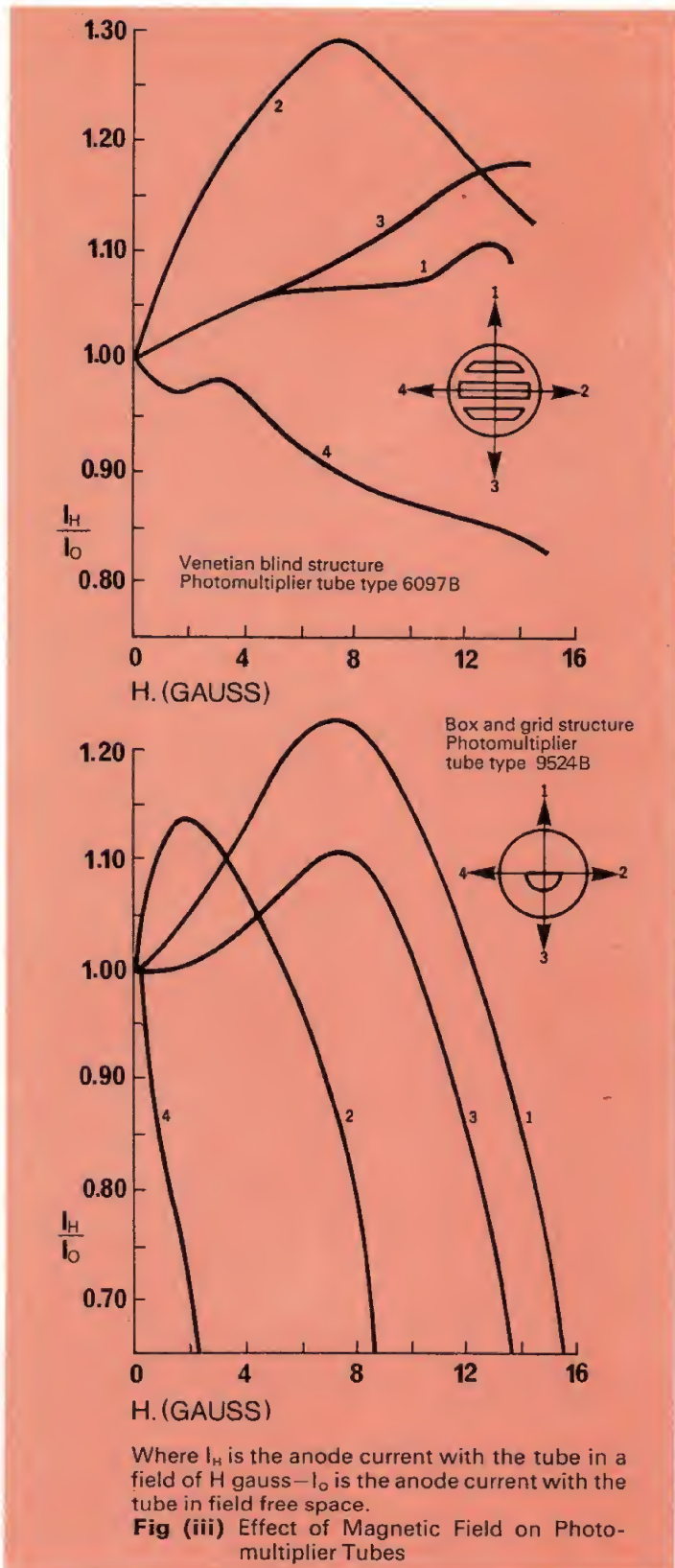

(c) Electrostatic Fields

It is vitally important that nothing should touch the tube envelope which will disturb its potential stabilisation. Any material in contact with the envelope should be at cathode potential. A mu-metal shield properly connected performs the dual function of an electrostatic shield and a magnetic shield.

(d) Radioactive Sources

It is obvious that if a tube is operated in proximity to intense radioactive sources there will be a considerable contribution to the tube background from Cerenkov photons and fluorescence. Shielding appropriate to the environmental radiation should therefore be incorporated in the tube housing.

(e) Temperature Limitations

Almost all photomultipliers contain caesium and if the temperature of the tube exceeds about 60°C redeposition of the caesium will occur with disastrous effects. Therefore this temperature should not be exceeded. Furthermore, the dark current is a very critical function of temperature so operation of photomultipliers above room temperature will result in increased dark current.

The low temperature limitation is due to the resistance of the photocathode, although there is a considerable variation between individual tubes. When cooling it is important to avoid thermal shock to the envelope, particularly if a quartz window is fitted. When cooling below -40°C , the standard Teflon socket should not be used as it may deform and crack the glass. Instead, each pin should be connected separately and individual hyperboloidal contacts are available from EMI for this purpose.

A range of cooled photomultiplier housings are also available for reducing dark current to a minimum.

(f) Vacuum:

The force due to the atmospheric pressure on the window of a 50 mm photomultiplier is about 45 lb.f. and this imposes considerable strain on the envelope. Therefore, if photomultipliers are placed in an evacuated chamber, care should be taken that the rate of change of pressure is not excessively fast.

4. Pulse Counting

It has been indicated already that a photomultiplier detects light quanta and produces pulses of charge proportional to the number of photons interacting in the sampling time. Optimum information is obtained by analysing the distribution of output pulses. This is normally done using counting techniques and in particular for detecting nuclear events which usually produce a substantial number of photoelectrons, although the technique may be used for very low light levels. Typical curves for a tube are illustrated in Fig. (iv). The differential curve is a plot of $N(v)dv$ where $N(v)$ is the number of pulses of amplitude between amplitudes v and $v+dv$. The integral curve $\int_0^\infty N(v)dv$ against v is also known as a bias curve. These curves were obtained with a 6256 used for counting single photons, and the background has been subtracted. The curves for the background are also shown in Fig. (iv) and it is evident that there are disproportionately large number of very small amplitude and very large amplitude pulses compared with those due to single photons. The very large amplitude pulses are mostly due to radiation interacting in the window and the very small amplitude pulses are due to emission from the dynodes. It is obvious that the ratio of signal to background is greatest if the pulses at the extreme ends of the spectra are disregarded and this is why pulse counting has been an advantage over direct measurements.

5. Dynode Chain Design and Power Supply Requirements

The voltages for the dynodes of a photomultiplier are usually obtained from a chain of resistors across a high voltage source. The optimum value of these resistors depends on the application.

(i) HIGH VOLTAGE SUPPLY

(a) Supply Polarity

In order to simplify tube mounting, it is desirable that a photomultiplier should be run with the cathode grounded and the anode at a high positive potential as surfaces in contact with the envelope should be at cathode potential. With a pulsed or chopped light source this can be done using a coupling capacitor for the output signal so that subsequent electronics can be at earth potential. However, when the signal cannot be passed through a coupling capacitor, it is usually necessary to run the photomultiplier with the cathode at a high negative potential and the anode near earth potential. In this case, the precautions noted in Section 3 vii(c) should be observed.

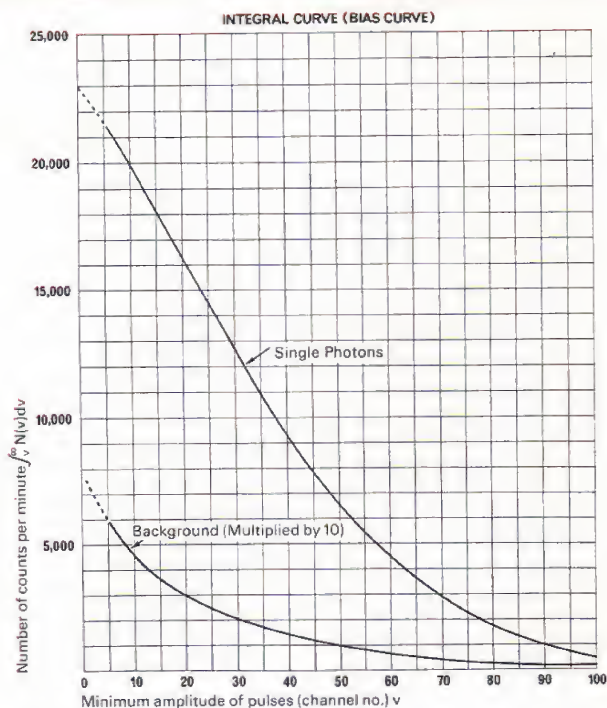
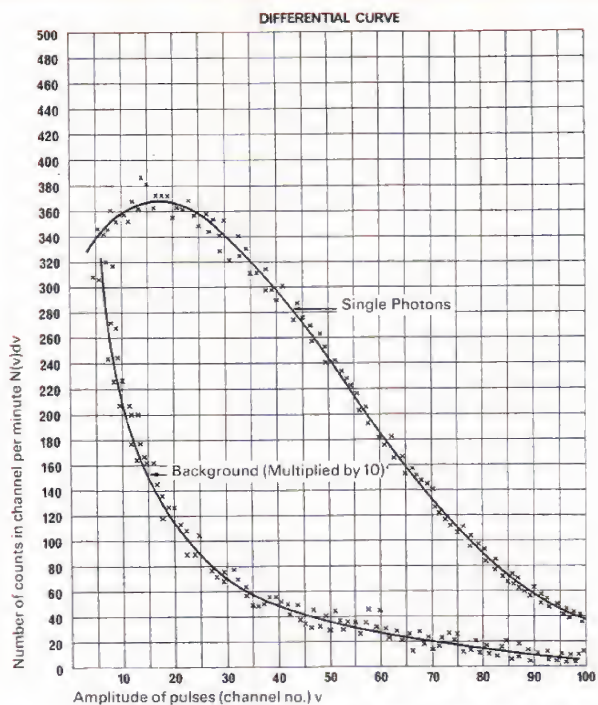

Fig. (iv) Pulse Distribution for Type 6256 Counting Photons and Background (measured over 10 minutes)

(b) Stability

The overall multiplication is extremely sensitive to the variations in the applied voltage. The output of the power supply must therefore be very stable and have a minimal ripple. If the photomultiplier is run with cathode grounded it is particularly important to ensure that ripple from the power supply is not injected into the detecting electronics.

(c) Voltage Supply Range

The overall gain of a photomultiplier is so critically dependent on the individual stage gain (see equation 4) that it is impossible for all photomultipliers, even of the same type, to have the same overall gain at a given voltage. Hence, it is essential to be able to adjust the voltage applied to the photomultiplier to take account of the differences between individual tubes. Where the sensitivity of the equipment is varied by changing the overall voltage, it is advisable to prevent the maximum overall sensitivity of the individual tube from being exceeded. This could be done using a pre-set control to limit the E.H.T. to be adjusted only when changing the photomultiplier.

(d) Chain Current

The current through a dynode chain should be at least ten times the anode current, otherwise the dynode voltages will not remain constant. However, the dynode chain resistors are usually placed close to the base of the photomultiplier. If the chain current is large, the heat dissipated will warm the tube causing an increase in the dark current and possible variations in the gain performance. Therefore, excessive current is undesirable unless the resistors are well away from the tube. For most types of EMI photomultipliers, the mean anode current should not be much more than $100 \mu\text{A}$. If the gain characteristics are to remain reasonably stable. Thus, for D.C. work, a chain current of a few milliamps is usually sufficient.

(ii) CATHODE—FIRST DYNODE

It is important that the electric field between cathode and D1 should be adequate. This is ensured by providing the recommended K-D1 voltage (page 14). The effect of magnetic fields is also diminished when this is done. Furthermore, the gain of the first dynode depends largely on this voltage and it is desirable that the first stage gain should be high. This is particularly important at low levels of illumination and high frequencies, where the statistics of photo-emission become important. In order to obtain an adequate voltage, regardless of changes in the chain current, some form of stabiliser can be used (for example a Zener diode).

A significant part of the time spread of electrons arriving at the anode after a very short light pulse is due to electrons arriving at the first dynode at different times. This time spread is reduced as the voltage is increased. Thus, for fast pulses, it is essential to operate tubes with the maximum possible cathode to first dynode voltage.

It should be noted that the gain of the first stage depends to some extent on the voltage between the first and second dynodes, so that this voltage should be maintained at not less than 100 volts in critical applications.

(iii) INTERMEDIATE STAGES

In some cases it is desirable to reduce the overall sensitivity of a photomultiplier without changing the overall voltage. A convenient method is to reduce the voltage between two adjacent dynodes in the middle of the stack; for instance D4 and D5. If further reduction in sensitivity is required the voltage between D6 and D7 could also be reduced. (See Fig. ii.)

(iv) FINAL STAGES

To avoid changing the gain characteristics of a tube, it is necessary to ensure that the mean anode current, averaged over a period of about half a minute, does not exceed the maximum value stated in the data sheet. It is desirable to keep the current well below this maximum value, and for best gain stability, it should be one hundred times lower or even less. To avoid permanent damage, precautions should be taken to prevent photomultipliers from being exposed to ambient light levels while the high voltage is switched on.

Another limitation to the anode current is loss of linearity due to the build-up of electron space charge. This occurs at much larger currents and therefore applies only to pulsed operation. The anode of EMI photomultipliers is especially designed to minimise the effects of space charge saturation. The most critical stage therefore is that before the last dynode. As in the case of a simple diode, the saturated current varies as $(V_0)^{3/2}$. Therefore, where pulses of large amplitude occur, non-linear dynode chains should be used which provide higher voltages on the last stages.

The optimum voltage distribution depends on the peak anode current and the tolerable departure from linearity; typical distributions are indicated in the table on page 14. For the venetian blind structure with 120 volts between dynodes there is a 10% departure from linearity when the peak anode current is 8 mA and a 50% departure when it is 20 mA. For the box and grid structure

the corresponding currents are 0.5 mA and 1.2 mA. These currents could be more than doubled by doubling the voltages on the last few stages. However, where non-linear dynode chains are used, the overall voltage to obtain a given overall gain must be higher than for a linear chain, and great care must be taken not to exceed the maximum rated interstage voltage.

Unless the voltage between dynodes is likely to be very low indeed, it is not necessary to use a non-linear dynode chain for D.C. measurements because the current is limited by fatigue rather than saturation.

For a venetian blind structure, there is little to be gained by raising the voltage between the last dynode and the anode above 100 volts even for very large pulses. However, care should be taken to ensure that the voltage between the anode and the last dynode is not reduced excessively by the voltage drop across the anode load resistor. By reducing the voltage between the last dynode and the anode the saturation effect can sometimes be put to good use to give a logarithmic type of output characteristic for large pulses.

The need for large chain currents when measuring large amplitude pulses can be avoided by connecting decoupling capacitors between the final stages and earth. Then the chain current need only be sufficient for the mean anode current and recharging the capacitors. The minimum size of these capacitors can be calculated if the pulse amplitude and duration are known, but it is also necessary to know the repetition rate if the minimum chain current is to be calculated. Care must be taken however that excessive voltages do not occur between adjacent electrodes when the high voltage is switched on, because initially the capacitors are virtually short circuits and the whole voltage is applied across the resistors which are not decoupled. For example, in Fig. (v)a, if the output of the E.H.T. supply reaches its full value instantaneously when it is switched on, the anode will rise to the E.H.T. potential with a time constant $(C_c + C_L)R_L$ sec. and D10 will rise with a time constant $0.05 \times 10^{-6}R$ sec. If these time constants differ by more than a factor of four, half the full E.H.T. voltage will be applied between D10 and the anode.

6. Design Procedure for Dynode Chains

In order to design a dynode chain it is necessary to define the operating requirements for the photomultiplier. This involves a knowledge of the input (light) signal and the output (electrical) signal which is frequently not available, particularly as light intensity is not easily measured. Thus it is sometimes necessary to use the photomultiplier, with a dynode chain which is not ideal, in order to obtain information to design the dynode chain properly. The simplified design procedure given on page 14 may then be used for this. If a preliminary measurement of the light intensity is being made, the intensity is calculated by dividing the measured anode current by the overall sensitivity at which the tube is operated.

Having determined what the photomultiplier is required to do one should check that this is within the capability of the tube, bearing in mind such limitations as dark current, statistical noise, maximum anode current and maximum rated sensitivity. If the application requires that the overall sensitivity must be changed by changing the overall voltage (V), the necessary maximum and minimum values of G must be known. In addition the linearity and stability required should be specified. Where the signal is in the form of a light pulse the maximum amplitude, duration (t), and repetition rate (N) for the specified linearity should be known.

(a) Power Supply

V is approximately proportional to V_s , so, substituting (5) in (4) and differentiating:

$$\frac{dG}{G} = 0.7n \frac{dV}{V} \quad (13)$$

For most photomultipliers $0.7n$ is just less than 10, so as a rough guide, the stability of the power supply should be ten times better than that specified for the application.

If a photomultiplier is run with its cathode grounded, the ripple from the power supply is injected through the anode load resistor and coupling capacitor into the measuring circuit. Therefore, if a

chopped light source is used, the chopping frequency should be different from the frequency of the ripple and its harmonics. To avoid the expense of stringent filtering and smoothing, it may be better to accept the slightly more complex mounting requirements mentioned in Section 3 vii (c) and to run the photomultiplier with its anode near ground, for this type of signal. Of course, the ripple must be small enough not to affect the overall gain significantly.

Knowing the light intensity at the photocathode, the value of gain necessary to give the required output signal can be calculated, and the corresponding overall sensitivity can also be calculated using equation (7) and the photocathode sensitivity. The overall operating voltage or voltage range can be found from the overall sensitivity versus overall voltage curves on the data sheet. Alternatively, one can use the expression:

$$\log 10 \frac{V}{V_1} = \frac{1}{0.7n} \log 10 \frac{G}{G_1} \quad (14)$$

where V_1 is the value of V corresponding to G_1 and is known. This equation is derived by integrating (13) and assumes a linear dynode chain. It is especially useful when designing a dynode chain for an individual photomultiplier because the figures from the test ticket which accompanies the tube can be used directly.

In applications where the gain of the photomultiplier is to be varied, the maximum and minimum overall voltages at which the tube is required to operate are denoted V_{max} and V_{min} ; the dynode chain current is a minimum when $V = V_{min}$, and even then it must be much more than the maximum mean anode current (I_a) max. The maximum current from the power supply will be $V_{max}/V_{min} \times$ (the minimum dynode chain current) if the dynode chain is purely resistive.

The results so far are approximate, but they are needed for further calculations from which improved values can be obtained. However, a check should be made at this stage to see if the tube ratings are likely to be exceeded.

(b) Cathode—First Dynode Voltage

If there is a large variation in V , the variation in the voltage between cathode and first dynode will be correspondingly large, resulting in a departure from the recommended values given on page 14. As a rough guide, stabilisation is desirable if V_{min}/V_{max} is less than 2/3. High voltage Zener diodes are particularly suitable for this purpose.

(c) Final Stages

Initially, one can consider a uniform dynode chain of $n+1$ resistors, each of R ohms, through which a current I flows. When there is no anode current, clearly

$$I = V/(n+1)R \quad (15)$$

If, however, a D.C. anode current I_a flows which is small compared to I , the voltage across the last chain resistor falls from IR to $(I-I_a)R$. Consequently, the voltage between the cathode and the last dynode is increased by I_aR , a fractional increase of I_a/nI . From (14) the overall gain increases by a factor $0.7 I_a/I$, as the voltage between the last dynode and the cathode is proportional to the overall voltage. Similarly, the voltage across the penultimate resistor will fall and this will give a further though smaller increase in gain. Thus one can assume for a linear dynode chain that the overall gain increases by a factor of I_a/I . In other words, when $I = 100 I_a$ the departure from linearity will be ca 1%.

Now if the value of the last chain resistor had been $R/2$, the voltage change would have been $I_aR/2$ and the increase in the overall gain due to this stage would have been only about $0.35 I_a/I$. On the other hand, if the power supply has a protective resistor, R_s , in series with its output, the increase in overall gain becomes $0.7 I_a/I \times (R+R_s)/R$ instead of $0.7 I_a/I$. The above method of reducing the chain current is not suitable for pulsed applications and an alternative is to replace the last resistors with Zener diodes, although analysis then becomes quite complicated.

The approach outlined above also applies for pulsed signals:

$$\text{where } I_a = i_a N t \text{ (} i_a \text{ is the anode current pulse)}$$

$$N \text{ is the pulse rate and } t \text{ is the pulse duration}$$

Once the maximum value of I_a is known the minimum value of I can be calculated.

It is now necessary, for pulsed systems, to determine whether the linear dynode chain, which has been considered up till now, will be satisfactory or whether saturation will necessitate the use of one of the non-linear chains given on page 14. The linearity figures given in Section 5 (iv) are of use here. However, the maximum inter-stage voltage frequently limits the choice available.

(d) Decoupling Capacitors

It is undesirable to decouple the last dynodes only to the power supply in case there is an internal protection resistor. One method is to decouple the last dynode to ground and to decouple the others to it. This only requires one high voltage capacitor. The minimum values of the decoupling capacitors are determined by the maximum charge pulse or alternatively the peak anode current and the duration of the longest pulse, since the gain must remain virtually the same at the end of a pulse as at the beginning of it. For the last stage, the fluctuation in voltage will be slightly less than $i_a t / C$, where C is the decoupling capacitance, so the fractional change in gain will be about $0.7 i_a t / CV$. Therefore, if a linearity of $L\%$ is required, then C is determined by the requirement:

$$C > 70 n i_a t / V_{min} L \quad (16)$$

The currents at the other dynodes will be smaller so the decoupling capacitors can be reduced correspondingly.

Having discovered what form the dynode chain will have to take it is now possible to make a more accurate assessment of the overall voltage. Where one stage is fed with a stabilised supply, a constant gain can be assumed for that stage and calculations may be performed as if the photomultiplier had one stage less. The other calculations may have to be repeated using the improved results for the voltage. Finally, a check should be made to ensure that the maximum ratings have not been exceeded.

7. Output Circuit

The output of a photomultiplier is electric charge and, in most applications, this charge is allowed to flow through the load resistor (R_L) while the voltage across it is measured. Sometimes a charge sensitive amplifier is used. The electrons flowing into the anode give a negative output signal, but one can obtain a positive signal, about $\frac{1}{4}$ of the anode signal, across a load resistor in series with the last dynode. This is due to electrons going to the anode, so that the voltage across the last stage must be adequate. In addition, when a signal voltage is developed across a load resistor in series with the last dynode, the voltage between the last dynode and the previous one will change, increasing the gain. The voltage between these dynodes must, therefore, be considerable if the change in gain is to be negligible.

For D.C. purposes the anode of a photomultiplier, but not the last dynode, is almost an ideal current generator and it will behave as such even when producing an output voltage of tens of volts. Therefore, high load resistors may be used if desired. Galvanometers and electronic ammeters may be connected directly to the anode, and no load resistor should be used.

For high frequency A.C. signals, the capacitance (C_L) of the anode circuit to ground is important since it shunts the anode load resistor (R_L). The voltage across this resistor will be reduced by 3 dB at a frequency $\frac{1}{2\pi C_L R_L}$ Hz and a 1% reduction will occur at a frequency

$\frac{0.141}{2\pi C_L R_L}$. To obtain an adequate frequency response, it may be necessary to reduce the value of R_L and increase the gain from the photomultiplier correspondingly.

If $C_L = 100$ pF (corresponding to a few feet of coaxial cable) the maximum value of R_L for a response which is 1% down at 1 KHz is given by:

$$\frac{0.141}{2\pi \times 10^{-10} R_L} = 10^3$$

$$\text{So } R_L = \frac{0.141}{2\pi} \times 10^7 \text{ ohms} = 2.25 \times 10^5 \text{ ohms.}$$

For pulses of short duration, the capacitance (C_L) of the anode circuit to ground is also important. If the charge or current pulse is much shorter than the anode time constant, $C_L R_L$, the current is simply charging a capacitor, so the output voltage pulse is proportional to the product of $1/C_L$ and the charge. After the pulse the voltage decays exponentially with the time constant $C_L R_L$. The maximum value for $C_L R_L$ is determined by the requirement to prevent pulses piling up on each other: $C_L R_L \ll N^{-1}$.

The electrons arriving at the anode of a photomultiplier after a very short flash of light do not do so simultaneously, but with a time distribution which is roughly Gaussian. One can assign a standard deviation, τ_2 sec, to this and the pulse width at half maximum amplitude, which is often called the time spread, is then $2.36\tau_2$ sec. The equation for the current pulse at the anode produced by p photoelectrons, generated in a time, t , short compared with τ_2 is:

$$i_a = \frac{Gpe}{\tau_2 \sqrt{2\pi}} \exp. \left[-\frac{1}{2} \left(\frac{t}{\tau_2} \right)^2 \right] \quad (17)$$

where e is the charge on an electron.

The output voltage v_a is given by:

$$i_a = \frac{v_a}{R_L} + \frac{C_L dv_a}{dt} \quad (18)$$

If $C_L R_L \gg \tau_2$, the peak output voltage would be Gpe/C_L , but if $C_L R_L = \tau_2$ the peak output voltage would be reduced to one third of this value.

In many applications, the light input signal rises very rapidly, and then falls away exponentially with a time constant τ_1 .

If τ_1 is much longer than τ_2 , the peak current is Gpe/τ_1 , but if $\tau_1 = \tau_2$ it is only one third.

If τ_2 is short compared to τ_1 , but $C_L R_L = \tau_1$, the signal voltage is again less than it would be if $C_L R_L \gg \tau_1$.

8. Luminous Flux

A source with an emission spectrum $W(\lambda)$ gives rise to a luminous flux of dF lumens in the wavelength region λ to $\lambda + d\lambda$ where:

$$dF = 682 \cdot V(\lambda) \cdot W(\lambda) \cdot d\lambda$$

in which $W(\lambda)$ is the emission spectrum of the source in watts/unit wavelength interval.

682 Lumen watt⁻¹ is the luminous efficiency of light at 5550Å (the wavelength of peak response (foveal) of the C.I.E. standard eye) and $V(\lambda)$ is the relative response of the C.I.E. standard eye.

Thus, the total luminous flux from the source $W(\lambda)$ is given by:

$$F = 682 \int_0^\infty V(\lambda) W(\lambda) d\lambda \text{ lumens}$$

Now for a standard tungsten source with an emission spectrum $W(\lambda)$ the current from a photosensitive surface irradiated by the flux would be:

$$i_k = 10^3 \int_0^\infty E(\lambda) W(\lambda) d\lambda \mu A$$

$E(\lambda)$ is as in Section 2 (ii)

so that the cathode sensitivity in $\mu A/\text{lumen}$, (S) is given by:

$$S = \frac{10^3 \int_0^\infty E(\lambda) W(\lambda) d\lambda}{682 \int_0^\infty V(\lambda) W(\lambda) d\lambda}$$

Given calibrated values of $E(\lambda)$ for a particular tube, and using tabulated data for the emission of a black body at 2857°K and the function $V(\lambda)$, S may be evaluated using a technique of numerical integration. Good correlation is obtained between calculated and measured values of S .

The statement of cathode sensitivity in $\mu A/\text{lumen}$ makes it difficult to compare two cathodes having appreciably different spectral responses. In particular, the fact that the emission spectrum for a 2857°K black body peaks at a wavelength of 1 micron may result in a disproportionate increase in photosensitivity for a small extension of the long wavelength threshold.

Acknowledgements

Some of the information for this article has been drawn from the following publications, to the authors of which due acknowledgement is made:

- (1) The various works of Mr. J. Sharpe, Managing Director, Electron Tube and Microelectronics Division, EMI Electronics Ltd.
- (2) "Photocathodes used in photomultiplier tubes for scintillation counters" by V. A. Stanley, Electron Tube and Microelectronics Division, EMI Electronics Ltd., I.E.E.N.S. Transaction, 10th Scintillation Counter Symposium, Washington, March 1966.
- (3) "Fatigue and Saturation in Photomultipliers" by J. P. Keene, Rev. Sci. Inst., 34, 11, 1963.
- (4) "Studies of the Photoemission of Semiconductors" by M. Berndt and P. Gorlich, Phys. Stat. sol. 3, 963 (1963).

Figures (iii) and (iv) are reproduced from "Photoelectric Cells and Photomultipliers" by J. Sharpe, Electronic Technology, June and July 1961.

The table of Zener diodes is printed with the kind permission of Motorola Semiconductors Ltd. and Texas Instruments Ltd.

Reprints of most of the papers of Messrs. Sharpe and Stanley are available from EMI Electronics Ltd., on request, together with several other papers dealing with specialised aspects of photomultipliers, and would serve as a suitable source of further reading.

Dark Current Shot Noise Equivalent Inputs

The values quoted in the specifications are the typical equivalent input noise power and luminous flux to be expected when no light is incident on the photocathode. When the signal current is ten times the dark current, this component of noise may be neglected.

The r.m.s. shot noise in Amps at the cathode (i'_{ks}) due to the dark current is calculated using equation 11,

$$\text{with } I'_k = 10^{-6} \times \frac{S}{M} \times (\text{anode dark current})$$

(see equation 7). The luminous intensity equivalent to the dark current shot noise is obtained by dividing i'_{ks} by $S \times 10^{-6}$. The power in watts equivalent to the dark current shot noise may be obtained by dividing i'_{ks} by $(E(\lambda) \times 10^{-3})$ where $E(\lambda)$ is calculated from equation 2 with $Q(\lambda)$ and λ taken for the peak response (Table 1).

A bandwidth of 1 Hz is assumed for convenience and the enhancement factor a is assumed to be unity.

Time Characteristics

The anode pulse rise time is the time for the output pulse to rise from 10% to 90% of the peak output when the tube is illuminated by a flash of light of very short duration.

The anode pulse f.w.h.m. is the full width of the output pulse measured at half maximum amplitude.

The transit time is the time between the arrival of the flash of light at the photocathode and the time when the output pulse is a maximum.

In each case the complete photocathode is illuminated using a point source above the centre of the photocathode at a distance equal to the diameter of the tube. Measurements referred to in the data were made at the maximum rated overall voltage.

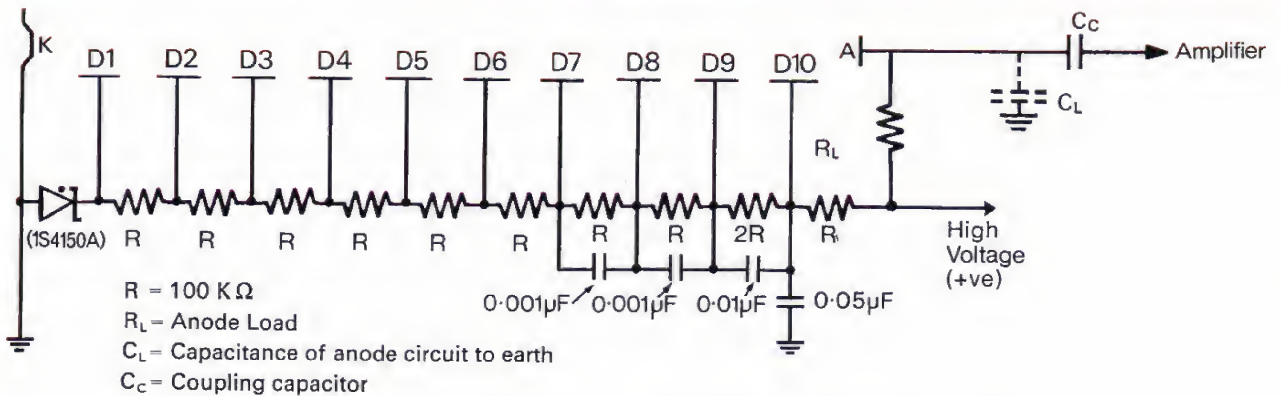

Fig. (v) a. Photomultiplier Standard Dynode Chain (e.g. 9656 used in scintillation counting).

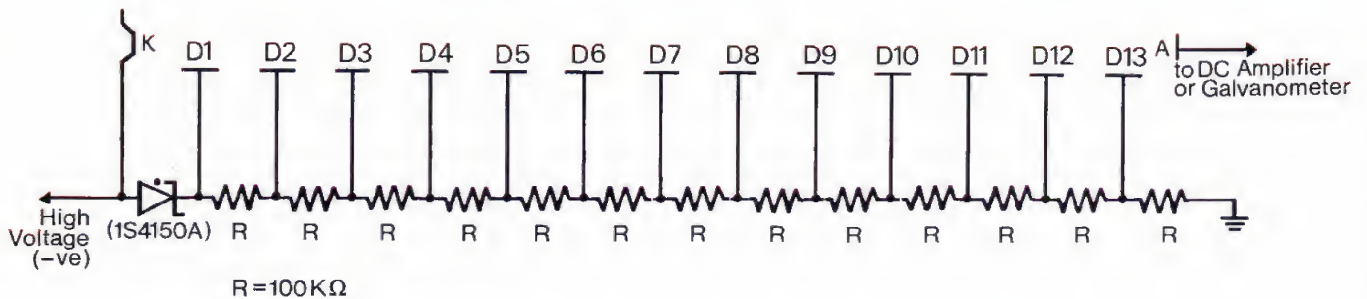
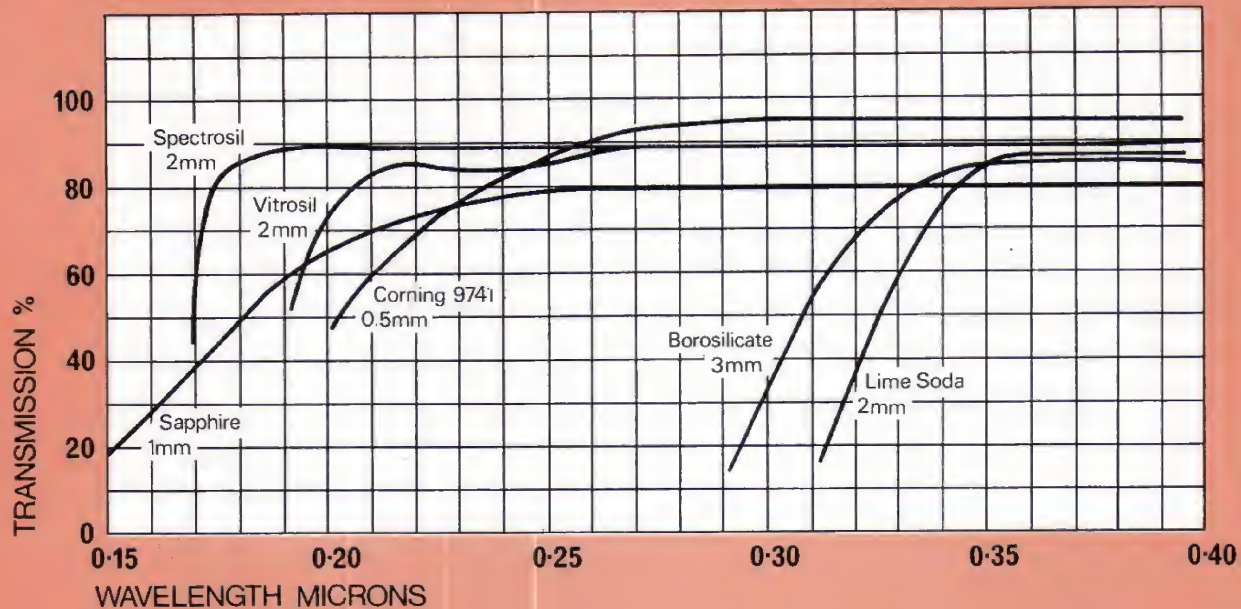
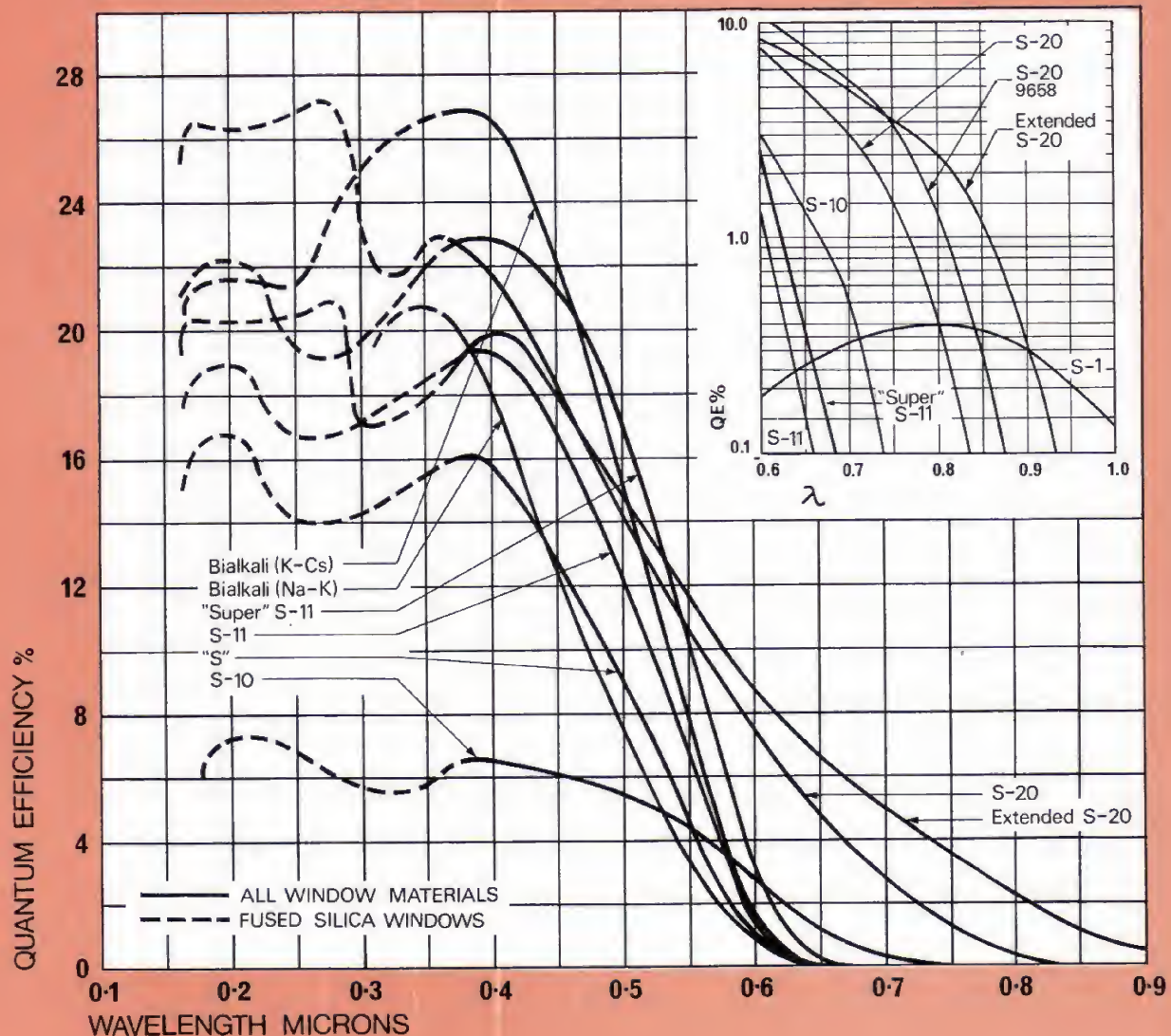

Fig. (v) b. Photomultiplier Linear Dynode Chain (e.g. 6256 used for measuring steady light signal).

UV Transmission of Typical Photomultiplier Windows



Typical Spectral Response Curves for EMI Photocathodes (50 and 30 mm diameter tubes)



Simplified Design Procedure for Dynode Chains

This design procedure will be satisfactory in applications which are not critical. For more exacting applications it is useful as a preliminary design but reference should also be made to the appropriate notes in the Introduction and to Fig. (v) a and b (page 12).

1. Select a suitable dynode chain from the table below. For most applications the "standard" chain may be used but for d.c. measurements the linear chain is satisfactory. For many applications 100 K Ω resistors will be suitable, but in general the chain current should be ten times the mean anode current.
2. Select the required number of Zener diodes to stabilise the voltage between cathode and D1.
3. For pulsed applications, the last dynode should be decoupled to ground with a 0.1 μ F capacitor and the next two dynodes decoupled to it with 0.01 μ F capacitors.
4. The value of the load resistor (if needed) is normally determined by the subsequent circuitry but for fast pulses it may be limited by the anode time constant $C_L R_L$.
5. If possible, determine the overall operating voltage. If it is anticipated that the tube will be operated at the overall sensitivity specified on the test ticket supplied with the tube, the given voltage can be used directly. If it is anticipated that the tube will be operated at another overall sensitivity, the appropriate voltage can be obtained from the overall sensitivity versus overall voltage curve in the data sheet. The point corresponding to the test ticket information is plotted and the curve for the particular tube is sketched in; the voltage is then taken from this.
6. Calculate the dynode chain current at the expected operating voltage and verify that the voltage and current are within the capability of the E.H.T. supply. If the chain current exceeds the capacity of the supply it will be necessary to increase the values of the chain resistors.
7. If the intensity of the light is not known, the overall voltage should be increased slowly when the tube is first operated and the d.c. anode current should be monitored. It should not exceed 100 μ A. The maximum rated overall sensitivity, which is often reached well below the maximum rated voltage, should not be exceeded.

Recommended K-D1 Stabilised Voltages (Unless otherwise stated in the data sheet.)

Nominal Tube diameter (mm)	K-D1 voltage
30 mm, 50 mm	150V
75 mm, 90 mm, 100 mm	300V
130 mm	450V
190 mm, 310 mm	750V

Suitable 150V (nominal) Zener Diodes (5% tolerance)

Type	Power	Test Current	Max. Impedance at Test Current
1N989B (Motorola)	400 mW	0.85 mA	1500 Ω
1N5276B (Motorola)	500 mW	0.85 mA	1500 Ω
1M150ZS5 (Motorola)	1 W	1.7 mA	1000 Ω
1N3817B (Motorola)	1.5 W	2.5 mA	700 Ω
1S4150A (Texas)	1.5 W	1 mA	1200 Ω
		2 mA	600 Ω
1N3011B (Motorola/Texas)	10 W	17 mA	175 Ω
1S6150A (Texas)	10 W	1 mA	1500 Ω
(CV 7231)		10 mA	180 Ω

N.B. When Zeners are connected in series they should each be shunted by a high value resistance, ($> 1M \Omega$).

Number Stages	Distribution	Type	Group
6 Stage	K — D1 — D2 — D3 — D4 — D5 — D6 — A		
	Stab. R R R R R R R	"Linear" Simple High Gain	A
	Stab. R R R R 2R R R	"Standard" High Gain, High Current	B
	Stab. R R R 2R 3R R	High Current	C
9 Stage	K — D1 — D2 ... D6 — D7 — D8 — D9 — A		
	Stab. R R R R R R R	"Linear" Simple High Gain	D
	Stab. R R R R 2R R R	"Standard" High Gain, High Current	E
	Stab. R R 2R 3R R R	High Current	F
	Stab. R R 2R 3R 2R	Special 30 mm Dia. High Current	F'
10 Stage	K — D1 — D2 ... D7 — D8 — D9 — D10 — A		
	Stab. R R R R R R R	"Linear" Simple High Gain	D'
	Stab. R R R R 2R R R	"Standard" High Gain, High Current	E'
	Stab. R R R 2R 3R R	High Current	F'
11 Stage	K — D1 — D2 ... D8 — D9 — D10 — D11 — A		
	Stab. R R R R R R R	"Linear" Simple High Gain	H
	Stab. R R R R 2R R R	"Standard" High Gain, High Current	I
	Stab. R R 2R 3R R R	High Current	J
	Stab. R R 2R 3R 2R	Special 30 mm Dia. High Current	J'
13 Stage	K — D1 — D2 ... D10 — D11 — D12 — D13 — A		
	Stab. R R R R R R R	"Linear" Simple High Gain	K
	Stab. R R R R 2R R R	"Standard" High Gain, High Current	L
	Stab. R R 2R 3R R	High Current	M

K — Cathode A — Anode Stab. — Stabilised Voltage

Typical Applications

Photomultiplier tubes are used for the detection of visible and near visible radiation in a wide range of applications. A brief guide to these is given in the following table which is intended to assist in a preliminary selection of tube types. Quartz variants have been included where they are supplied as standard types.

Typical Application	Standard Tube Types	Nom. Tube Dia.	
		mm	(ins)
Low Level Photometry	6094B 6094S 6256B 6256S 9502B 9502S	50	(2)
General Purpose—Photometry, Scintillation Counting, etc.	9524B 9524S 9526B 9526S 9601B 9734B 9734QB	30	(1.1)
	6097B 6097S 6255B 6255S 9514B 9514S 9634QB 9637B 9656B 9656S	50	(2)
	9708B	75	(3)
	9531B	90	(3.5)
	9732B	100	(4)
	9530B 9709B 9618B	130	(5)
	9623B	190	(7.5)
Scintillation Counting—High Energy, Good Resolution	6097L 9634QR 9637R 9656R 9750B 9750QB	50	(2)
	9708R	75	(3)
	9531R	90	(3.5)
	9732R	100	(4)
	9530R 9618R 9709R	130	(5)
	9545B	310	(12)
Scintillation Counting—Low Energy Weak Light Detecting	9635B 9635QB 9750B 9750QB	50	(2)
	9758B	75	(3)
	9791B	130	(5)
General Purpose—Photometry (Side Window Tubes)	9661B 9664B 9665B 9670B 9781B 9783B	30	(1.1)
Spectrophotometry—Extended Red Response, Laser Detection	9529B 9592B 9698B 9698QB	30	(1.1)
	9558B 9558QB 9658B 9658R 9684B 9684QB 9659B 9659QB	50	(2)
	9710B 9710TB	75	(3)
	9790B	130	(5)
Fast Coincidence Systems etc.	9594B 9594QB 9595B 9595QB 9596B 9596QB 9597B 9597QB	50	(2)
Scintillation Probes— 2π Sensitivity	9600B	30	(1.1)
	9638B 9726B	50	(2)
Space and Shock/Vibration Environments—Rugged Versions	9734NB	30	(1.1)
	9644NB 9647NB	50	(2)
	9711NB	90	(3.5)
	9712NB	130	(5)
High Temperature Environments	9700B	30	(1.1)
	9727B	50	(2)
Film Scanning	9558B 9656F 9658B 9637R 9726B	50	(2)
Mass Spectrometry—Particle Detection (Windowless Electron Multipliers)	9603/2B 9643/2B 9643/4B 9707B	50	(2)

Windowless electron multipliers

Four windowless electron multipliers are currently available from EMI as preferred types. Three are venetian blind multipliers, type 9603/2B having 15 BeCu dynodes and types 9643/2B and 9643/4B having 17 BeCu dynodes. The latter two differ in that type 9643/4B has replaceable dynodes and incorporates an internal bakeable resistor chain (2M Ω per stage Pyrofilm). Venetian blind dynode assemblies are also available in evacuated envelopes but are not wired or tested and do not include the filament.

Type 9707B utilises the box and grid system and has 17 BeCu stages. An internal bakeable resistor chain (again 2M Ω per stage Pyrofilm) is included in the assembly and the first dynode is replaceable.

A small tungsten filament is mounted in each multiplier and thermionic electrons for checking the operation of the multiplier can be produced by applying 1.5 to 2V at 1.5A to the filament. Mean currents of up to 1mA may be drawn for a short time from the anode of the multiplier. The maximum tolerable operating pressure is 10⁻⁴ torr.

The multipliers are mounted on a standard 19-pin pressed glass base, and furnished with a low loss Teflon socket type B19A. The tube envelope is of Kodial glass and, as supplied, is approximately 100 mm longer than the dynode system: it may therefore be cut at any convenient point for sealing to the vacuum system.

In addition to the standard tubes, several variants, including AgMgO types, are available to special order. Further details of these are given in the table of "Mechanical and Electrical Characteristics".

Particle detectors find application in the monitoring of vacuum UV photons and soft X-ray quanta, electrons and ions. Type 9707B is widely used for ion detection in mass spectrometer systems. Both BeCuO and AgMgO dynode multipliers are insensitive to visible radiation, having their long wavelength threshold at about 2900-3000Å.

A more detailed treatment of the performance and applications of particle detectors is given in the EMI document R/P034, available on request.

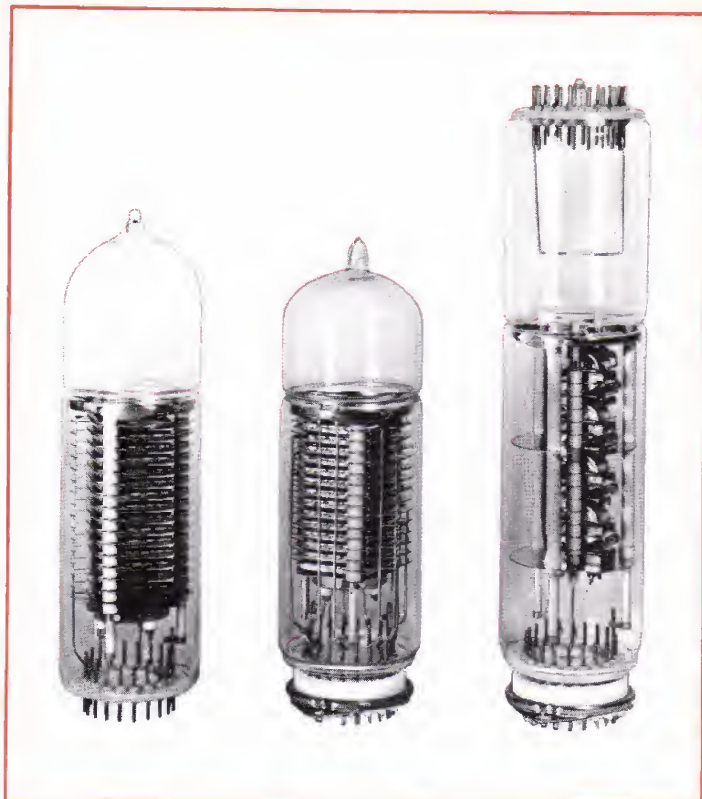

Notes

- 1 When grinding the envelope, care must be taken to avoid contamination of the dynodes by grinding fluid. The dynodes must not be heated when down to air.
- 2 The dynodes may be exposed to dry air for periods of up to 24 hours without serious detriment to the gain. Should the gain be found to be low after the tube has been let down to air, it may be restored in some cases by running an electrical discharge in oxygen through it. (See R/P034 available on request.) When not in use, windowless multipliers may be conveniently stored in a vacuum desiccator.
- 3 To minimise the effect of statistical noise it is important to have an adequate integrating time in the measuring system. (See R/P034.)
- 4 It is strongly recommended that windowless multipliers should be operated inside an appropriate mu-metal shield (type PS6B) to eliminate the effect of environmental magnetic fields.
- 5 The maximum bake-out temperature recommended is 450°C for box and grid multipliers and 400°C for venetian blind types. It should be noted that the maximum temperature for certain earlier types is 250°C.

MECHANICAL AND ELECTRICAL CHARACTERISTICS

Multiplier Type	Dynode Material	No.	Structure	Internal resistors etc.	Overall Gain		Corresponding Voltage kV
					Min.	Typ.	
Preferred Types							
9603/2B	BeCu	15	Venetian blind	—	2×10 ⁴	3.5×10 ⁵	2.5
9643/2B	BeCu	17	Venetian blind	—	2×10 ⁵	2.5×10 ⁶	2.85
9643/4B	BeCu	17	Venetian blind	Replaceable dynodes and resistors	2×10 ⁵	2.5×10 ⁶	2.85
9707B	BeCu	17	Box and grid	Resistors included, also replaceable D1	2×10 ⁵	6×10 ⁵	2.85
Variants (to special order)							
9603/1B	AgMgO	15	Venetian blind	—	2×10 ³	3.5×10 ⁴	2.5
9603/3B	BeCu	15	Venetian blind	Resistors included	2×10 ⁴	3.5×10 ⁵	2.5
9603/4B	BeCu	15	Venetian blind	Replaceable dynodes and resistors	2×10 ⁴	3.5×10 ⁵	2.5
9641/1B	AgMgO	17	Box and grid	—	2×10 ⁴	6×10 ⁴	2.85
9641/2B	BeCu	17	Box and grid	—	2×10 ⁵	6×10 ⁵	2.85
9642/1B	AgMgO	18	Venetian blind	—	5×10 ⁴	5×10 ⁵	3.0
9642/2B	BeCu	18	Venetian blind	—	5×10 ⁵	5×10 ⁶	3.0
9642/3B	BeCu	18	Venetian blind	Resistors included	5×10 ⁵	5×10 ⁶	3.0
9642/4B	BeCu	18	Venetian blind	Replaceable dynodes and resistors	5×10 ⁵	5×10 ⁶	3.0
9643/1B	AgMgO	17	Venetian blind	—	2×10 ⁴	2.5×10 ⁵	2.85
9643/3B	BeCu	17	Venetian blind	Resistors included	2×10 ⁵	2.5×10 ⁶	2.85
9741/1B	AgMgO	16	Shielded anode	—	2×10 ⁴	6×10 ⁴	2.85
9741/2B	BeCu	16	Box and grid	—	2×10 ⁵	6×10 ⁵	2.85
9741/3B	BeCu	16	Shielded anode	—	2×10 ⁵	6×10 ⁵	2.85
9741/3B	BeCu	16	Box and grid	Resistors included	2×10 ⁵	6×10 ⁵	2.85
9741/3B	BeCu	16	Shielded anode	Resistors included	2×10 ⁵	6×10 ⁵	2.85

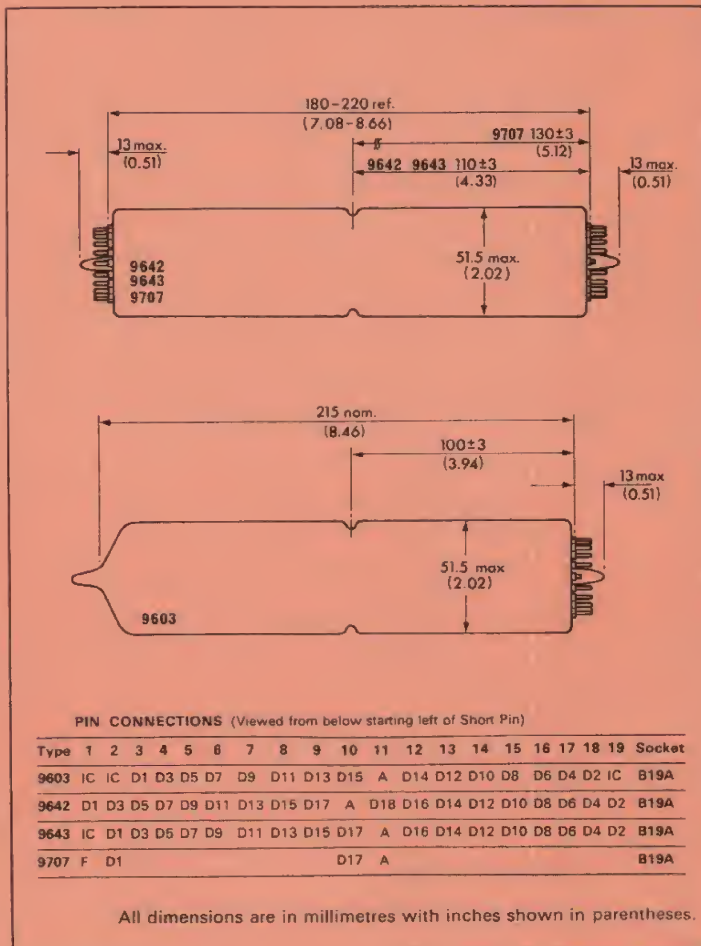
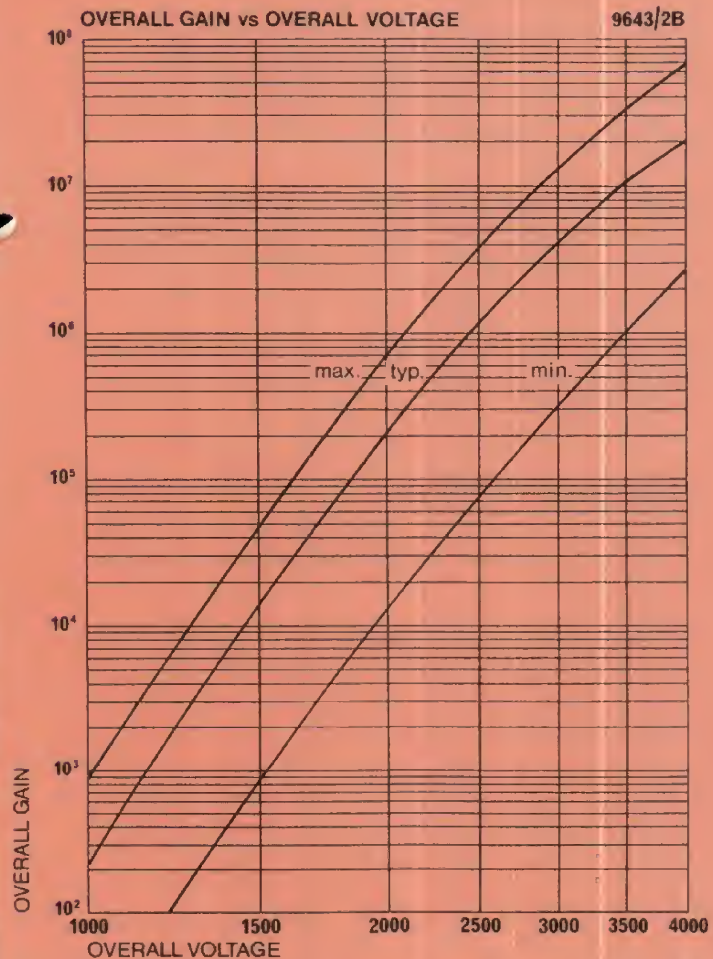
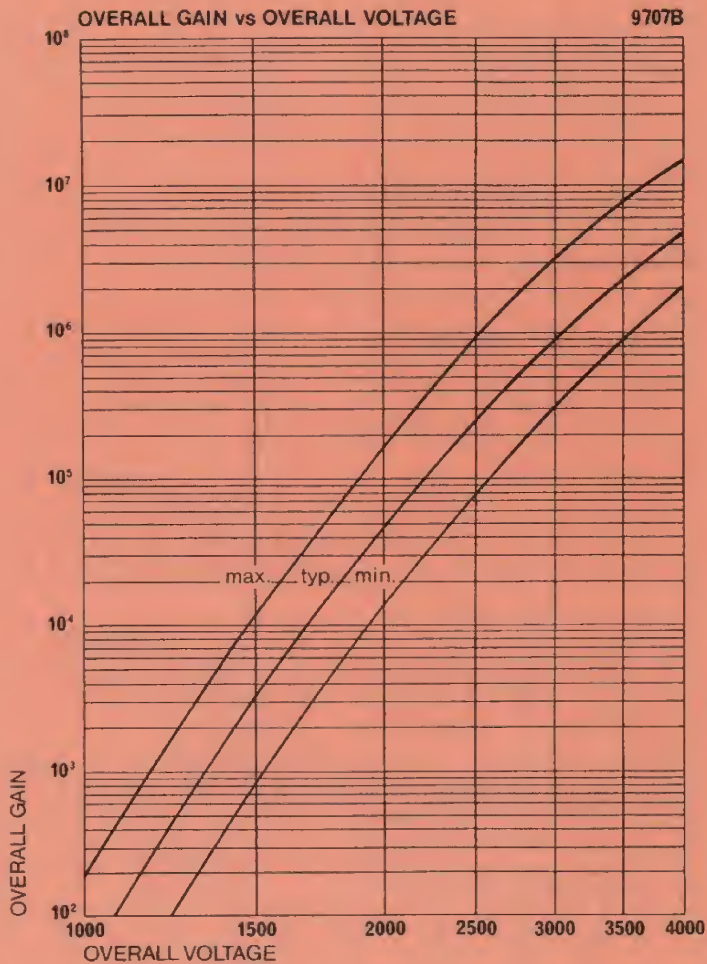
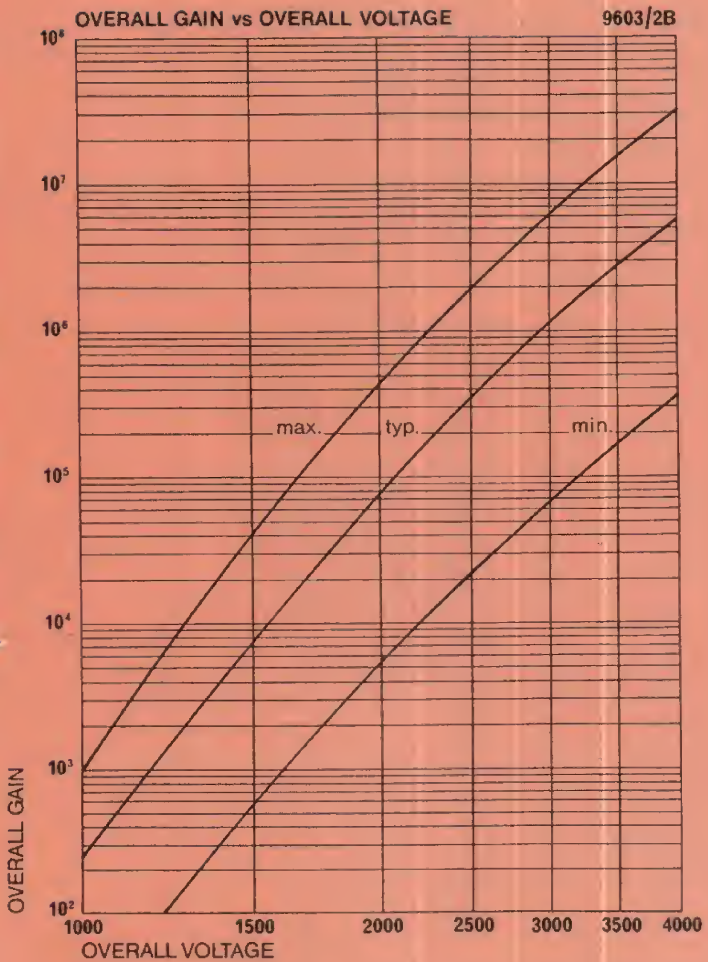

Side window (compact focused) tubes

The 9781B is an improved 9-stage, side window tube having a Corning 9741 glass envelope which transmits down to 2000Å. The spectral response of the caesium-antimony cathode is of the modified S-5 type with a peak between 3000Å and 4000Å. For those applications requiring an extension of the spectral response in the near UV to 1700Å, the 9783B, with a Spectrosil (fused silica) window, is available. Both types have a low dark current together with a high cathode sensitivity and gain with excellent long term and short term stability. They are therefore ideally suited for the detection of low level UV and visible radiation in spectrometry and similar applications.

Types 9661B and 9665B are basically similar to the 9781B and 9783B respectively and are useful in less demanding applications at lower cost.

The 9664B is also similar in design to the 9781B, but has an S-10 photocathode. It is useful where the prime requirement is good red sensitivity to approximately 8000Å, and is available with a quartz window as type 9670B.

All types are supplied overcapped with a B11A base but in many cases are also available uncapped (B14B socket) to special order. The relevant type numbers are as follows:

- Type 9661B available uncapped as type 9660B
- Type 9665B available uncapped as type 9662B
- Type 9664B available uncapped as type 9663B
- Type 9670B available uncapped as type 9669B



Notes

- 1 a) Each tube is individually calibrated and the test ticket furnished with the tube specifies the cathode sensitivity in $\mu\text{A}/\text{lm}$, the overall voltage at 50 A/lm (9781, 9783) or 20 A/lm (9661, 9665, 9664, 9670) and the dark current at that overall sensitivity.
- b) Test data is obtained with cathode -D1 voltage held at 100V and a linear dynode chain.*
- c) In general, when setting up experiments or designing for equipment, it is desirable to work at, or below, the ticket voltage of the individual tube.
- d) For highest stability in d.c. conditions, mean anode current should not exceed 10 μA . The 9781B and 9783B may become unstable if operated above 1000V due to the very high gain of these types.
- 2 Any material in contact with the glass envelope must be held at cathode potential. Failure to do so may result in erratic operation and high dark current.
- 3 Take great care in clamping tubes, particularly those with quartz envelopes. Excess pressure may fracture the glass in which case the warranty is void.

* For recommended dynode chains refer to Groups D, E, F, page 14.

ELECTRICAL RATINGS

Cathode to D1	150V Max.																
Recommended cathode to D1 voltage	100V																
Cathode to anode	1250V Max.																
Overall sensitivity: 9781B 9783B Rated 9661B 9665B 9664B 9670B Rated	50 A/lm 20 A/lm																
Max. anode current (mean)	0.5 mA																
Max. anode dissipation	0.5W																
Max. operating temperature	60°C																
Min. operating temperature	-180°C																
Anode pulse rise time	2ns																
Anode pulse f.w.h.m.	4ns																
Transit time	25ns																
Capacitance, anode to all dynodes	6pF																
Dark current shot noise Typical (λ peak)	<table border="0"> <tr> <td></td> <td>9781B</td> <td>9661B</td> <td>9664B</td> </tr> <tr> <td></td> <td>9783B</td> <td>9665B</td> <td>9670B</td> </tr> <tr> <td>lumens:</td> <td>3.7×10^{-13}</td> <td>9.5×10^{-13}</td> <td></td> </tr> <tr> <td>watts:</td> <td>3.7×10^{-16}</td> <td>7.1×10^{-16}</td> <td></td> </tr> </table>		9781B	9661B	9664B		9783B	9665B	9670B	lumens:	3.7×10^{-13}	9.5×10^{-13}		watts:	3.7×10^{-16}	7.1×10^{-16}	
	9781B	9661B	9664B														
	9783B	9665B	9670B														
lumens:	3.7×10^{-13}	9.5×10^{-13}															
watts:	3.7×10^{-16}	7.1×10^{-16}															

MECHANICAL CHARACTERISTICS

Max. envelope dia.	All 30.2mm (1.19 in)			
Min. cathode dia.	All 8×24mm (0.31×0.95 in)			
Cathode type	9781B 9661B 9664B	9783B 9665B 9670B	Modified S-5 S-10	S-5 S-5 S-10
Window material	9781B 9783B	9661B 9665B	9664B 9670B	Corning 9741 Quartz
Dynodes	Nine compact focused with CsSb secondary emitting surfaces			
Base	9781B 9783B 9661B 9665B 9664B 9670B—B11A socket (not furnished)			

Cathode Sensitivity $\mu\text{A}/\text{lm}$ Min. Typ.	Overall Sensitivity 20A/lm				Overall Sensitivity 50A/lm					
	V Overall		Dark Current nA		V Overall		Dark Current nA			
	Typ.	Max.	Typ.	Max.	Typ.	Max.	Typ.	Max.		
9781B 9783B	40	55	600	—	0.5	—	670	800	1.2	10
9661B 9665B	20	35	800	1000	2	20	900	—	5	—
9664B 9670B	20	35	750	1000	2	20	850	—	5	—

OVERALL SENSITIVITY vs OVERALL VOLTAGE

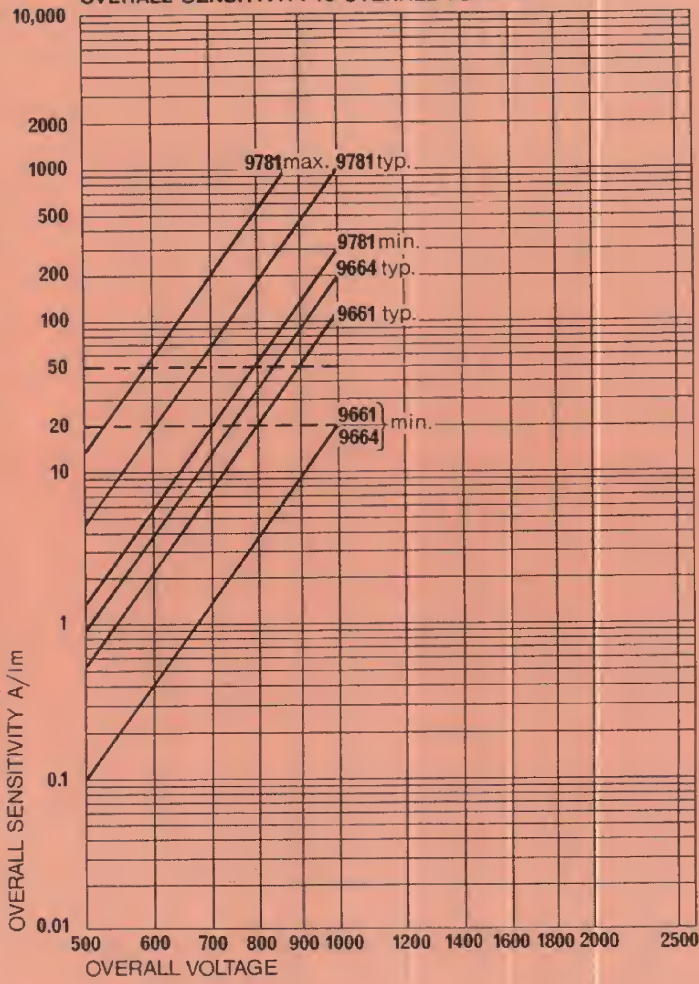

SPECTRAL RESPONSE

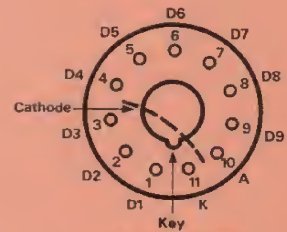
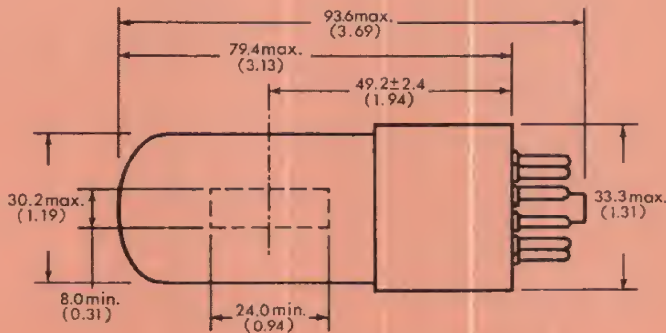
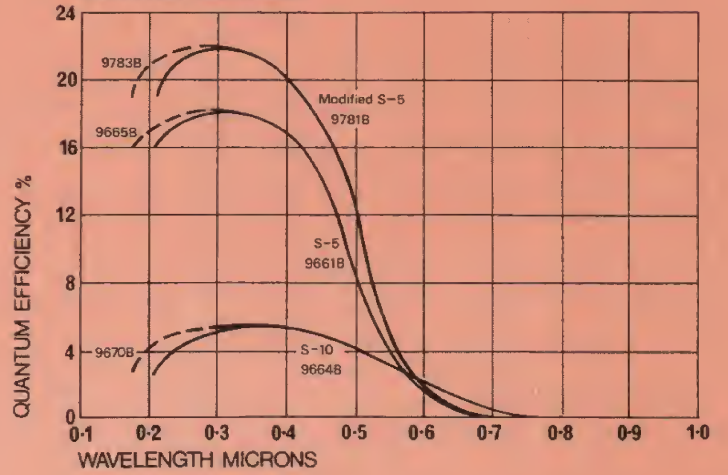

PIN CONNECTIONS
TYPES 9781, 9783, 9661, 9665, 9664, 9670
B11A SOCKET
(Viewed from below)

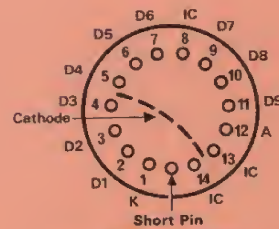
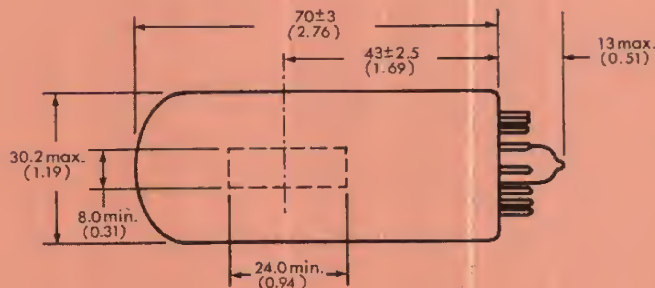

PIN CONNECTIONS
TYPES 9660, 9662, 9663, 9669
B14B SOCKET
(Viewed from below)

All dimensions are in millimetres with inches shown in parentheses.

30mm tubes S, S-11, S-13 cathodes

The 9524B is a small diameter (30 mm nom.) high gain photo-multiplier having 11 box and grid dynodes with highly stable CsSb surfaces. This type of dynode structure gives the highest gain per stage, for a given voltage, when compared with any of the other commonly used designs. The small size coupled with the high gain (typically 4×10^6 at 1000 volts), low dark current, and the inherently rugged design make the 9524B a very desirable tube for portable instruments and other applications where available power may be limited.

The 9524B has an S-11 (CsSbO) spectral response with a typical peak quantum efficiency in the region of $17\frac{1}{2}$ –20%. For very low light level applications, the 9524S should be used. This type incorporates the unique EMI "S" cathode which is specially processed for low thermionic emission. Typical dark current is of the order of 0.2 nanoamps.

Two other versions incorporate all the features of the 9524, but have Spectrosil (fused silica) windows (types 9526B and 9526S). This extends the spectral response in the near UV to ca. 1650Å. In addition to the photometric uses, the 9526 is very useful in low level scintillation counting, due to the low natural radioactivity in the window.

The 9601B is an S-11 type but equipped with a blown window of Corning 9741 glass, which extends the useful spectral range to ca. 1850Å and has the virtue of being considerably less expensive than the 9526B.

The 9734B is a 9-stage S-11 tube with a seated height of 87 mm compared with 112 mm for the 9524. It is therefore useful where size is an important factor and the high gain of the 9524 is not required. A Spectrosil (fused silica) version is also available, namely type 9734QB.

Notes

- Each tube is individually calibrated and the test ticket furnished with the tube specifies the cathode sensitivity in $\mu\text{A}/\text{lm}$, the overall voltage at 200 A/lm (9524, 9526, 9601) or 50 A/lm (9734) and the dark current at that overall sensitivity at 20°C.
 - Test data is obtained with cathode -D1 voltage held at 150V and a linear dynode chain.*
 - In general, when setting up experiments or designing for equipment, it is desirable to work at, or below, the ticket voltage of the individual tube.
 - For highest stability in d.c. conditions, mean anode current should not exceed 2 μA .
- Any material in contact with the glass envelope must be held at cathode potential. Failure to do so may result in erratic operation and high dark current.
- Take great care in clamping tubes, particularly those with Spectrosil (fused silica) windows. Excess pressure may fracture the glass in which case the warranty is void.
- Photomultipliers are affected by magnetic fields and mu-metal shields should be used, (see page 64).

* For recommended dynode chains refer to Groups H, I, J' (9524, 9526, 9601) and Groups E, F, F' (9734) on page 14.

MECHANICAL CHARACTERISTICS

Max. envelope dia.	29 mm (1.14 in)			
Nom. cathode dia.	23 mm (0.91 in)			
Cathode type	9524B	S-11	9524S	"S" (Q)
	9526B	S-13	9526S	"S" (C)
	9601B	S-11	9734QB	S-13
Window material	9524	9734B	Lime Soda	
	9526	9734QB	Spectrosil (fused silica)	
			9601B	Corning type 9741 (blown window, not optically flat)
Dynodes	9734 (9 stages); 9524, 9526, 9601 (11 stages): box and grid dynodes with CsSb secondary emitting surfaces			
Base	Low loss 14-pin pressed glass base furnished with high quality Teflon socket type B14B			



ELECTRICAL RATINGS

	9524 9526 9601	9734	
Cathode to D1	300V Max.	300V Max.	
Recommended cathode to D1 voltage	150V	150V	
Cathode to anode (subject to not exceeding)	2000V Max. 2000A/lm	1800V Max. 200A/lm	
Overall sensitivity: Rated Max.	200 A/lm 2000A/lm	50A/lm 200A/lm	
Max. anode current (mean)	100 μA	100 μA	
Max. anode dissipation	0.1W	0.1W	
Max. tolerable cathode current	0.1 μA	0.1 μA	
Max. operating temperature	60°C	60°C	
Min. operating temperature	-80°C	-80°C	
Anode pulse rise time	18 ns	17 ns	
Anode pulse f.w.h.m.	38 ns	30 ns	
Transit time	70 ns	65 ns	
Capacitance, anode to all dynodes	6 pF	6 pF	
Dark current shot noise Typical (λ peak)	9524B 9526B 9601B	9524S 9526S	9734B 9734QB
lumens:	1.5×10^{-13}	7.3×10^{-14}	2.1×10^{-13}
watts:	1.8×10^{-16}	0.9×10^{-16}	2.5×10^{-16}

Cathode Sensitivity $\mu\text{A}/\text{lm}$ Min. Typ.	Overall Sensitivity 200A/lm				Overall Sensitivity 2000A/lm					
	V Overall Typ.	V Overall Max.	Dark Current nA Typ.	Dark Current nA Max.	V Overall Typ.	V Overall Max.	Dark Current nA Typ.	Dark Current nA Max.		
9524B 9526B 9601B	50	70	950	1250	1	25	1300	—	10	—
9524S 9526S	40	60	950	1250	0.2	2	1300	—	2	—
	50A/lm				200A/lm					
9734B 9734QB	50	70	1000	1350	0.5	5	1300	—	2	—

9734B 9524B 9526B 9601B
 9734QB 9524S 9526S

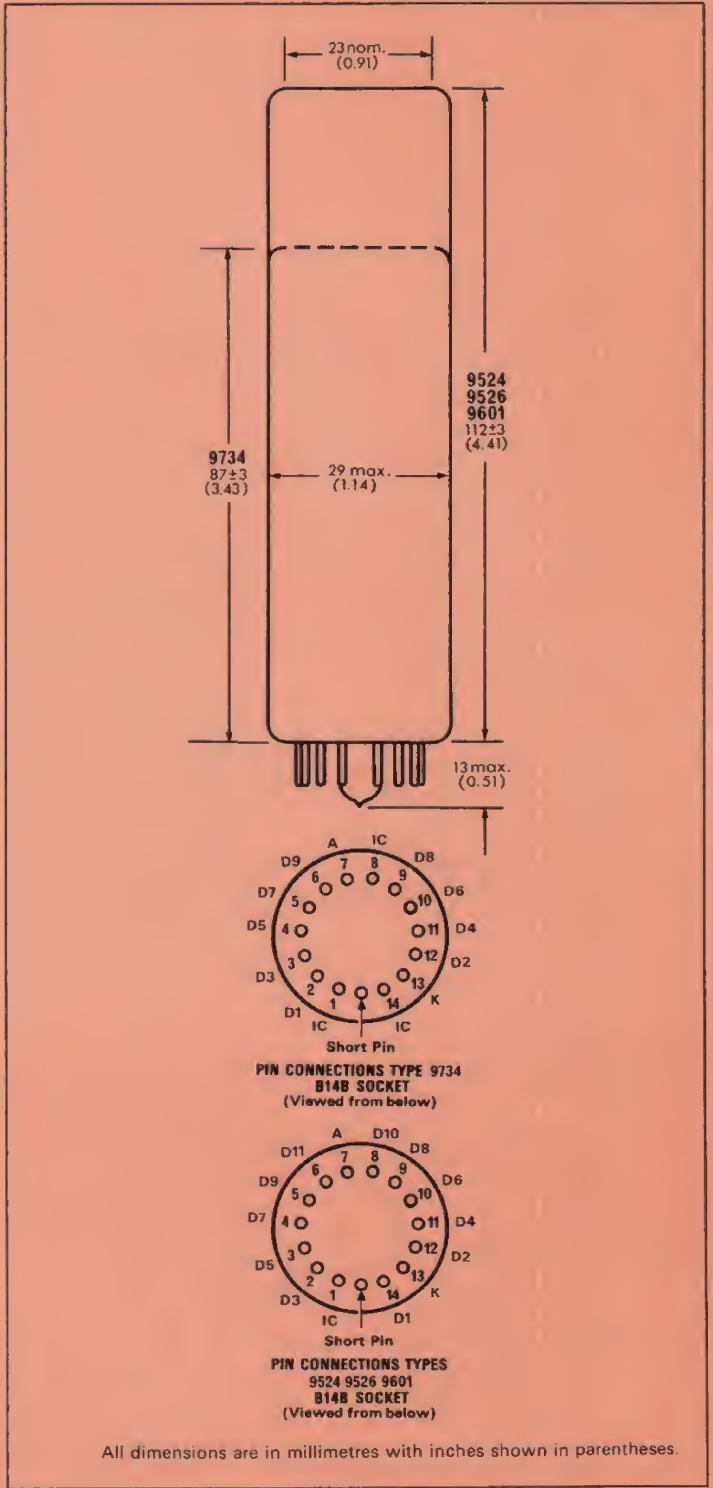
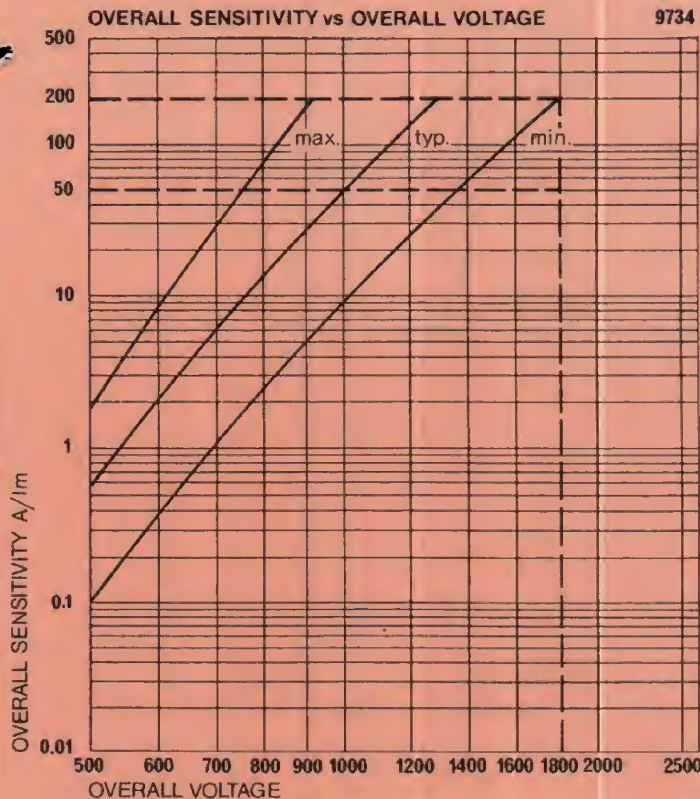
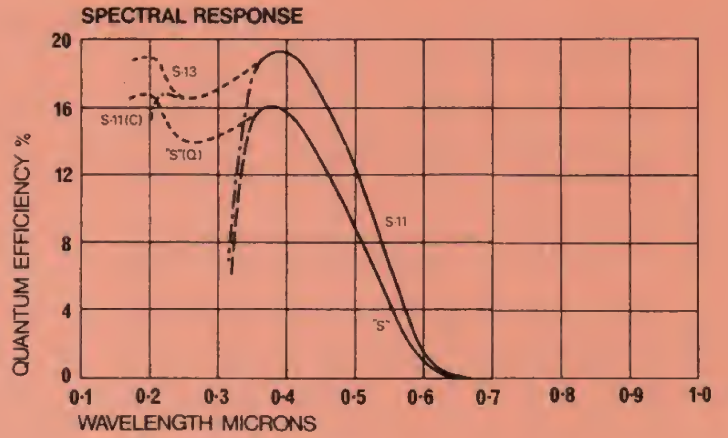
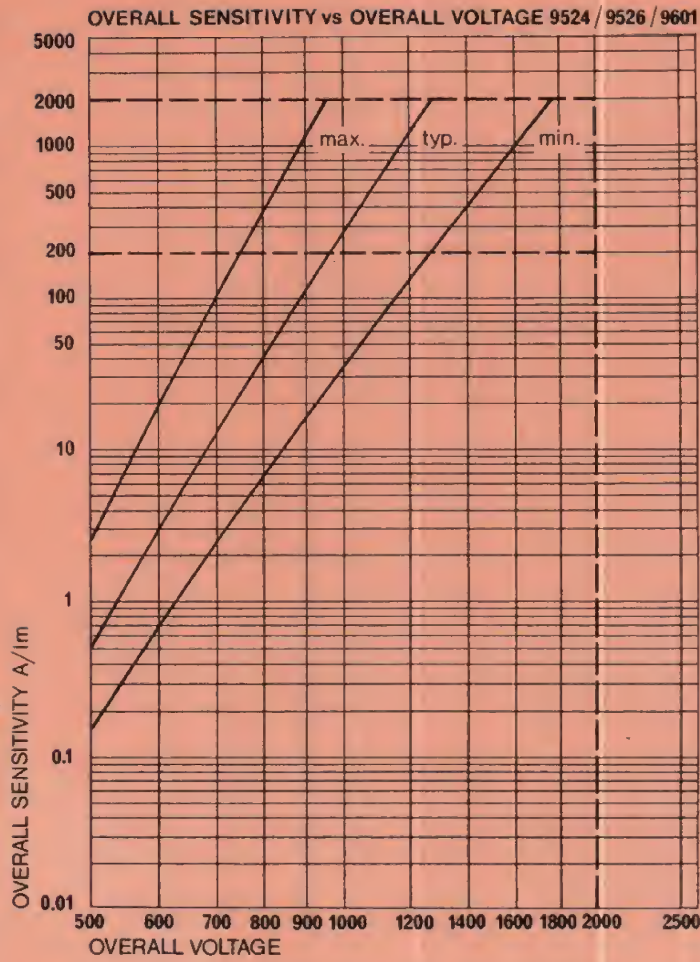

All dimensions are in millimetres with inches shown in parentheses.

30mm tubes S-10 cathodes

The EMI types 9529B and 9592B are 30 mm nominal diameter end-on photomultipliers having S-10 photocathodes. They utilise the sturdy EMI box and grid dynode system comprising 11 stages and having CsSb secondary emitting surfaces. This dynode system gives a very high gain per stage (for a given voltage) with excellent stability.

The 9592B is supplied with a blown window (not optically flat) of Corning 9741 glass which, combined with the S-10 cathode gives a spectral range of approximately 1850 to 7500Å. The 9529B differs only in that it is supplied with an optically flat Spectrosil (fused silica) window which gives a further extension in the UV to ca. 1650Å.

The wide spectral range of these types, coupled with high gain and reasonable dark current, make them eminently suitable for use in flame spectroscopy, wide range spectrophotometry and similar applications.



Notes

- 1 a) Each tube is individually calibrated and the test ticket furnished with the tube specifies the cathode sensitivity in $\mu\text{A}/\text{lm}$, the overall voltage at 200 A/lm and the dark current at that overall sensitivity at 20°C. When first plugged in, an excessive value of dark current may be observed. This falls to the equilibrium value after a period of storage in the dark. Due to the longer time taken for the dark current from cathodes of this variety to reach its limiting value, it may be found that values of equilibrium dark current actually obtained are lower than those indicated on the test ticket.
- b) Test data is obtained with cathode -D1 voltage held at 150V and a "Standard" dynode chain.*
- c) In general, when setting up experiments or designing for equipment, it is desirable to work at, or below, the ticket voltage of the individual tube.
- d) For highest stability in d.c. conditions, mean anode current should not exceed 2 μA .
- 2 Any material in contact with the glass envelope must be held at cathode potential. Failure to do so may result in erratic operation and high dark current.
- 3 Take great care in clamping tubes, particularly those with Spectrosil (fused silica) windows. Excess pressure may fracture the glass in which case the warranty is void.
- 4 Photomultipliers are affected by magnetic fields and mu-metal shields should be used, (see page 64).

* For recommended dynode chains refer to Groups H, I, J* on page 14.

MECHANICAL CHARACTERISTICS

Max. envelope dia.	29 mm (1.14 in)	
Nom. cathode dia.	23 mm (0.91 in)	
Cathode type	9592B S-10 (C)	9529B S-10 (Q)
Window material	9592B Corning type 9741	9529B Spectrosil (fused silica)
Dynodes	11 box and grid with CsSb secondary emitting surfaces	
Base	Low loss 14-pin pressed glass base furnished with high quality Teflon socket type B14B	

ELECTRICAL RATINGS

Cathode to D1	300V Max.
Recommended cathode to D1 voltage	150V
Cathode to anode (subject to not exceeding)	2000V Max. 2000A/lm
Overall sensitivity: Rated Max.	200 A/lm 2000 A/lm
Max. anode current (mean)	100 μA
Max. anode dissipation	0.1 W
Max. tolerable cathode current	0.5 μA
Max. operating temperature	60°C
Min. operating temperature	-80°C
Anode pulse rise time	12 ns
Anode pulse f.w.h.m.	50 ns
Transit time	70 ns
Capacitance, anode to all dynodes	6 pF
Dark current shot noise Typical (λ peak)	lumens: 5.6×10^{-13} watts: 1.2×10^{-15}

	Cathode Sensitivity $\mu\text{A}/\text{lm}$	Min.	Typ.	Overall Sensitivity 200A/lm		Overall Sensitivity 2000A/lm					
				V Overall Typ.	Dark Current nA Typ.	V Overall Typ.	Dark Current nA Typ.				
9592B	35		50	1100	1250	10	50	1500	—	100	—
9529B											

OVERALL SENSITIVITY vs OVERALL VOLTAGE

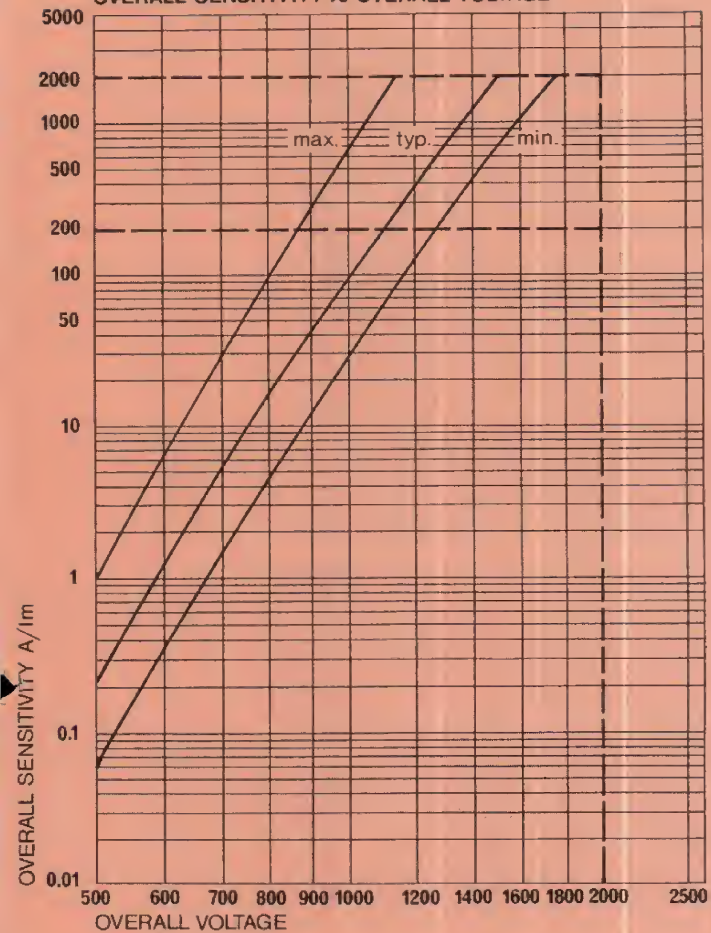

SPECTRAL RESPONSE

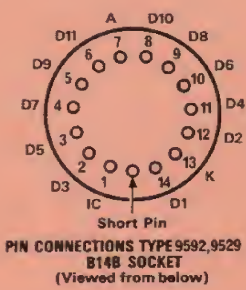
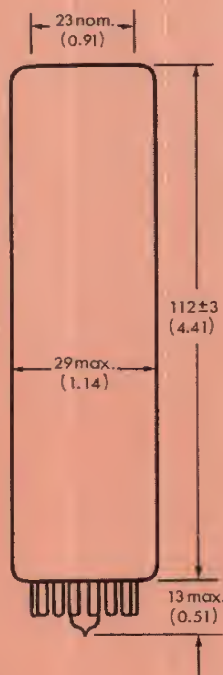
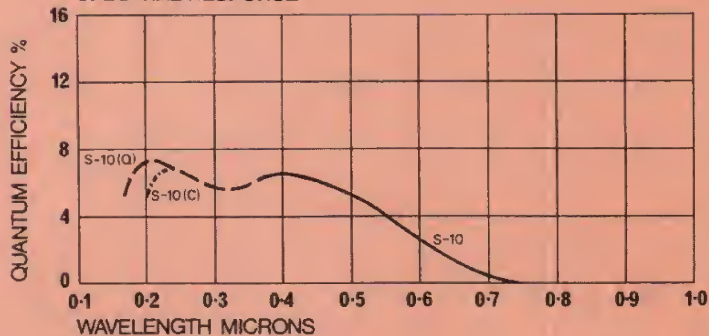

All dimensions are in millimetres with inches shown in parentheses.

30mm tubes S-20 cathodes

The EMI type 9698B is a 30mm nominal diameter flat faced, end-on photomultiplier. The photocathode is the S-20 (trialkali) type having a peak quantum efficiency of ca. 14% at 4000Å. At 6943Å the quantum efficiency is typically 2 to 3%.

The 9698B is supplied with a borosilicate window which, with the S-20 cathode, gives a spectral range of ca. 3000 to 8500Å. The 9698QB is supplied with a Spectrosil (fused silica) window which further extends the range in the UV down to 1650Å.

Both types have 9 box and grid dynodes with the highly efficient and stable CsSb secondary emitting surface developed by EMI.

The 9698 finds its principal uses where wide spectral response (or red sensitivity for use with lasers) small size and modest power requirements are of prime importance.

The 9698 can be cooled to -180°C , but thermionic emission is reduced to negligible proportions at -40°C . Care should be taken to cool slowly and uniformly in order to minimise thermal shock. The entire tube should be cooled, not just the cathode, and condensation of moisture at the base must be avoided (see R/PO21/CP5475 available on request).



Notes

- 1 a) Each tube is individually calibrated and the test ticket furnished with the tube specifies the cathode sensitivity in $\mu\text{A}/\text{lm}$, the overall voltage for 20 A/lm and the dark current at that overall sensitivity at 20°C . An indication of the spectral response of each tube is provided by measurements taken with three filters. A Corning glass filter (CS-5-58 ground to half stock thickness) is used to give a measure of the blue sensitivity. A Corning glass filter (CS-2-62), which passes all radiation longer than 0.6μ , gives some indication of the sensitivity to red light and a Wratten 87, which passes radiation longer than about 0.8μ , gives an indication of sensitivity in the near infra-red region. These filters are placed between the photocathode and a source giving 0.001 lumens at 2857°K .
- b) Tube data is measured with a "Standard" dynode chain and cathode -D1 voltage held at 150V.*
- c) In general, when setting up experiments or designing for equipment, it is desirable to work at, or below, the ticket voltage of the individual tube.
- d) For highest stability in d.c. conditions, mean anode current should not exceed $2\mu\text{A}$.
- 2 Any material in contact with the glass envelope must be held at cathode potential. Failure to do so may result in erratic operation and high dark current.
- 3 Take great care in clamping tubes, particularly those with Spectrosil (fused silica) windows. Excess pressure may fracture the glass in which case the warranty is void.
- 4 Photomultipliers are affected by magnetic fields and mu-metal shields should be used, (see page 64).
- 5 When cooling below -40°C the standard Teflon socket should not be used as it may deform and crack the glass. Instead, each pin should be connected separately and individual hyperboloidal contacts are available from EMI for this purpose.

* For recommended dynode chains refer to Groups D, E, F, F' on page 14.

MECHANICAL CHARACTERISTICS

Max. envelope dia.	29 mm (1.14 in)
Min. cathode dia.	23mm (0.91 in)
Cathode type	S-20 SbNaKCs
Window material	9698B Borosilicate 9698QB Spectrosil (fused silica)
Dynodes	9 box and grid with CsSb secondary emitting surfaces
Base	Low loss 14-pin pressed glass base furnished with high quality Teflon socket type B14B

ELECTRICAL RATINGS

Cathode to D1	300V Max.
Recommended cathode to D1 voltage	150V
Cathode to anode (subject to not exceeding)	1800V Max. 50A/lm
Overall sensitivity: Rated Max.	20A/lm 50A/lm
Max. anode current (mean)	100 μA
Max. anode dissipation	0.1W
Max. tolerable cathode current	1.0 μA
Max. operating temperature	60°C
Min. operating temperature	-180°C (-40°C useful lower limit)
Anode pulse rise time	18 ns
Anode pulse f.w.h.m.	30 ns
Transit time	75 ns
Capacitance, anode to all dynodes	6 pF
Dark current shot noise Typical (λ peak)	lumens: 1.7×10^{-13} watts: 2.8×10^{-16}

Cathode Sensitivity $\mu\text{A}/\text{lm}$ Min. Typ.	Overall Sensitivity 20A/lm				Overall Sensitivity 50A/lm					
	V Overall Typ.	V Max.	Dark Current nA Typ.	Dark Current nA Max.	V Overall Typ.	V Max.	Dark Current nA Typ.	Dark Current nA Max.		
9698B 9698QB	80	110	1300	1800	0.2	3	1550	—	0.5	—

OVERALL SENSITIVITY vs OVERALL VOLTAGE

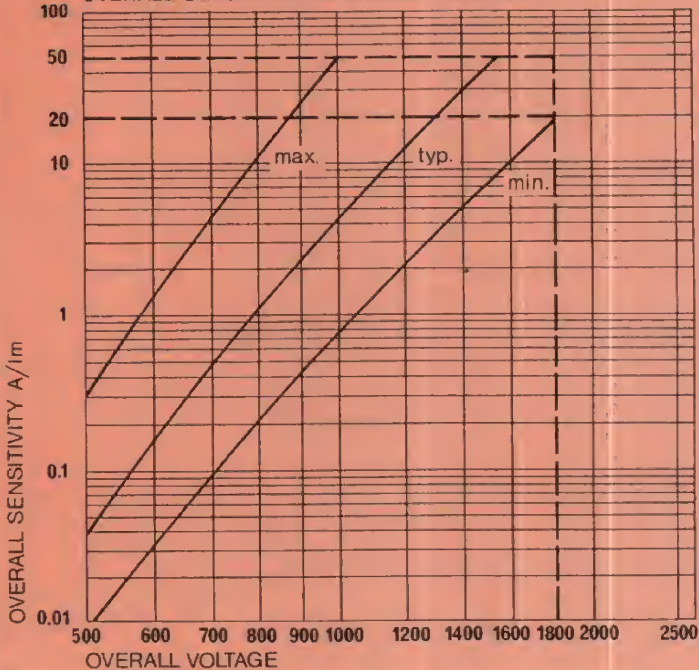

SPECTRAL RESPONSE

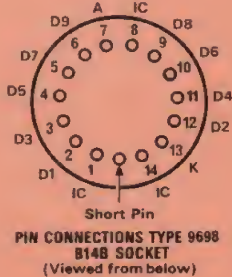
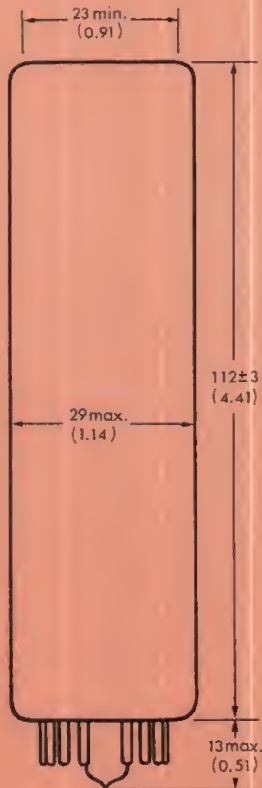
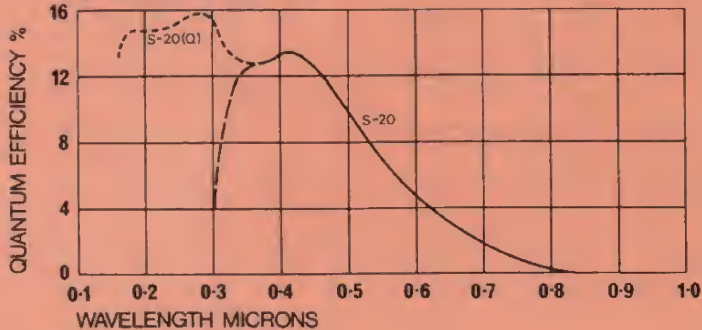

All dimensions are in millimetres with inches shown in parentheses.

50mm 6-stage tubes

The EMI type 9637 is a 50 mm (2 in.) nominal diameter end-on photomultiplier having a seated height of approximately 84 mm. The six venetian blind dynodes employ highly stable CsSb secondary emitting surfaces developed by EMI.

The 9637R is supplied with the "Super" S-11 cathode having a typical peak quantum efficiency of 23% at 4000Å. This type is very well suited for fast gamma ray spectrometers operating with minimum amplifier gain following the tube. The small number of stages reduces the rate of change of gain with voltage. When the application involves a fixed bandwidth and reasonable light levels so that gain is relatively unimportant, the 9637R is again a good choice.

The 9637B is a similar tube but has the standard S-11 cathode and is useful in less demanding applications at lower cost. It is available, to special order, overcapped with diheptal base as type 9637KB.



Notes

- Each tube is individually calibrated and the test ticket furnished with the tube specifies the cathode sensitivity in $\mu\text{A}/\text{lm}$, the overall voltage at 1 A/lm and the dark current at that overall sensitivity at 20°C.
 - Test data is obtained with cathode -D1 volts held at 150V, and a linear dynode chain.*
 - In general, when setting up experiments or designing for equipment, it is desirable to work at, or below, the ticket voltage of the individual tube.
 - For highest stability in d.c. conditions, mean anode current should not exceed 10 μA .
- Any material in contact with the glass envelope must be held at cathode potential. Failure to do so may result in erratic operation and high dark current.
- Take great care in clamping tubes. Excess pressure may fracture the glass in which case the warranty is void.
- Photomultipliers are affected by magnetic fields and mu-metal shields should be used, (see page 64).

* For recommended dynode chains refer to Groups A, B, C on page 14.

MECHANICAL CHARACTERISTICS

Max. envelope dia.	51.5 mm (2.02 in)
Nom. cathode dia.	44 mm (1.73 in)
Cathode type	9637R "Super" S-11 9637B S-11
Window material	Lime Soda
Dynodes	6 venetian blind with CsSb secondary emitting surfaces
Base	Low loss 15-pin pressed glass base furnished with high quality Teflon socket, type B15B. "K" is over-capped with diheptal base type B14A; socket not furnished

ELECTRICAL RATINGS

Cathode to D1	300V Max.									
Recommended cathode to D1 voltage	150V									
Cathode to anode (subject to not exceeding)	2000V Max. 5A/lm									
Overall sensitivity: Rated Max.	1A/lm 5A/lm									
Max. anode current (mean)	1 mA									
Max. anode dissipation	1W									
Max. tolerable cathode current	0.3 μA									
Max. operating temperature	60°C									
Min. operating temperature	-80°C									
Anode pulse rise time	10 ns									
Anode pulse f.w.h.m.	14 ns									
Transit time	40 ns									
Capacitance, anode to all dynodes	8 pF									
Dark current shot noise Typical (λ peak)	<table border="1"> <tr> <td></td> <td>9637B</td> <td>9637R</td> </tr> <tr> <td>lumens:</td> <td>6.8×10^{-13}</td> <td>5.6×10^{-13}</td> </tr> <tr> <td>watts:</td> <td>7.9×10^{-16}</td> <td>7.4×10^{-16}</td> </tr> </table>		9637B	9637R	lumens:	6.8×10^{-13}	5.6×10^{-13}	watts:	7.9×10^{-16}	7.4×10^{-16}
	9637B	9637R								
lumens:	6.8×10^{-13}	5.6×10^{-13}								
watts:	7.9×10^{-16}	7.4×10^{-16}								

	Cathode Sensitivity $\mu\text{A}/\text{lm}$	Overall Sensitivity 1A/lm				Overall Sensitivity 5A/lm				
		Min.	Typ.	V Overall Typ.	Dark Current nA Max.	V Overall Typ.	Dark Current nA Max.	V Overall Typ.	Dark Current nA Max.	
9637B	50	70	1200	1800	0.1	5	2000	—	0.5	—
9637R	80	100	1100	1300	0.1	1	1750	—	0.5	—

OVERALL SENSITIVITY vs OVERALL VOLTAGE

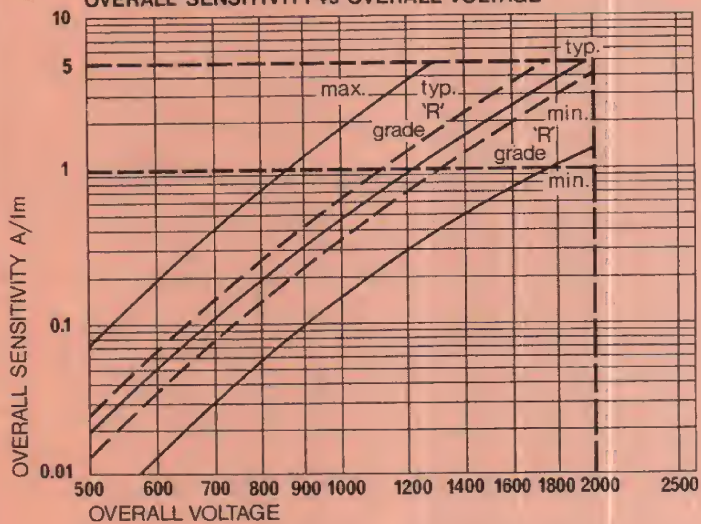

SPECTRAL RESPONSE

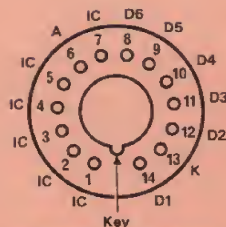
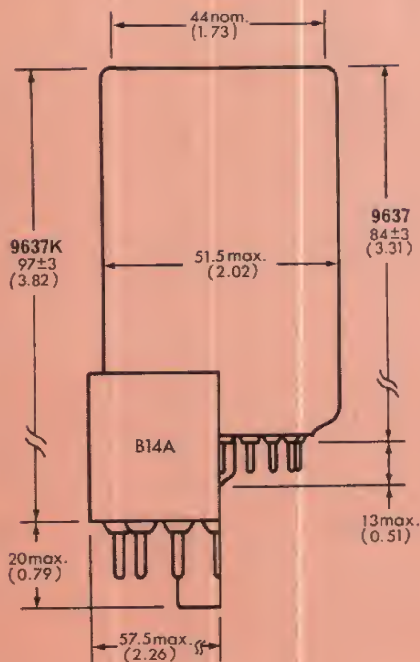
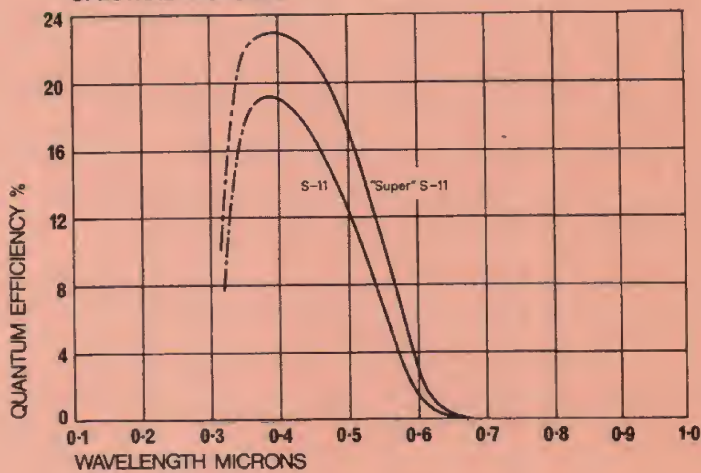

PIN CONNECTIONS TYPE 9637K B14A SOCKET (Viewed from below)

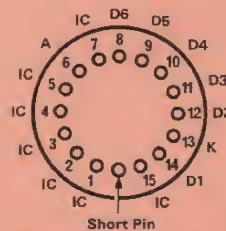

PIN CONNECTIONS TYPE 9637 B15B SOCKET (Viewed from below)

All dimensions are in millimetres with inches shown in parentheses.

50mm tubes, S, S-11, Super S-11, S-13 and Super S-13 cathodes

The 9656 series are 50mm (2 in.) nominal diameter end-on photomultipliers employing 10 venetian blind stages, coated with highly stable CsSb secondary emitting material as developed by EMI.

The 9656R incorporates the "Super" S-11 cathode with a typical peak quantum efficiency at 4000Å of 23%. In addition to the normal factory tests, each 9656R must meet an exacting resolution specification. Each tube must give a peak/valley ratio of 8:1 minimum for Co⁶⁰ with our standard factory NaI-Tl crystal. The combination of high quantum efficiency and very low dark current enables this type to give excellent separation of noise peak and photopeak resulting in extraordinary resolution for gamma rays and X-rays down to 2 keV.

Another variant, type 9656L, is available to special order only. This tube is to the same resolution specification as the 9656R but has a lower minimum photocathode sensitivity. Both "R" and "L" versions can be supplied overcapped with B14A base (e.g. 9656KR).

For film scanning and similar applications where the signal/noise depends primarily on high cathode sensitivity and where high gain is not critical, the 9656F is recommended at lower cost.

The 9656B and 9656S are made with standard S-11 and "S" cathodes respectively. The 9656B can be substituted for the 9656R in many less rigorous applications where cost may be a factor. The 9656S will, of course, find its major use in those applications where low dark current is the most significant parameter. The 9656B is available overcapped as type 9656KB and as such replaces type 9536B.

For those applications requiring an extension of the spectral range into the UV (ca. 1650Å), or where radioactivity in the window may be objectionable, the 9656QR is available to special order with a Spectrosil (fused silica) window. Similarly, for less rigorous applications, the 9656QB, with S-13 response, is available at lower cost, again to special order only.

The 9634QR is similar to the 9656QR, incorporating the "Super" S-11 cathode, but having 13 venetian blind dynodes. It is suitable for liquid scintillation counting as the low natural radioactivity in the Spectrosil (fused silica) window gives a significant reduction in background counts. For less stringent applications the 9634QB, with the standard S-11 cathode, is available at lower cost.



MECHANICAL CHARACTERISTICS

Max. envelope dia.	51.5 mm (2.02 in)		
Nom. cathode dia.	44 mm (1.73 in)		
Cathode type	9656R/F "Super" S-11	9656B/L S-11	9656S "S"
	9656QR "Super" S-13	9656QB S-13	(to special order only)
	9634QR "Super" S-13	9634QB S-13	
Window material	9656 Lime Soda Spectrosil to special order as type 9656Q 9634Q Spectrosil (fused silica)		
Dynodes	9656 (10 stages); 9634 (13 stages): venetian blind dynodes with CsSb secondary emitting surfaces		
Base	Low loss 19-pin pressed glass base furnished with high quality Teflon socket type B19A. Tubes with "K" suffix overcapped with diheptal base type B14A; socket not supplied		

ELECTRICAL RATINGS

	9656	9634
Cathode to D1	300V Max.	300V Max.
Recommended cathode to D1 voltage	150V	150V
Cathode to anode (subject to not exceeding)	2000V Max. 500A/lm	2500V Max. 5000A/lm
Overall sensitivity: Rated Max.	50A/lm 500A/lm	2000A/lm 5000A/lm
Max. anode current (mean)	1 mA	1 mA
Max. anode dissipation	1W	1W
Max. tolerable cathode current	0.3µA	0.3µA
Max. operating temperature	60°C	60°C
Min. operating temperature	-80°C	-80°C
Anode pulse rise time	6 ns	9 ns
Anode pulse f.w.h.m.	18 ns	15 ns
Transit time	48 ns	60 ns
Capacitance, anode to all dynodes	8 pF	8 pF
Dark current shot noise Typical (λ peak)	lumens: 2.5×10 ⁻¹³ watts: 3.3×10 ⁻¹⁶	9656R 4.3×10 ⁻¹³ 9656B 5.0×10 ⁻¹⁶
	lumens: 3.0×10 ⁻¹³ watts: 3.0×10 ⁻¹⁶	9634QR 2.2×10 ⁻¹³ 9634QB 3.4×10 ⁻¹³
		9656S 3.0×10 ⁻¹³ 9656R 2.8×10 ⁻¹⁶ 9634QB 4.0×10 ⁻¹⁶

Notes

- Each tube is individually calibrated and the test ticket furnished with the tube specifies the cathode sensitivity in µA/lm, the overall voltage at 50 A/lm (9656) or 2000 A/lm (9634) and the dark current at that overall sensitivity at 20°C.
 - Test data is obtained with cathode -D1 voltage held at 150V and a "Standard" dynode chain.*
 - In general, when setting up experiments or designing for equipment, it is desirable to work at, or below, the ticket voltage of the individual tube.
 - For highest stability in d.c. conditions, mean anode current should not exceed 10 µA.
- Any material in contact with the glass envelope must be held at cathode potential. Failure to do so may result in erratic operation and high dark current.
- Take great care in clamping tubes, particularly those with Spectrosil (fused silica) windows. Excess pressure may fracture the glass in which case the warranty is void.
- Photomultipliers are affected by magnetic fields and mu-metal shields should be used, (see page 64).

* For recommended dynode chains, refer to Groups D', E', F' (9656) or Groups K, L, M (9634) on page 14.

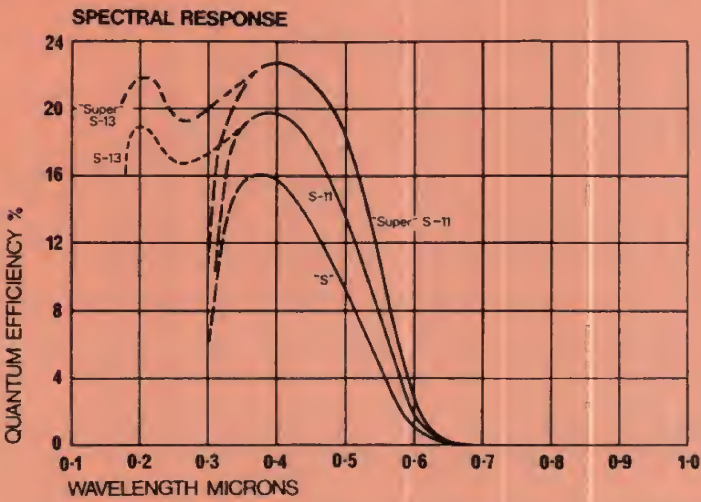
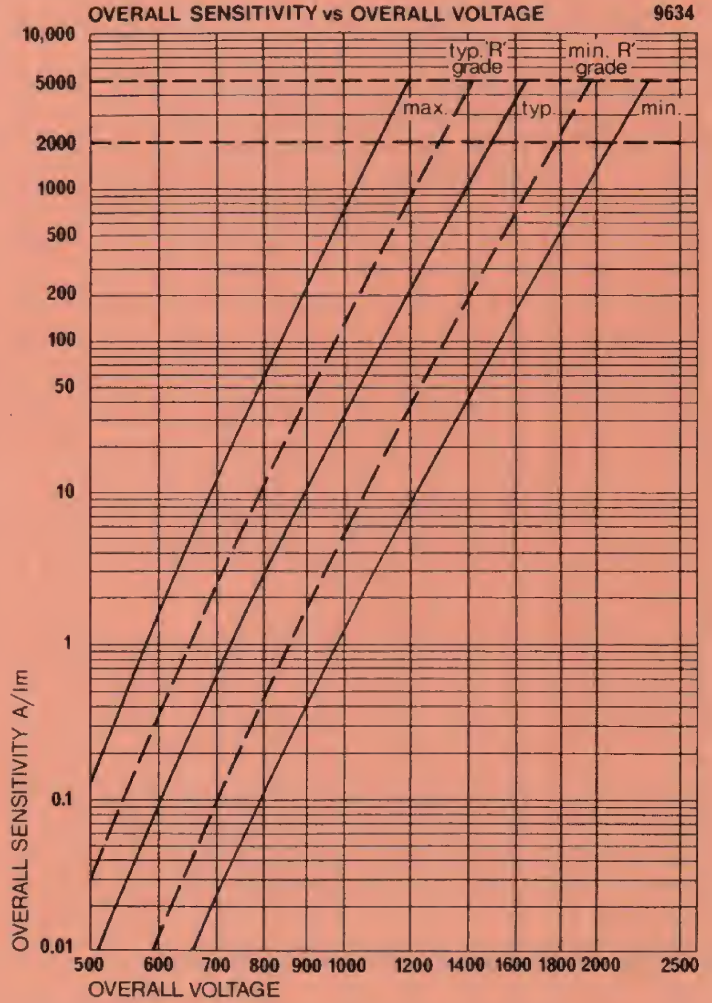
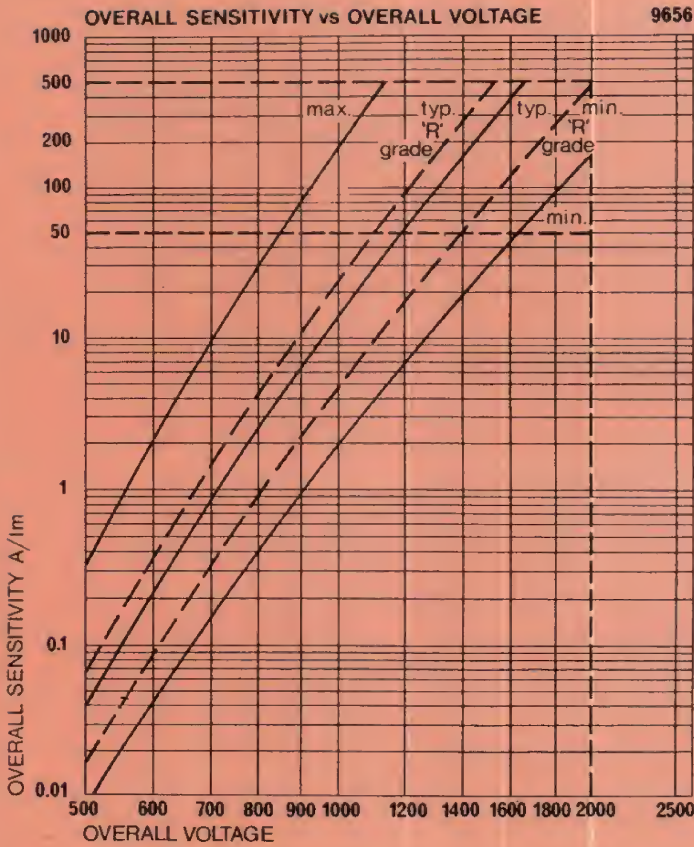

Type	Cathode Sensitivity $\mu\text{A/lm}$		Overall Sensitivity 50A/lm				Overall Sensitivity 500A/lm			
	Min.	Typ.	V Overall		Dark Current nA		V Overall		Dark Current nA	
			Typ.	Max.	Typ.	Max.	Typ.	Max.	Typ.	Max.
9656R	80	100	1100	1400	1	5	1550	—	10	—
9656F	80	90	1200	1650	2	15	1700	—	20	—
9656L	50	90	1100	1650	2	15	1550	—	20	—
9656B	50	70	1200	1650	2	15	1700	—	20	—
9656S	40	50	1200	1650	0.6	2	1700	—	6	—
			2000A/lm				5000A/lm			
9634QR	80	95	1300	1800	30	200	1450	—	75	—
9634QB	50	70	1500	2100	50	500	1700	—	125	—

The test ticket for type 9634 also shows a measurement of blue sensitivity referred to the same standard source with a Corning CS-5-58 filter (polished to half stock thickness) interposed.

Resolution: 9656R and 9656L must give a minimum peak/valley ratio for Co^{60} of 8:1 with standard factory crystal.

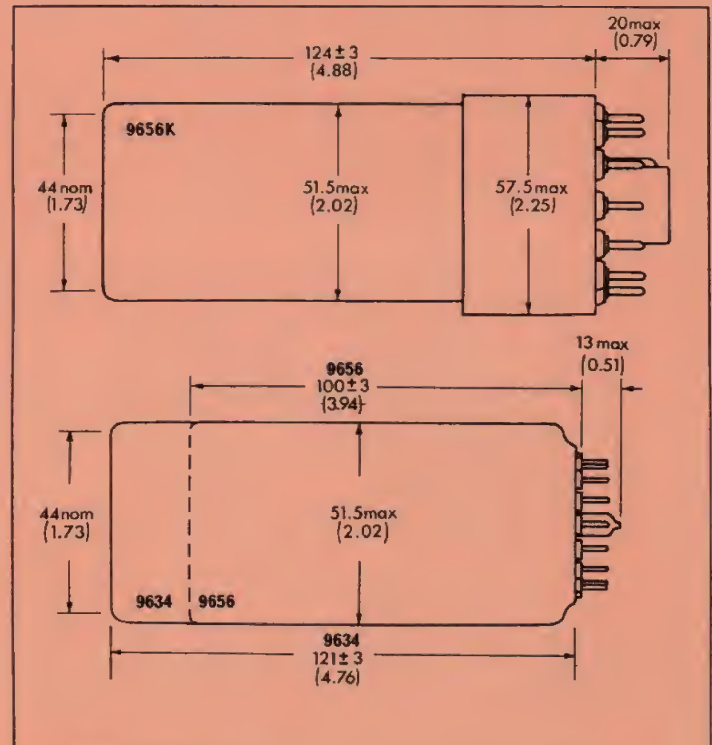

PIN CONNECTIONS (Viewed from below starting left of Short Pin/Key)

Type	1	2	3	4	5	6	7	8	9	10	11	12	13	14	15	16	17	18	19	Socket
9656	IC	D1	D2	D3	D4	D5	D6	D7	D8	D9	D10	A	IC	IC	IC	IC	IC	IC	K	B19A
9656K	D1	D2	D3	D4	D5	D6	D7	D8	D9	D10	A	IC	IC	K						B14A
9634	D1	D3	D5	D7	D9	D11	D13	A	D12	D10	D8	D6	D4	D2	IC	IC	IC	IC	K	B19A

All dimensions are in millimetres with inches shown in parentheses.

50mm tubes S, S-11, S-13 cathodes

The 6097 series are 50 mm (2 in.) nominal diameter end-on types providing a very useful combination of high gain, low dark current and good cathode sensitivity at relatively low cost. The highly stable dynode system utilises 11 venetian blind dynodes with CsSb secondary emitting surfaces.

The 6097B has an S-11 cathode and finds extensive use in flying spot scanning systems and similar applications where light levels are reasonable and dark current is not a limitation.

The 6097L is a variant of the 6097B and is useful in those scintillation counting applications where resolution is of prime importance. Each tube is tested with our standard factory NaI-Tl crystal (2 in. x 2 in.) and must give a peak to valley ratio for Co⁶⁰ of not less than 7:1. This corresponds roughly to a Cs¹³⁷ resolution of 7.8%.

The 6097S utilises the unique "S" cathode which is specially processed for low thermionic emission. It finds its main use in low level scintillation counting and in applications which are dark current limited.

The above types are available overcapped (e.g. 6097KB) to special order and a ruggedised variant is also available as type 9647NB (see page 59).

The 9514B has an S-11 photocathode and 13 venetian blind dynodes giving very high gains of the order of 10⁸. For low light level applications where the limitation is the tube dark current, the 9514S, which employs the unique EMI "S" cathode, is available.

For applications in the UV down to 1650Å, the 9514B and S are available with Spectrosil (fused silica) windows as types 6255B and 6255S respectively. They are also suitable for certain nucleonic applications due to the low natural radioactivity in the window.

The normal low dark currents of these tubes can be further reduced by cooling and a reduction of 10:1 is easily obtained by cooling to dry ice temperature. (See R/P021/CP5475 available on request.)

Note: The 6255B is being superseded by the 9634QB and new instruments or equipments should be designed with the 9634QB in mind. In addition, intending users of the 6097B should consider the 9656B as an alternative.

Notes

- 1 a) Each tube is individually calibrated and the test ticket furnished with the tube specifies the cathode sensitivity in $\mu\text{A}/\text{lm}$, the overall voltage at 200 A/lm (6097) or 2000 A/lm (6255, 9514) and the dark current at that overall sensitivity at 20°C.
- b) Test data is obtained with cathode -D1 volts held at 150V and a "Standard" dynode chain.*
- c) In general, when setting up experiments or designing for equipment, it is desirable to work at, or below, the ticket voltage of the individual tube.
- d) For highest stability in d.c. conditions, mean anode current should not exceed 10 μA .
- 2 Any material in contact with the glass envelope must be held at cathode potential. Failure to do so may result in erratic operation and high dark current.
- 3 Take great care in clamping tubes, particularly those with Spectrosil (fused silica) windows. Excess pressure may fracture the glass in which case the warranty is void.
- 4 Photomultipliers are affected by magnetic fields and mu-metal shields should be used, (see page 64).
- 5 When cooling below -40°C the standard Teflon socket should not be used as it may deform and crack the glass. Instead, each pin should be connected separately and individual hyperboloidal contacts are available from EMI for this purpose.

* For recommended dynode chains refer to Groups H, I, J (6097) or Groups K, L, M (6255, 9514) on page 14.



MECHANICAL CHARACTERISTICS

Max. envelope dia.	51.5 mm (2.02 in)	
Nom. cathode dia.	44 mm (1.73 in)	
Cathode type	6097B 9514B 6255B	6097L S-11 9514S "S" 6255S "S" (Q)
Window material	6097	9514 Lime Soda or Borosilicate 6255 Spectrosil (fused silica)
Dynodes	6097 (11 stages); 9514, 6255 (13 stages): venetian blind dynodes with CsSb secondary emitting surfaces	
Base	Low loss 15-pin pressed glass base furnished with high quality Teflon socket type B15B	

ELECTRICAL RATINGS

	6097	6255 9514	
Cathode to D1	300V Max.	300V Max.	
Recommended cathode to D1 voltage	150V	150V	
Cathode to anode (subject to not exceeding)	2200V Max. 2000A/lm	2500V Max. 5000A/lm	
Overall sensitivity: Rated Max.	200A/lm 2000A/lm	2000A/lm 5000A/lm	
Max. anode current (mean)	1 mA	1 mA	
Max. anode dissipation	1 W	1 W	
Max. tolerable cathode current	0.3 μA	0.3 μA	
Max. operating temperature	60°C	60°C	
Min. operating temperature	-80°C	-80°C	
Anode pulse rise time	10 ns	9 ns	
Anode pulse f.w.h.m.	14 ns	15 ns	
Transit time	55 ns	60 ns	
Capacitance, anode to all dynodes	8 pF	8 pF	
Dark current shot noise Typical (λ peak)	6097B 6255B 9514B	6097S 6255S 9514S	6097L
lumens:	3.4×10^{-13}	1.6×10^{-13}	2.9×10^{-13}
watts:	4.0×10^{-16}	2.0×10^{-16}	4.6×10^{-16}

Cathode Sensitivity $\mu\text{A}/\text{lm}$ Min. Typ.		Overall Sensitivity 200A/lm				Overall Sensitivity 2000A/lm				
		V Overall		Dark Current nA		V Overall		Dark Current nA		
		Typ.	Max.	Typ.	Max.	Typ.	Max.	Typ.	Max.	
6097B	50	70	1250	1800	5	50	1750	—	50	—
6097L	50	95	1200	1800	5	50	1700	—	50	—
6097S	40	60	1300	1800	1	4	1800	—	10	—
6255B 9514B	50	70	2000A/lm				5000A/lm			
			1500	2100	50	500	1650	—	125	—
6255S 9514S	40	60	1600	2100	10	40	1800	—	25	—

Resolution: 6097L must give a minimum peak/valley ratio for Co^{60} of 7:1 with standard factory crystal.

9514B 6255B 6097B 6097L
9514S 6255S 6097S

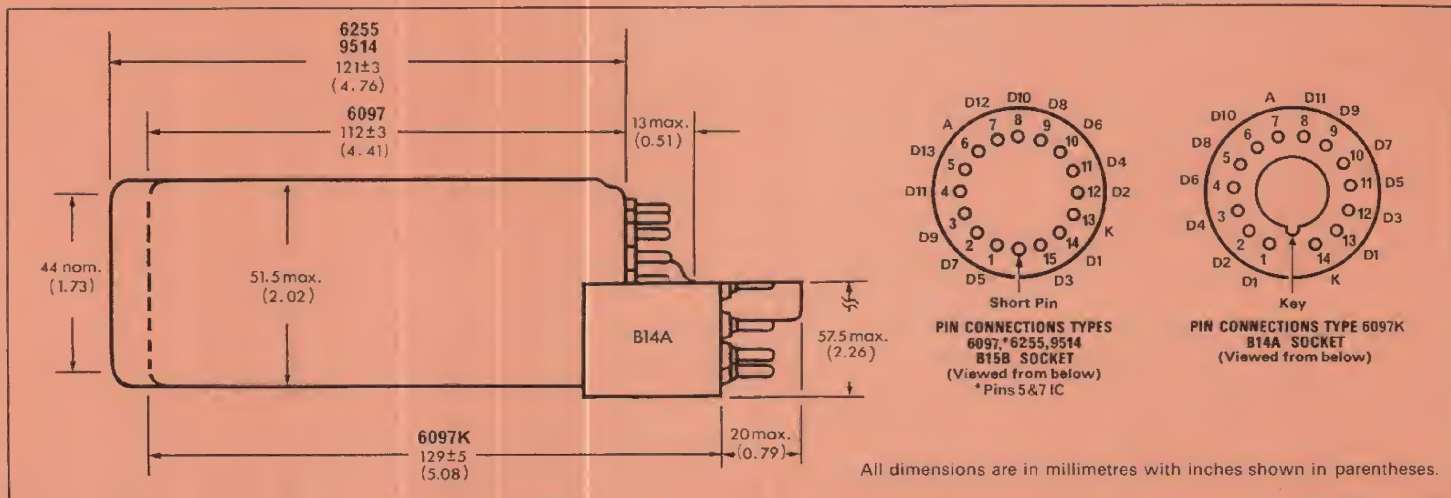
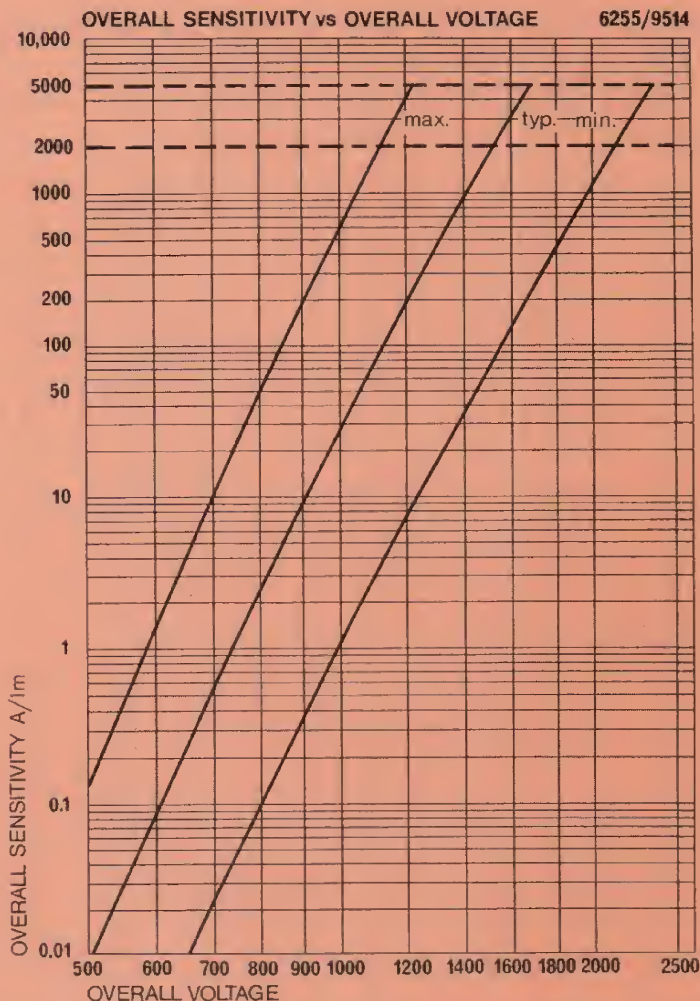
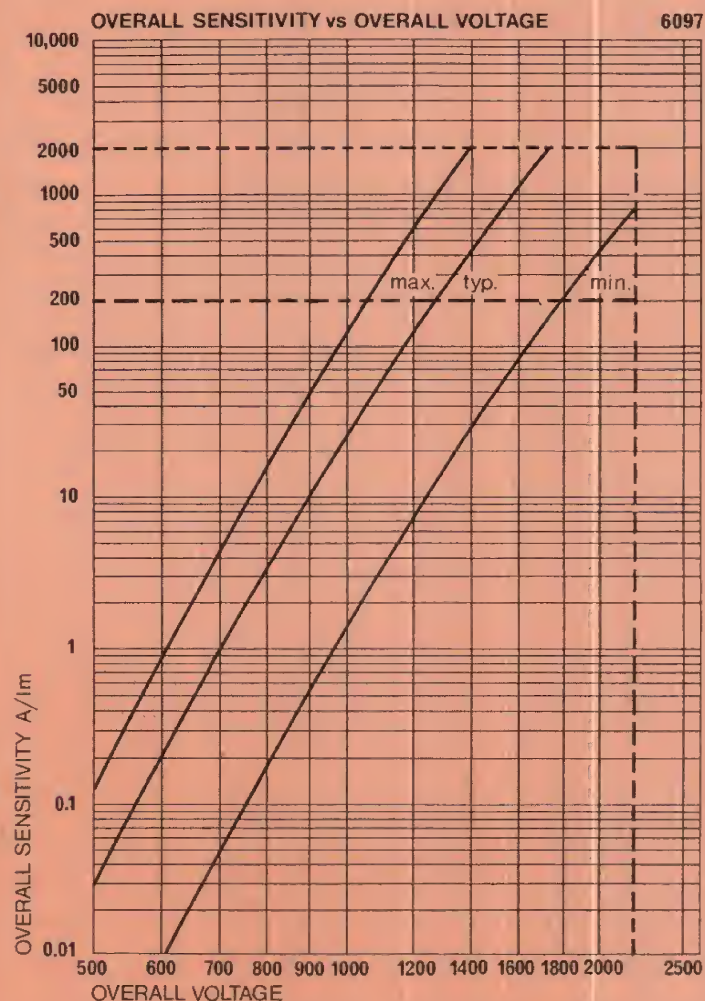
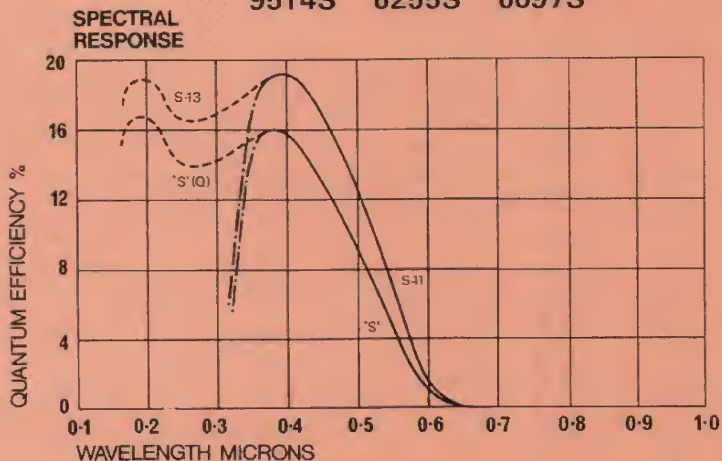

All dimensions are in millimetres with inches shown in parentheses.

50mm tubes S-1 cathodes

The EMI photomultiplier tube 9684B is a 50 mm (2 in.) nominal diameter flat-faced end window tube with a 44 mm semitransparent cathode. The dynodes are of the box and grid type coated with BeCu secondary emitting material. Since the dynodes are the standard 30mm type, a focusing electrode is incorporated to ensure optimum collection efficiency. The tube is of a robust construction.

The cathode is of the S-1 (AgOCs) type having a spectral range from 0.3 to approximately 1.2 microns. Although the quantum efficiency of the S-1 photocathode is fairly low (0.4% at 0.8 microns) it is the only existing photocathode which provides any response in the region between 0.9 and 1.2 microns and is therefore very useful for certain laser and astronomical applications.

The S-1 surface has quite a high dark current compared to other photocathodes, but the dark current falls rapidly with temperature. Cooling to dry ice temperature results in a reduction in dark current of several orders of magnitude. Cooling should be done slowly and uniformly in order to avoid damage to the tube.

The S-1 surface is also available, to special order, in a 75 mm (3 in.) configuration. The type number is 9710B (see page 44).

Notes

- 1 a) Each tube is individually calibrated and the test ticket furnished with the tube specifies the cathode sensitivity in $\mu\text{A}/\text{lm}$, the overall voltage for 20 A/lm and the dark current at that overall sensitivity at 20 °C. An indication of the spectral response of each tube is provided by measurements taken with four filters. A Corning glass filter (CS-5-58 ground to half stock thickness) is used to give a measure of the blue sensitivity. A Corning glass filter (CS-2-62) which passes all radiation longer than 0.6 μ gives some indication of the sensitivity to red light and a Wratten 87 which passes radiation longer than about 0.8 μ gives an indication of sensitivity in the near infra-red region. These filters are placed between the photocathode and a source giving 0.001 lumens at 2857 °K. A narrow band relative measurement is also made at 1 μ .
- b) Tube data is measured with a "Standard" dynode chain and cathode -D1 voltage held at 150V.*
- c) In general, when setting up experiments or designing for equipment, it is desirable to work at, or below, the ticket voltage of the individual tube.
- d) For highest stability in d.c. conditions, mean anode current should not exceed 2 μA .
- 2 Any material in contact with the glass envelope must be held at cathode potential. Failure to do so may result in erratic operation and high dark current.
- 3 Take great care in clamping tubes, particularly those with Spectrosil (fused silica) windows. Excess pressure may fracture the glass in which case the warranty is void.
- 4 Photomultipliers are affected by magnetic fields and mu-metal shields should be used, (see page 64).
- 5 When cooling below -40 °C the standard Teflon socket should not be used as it may deform and crack the glass. Instead, each pin should be connected separately and individual hyperboloidal contacts are available from EMI for this purpose.

* For recommended dynode chains, refer to Groups H, I, J on page 14. Focus: with 150 volts cathode -D1, a setting of -50 volts with respect to D1 is satisfactory for most applications.

MECHANICAL CHARACTERISTICS

Max. envelope dia.	51.5 mm (2.02 in)
Min. cathode dia.	44 mm (1.73 in)
Cathode type	S-1
Window material	Borosilicate Spectrosil to special order (9684QB)
Dynodes	11 box and grid with BeCu secondary emitting surfaces and focus
Base	Low loss 19-pin pressed glass base furnished with high quality Teflon socket type B19A



ELECTRICAL RATINGS

Cathode to D1	300V Max.
Recommended cathode to D1 voltage	150V
Cathode to anode (subject to not exceeding)	3000V 50A/lm
Overall sensitivity: Rated Max.	20A/lm 50A/lm
Max. anode current (mean)	0.5mA
Max. anode dissipation	0.5W
Max. operating temperature	60 °C
Min. operating temperature	-180 °C
Anode pulse rise time	7ns
Anode pulse f.w.h.m.	15ns
Transit time	60ns
Capacitance, anode to all dynodes	6 pF
Dark current shot noise Typical (λ peak)	lumens: 5.6×10^{-11} watts: 5.5×10^{-13}

	Cathode Sensitivity $\mu\text{A}/\text{lm}$		Overall Sensitivity 20A/lm		Overall Sensitivity 50A/lm					
	Min.	Typ.	V Overall Typ.	Dark Current μA Typ. Max.	V Overall Typ.	Dark Current μA Typ. Max.				
9684B	15	25	1400	2100	5	20	1650	—	13	—

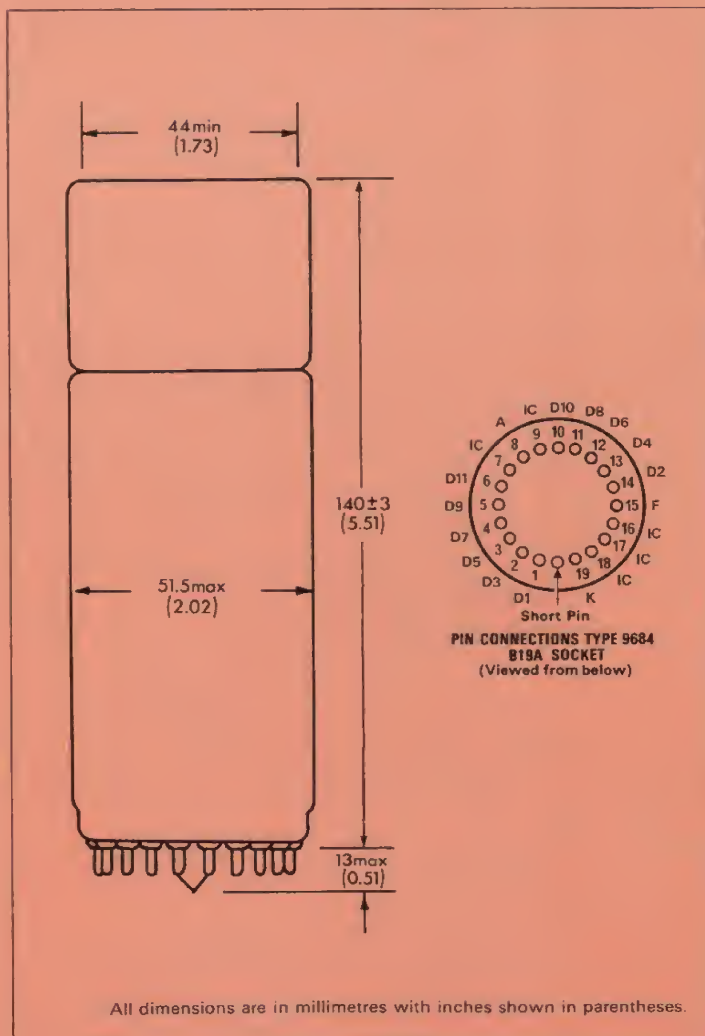
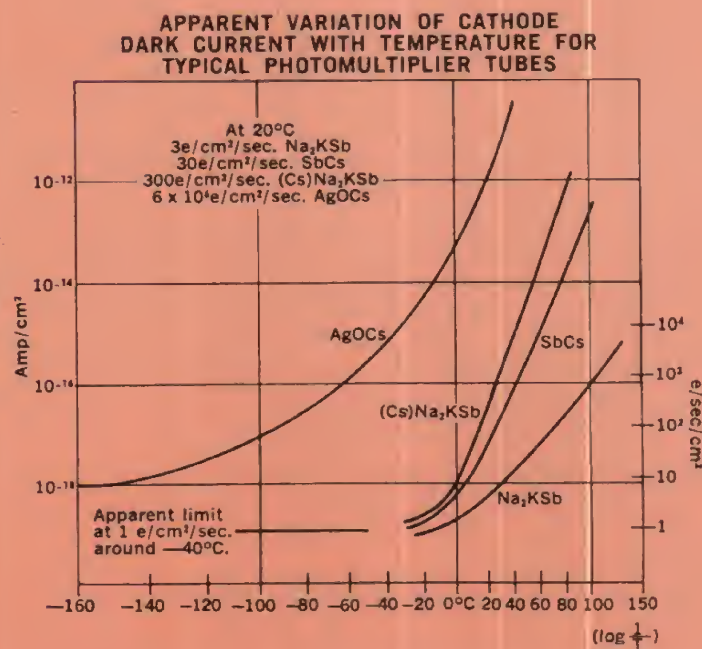
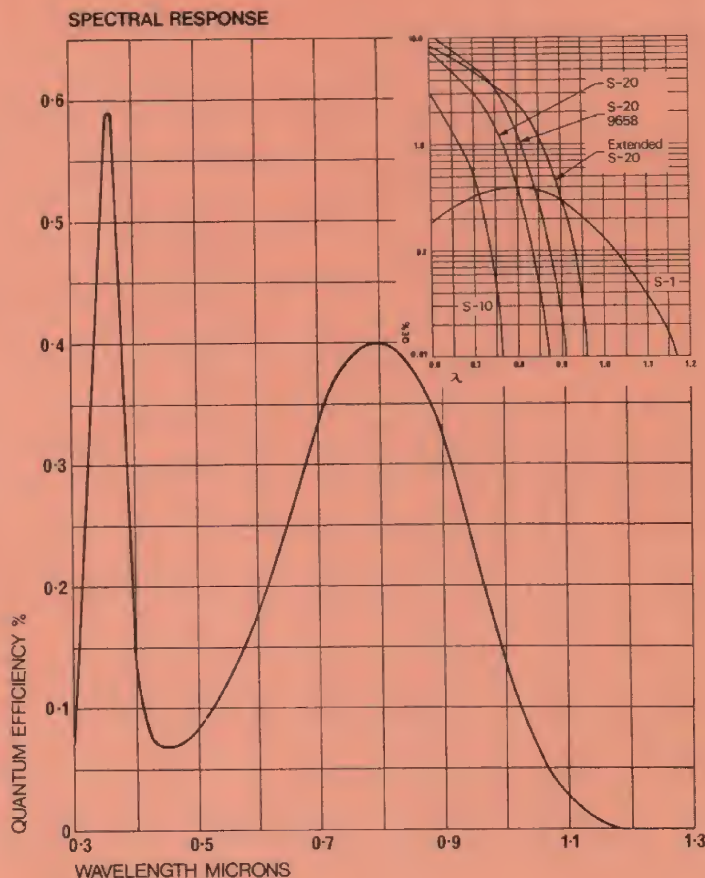
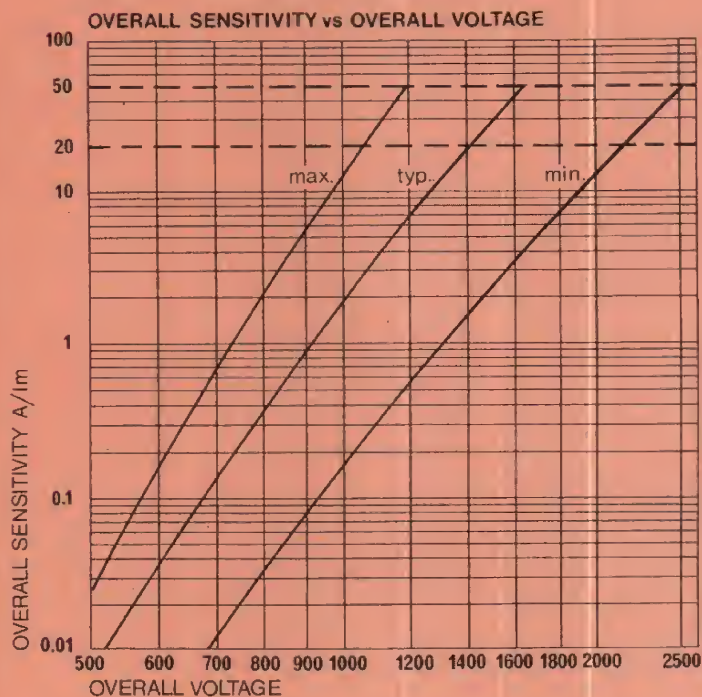

50mm tubes S-20 and Extended S-20 cathodes

The EMI photomultiplier type 9558B is a 50 mm (2 in.) nominal diameter tube with a 44mm cathode and 11 venetian blind dynodes having highly stable CsSb secondary emitting surfaces. The cathode is of the S-20 (trialkali) type which provides very high quantum efficiency in the blue as well as extremely good response in the red extending out to approximately 8500Å. When provided with a Spectrosil (fused silica) window, the tube is known as type 9558QB and the spectral range is then 1650 to 8500Å.

The high red response, coupled with very low dark current and a gain of 2×10^6 make the 9558B extremely useful with ruby lasers and in certain astronomical applications. The 9558QB, with its extremely wide spectral coverage, is used in many commercially available spectrophotometers and in a large range of research applications throughout the world.

New developments at EMI have led to the production of a new version of the 9558 with an "Extended" S-20 cathode, namely type 9659B. This provides an extremely high infra-red response extending to beyond 9000Å, together with the low dark current and high gain inherent in EMI photomultiplier tubes. The infra-red sensitivity is measured with a Wratten 87 filter and is typically 25 units (see Note 1 (a)). This corresponds to approximately 2.5% quantum efficiency at 8000Å. The 9659B is also available with a Spectrosil window as type 9659QB.

Types 9658R and 9658B are again basically similar to the 9558, but incorporate an internally corrugated end window which causes multiple reflections of the incident light and enhances the red sensitivity. Although the quantum efficiency of these types does not extend as far into the infra-red as the "Extended" S-20 cathode, it does provide an extremely high response in the visible spectrum.

The above types may be cooled to -180°C , but thermionic emission is reduced to negligible proportions at -40°C . Another useful technique for reducing dark current and improving signal to background ratio is to place a small pancake solenoid over the end of the tube near the first dynode. These techniques are both described in EMI document R/P021/CP5475.

All tubes can be supplied with a spectral calibration giving the quantum efficiency at various wavelengths. In this case, "M" is added to the suffix (e.g. 9558QBM).

Notes

- 1 a) Each tube is individually calibrated and the test ticket furnished with the tube specifies the cathode sensitivity in $\mu\text{A}/\text{lm}$, the overall voltage for 200 A/lm and the dark current at the overall sensitivity at 20°C . An indication of the spectral response of each tube is provided by measurements taken with three filters. A Corning glass filter (CS-5-5B ground to half stock thickness) is used to give a measure of the blue sensitivity. A Corning glass filter (CS-2-62), which passes all radiation longer than 0.6μ , gives some indication of the sensitivity to red light and a Wratten 87, which passes radiation longer than about 0.8μ , gives an indication of sensitivity in the near infra-red region. These filters are placed between the photocathode and a source giving 0.001 lumens at 2857°K .
 - b) Tube data is measured with a "Standard" dynode chain and cathode -D1 voltage held at 150V.*
 - c) In general, when setting up experiments or designing for equipment, it is desirable to work at, or below, the ticket voltage of the individual tube.
 - d) For highest stability in d.c. conditions, mean anode current should not exceed $10\mu\text{A}$.
 - 2 Any material in contact with the glass envelope must be held at cathode potential. Failure to do so may result in erratic operation and high dark current.
 - 3 Take great care in clamping tubes, particularly those with Spectrosil (fused silica) windows. Excess pressure may fracture the glass in which case the warranty is void.
 - 4 Photomultipliers are affected by magnetic fields and mu-metal shields should be used, (see page 64).
 - 5 When cooling below -40°C the standard Teflon socket should not be used as it may deform and crack the glass. Instead, each pin should be connected separately and individual hyperboloidal contacts are available from EMI for this purpose.
- * For recommended dynode chains, refer to Groups H, I, J on page 14.

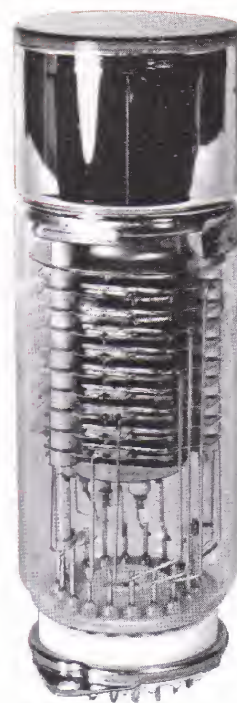

MECHANICAL CHARACTERISTICS

Max. envelope dia.	51.5 mm (2.02 in)		
Min. cathode dia. (9558, 9659)	44 mm (1.73 in)		
Min. useful cathode dia. (9658)	30 mm (1.18 in)		
Cathode type	9558	9658	S-20 9659 Extended S-20
Window material	9558B 9558QB	9659B 9659QB	9658 Borosilicate Spectrosil (fused silica)
Dynodes	11 venetian blind with CsSb secondary emitting surfaces		
Base	Low loss 19-pin pressed glass base furnished with high quality Teflon socket type B19A		

ELECTRICAL RATINGS

Cathode to D1	300V Max.		
Recommended cathode to D1 voltage	150V		
Cathode to anode (subject to not exceeding)	2200V Max. 2000A/lm		
Overall sensitivity: Rated Max.	200A/lm 2000A/lm		
Max. anode current (mean)	1 mA		
Max. anode dissipation	1 W		
Max. tolerable cathode current	$5\mu\text{A}$		
Max. operating temperature	60°C		
Min. operating temperature	-180°C (-40°C useful lower limit)		
Anode pulse rise time	10 ns		
Anode pulse f.w.h.m.	15 ns		
Transit time	55 ns		
Capacitance, anode to all dynodes	8 pF		
Dark current shot noise Typical (λ peak)		9558B 9558QB	9658B 9659B 9659QB
	lumens:	1.4×10^{-13}	1.2×10^{-13}
	watts:	3.5×10^{-16}	3.9×10^{-16}
		9658R	9659QB
	lumens:	1.0×10^{-13}	1.2×10^{-13}
	watts:	4.6×10^{-16}	4.1×10^{-16}

	Infra-red Sensitivity with Wratten 87 filter		Cathode Sensitivity $\mu\text{A}/\text{lm}$	
	Min.	Typ.	Min.	Typ.
9558B 9558QB	0.6	4	120	170
9658B	0.6	6	180	220
9658R	0.6	10	250	300
9659B 9659QB	15	25	—	220

	Overall Sensitivity 200A/lm				Overall Sensitivity 2000A/lm			
	V Overall		Dark Current nA		V Overall		Dark Current nA	
	Typ.	Max.	Typ.	Max.	Typ.	Max.	Typ.	Max.
9558B 9558QB	1100	2000	2	10	1450	—	20	—
9658B	1100	2000	2	10	1450	—	20	—
9658R	1100	2000	2	10	1450	—	20	—
9659B 9659QB	1100	2000	2	10	1450	—	20	—

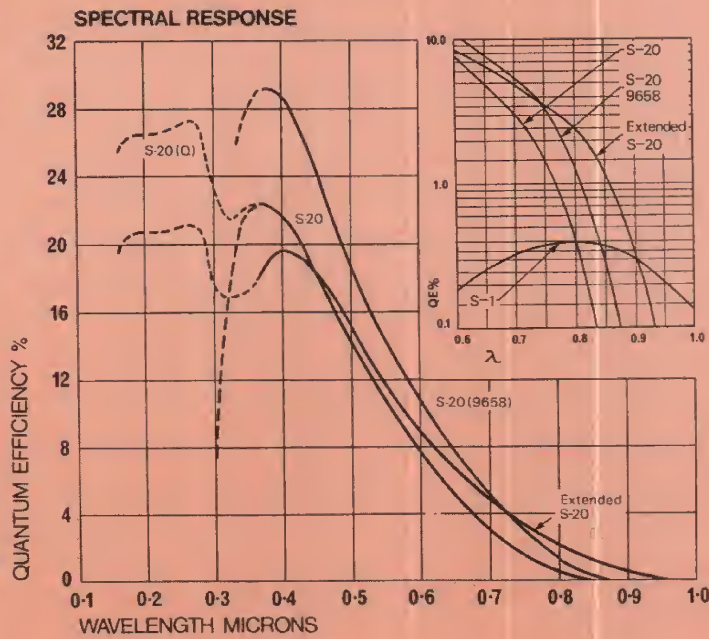
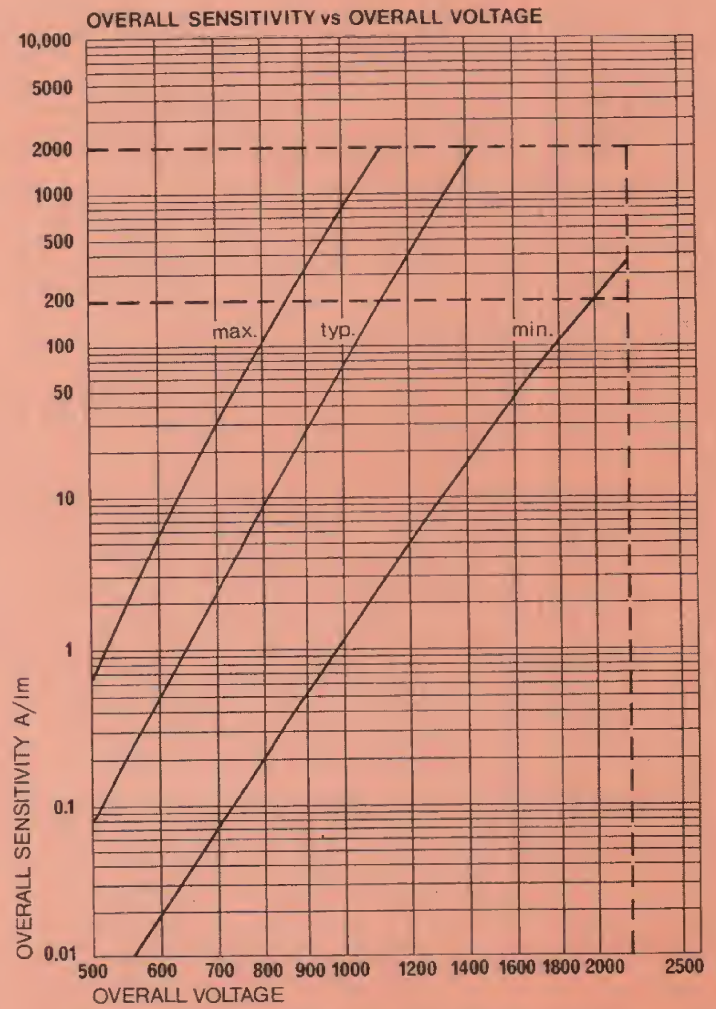

APPARENT VARIATION OF CATHODE DARK CURRENT WITH TEMPERATURE FOR TYPICAL PHOTOMULTIPLIER TUBES

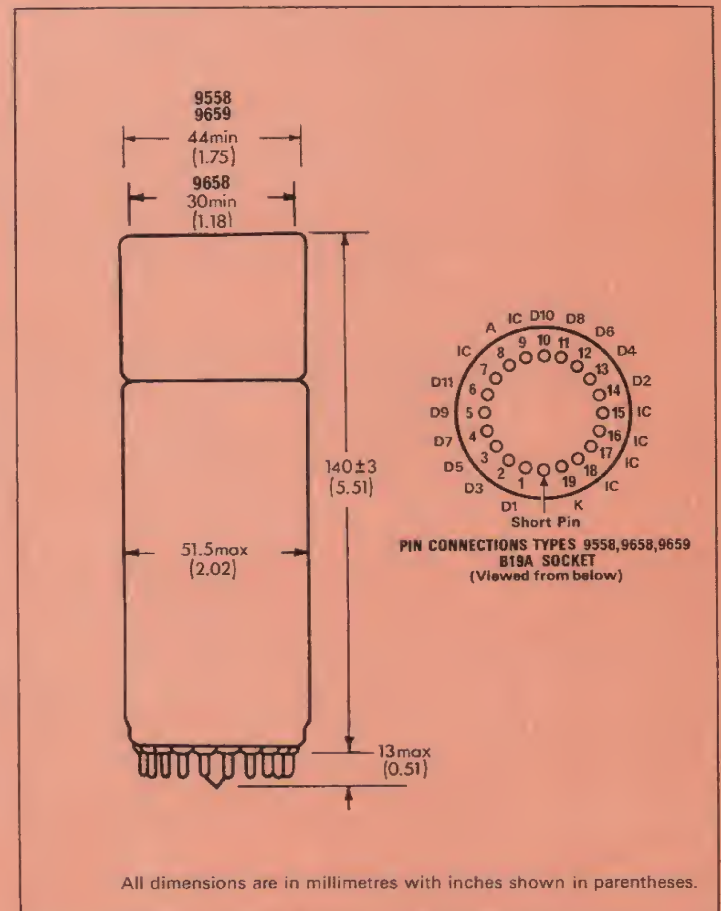
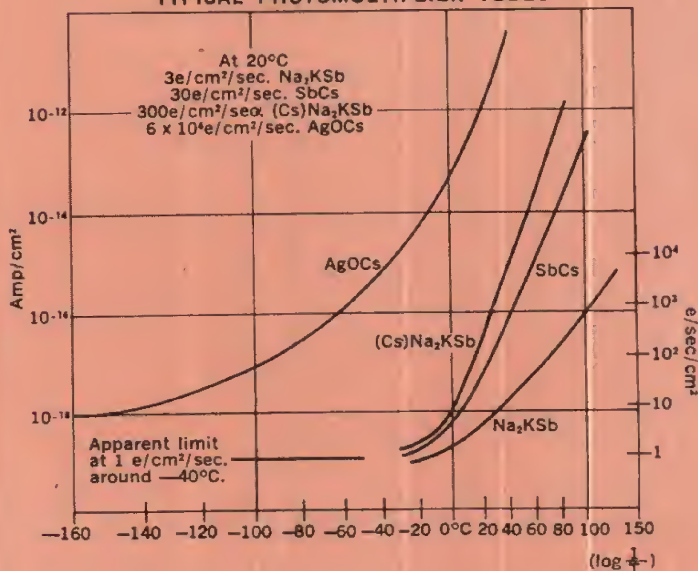

All dimensions are in millimetres with inches shown in parentheses.

50mm tubes 10mm effective cathode area

The EMI photomultiplier type 9502B is a 50 mm (2 in.) nominal diameter tube with very high gain (ca. 10^8) having 13 venetian blind dynodes with extremely stable CsSb secondary emitting surfaces. These tubes have a cathode diameter of 10 mm min. and employ a unique K-D1 geometry which results in very low dark currents at high overall sensitivity, (typically 2nA at 2000A/lm). The cathode is of the S-11 or CsSbO type giving a typical range of peak quantum efficiencies of between 17.5 and 20% at about 4000Å.

For very low light level applications, the 9502S is available with the unique EMI "S" cathode. This tube has a typical dark current of about 0.3nA at 2000A/lm. The thermionic emission is reduced by special processing and some cathode sensitivity is sacrificed due to reduced red sensitivity.

For applications in the near ultraviolet, these tubes are available with Spectrosil (fused silica) windows as types 6256B and 6256S respectively. This extends the useful range down to about 1650Å. For those applications where the high gain of the 9502 is not required, but where the small cathode area and low dark current are important, the 6094B or the 6094S should be chosen.

The normal low dark currents of these tubes can be further reduced by cooling and a reduction of 10:1 is easily obtained by cooling to dry ice temperature. Care should be taken to cool slowly and uniformly in order to minimise thermal shock. The entire tube should be cooled, not just the cathode, and condensation of moisture at the base must be avoided (see R/P021/CP5475 available on request).

Notes

- 1 a) Each tube is individually calibrated and the test ticket furnished with the tube specifies the cathode sensitivity in $\mu\text{A/lm}$, the overall voltage at 200 A/lm (6094) or 2000 A/lm (9502, 6256) and the dark current at that overall sensitivity at 20°C.
b) Test data is obtained with cathode -D1 voltage held at 150V and a "Standard" dynode chain.*
c) In general, when setting up experiments or designing for equipment, it is desirable to work at, or below, the ticket voltage of the individual tube.
d) For highest stability in d.c. conditions, mean anode current should not exceed 10 μA .
- 2 Any material in contact with the glass envelope must be held at cathode potential. Failure to do so may result in erratic operation and high dark current.
- 3 Take great care in clamping tubes, particularly those with Spectrosil (fused silica) windows. Excess pressure may fracture the glass in which case the warranty is void.
- 4 Photomultipliers are affected by magnetic fields and mu-metal shields should be used, (see page 64).
- 5 When cooling below -40°C the standard Teflon socket should not be used as it may deform and crack the glass. Instead, each pin should be connected separately and individual hyperboloidal contacts are available from EMI for this purpose.

*For recommended dynode chains, refer to Groups H, I, J (6094) and Groups K, L, M (9502, 6256) on page 14.

MECHANICAL CHARACTERISTICS

Max. envelope dia.	51.5 mm (2.02 in)			
Min. cathode dia.	10 mm (0.39 in)			
Cathode type	6094B 6094S	9502B 9502S	S-11 "S"	6256B 6256S
Window material	6094 9502 Lime Soda 6256 Spectrosil (fused silica)			
Dynodes	6094 (11 stages); 9502, 6256 (13 stages): venetian blind dynodes with CsSb secondary emitting surfaces			
Base	Low loss 15-pin pressed glass base furnished with high quality Teflon socket type B15B			

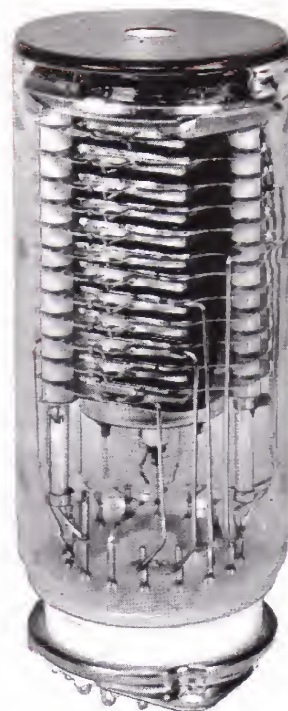

ELECTRICAL RATINGS

	6094	6256 9502		
Cathode to D1	300V Max.	300V Max.		
Recommended cathode to D1 voltage	150V	150V		
Cathode to anode (subject to not exceeding)	2200V Max. 2000A/lm	2500V Max. 5000A/lm		
Overall sensitivity: Rated Max.	200A/lm 2000A/lm	2000A/lm 5000A/lm		
Max. anode current (mean)	1 mA	1 mA		
Max. anode dissipation	1 W	1 W		
Max. tolerable cathode current	3 μA	3 μA		
Max. operating temperature	60°C	60°C		
Min. operating temperature	-80°C	-80°C		
Anode pulse rise time	8 ns	10 ns		
Anode pulse f.w.h.m.	14 ns	15 ns		
Transit time	45 ns	55 ns		
Capacitance, anode to all dynodes	8 pF	8 pF		
Dark current shot noise Typical (λ peak)	6094B 6094S	6256B 9502B 6256S	9502S 6256S	
lumens:	1.1×10^{-13}	4.6×10^{-14}	6.3×10^{-14}	2.8×10^{-14}
watts:	1.3×10^{-16}	5.6×10^{-17}	8.5×10^{-17}	3.5×10^{-17}

Cathode Sensitivity $\mu\text{A/lm}$ Min. Typ.	Overall Sensitivity 200A/lm				Overall Sensitivity 2000A/lm					
	V		Dark Current nA		V		Dark Current nA			
	Typ.	Max.	Typ.	Max.	Typ.	Max.	Typ.	Max.		
6094B	50	70	1350	1800	0.5	5	1850	—	5	—
6094S	40	60	1450	1800	0.08	0.1	1950	—	0.8	—
			2000A/lm				5000A/lm			
9502B 6256B	50	80	1500	2100	2	15	1650	—	5	—
9502S 6256S	40	60	1600	2100	0.3	1	1750	—	0.8	—

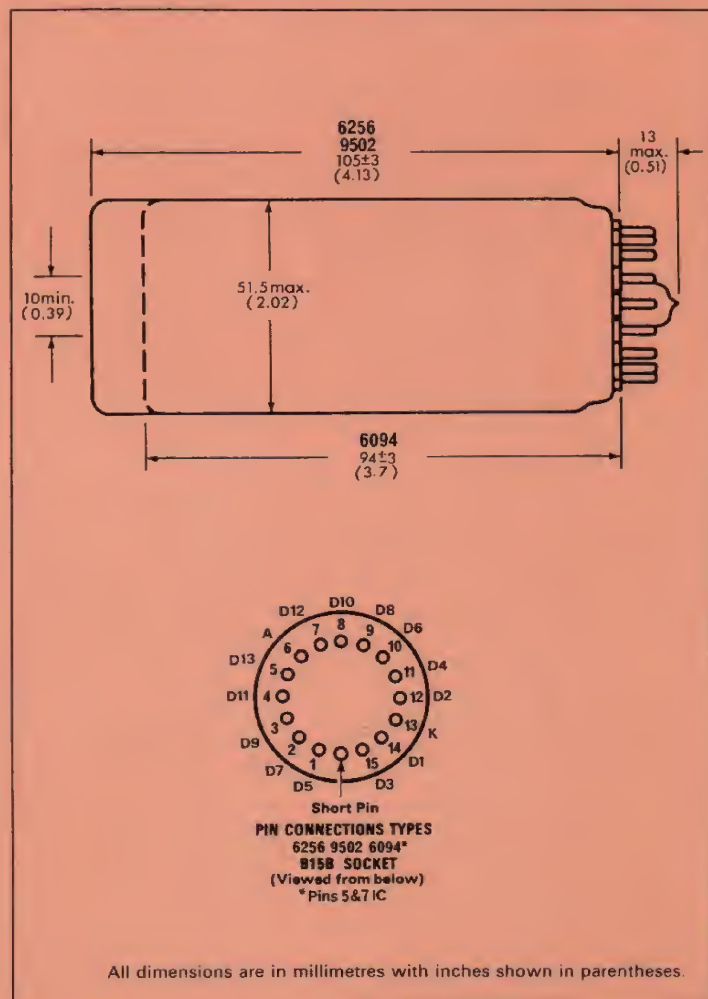
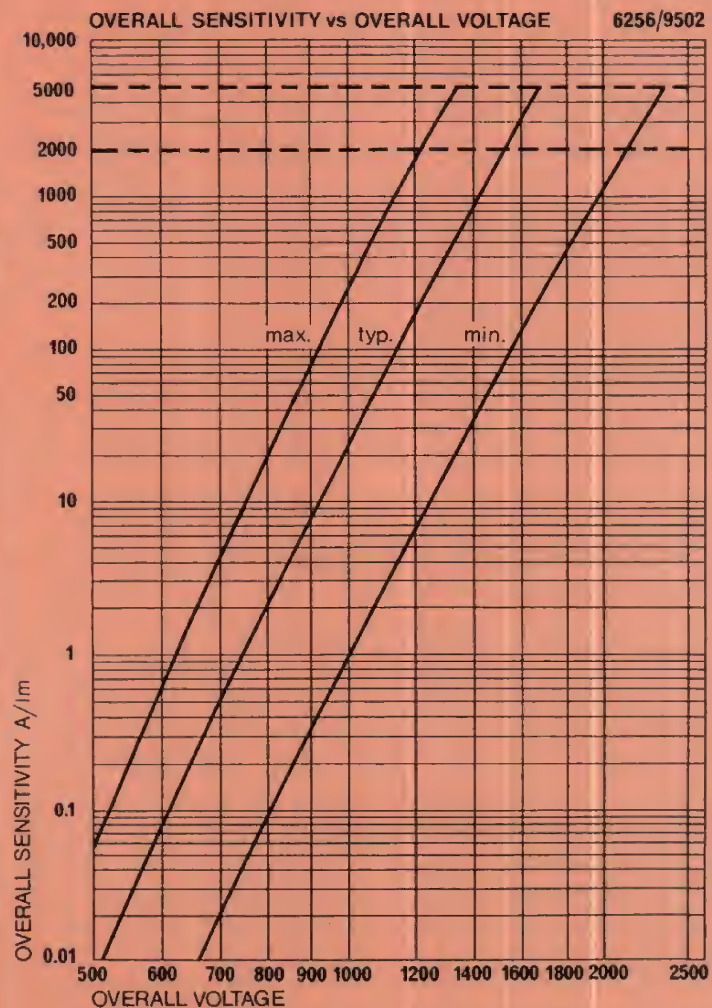
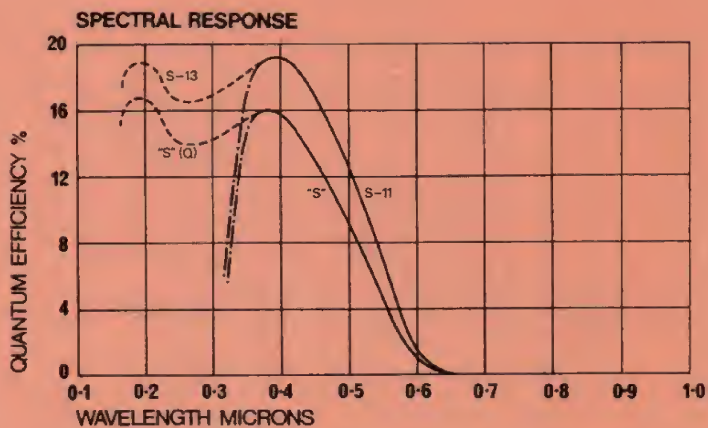
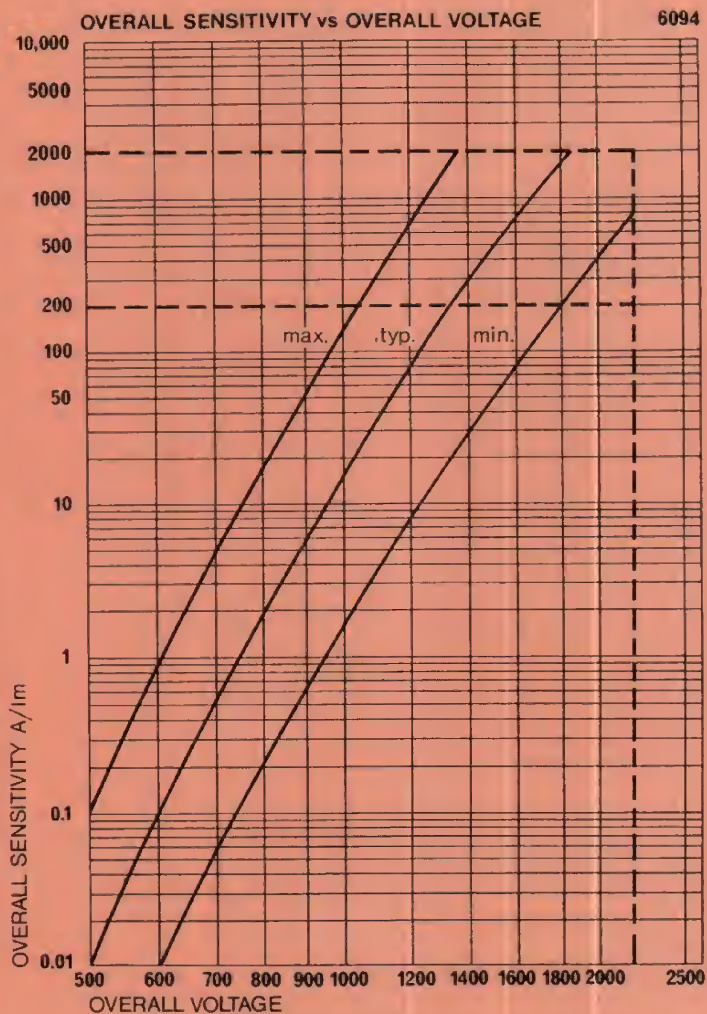

All dimensions are in millimetres with inches shown in parentheses.

50mm tubes "bialkali" cathodes

The EMI types 9635 and 9750 are 50 mm (2 in.) nominal diameter photomultiplier tubes having bialkali (SbKCs) photocathodes with quantum efficiencies ranging from 20 to 32% at the peak wavelength of 3800Å. The 9635 has 13 venetian blind dynodes and the 9750 has 10, both systems employing the highly stable and efficient CsSb secondary emitting surfaces developed by EMI. With this dynode system and the very efficient bialkali cathode, the 9635B and 9750B are capable of giving high values of gain with extremely low dark currents.

The standard "B" grade versions have borosilicate windows giving a spectral range from ca. 2850 to 6500Å. "QB" versions are also available with Spectrosil (fused silica) windows for applications in the UV down to ca. 1650Å or for low level scintillation counting due to the low natural radioactivity in the window. The 9750B and 9750QB are available overcapped with a B14A base as types 9750KB and 9750QKB respectively.

The 9635QB is used in the majority of liquid scintillation systems throughout the world. The 9750 is suitable for a wide range of photo-optical applications such as flying spot scanners, densitometers and photometric instruments. Both types also find extensive use in thermoluminescent dosimetry and gamma and X-ray spectrometry.

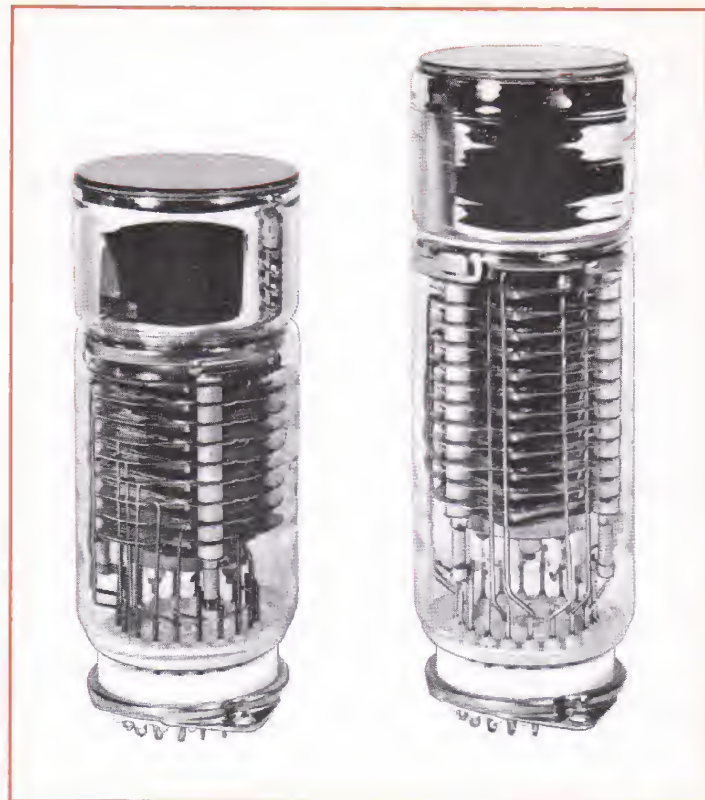

Notes

- 1 a) Each tube is individually calibrated, and the test ticket furnished with the tube gives a measurement of cathode blue sensitivity referred to the usual standard source with a Corning CS-5-58 filter (polished to half stock thickness) interposed. The quantum efficiency at 4200Å can be calculated from the sensitivity with the Corning blue filter by multiplying by 2.50. The usual figures for cathode sensitivity in $\mu\text{A}/\text{lm}$ and the dark current (at 20°C) and voltage corresponding to 2000 A/lm (9635) or 50 A/lm (9750) are also entered.
 - b) Test data is obtained with cathode -D1 volts held at 150V and a "Standard" dynode chain.*
 - c) In general, when setting up experiments or designing for equipment, it is desirable to work at, or below, the ticket voltage of the individual tube.
 - d) For highest stability in d.c. conditions, mean anode current should not exceed 10 μA .
 - 2 Any material in contact with the glass envelope must be held at cathode potential. Failure to do so may result in erratic operation and high dark current.
 - 3 Take great care in clamping tubes, particularly those with Spectrosil (fused silica) windows. Excess pressure may fracture the glass in which case the warranty is void.
 - 4 Photomultiplier tubes are affected by magnetic fields and mu-metal shields should be used, (see page 64).
- * For recommended dynode chains refer to Groups K, L, M (9635) or Groups D', E', F' (9750) on page 14.

MECHANICAL CHARACTERISTICS

Max. envelope dia.	51.5 mm (2.02 in)
Min. cathode dia.	44 mm (1.73 in)
Cathode type	Bialkali (SbKCs)
Window material	9750B 9635B Borosilicate 9750QB 9635QB Spectrosil (fused silica)
Dynodes	9750 (10 stages); 9635 (13 stages): venetian blind dynodes with CsSb secondary emitting surfaces
Base	Low loss 19-pin pressed glass base furnished with high quality Teflon socket type B19A. Tubes with "K" suffix overcapped with diheptal base type B14A

ELECTRICAL RATINGS

	9635	9750
Cathode to D1	300V Max.	300V Max.
Recommended cathode to D1 voltage	150V	150V
Cathode to anode (subject to not exceeding)	2500V Max. 5000A/lm	2000V Max. 500A/lm
Overall sensitivity: Rated Max.	2000A/lm 5000A/lm	50A/lm 500A/lm
Max. anode current (mean)	1 mA	1 mA
Max. anode dissipation	1W	1W
Max. tolerable cathode current	0.3 μA	0.3 μA
Max. operating temperature	60°C	60°C
Min. operating temperature	-5°C*	-5°C*
Anode pulse rise time	10 ns	7 ns
Anode pulse f.w.h.m.	25 ns	16 ns
Transit time	60 ns	50 ns
Capacitance, anode to all dynodes	8 pF	8 pF
Dark current shot noise Typical (λ peak)	lumens: 8.0×10^{-14} watts: 7.2×10^{-17}	1.4×10^{-13} 1.1×10^{-16}

* For systems operating below -5°C the 9634QR is to be preferred.

	Cathode Sensitivity with Corning Blue filter interposed		Cathode Sensitivity $\mu\text{A}/\text{lm}$ Typ.	Overall Sensitivity 2000A/lm				Overall Sensitivity 5000A/lm			
	Min.	Typ.		V Overall Typ.	V Overall Max.	Dark Current nA Typ.	Dark Current nA Max.	V Overall Typ.	V Overall Max.	Dark Current nA Typ.	Dark Current nA Max.
9635B	7.0	9.5	75	1200	1800	3	15	1300	—	7.5	—
9635QB	9.0	10.0	75	1200	1800	3	15	1300	—	7.5	—
				50A/lm				500A/lm			
9750B	7.0	9.5	70	900	1400	0.2	2	1200	—	2	—
9750QB	7.0	9.5	70	900	1400	0.2	2	1200	—	2	—

The maximum dark current rate for all types is 1000 electrons/sec.

OVERALL SENSITIVITY vs OVERALL VOLTAGE

9750

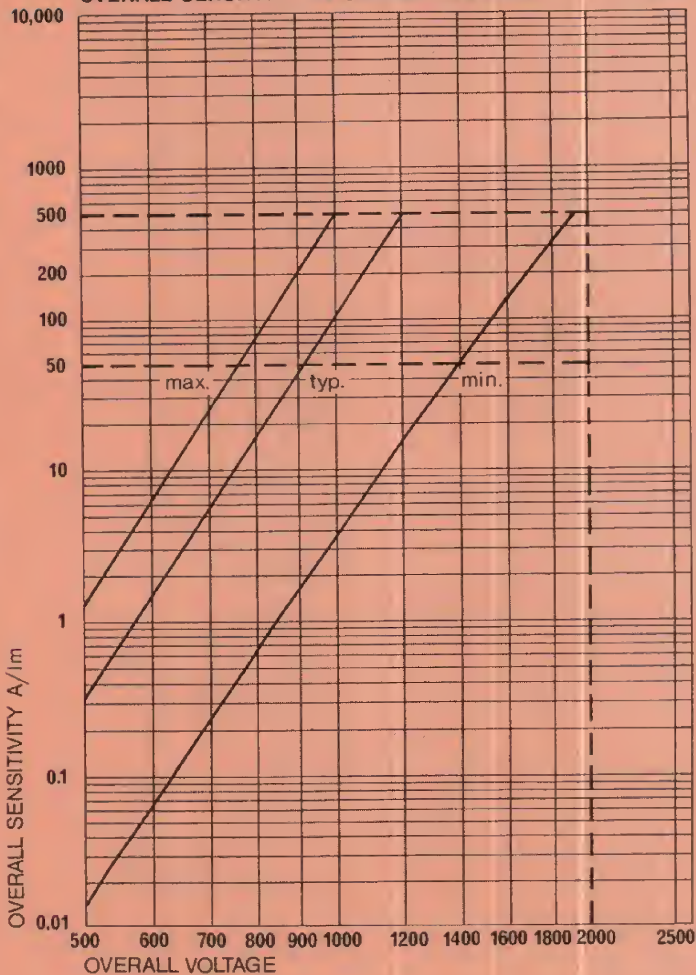

SPECTRAL RESPONSE

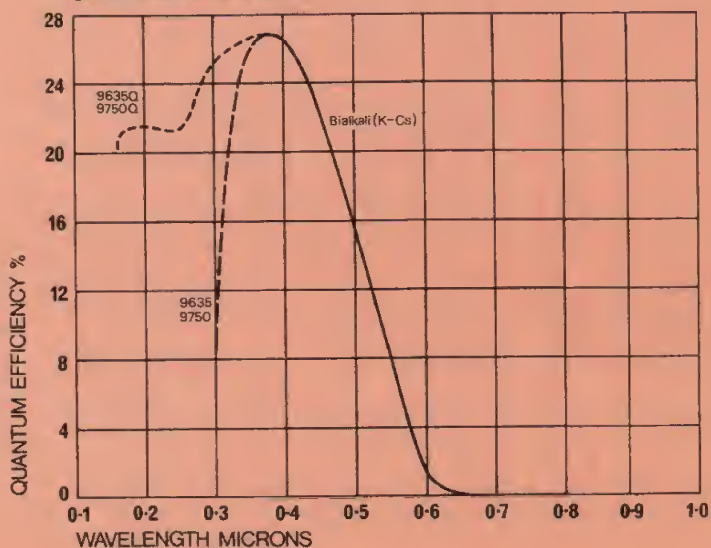

OVERALL SENSITIVITY vs OVERALL VOLTAGE

9635

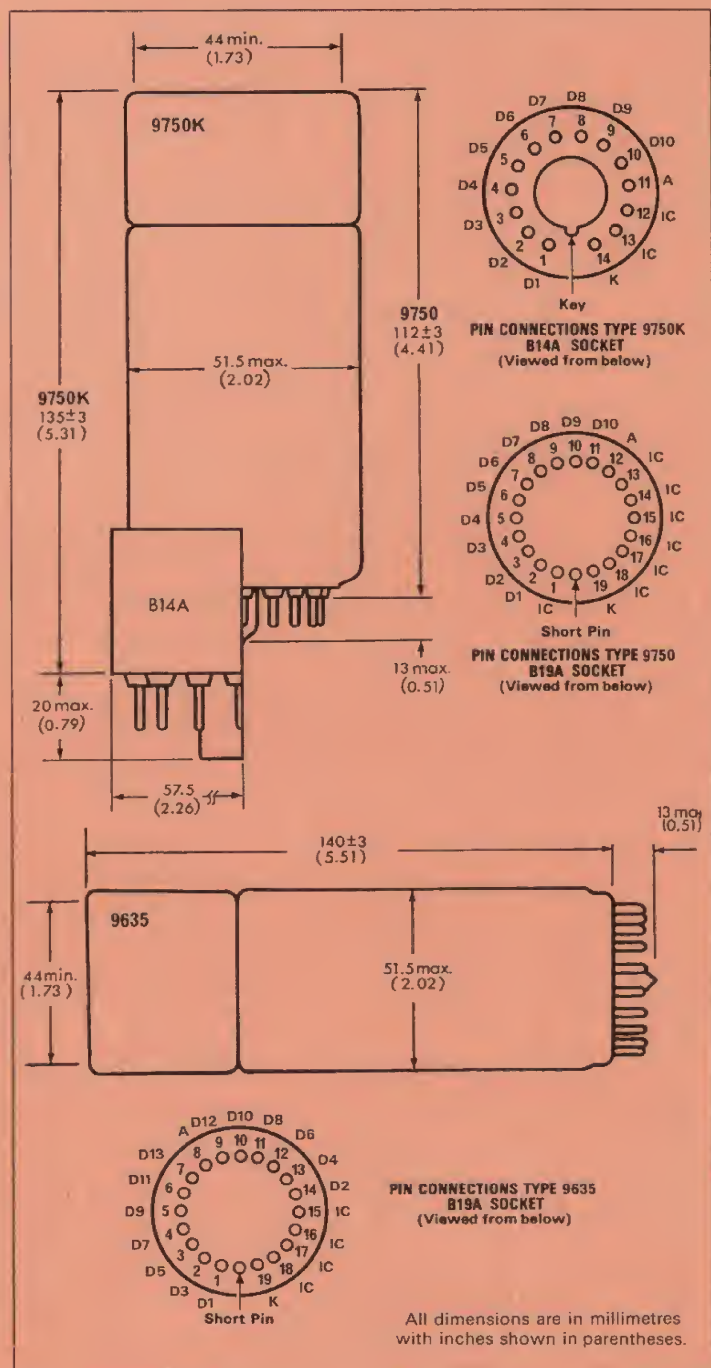
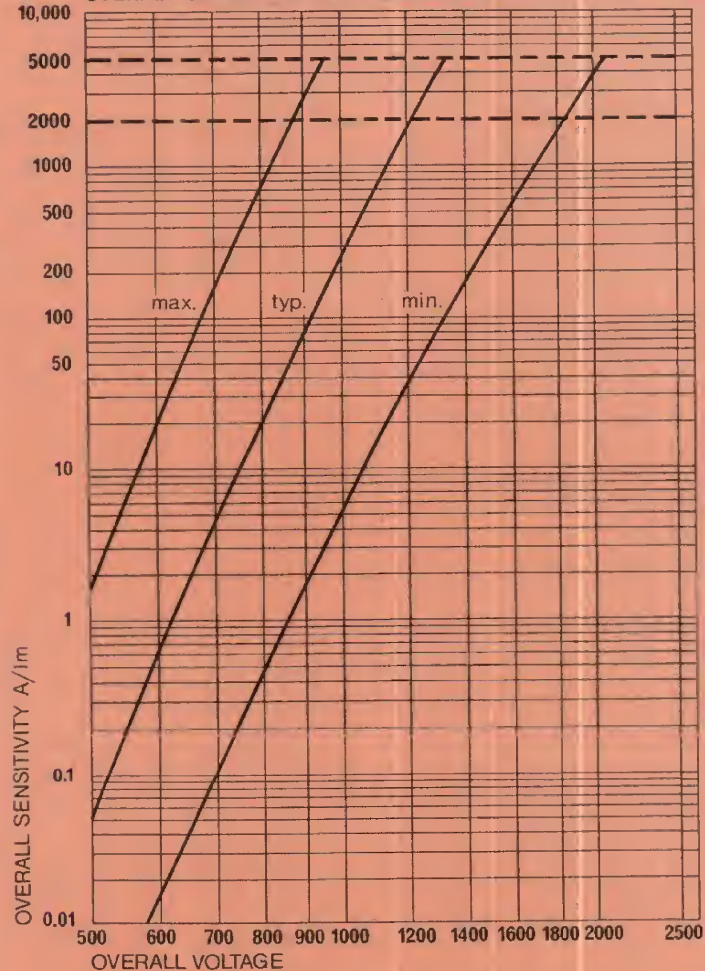

All dimensions are in millimetres with inches shown in parentheses.

Tubes with extended cathodes for 2π sensitivity

This family of tubes was developed primarily to meet the needs of nucleonic instrument companies manufacturing various types of scintillation probes. The extended cathode area of these types when combined with rudimentary integrating spheres makes possible a substantial reduction in probe size without the loss of efficiency. They are also useful in applications such as character readers . . . etc., where there is an advantage in being able to collect light at the side as well as at the end of the tube.

The 9600B is a 30 mm (1 in.) nominal diameter type with an S-11 cathode and incorporates the EMI box and grid dynode system, having 11 stages, with CsSb secondary emitting surfaces. It has an effective cathode area of about 20 cm² (3 in.²).

The 9638B is a 50 mm (2 in.) nominal diameter type with an S-11 cathode. The dynode system consists of 11 venetian blind stages with the highly stable CsSb secondary emitting surfaces. The effective cathode area of the 9638B is about 45 cm² (7 in.²).

The 9726B is a very short variant of the 9638B, having only 6 venetian blind dynodes, and the same cathode area. It finds application where only a fairly low level of gain is needed and space and power are limited. It can be supplied overcapped with a diheptal base as 9726KB.



Notes

- 1 a) Each tube is individually calibrated and the test ticket furnished with each tube specifies the cathode sensitivity in $\mu\text{A}/\text{lm}$, the overall voltage for 200 A/lm (9600B, 9638B) or 1 A/lm (9726B) and the dark current at that overall sensitivity at 20°C.
- b) Test data is obtained with cathode -D1 at 150 volts, and a linear dynode chain.*
- c) In general, when setting up experiments or designing for equipment, it is desirable to work at, or below, the ticket voltage of the individual tube.
- d) For highest stability in d.c. conditions, mean anode current should not exceed 2 μA (9600B) or 10 μA (9638B, 9726B).
- 2 Any material in contact with the glass envelope must be held at cathode potential. Failure to do so may result in erratic operation and high dark current.
- 3 Take great care in clamping tubes. Excess pressure may fracture the glass in which case the warranty is void.
- 4 Photomultipliers are affected by magnetic fields and mu-metal shields should be used, (see page 64).

* For recommended dynode chains refer to Groups H, I, J* (9600) or Groups H, I, J (9638) or Groups A, B, C (9726), on page 14.

MECHANICAL CHARACTERISTICS

	9600B	9638B	9726B
Max. envelope dia.	29 mm	51.5 mm	51.5 mm
Min. cathode dia.	23 mm	44 mm	44 mm
Cathode type	S-11 (all types)		
Sidewall sens. approx.	20 mm	30 mm	30 mm
Window material	Lime Soda	Borosilicate	Borosilicate
Dynodes	11 BG (all have CsSb secondary emitting surfaces)	11 VB	6VB
Base	B14B	B19A	B15B

All have low loss pressed glass bases and are furnished with the appropriate high quality Teflon socket. 9726KB is overcapped with diheptal base type B14A; socket not supplied

ELECTRICAL RATINGS

	9600B	9638B	9726B
Cathode to D1	300V Max.	300V Max.	300V Max.
Recommended cathode to D1 voltage	150V	150V	150V
Cathode to anode (subject to not exceeding 200A/lm)	1600V Max.	2000V Max.	2000V Max.
Overall sensitivity: Rated Max.	200A/lm 200A/lm	200A/lm 500A/lm	1A/lm 5A/lm
Max. anode current (mean)	0.5mA	1 mA	1 mA
Max. anode dissipation	0.5W	1W	1W
Max. tolerable cathode current	0.2 μA	0.5 μA	0.5 μA
Max. operating temp.	60°C (all types)		
Min. operating temp.	-80°C (all types)		
Anode pulse rise time	18 ns	10 ns	10 ns
Anode pulse f.w.h.m.	38 ns	15 ns	14 ns
Transit time	70 ns	55 ns	40 ns
Capacitance, anode to all dynodes	6 pF	8 pF	8 pF
Dark current shot noise Typical (λ peak)	lumens: 3.4×10^{-13} watts: 4.0×10^{-16}	3.4×10^{-13} 4.0×10^{-16}	6.8×10^{-13} 7.9×10^{-16}

	Cathode Sensitivity $\mu\text{A}/\text{lm}$ Min. Typ.		Overall Sensitivity 200A/lm				Overall Sensitivity 500A/lm			
			V Overall		Dark Current nA		V Overall		Dark Current nA	
			Typ.	Max.	Typ.	Max.	Typ.	Max.	Typ.	Max.
9600B	50	70	950	1250	5	50	—	—	—	—
9638B	50	70	1200	1800	5	50	1350	—	12.5	—
			1A/lm				5A/lm			
9726B	50	70	1200	1800	0.1	5	2000	—	0.5	—

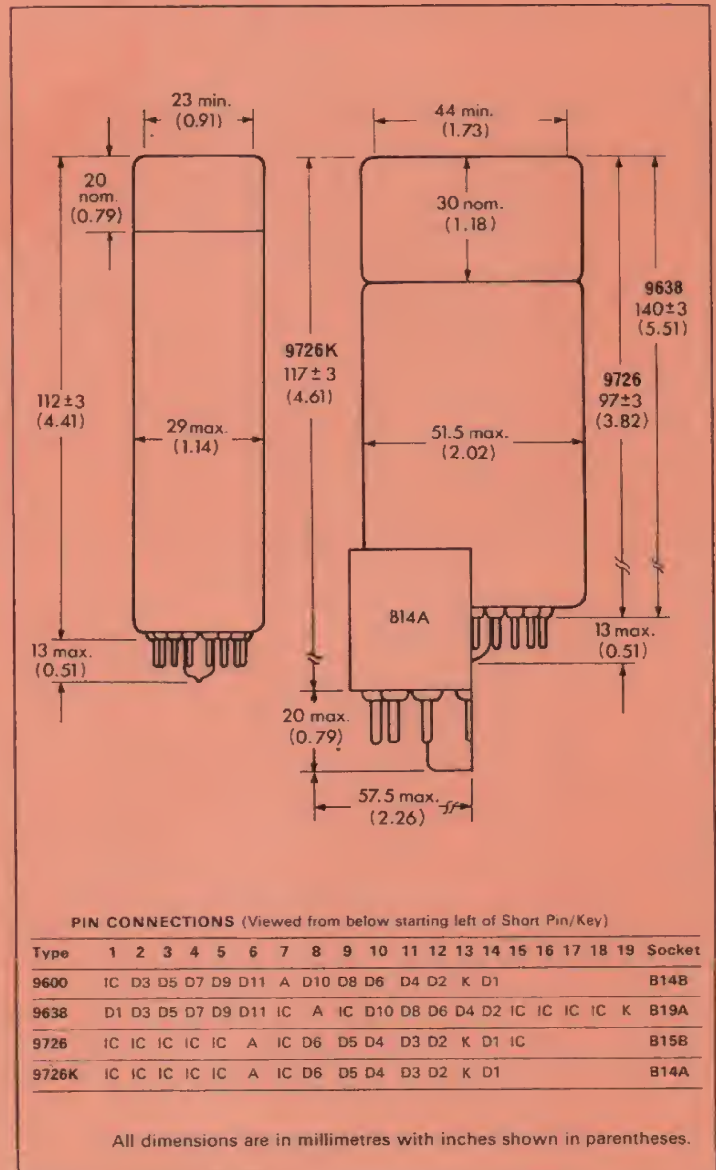
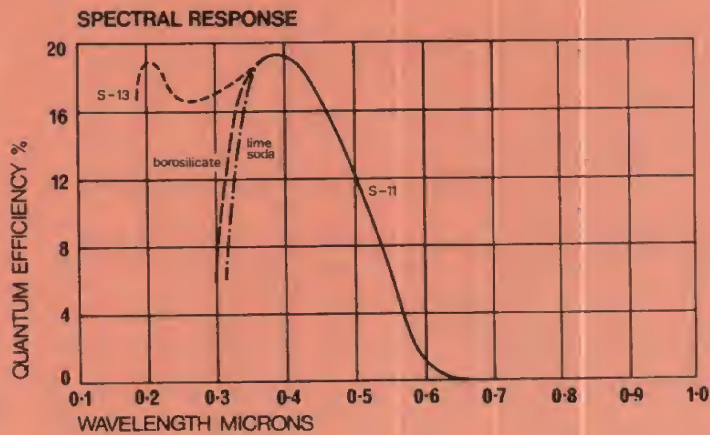
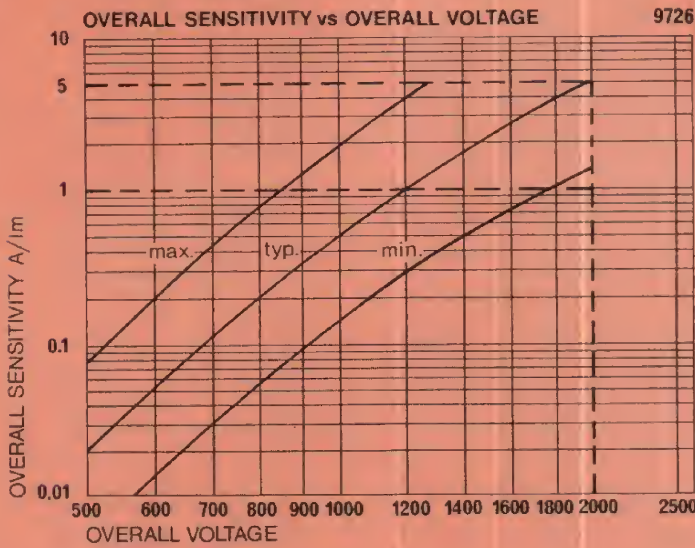
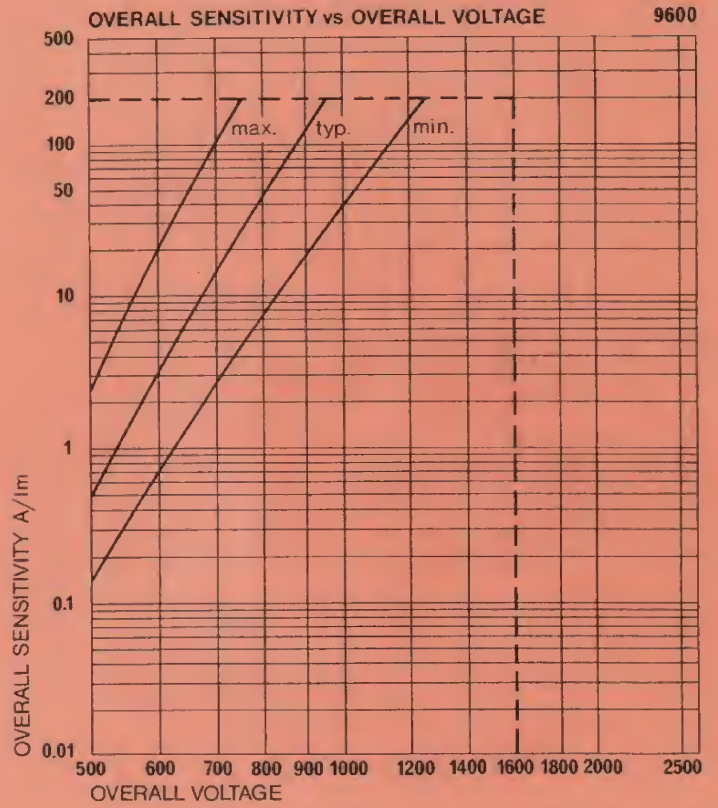
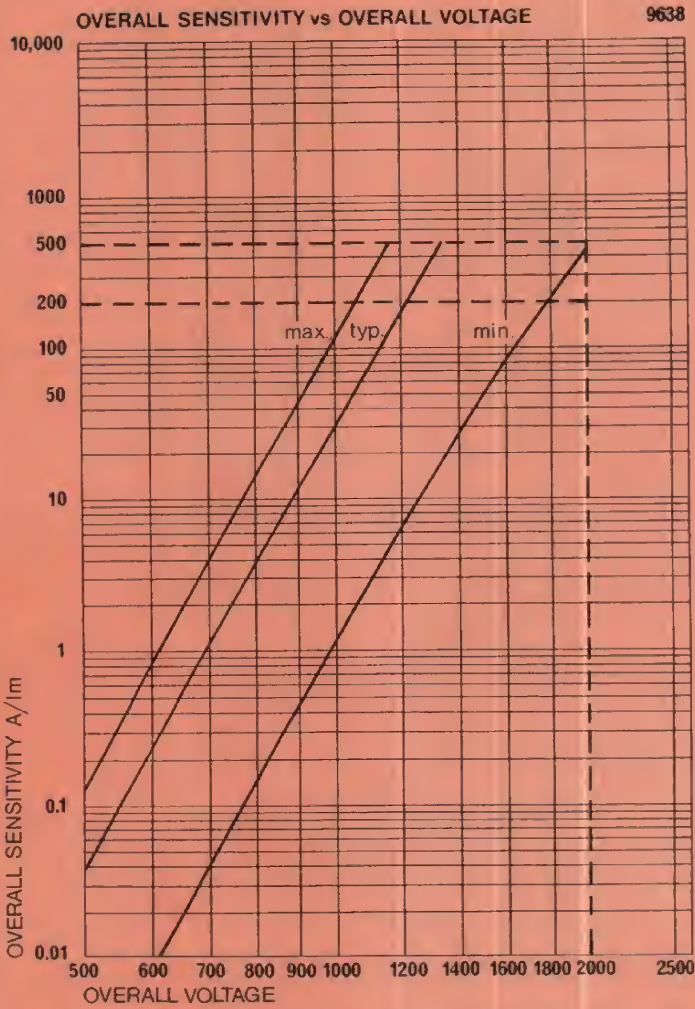

Special high temperature photomultipliers

The 9727B is a 50 mm (2 in.) nominal diameter end-on, flat-faced photomultiplier especially designed for operation at temperatures up to ca. 150°C.

The photocathode is the special antimony potassium sodium (SbKNa) type giving a peak quantum efficiency of ca. 20% at 3500Å. The dynode system comprises 13 venetian blind stages with AgMgO secondary emitting surfaces.

The 9727B finds its principal application in oil well logging, but is equally useful in any similar application where stability of gain and dark current with temperature are of prime importance.

The 9700B is a 30 mm (1 in.) nominal diameter flat-faced end-on tube having the same cathode, but is fitted with 9 box and grid dynodes again with AgMgO secondary emitting surfaces. Its applications are generally similar, and it should only be used when there is a space limitation.



Notes

- 1 a) Each tube is individually calibrated and the test ticket furnished with the tube specifies the cathode sensitivity in $\mu\text{A}/\text{lm}$, the overall voltage at 50 A/lm (9727B) or 5 A/lm (9700B) and the dark current at that overall sensitivity at 20°C.
 - b) Test data is obtained with cathode -D1 voltage held at 150V and a "Standard" dynode chain.*
 - c) In general, when setting up experiments or designing for equipment, it is desirable to work at, or below, the ticket voltage of the individual tube.
 - d) For highest stability in d.c. conditions, mean anode current should not exceed 2 μA (9700B) or 10 μA (9727B).
 - 2 Any material in contact with the glass envelope must be held at cathode potential. Failure to do so may result in erratic operation and high dark current.
 - 3 Take great care in clamping tubes. Excess pressure may fracture the glass in which case the warranty is void.
 - 4 Photomultipliers are affected by magnetic fields and mu-metal shields should be used, (see page 64).
- * For recommended dynode chains refer to Groups D, E, F (9700) and Groups K, L, M (9727) on page 14.

MECHANICAL CHARACTERISTICS

	9727B	9700B
Max. envelope dia.	51.5 mm (2.02 in)	29 mm (1.14 in)
Min. cathode dia.	44 mm (1.73 in)	23 mm (0.91 in)
Cathode type	SbKNa	SbKNa
Window material	Borosilicate	Borosilicate
Dynodes	13VB (AgMgO secondary emitting surfaces)	9BG
Base	B19A	B14B
	Low loss pressed glass base furnished with appropriate high quality Teflon socket	

ELECTRICAL RATINGS

	9727B	9700B
Cathode to D1	300V Max.	300V Max.
Recommended cathode to D1 voltage	150V	150V
Cathode to anode (subject to not exceeding)	3500V Max. 200A/lm	2500V Max. 20A/lm
Overall sensitivity: Rated Max.	50A/lm 200A/lm	5A/lm 20A/lm
Max. anode current (mean)	1 mA	100 μA
Max. anode dissipation	1 W	0.1 W
Max. operating temperature	150°C	150°C
Min. operating temperature	-80°C	-80°C
Anode pulse rise time	8 ns	25 ns
Anode pulse f.w.h.m.	18 ns	40 ns
Transit time	55 ns	70 ns
Capacitance, anode to all dynodes	8 pF	6 pF
Dark current shot noise Typical (λ peak)	lumens: 2.8×10^{-13} watts: 1.9×10^{-16}	2.1×10^{-13} 1.0×10^{-16}

	Cathode Sensitivity $\mu\text{A}/\text{lm}$	Min.	Typ.	Overall Sensitivity 50A/lm		Overall Sensitivity 200A/lm				
				V Overall Typ.	Dark Current nA Typ. Max.	V Overall Typ.	Dark Current nA Typ. Max.			
9727B	25	40	1500	2500	0.5	5	1750	—	2	—
9700B	20	30	5A/lm		20A/lm					
			1800	2500	0.02	1	2200	—	0.08	—

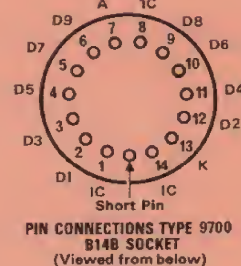
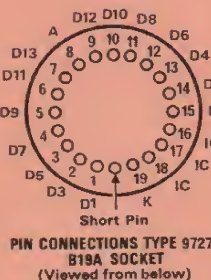
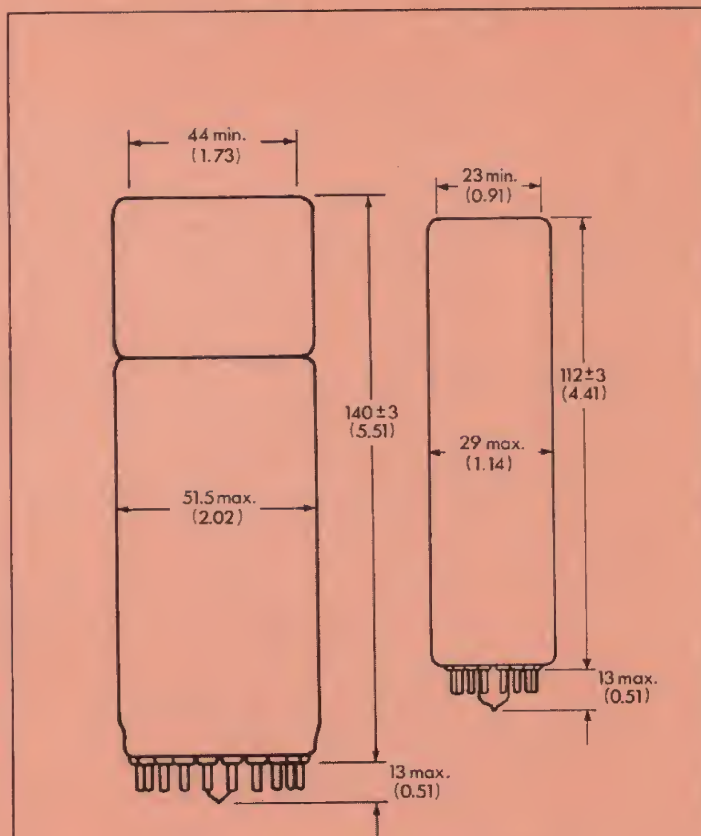
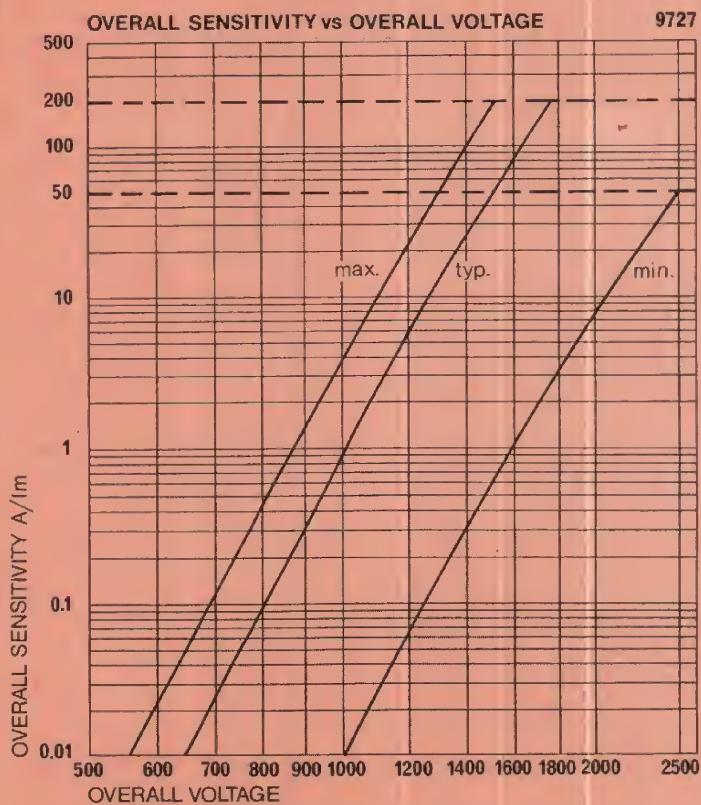
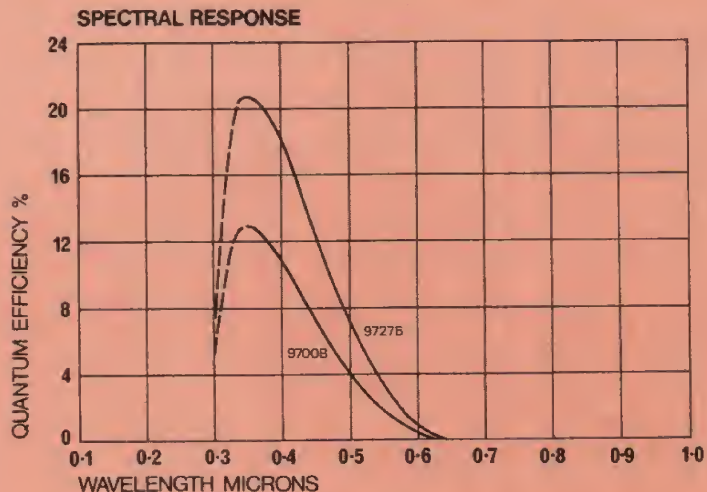
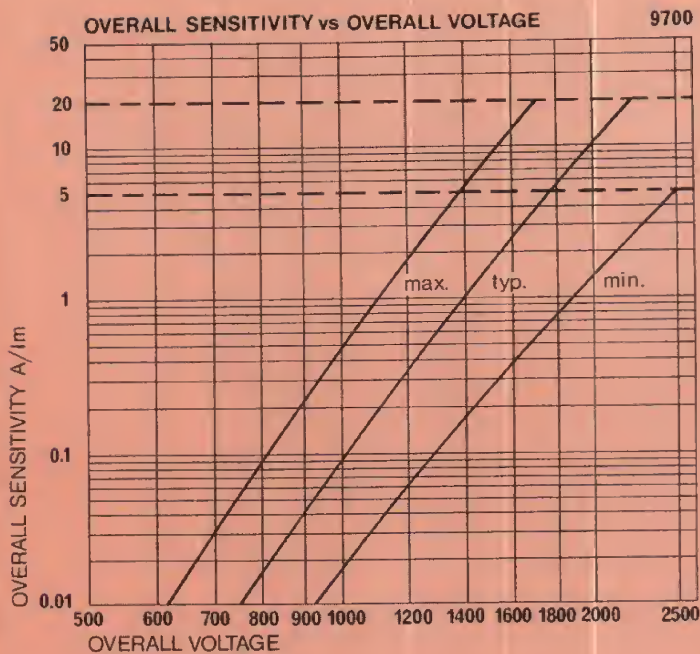

All dimensions are in millimetres with inches shown in parentheses.

75mm tubes, S-11 and Super S-11 cathodes

The 9708 series have 9 venetian blind dynodes with CsSb secondary emitting surfaces. The focus electrode in the earlier 10-stage type 9578 has been eliminated due to improvements in the K-D1 geometry. This gives improved resolution and because only 9 dynodes are now employed, there has been an increase in cathode sensitivity and a reduction in seated height. However, the 9708KB can be plugged directly into 9578 or other 10-stage tube sockets without modification and the interdynode voltages will conform to the new recommended distribution.

The 9708R incorporates the "Super" S-11 cathode and is resolution tested with our standard factory NaI-Tl crystal. Each tube must give a peak to valley ratio for Co⁶⁰ of not less than 7:1. For multiple installations in gamma and X-ray spectrometry units, the narrow spread in gain of this type is a great advantage.

Another variant type 9708L is available to special order, with the same resolution specification as the 9708R but with a lower minimum photocathode sensitivity. For less stringent applications the 9708B can be supplied at lower cost.

For those applications where it is desirable to extend the spectral response into the ultraviolet, or where radioactivity in the window may be objectionable, the 9708QR and 9708QB, with quartz windows are available to special order. All types can be supplied overcapped with a diheptal base, e.g. 9708KB.

Variants of this tube are also available to special order with S-1 and S-20 photocathodes, having the same pin connections as the 9708, but which are longer overall. These are designated types 9710B and 9710TB respectively. The 9710B has AgMgO dynodes and the Spectral Response curve is shown on page 33.



Notes

- Each tube is individually calibrated and the test ticket furnished with the tube specifies the cathode sensitivity in $\mu\text{A}/\text{lm}$, the overall voltage at 50A/lm and the dark current at that overall sensitivity at 20°C.
 - Test data is obtained with cathode -D1 voltage held at 300V and a "Standard" dynode chain.*
 - In general, when setting up experiments or designing for equipment, it is desirable to work at, or below, the ticket voltage of the individual tube.
 - For highest stability in d.c. conditions, mean anode current should not exceed 10 μA .
- Any material in contact with the glass envelope must be held at cathode potential. Failure to do so may result in erratic operation and high dark current.
- Take great care in clamping tubes, particularly those with quartz bulbs. Excess pressure may fracture the glass in which case the warranty is void.
- Photomultipliers are affected by magnetic fields and mu-metal shields should be used, (see page 64).

* For recommended dynode chains, refer to Groups D, E, F on page 14.

MECHANICAL CHARACTERISTICS

Max. bulb dia.	78 mm (3.07 in)
Max. neck dia.	54 mm (2.13 in)
Min. cathode dia.	65 mm (2.56 in)
Cathode type	9708R "Super" S-11 9708L S-11 9708B S-11 9708QR "Super" S-13
Window material	9708 Borosilicate 9708Q Quartz (to special order)
Dynodes	9 venetian blind with CsSb secondary emitting surfaces
Base	Low loss 19-pin pressed glass base furnished with high quality Teflon socket type B19A. "K" type overcapped with diheptal base type B14A; socket not furnished

ELECTRICAL RATINGS

Cathode to D1	350V Max.
Recommended cathode to D1 voltage	300V
Cathode to anode (subject to not exceeding)	2100V Max. 200A/lm)
Overall sensitivity: Rated Max.	50A/lm 200A/lm
Max. anode current (mean)	1 mA
Max. anode dissipation	1W
Max. tolerable cathode current	1 μA
Max. operating temperature	60°C
Min. operating temperature	-80°C
Anode pulse rise time	12 ns
Anode pulse f.w.h.m.	50 ns
Transit time	70 ns
Capacitance, anode to all dynodes	8 pF
Dark current shot noise Typical (λ peak)	lumens: 9708R 4.2×10^{-13} 9708B 4.9×10^{-13} watts: 9708R 6.0×10^{-16} 9708B 6.5×10^{-16}

Cathode Sensitivity $\mu\text{A}/\text{lm}$	Overall Sensitivity 50A/lm				Overall Sensitivity 200A/lm					
	Min.	Typ.	V Overall Typ.	Dark Current nA Max.	V Overall Typ.	Dark Current nA Max.	V Overall Typ.	Dark Current nA Max.		
9708R	80	110	1300	1500	3	20	1550	—	12	—
9708L	50	105	1300	1750	3	50	1550	—	12	—
9708B	50	80	1300	1750	3	50	1550	—	12	—

Resolution: 9708R and 9708L must give a minimum peak/valley ratio for Co⁶⁰ of 7:1 with standard factory crystal.

OVERALL SENSITIVITY vs OVERALL VOLTAGE

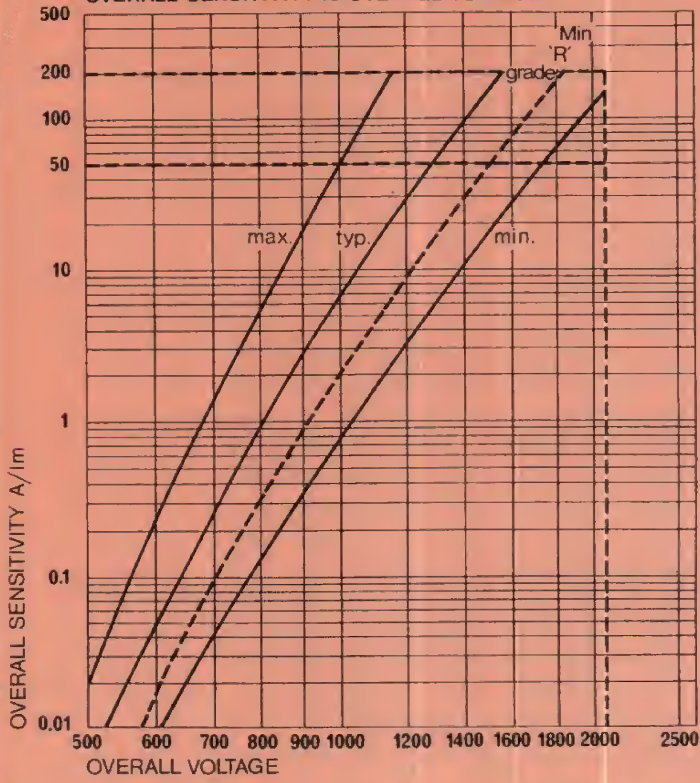

SPECTRAL RESPONSE

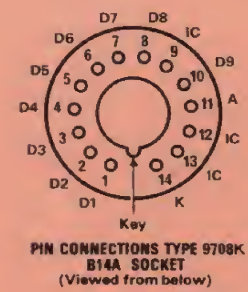
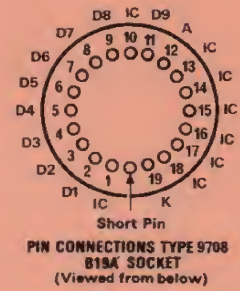
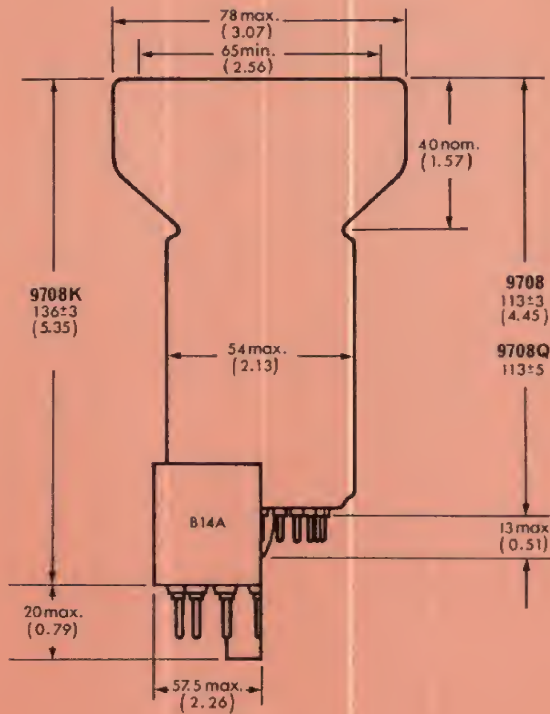
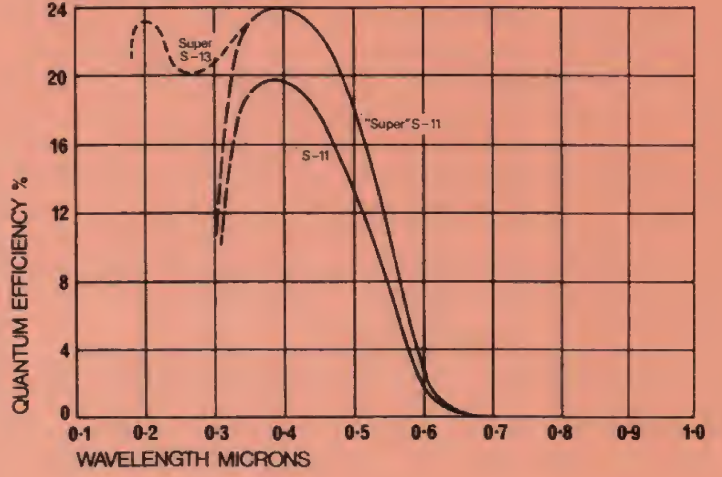

All dimensions are in millimetres with inches shown in parentheses.

75 mm tubes "bialkali" cathodes 130mm tubes "bialkali" and "trialkali" cathodes

The 9758B is a new 75 mm (3 in.) nominal diameter tube with a bialkali (SbKCs) cathode having a peak quantum efficiency between 20 and 30% at 3800Å. The dynode system comprises 9 venetian blind stages with highly stable and efficient CsSb secondary emitting surfaces.

A 130 mm (5 in.) version of the 9758B, namely type 9791B, is also available. Both types can be supplied with the standard EMI B19A base, or overcapped with a special B14A base as types 9758KB and 9791KB.

The high quantum efficiency and gain and low dark current of these types make them particularly suitable for low level scintillation counting and gamma or X-ray spectrometry.

The 9790B is also new to the EMI range and is a 130 mm (5 in.) nominal diameter tube with 9 venetian blind dynodes having CsSb secondary emitting surfaces. The cathode is of the S-20 (trialkali) type giving very high quantum efficiency in the blue as well as extremely good response in the red and near infra-red. This type is also available overcapped as type 9790KB.



Notes

- 1 a) Each tube is individually calibrated, and the test ticket furnished with the tube specifies the cathode sensitivity in $\mu\text{A}/\text{lm}$, the overall voltage at 200 A/lm and the dark current at that overall sensitivity at 20°C. In addition, a measurement of cathode blue sensitivity referred to the usual source with a Corning CS-5-58 filter (polished to half stock thickness) interposed is given for types 9758B and 9791B. The quantum efficiency at 4200Å can be calculated from the sensitivity with the Corning blue filter by multiplying by 2.50.
- b) Test data is obtained with cathode - D1 volts held at 300V (9758B) or 450V (9791B, 9790B) and a "Standard" dynode chain.*
- c) In general, when setting up experiments or designing for equipment, it is desirable to work at, or below, the ticket voltage of the individual tube.
- d) For highest stability in d.c. conditions, mean anode current should not exceed 10 μA .
- 2 Any material in contact with the glass envelope must be held at cathode potential. Failure to do so may result in erratic operation and high dark current.
- 3 Take great care in clamping tubes. Excess pressure may fracture the glass in which case the warranty is void.
- 4 Photomultipliers are affected by magnetic fields and mu-metal shields should be used, (see page 64).

* For recommended dynode chains refer to Groups D, E, F on page 14.

MECHANICAL CHARACTERISTICS

	9758	9791 9790
Max. bulb dia.	78 mm (3.07 in)	130 mm (5.12 in)
Max. neck dia.	54 mm (2.13 in)	54 mm (2.13 in)
Min. cathode dia.	65 mm (2.56 in)	111 mm (4.37 in)
Cathode type	Bialkali	9791 Bialkali 9790 Trialkali (S-20)
Window material	Borosilicate	Borosilicate
Dynodes	9VB (All CsSb secondary emitting surfaces)	9VB
Base	B19A	B19A

Low loss pressed glass base furnished with appropriate high quality Teflon socket. Tubes with "K" suffix overcapped with diheptal base type B14A; socket not supplied

ELECTRICAL RATINGS

	9758	9791	9790
Cathode to D1	350V Max.	500V Max.	500V Max.
Recommended cathode to D1 voltage	300V	450V	450V
Cathode to anode (subject to not exceeding)	2100V Max. 200A/lm	2250V Max. 200A/lm	2250V Max. 200A/lm
Overall sensitivity: Rated Max.	50A/lm 200A/lm	50A/lm 200A/lm	50A/lm 200A/lm
Max. anode current (mean)	1 mA (all types)		
Max. anode dissipation	1W (all types)		
Max. tolerable cathode current	0.5 μA	1.0 μA	30 μA
Max. operating temp.	60°C	60°C	60°C
Min. operating temp.	-5°C	-5°C	-180°C
Anode pulse rise time	12 ns	20 ns	20 ns
Anode pulse f.w.h.m.	50 ns	70 ns	70 ns
Transit time	70 ns	110 ns	110 ns
Capacitance, anode to all dynodes	8 pF (all types)		
Dark current shot noise Typical (λ peak) lumens:	4.3×10^{-13}	6.8×10^{-13}	5.0×10^{-13}
watts:	3.6×10^{-16}	5.7×10^{-16}	9.5×10^{-16}

	Cathode Sensitivity with Corning Blue filter interposed		Cathode Sensitivity $\mu\text{A}/\text{lm}$	
	Min.	Typ.	Min.	Typ.
9758B	7.0	9.5	—	70
9791B	7.0	9.5	—	70
9790B	—	—	100	130

	Overall Sensitivity 50A/lm				Overall Sensitivity 200A/lm			
	V Overall Typ.	V Overall Max.	Dark Current nA Typ.	Dark Current nA Max.	V Overall Typ.	V Overall Max.	Dark Current nA Typ.	Dark Current nA Max.
9758B	1300	1750	2	50	1550	—	8	—
9791B	1350	1850	5	125	1650	—	20	—
9790B	1350	1850	5	125	1650	—	20	—

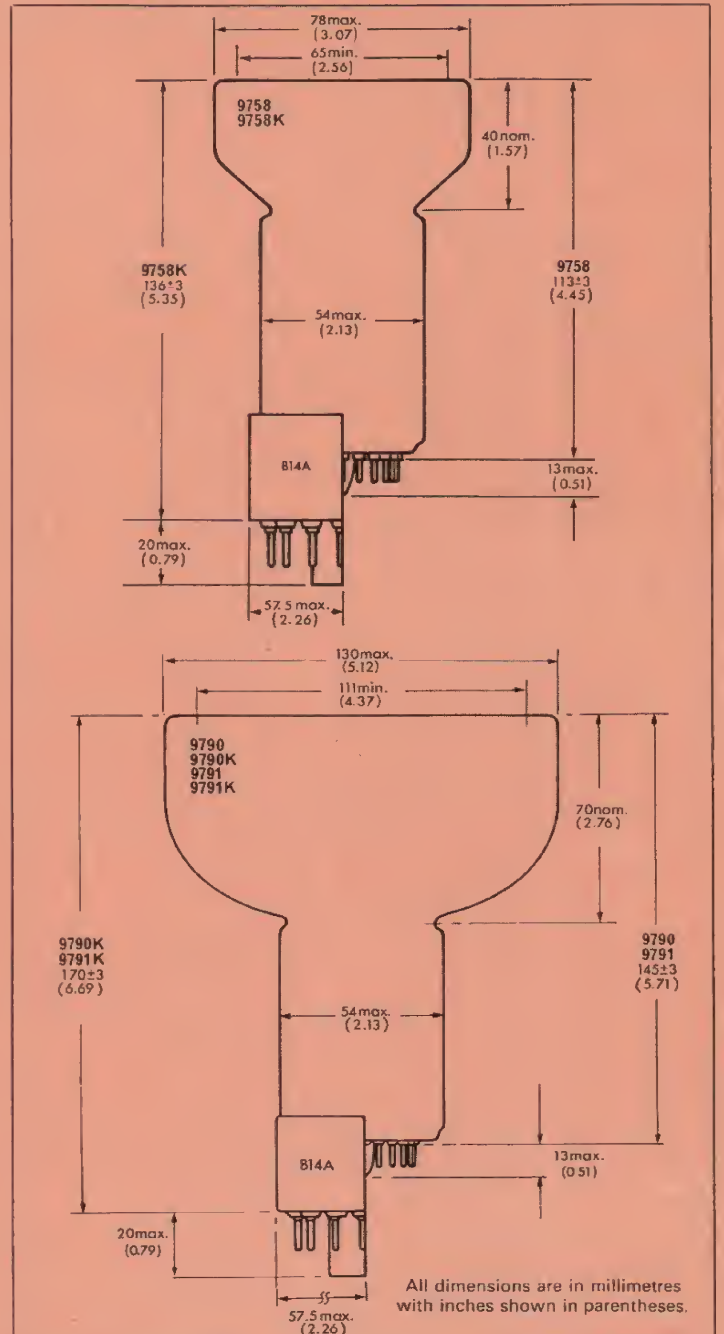
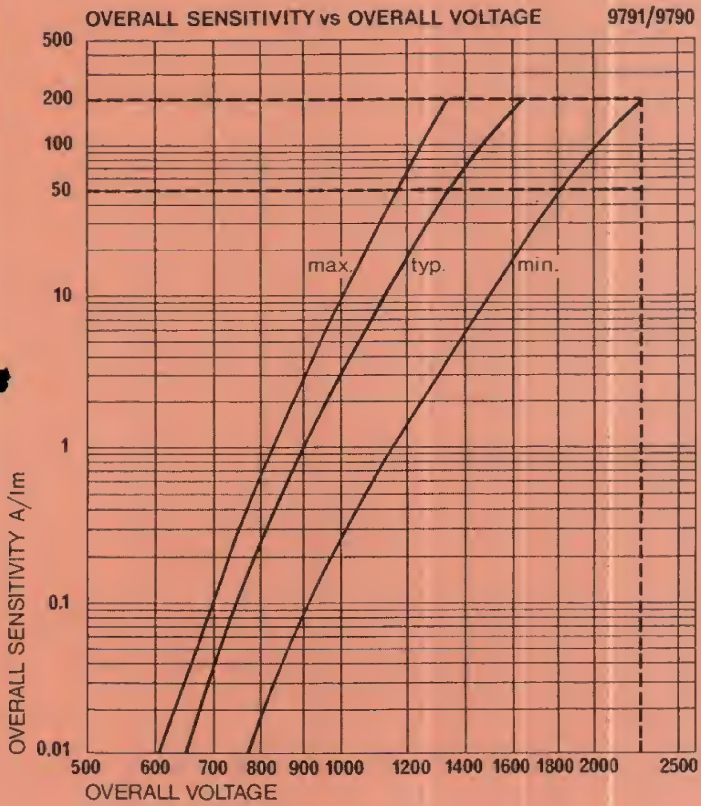
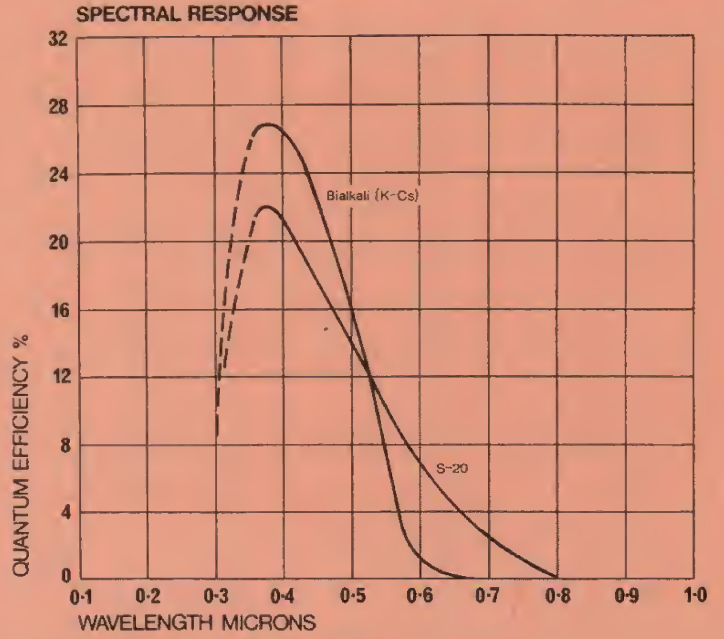
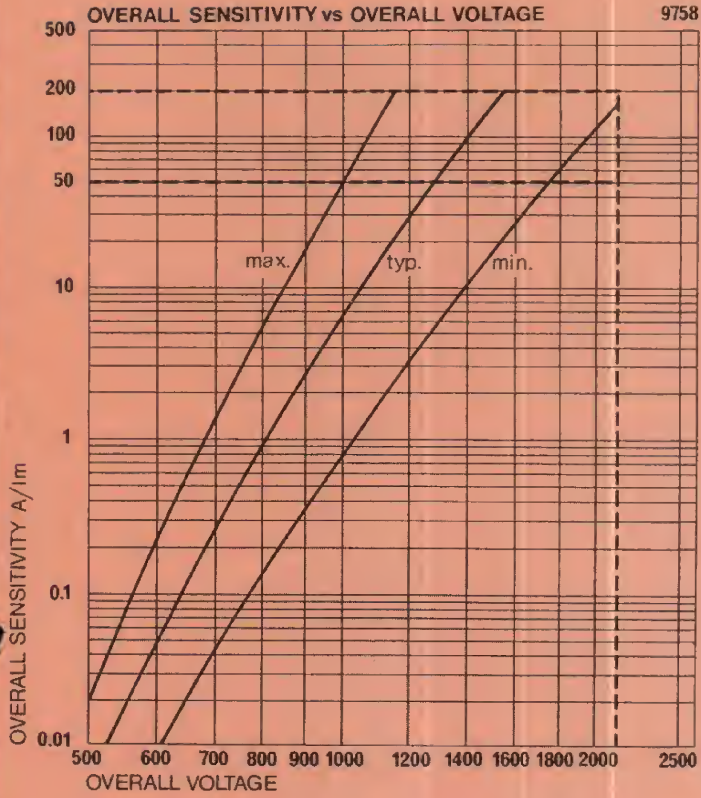

PIN CONNECTIONS (Viewed from below starting left of Short Pin or Key)

Type	1	2	3	4	5	6	7	8	9	10	11	12	13	14	15	16	17	18	19	Socket
9758	IC	D1	D2	D3	D4	D5	D6	D7	D8	IC	D9	A	IC	IC	IC	IC	IC	IC	K	B19A
9758K	D1	D2	D3	D4	D5	D6	D7	D8	IC	D9	A	IC	IC	K						B14A
9791	IC	D1	D2	D3	D4	D5	D6	D7	D8	IC	D9	A	IC	IC	IC	IC	IC	IC	K	B19A
9791K	D1	D2	D3	D4	D5	D6	D7	D8	IC	D9	A	IC	IC	K						B14A
9790	IC	D1	D2	D3	D4	D5	D6	D7	D8	IC	D9	A	IC	IC	IC	IC	IC	IC	K	B19A
9790K	D1	D2	D3	D4	D5	D6	D7	D8	IC	D9	A	IC	IC	K						B14A

All dimensions are in millimetres with inches shown in parentheses.

90 and 100mm tubes S-11, S-13, Super S-11, Super S-13 cathodes

The EMI type 9531 is a unique design in which the front end geometry has been carefully optimised in order to give the best resolution with 75 mm scintillation crystals. It should be noted, for the benefit of present users, that the focus element has been eliminated, resulting in a marked improvement in resolution. Standard 75 mm photomultipliers have cathode diameters of only 65 mm, whereas the 9531 has very closely a 75 mm diameter cathode making a very good match with 75 mm scintillators. The 9531 series have 11 CsSb venetian blind dynodes.

The 9531R is supplied with a "Super" S-11 cathode which has a typical peak quantum efficiency of 24% at 4000Å. In addition the measured parameters are much more tightly grouped when compared with samples of standard grade tubes. Every 9531R is tested with our standard factory NaI-Tl crystal and must give a minimum peak to valley ratio for Co⁶⁰ of 7:1. This corresponds to a resolution for Cs¹³⁷ of ca. 7.8%.

For less stringent applications, the 9531B, which has an S-11 cathode, can be supplied at lower cost.

For those applications requiring an extension of the spectral response into the UV, or in those where radioactivity in the window or bulb might be objectionable, tubes can be supplied with quartz bulbs to special order, e.g. 9531QB.

Type 9711NB is electrically similar to the standard type, but is designed to be rugged enough to withstand environmental conditions encountered in rockets, satellites, etc. (see page 59).

A 100 mm variant of the 9531, having 9 CsSb dynodes, is type 9732, and is available in grades "R" and "B".

Notes

- Each tube is individually calibrated and the test ticket furnished with the tube specifies the cathode sensitivity in $\mu\text{A}/\text{lm}$, the overall voltage at 200 A/lm (9531) or 50 A/lm (9732) and the dark current at that overall sensitivity at 20°C.
 - Test data is obtained with cathode - D1 voltage held at 300V and a "Standard" dynode chain*.
 - In general, when setting up experiments or designing for equipment, it is desirable to work at, or below, the ticket voltage of the individual tube.
 - For highest stability in d.c. conditions, mean anode current should not exceed 10 μA .
- Any material in contact with the glass envelope must be held at cathode potential. Failure to do so may result in erratic operation and high dark current.
- Take great care in clamping tubes, particularly those with quartz bulbs. Excess pressure may fracture the glass in which case the warranty is void.
- Photomultipliers are affected by magnetic fields and mu-metal shields should be used, (see page 64).

* For recommended dynode chains, refer to Groups H, I, J (9531) or Groups D, E, F (9732) on page 14.

MECHANICAL CHARACTERISTICS

	9531	9732
Max. bulb dia.	91 mm (3.58 in)	102 mm (4.02 in)
Max. neck dia.	54 mm (2.13 in)	54 mm (2.13 in)
Min. cathode dia.	77 mm (3.03 in)	92 mm (3.62 in)
Cathode type	9732R 9732B	9531R 9531B "Super" S-11 S-11
Window material	All types borosilicate. Quartz to special order except 9732 types	
Dynodes	11VB (All CsSb secondary emitting surfaces)	9VB
Base	B15B	B19A
	Low loss pressed glass base furnished with appropriate high quality Teflon socket	



ELECTRICAL RATINGS

	9531	9732		
Cathode to D1	350V Max.	350V Max.		
Recommended cathode to D1 voltage	300V	300V		
Cathode to anode (subject to not exceeding)	2350V Max. 2000A/lm	2100V Max. 200A/lm		
Overall sensitivity: Rated Max.	200A/lm 2000A/lm	50A/lm 200A/lm		
Max. anode current (mean)	1 mA	1 mA		
Max. anode dissipation	1 W	1 W		
Max. tolerable cathode current	1 μA	1 μA		
Max. operating temperature	60°C	60°C		
Min. operating temperature	-80°C	-80°C		
Anode pulse rise time	14 ns	12 ns		
Anode pulse f.w.h.m.	38 ns	30 ns		
Transit time	110 ns	85 ns		
Capacitance, anode to all dynodes	8 pF	8 pF		
Dark current shot noise Typical (λ peak)	9531R lumens: 2.7×10^{-13} watts: 3.9×10^{-16}	9531B 3.1×10^{-13} 4.2×10^{-16}	9732R 5.4×10^{-13} 7.8×10^{-16}	9732B 6.3×10^{-13} 8.5×10^{-16}

Cathode Sensitivity $\mu\text{A}/\text{lm}$ Min. Typ.	Overall Sensitivity 200A/lm				Overall Sensitivity 2000A/lm					
	V Overall Typ.	V Max.	Dark Current nA Typ.	Dark Current nA Max.	V Overall Typ.	V Max.	Dark Current nA Typ.	Dark Current nA Max.		
9531R	80	110	1250	1600	5	100	1650	—	50	—
9531B	50	80	1300	1900	5	250	1750	—	50	—
			50A/lm				200A/lm			
9732R	80	110	1250	1500	5	40	1550	—	20	—
9732B	50	80	1250	1750	5	100	1550	—	20	—

Resolution: 9531R and 9732R must give better than 7:1 and 5:1 respectively peak/valley ratio for Co⁶⁰ with standard factory crystal.

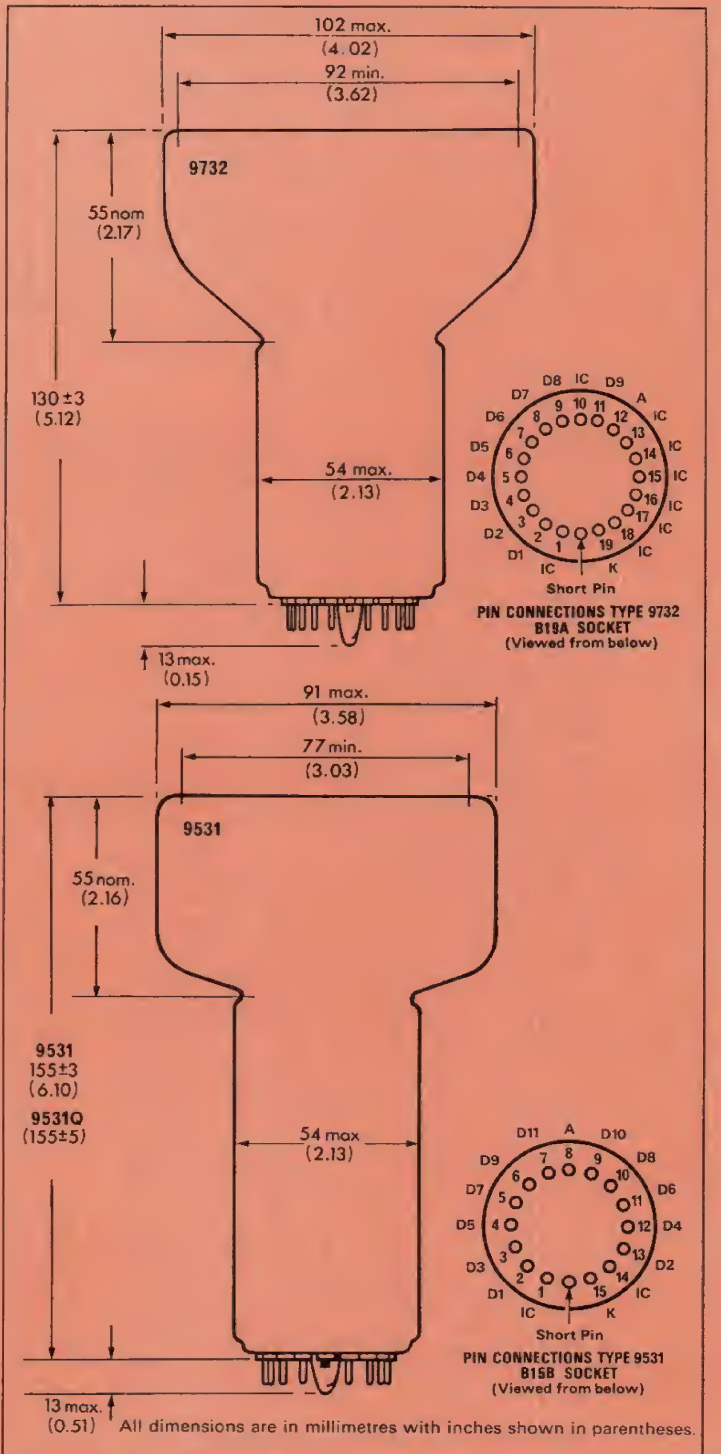
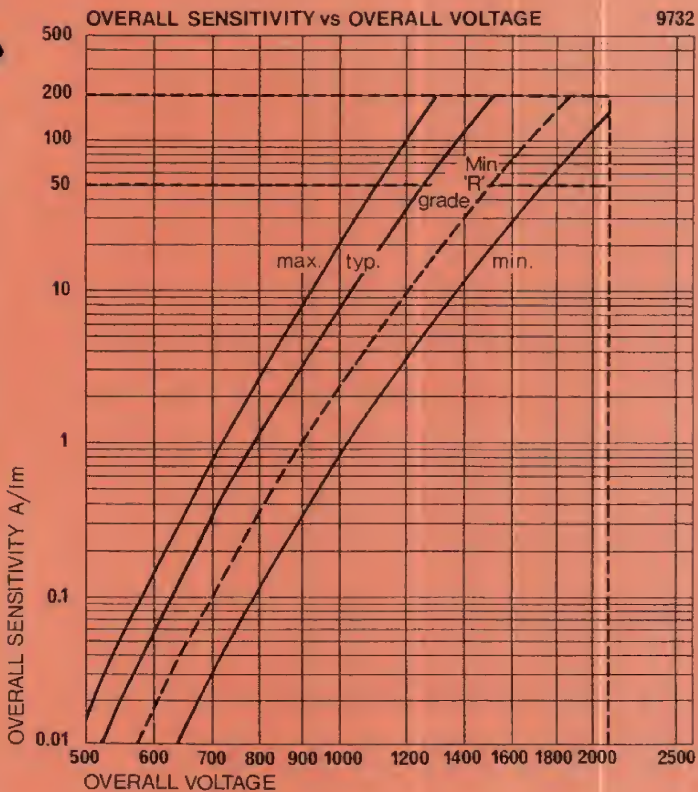
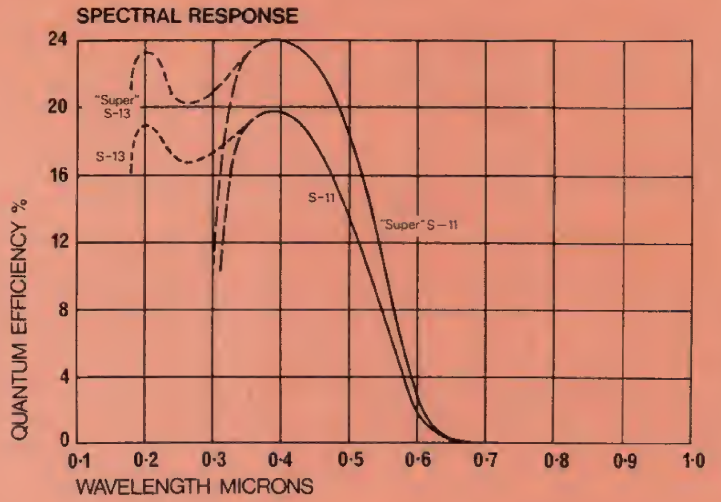
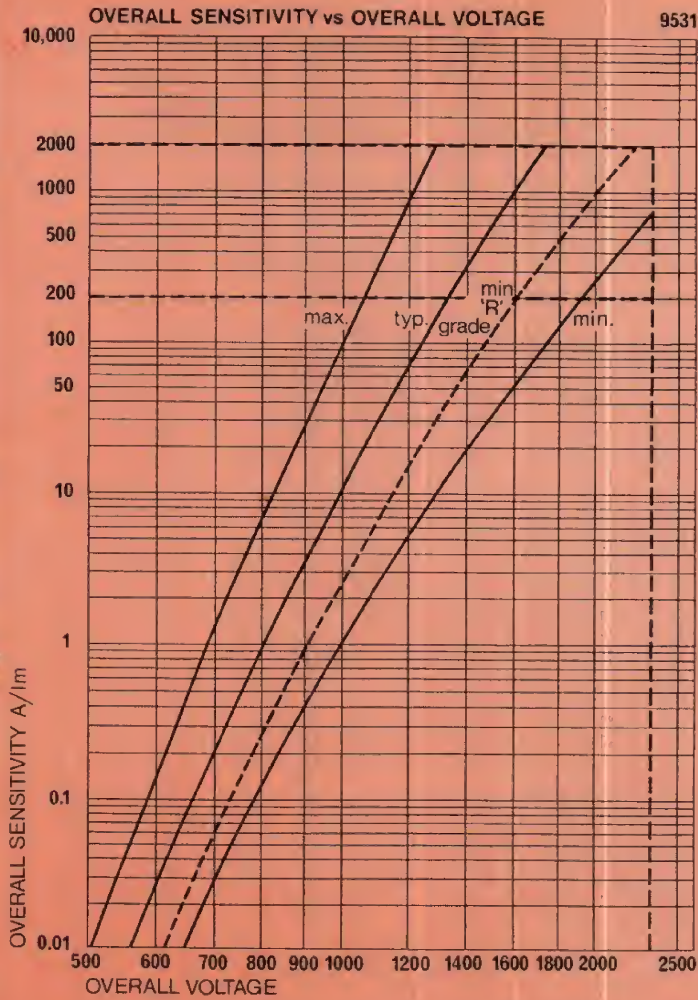

130mm tubes S-11, S-13, Super S-11, Super S-13, S-20 cathodes

The EMI series of 130mm (5in.) nominal diameter photomultipliers all employ venetian blind dynode systems having either 9 or 11 stages with CsSb secondary emitting surfaces.

The 9-stage type 9709KB is designed to be directly interchangeable with 10-stage tubes of other manufacturers. When plugged into sockets wired for other 10-stage tubes, the new recommended voltage distribution will automatically appear between the dynodes.

The 9709R and 9530R, which is the 11 dynode version, both utilize the "Super" S-11 cathode and are both tested for resolution with our standard factory NaI-Tl crystal. For applications of a less stringent nature, the 9709B, 9709KB or 9530B, 9530KB are available at lower cost.

The 9618 types are, in general, similar to the 9530 but incorporate a focus element and a separate external cathode connection. This results in a tube with faster time of response. The 9618R utilizes the "Super" S-11 cathode, and the 9618B the S-11. This type is also available with the S-20 cathode as type 9618TB.

For low level scintillation counting, or for an extension of the spectral response into the UV, types 9709 and 9530 are available with quartz bulbs, to special order only. It should also be noted that 9530 types can be supplied overcapped—e.g. 9530KB.

Tubes from this family find extensive application in gamma and X-ray spectrometry as well as in whole body monitors and health physics in general. The 9618 has also been used in the detection of fast neutrons and neutrinos.

Notes

- Each tube is individually calibrated and the test ticket furnished with the tube specifies the cathode sensitivity in $\mu\text{A}/\text{lm}$, the overall voltage at 50 A/lm and 200 A/lm for 9 and 11 dynode tubes respectively, and the dark current at that overall sensitivity at 20°C.
 - Test data is obtained with cathode -D1 voltage held at 450V and a "Standard" dynode chain.*
 - In general, when setting up experiments or designing for equipment, it is desirable to work at, or below, the ticket voltage of the individual tube.
 - For highest stability in d.c. conditions, mean anode current should not exceed 10 μA .
 - Type 9618 Focus: adjust for critical applications, but generally set to -100V to D1 with K-D1 at 450V.
- Any material in contact with the glass envelope must be held at cathode potential. Failure to do so may result in erratic operation and high dark current.
- Take great care in clamping tubes, particularly those with quartz bulbs. Excess pressure may fracture the glass in which case the warranty is void.
- Photomultipliers are affected by magnetic fields, and mu-metal shields should be used, (see page 64).

* For recommended dynode chains refer to Groups D, E, F for 9-stage tubes and Groups H, I, J for 11-stage tubes on page 14.



ELECTRICAL RATINGS

	9530	9709	9618
Cathode to D1	500V Max.	500V Max.	750V Max.
Recommended cathode to D1 voltage	450V	450V	450V
Cathode to anode (subject to not exceeding)	2500V Max. 2000A/lm	2250V Max. 200A/lm	2750V Max. 2000A/lm
Overall sensitivity: Rated	200A/lm	50A/lm	200A/lm
Max.	2000A/lm	200A/lm	2000A/lm
Max. anode current (mean)	1 mA (all types)		
Max. anode dissipation	1W (all types)		
Max. tolerable cathode current	2 μA (all types except 9618TB; ca. 30 μA)		
Max. operating temp.	60°C (all types)		
Min. operating temp.	-80°C (all types except 9618TB; ca. -180°C)		
Anode pulse rise time	15 ns	20 ns	15 ns
Anode pulse f.w.h.m.	40 ns	70 ns	30 ns
Transit time	120 ns	110 ns	60 ns
Capacitance, anode to all dynodes	8 pF (all types)		
Dark current shot noise Typical (λ peak)	9530R 9618R	9530B 9618B	9709R
lumens:	4.4×10^{-13}	4.9×10^{-13}	7.8×10^{-13}
watts:	5.8×10^{-16}	6.5×10^{-16}	1.1×10^{-15}

MECHANICAL CHARACTERISTICS

	9530	9709	9618
Max. bulb dia.	130 mm	130 mm	130 mm
Max. neck dia.	54 mm	54 mm	56 mm
Min. cathode dia.	111 mm	111 mm	111 mm
Cathode type	R grade: "Super" S-11 B grade: S-11 T grade: S-20		
Window material	All types Borosilicate. Quartz to special order except 9618 types		
Dynodes	11 VB	9VB	11 VB+ Focus
	(All CsSb secondary emitting surfaces)		
Base	B15B	B19A	B15B
	All have low loss pressed glass bases and are furnished with the appropriate Teflon socket. 9709KB and 9530KB are overcapped with diheptal base type B14A		

Cathode Sensitivity $\mu\text{A}/\text{lm}$	Min.	Typ.	Overall Sensitivity 200A/lm				Overall Sensitivity 2000A/lm			
			V Overall		Dark Current nA		V Overall		Dark Current nA	
			Typ.	Max.	Typ.	Max.	Typ.	Max.	Typ.	Max.
9530R	80	100	1300	1700	12	200	1650	—	120	—
9530B	50	80	1300	2000	12	500	1650	—	120	—
9618R	80	100	1300	1700	12	200	1650	—	120	—
9618B	50	80	1300	2000	12	500	1650	—	120	—
9618TB	100	130	1100	2000	20	100	1400	—	200	—
			50A/lm				200A/lm			
9709R	80	105	1350	1600	10	50	1650	—	40	—
9709B	50	80	1350	1850	10	125	1650	—	40	—

Resolution: 9530R and 9709R tested, 9618R—not applicable.

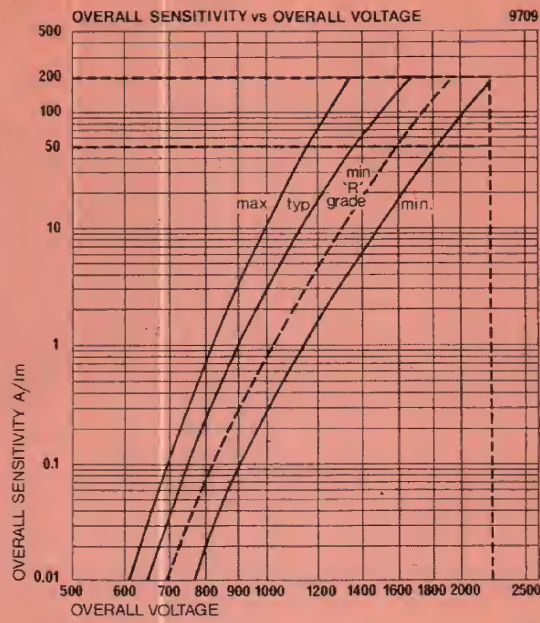
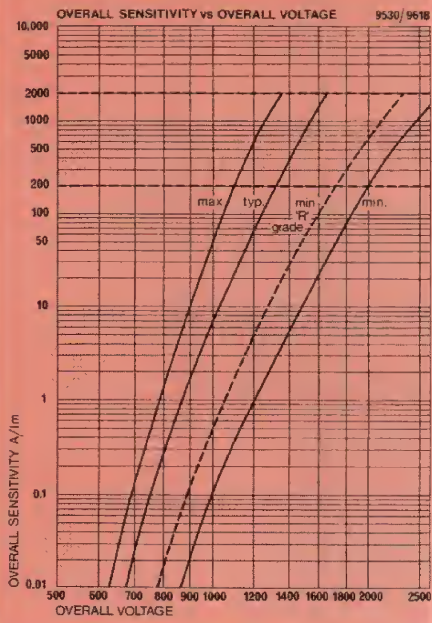

9709R 9618R 9530R
 9709B 9618B 9530B
 9709KB 9618TB

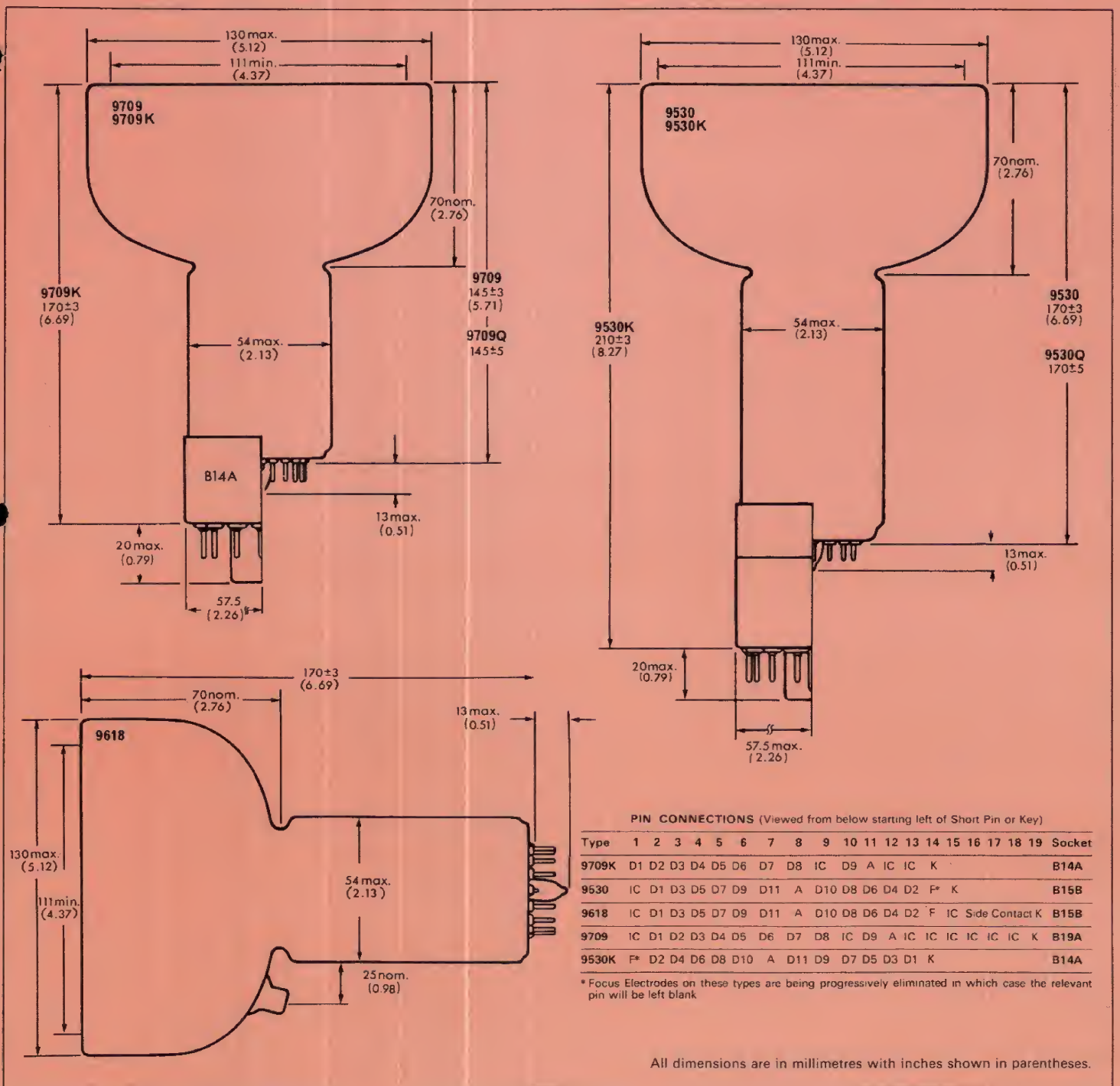
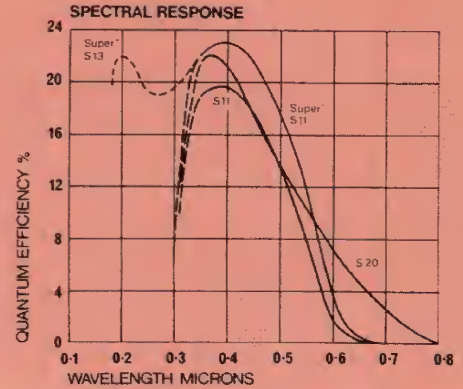

PIN CONNECTIONS (Viewed from below starting left of Short Pin or Key)

Type	1	2	3	4	5	6	7	8	9	10	11	12	13	14	15	16	17	18	19	Socket
9709K	D1	D2	D3	D4	D5	D6	D7	D8	IC	D9	A	IC	IC	K						B14A
9530	IC	D1	D3	D5	D7	D9	D11	A	D10	D8	D6	D4	D2	F*	K					B15B
9618	IC	D1	D3	D5	D7	D9	D11	A	D10	D8	D6	D4	D2	F	IC	Side Contact	K			B15B
9709	IC	D1	D2	D3	D4	D5	D6	D7	D8	IC	D9	A	IC	IC	IC	IC	IC	IC	K	B19A
9530K	F*	D2	D4	D6	D8	D10	A	D11	D9	D7	D5	D3	D1	K						B14A

* Focus Electrodes on these types are being progressively eliminated in which case the relevant pin will be left blank.

All dimensions are in millimetres with inches shown in parentheses.

190mm tubes S-11 cathodes

The 9623B is a 190 mm (7.5 in.) nominal diameter flat-faced photomultiplier, having a minimum cathode diameter of 172 mm (6.8 in.). The dynode system consists of 11 venetian blind stages with the highly efficient and stable CsSb secondary emitting surfaces developed by EMI. The photocathode is the S-11 (CsSbO) type giving a typical peak quantum efficiency of 17% at 4000Å.

In order to ensure maximum efficiency and uniformity of collection of photoelectrons into D1, two focus elements are provided. F1 is one contact on the bulb (the other being cathode) and F2 is at pin 14 on the base.

The 9623 finds its principal use with large scintillation crystals, large area plastic phosphors and, when used in banks, with large volumes of liquid scintillators, as in whole body monitors.



Notes

- 1 a) Each tube is individually calibrated and the test ticket furnished with the tube specifies the cathode sensitivity in $\mu\text{A}/\text{lm}$, the overall voltage at 200 A/lm and the dark current at that overall sensitivity at 20°C.
b) Test data is obtained with cathode -D1 voltage held at 750V and a "Standard" dynode chain.
c) In general, when setting up experiments or designing for equipment, it is desirable to work at, or below, the ticket voltage of the individual tube.
d) For highest stability in d.c. conditions, mean anode current should not exceed 10 μA .
- 2 Any material in contact with the glass envelope must be held at cathode potential. Failure to do so may result in erratic operation and high dark current.
- 3 Take great care in clamping tubes. Excess pressure may fracture the glass in which case the warranty is void.
- 4 Photomultipliers are affected by magnetic fields and mu-metal shields should be used, (see page 64).

Focus: with cathode -D1 at 750V, set F1-D1 to ca. 600V, F2-D1 to ca. 50V. For critical applications adjust F1 and F2 to optimise performance.

MECHANICAL CHARACTERISTICS

Max. bulb dia.	190 mm (7.5 in)
Max. neck dia.	56 mm (2.2 in)
Min. cathode dia.	172 mm (6.8 in)
Cathode type	S-11
Window material	Borosilicate
Dynodes	11 venetian blind with CsSb secondary emitting surfaces
Base	Low loss 15-pin pressed glass base furnished with high quality Teflon socket type B15B

ELECTRICAL RATINGS

Cathode to D1	1000V Max.
Recommended cathode to D1 voltage	750V
Cathode to anode (subject to not exceeding)	3000V Max. 2000A/lm)
Overall sensitivity: Rated Max.	200A/lm 2000A/lm
Max. anode current (mean)	1 mA
Max. anode dissipation	1W
Max. tolerable cathode current	3 μA
Max. operating temperature	60°C
Min. operating temperature	-80°C
Anode pulse rise time	12 ns
Anode pulse f.w.h.m.	60 ns
Transit time	90 ns
Capacitance, anode to all dynodes	8 pF
Dark current shot noise Typical (λ peak)	lumens: 1.7×10^{-12} watts: 2.3×10^{-15}

Cathode Sensitivity $\mu\text{A}/\text{lm}$ Min. Typ.	Overall Sensitivity 200A/lm		Overall Sensitivity 2000A/lm	
	V Overall Typ.	Dark Current nA Typ. Max.	V Overall Typ.	Dark Current nA Typ. Max.
9623B 50 80	1700	2100	150	1000
	2100	—	1500	—

OVERALL SENSITIVITY vs OVERALL VOLTAGE

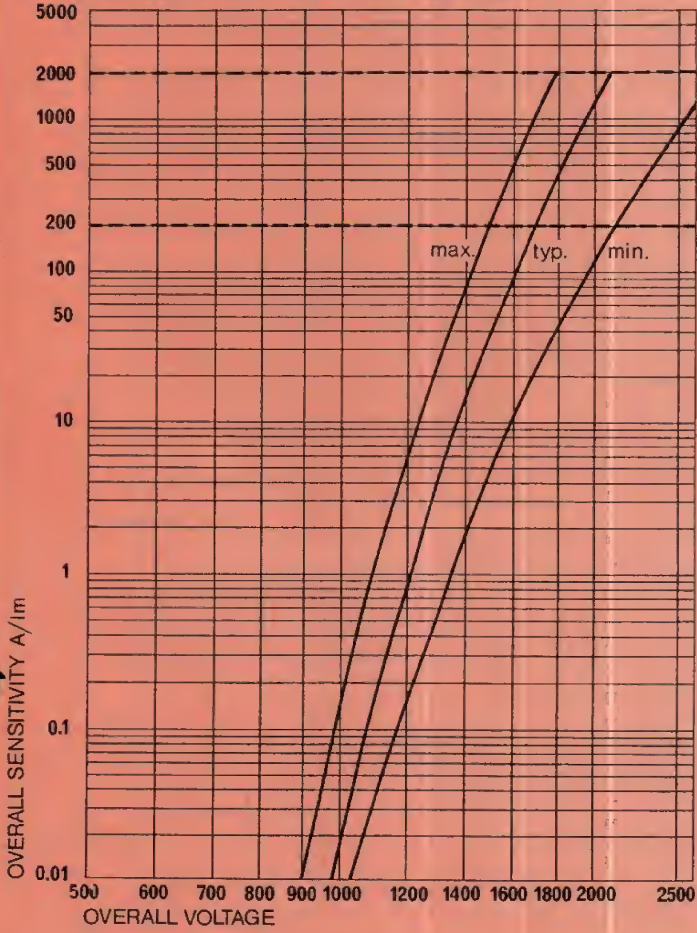

SPECTRAL RESPONSE

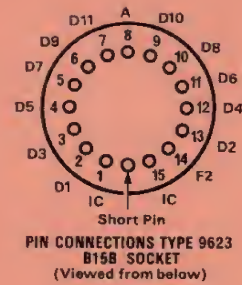
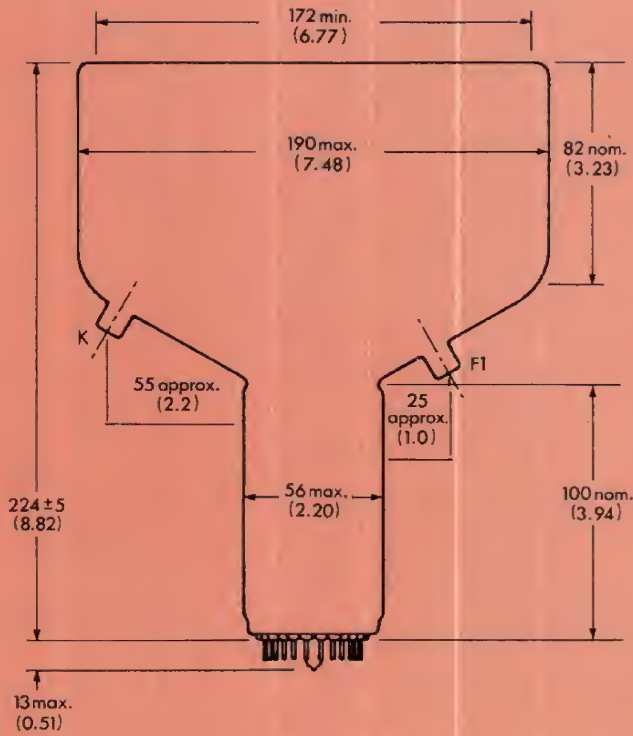
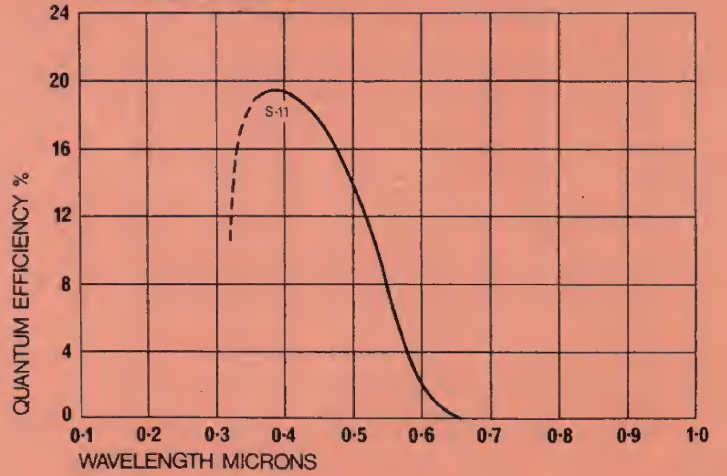

All dimensions are in millimetres with inches shown in parentheses.

310mm tubes S-11 cathodes

The EMI type 9545B is a 310 mm (12 in.) nominal diameter photomultiplier having a minimum cathode diameter of 250 mm (9.8 in.). The cathode is the standard S-11 (CsSbO) type having a typical peak quantum efficiency of 17% at 4000Å. It is fitted with 11 venetian blind dynodes using the highly efficient and stable CsSb secondary emitting surfaces developed by EMI. Optimum collection of photoelectrons from the cathode into the large area first dynode is accomplished by the adjustment of the potential applied to a focusing electrode.

This efficient collection coupled with high photosensitivity and D1 gain, render this type particularly suitable for many scintillation counting applications. It has been used with large NaI-Tl crystals (up to 11.5 in.), plastic phosphors, and in banks for observing large tanks of liquid scintillators such as in whole body monitors.

Since stray magnetic fields affect the operation of photomultiplier tubes, it is particularly important, with a tube of this size, to use a mu-metal shield.



Notes

- 1 a) Each tube is individually calibrated and the test ticket furnished with the tube specifies the cathode sensitivity in $\mu\text{A}/\text{lm}$, the overall voltage at 200 A/lm and the dark current at that overall sensitivity at 20°C.
- b) Test data is obtained with cathode -D1 volts held at 750V and a "Standard" dynode chain.*
- c) In general, when setting up experiments or designing for equipment, it is desirable to work at, or below, the ticket voltage of the individual tube.
- d) For highest stability in d.c. conditions, mean anode current should not exceed 10 μA .
- 2 Any material in contact with the glass envelope must be held at cathode potential. Failure to do so may result in erratic operation and high dark current.
- 3 Take great care in clamping tubes. Excess pressure may fracture the glass in which case the warranty is void.
- 4 Photomultipliers are affected by magnetic fields and mu-metal shields should be used, (see page 64).

* For recommended dynode chains refer to Groups H, I, J on page 14.

MECHANICAL CHARACTERISTICS

Max. envelope dia.	310 mm (12.2 in)
Min. cathode dia.	250 mm (9.8 in)
Cathode type	S-11
Window material	Borosilicate
Dynodes	11 venetian blind with CsSb secondary emitting surfaces
Base	Low loss 15-pin pressed glass base furnished with high quality Teflon socket type B15B

ELECTRICAL RATINGS

Cathode to D1	1000V Max.
Recommended cathode to D1 voltage	750V
Cathode to anode (subject to not exceeding)	3000V Max. 2000A/lm
Overall sensitivity: Rated Max.	200A/lm 2000A/lm
Max. anode current (mean)	1 mA
Max. anode dissipation	1 W
Max. tolerable cathode current	5 μA
Max. operating temperature	60°C
Min. operating temperature	-80°C
Anode pulse rise time	300 ns
Anode pulse f.w.h.m.	500 ns
Transit time	400 ns
Capacitance, anode to all dynodes	8 pF
Dark current shot noise Typical (λ peak)	lumens: 3.4×10^{-12} watts: 4.0×10^{-15}

Cathode Sensitivity $\mu\text{A}/\text{lm}$ Min. Typ.	Overall Sensitivity 200A/lm		Overall Sensitivity 2000A/lm	
	V Overall Typ. Max.	Dark Current nA Typ. Max.	V Overall Typ. Max.	Dark Current nA Typ. Max.
9545B 40 70	1750 2200	500 4000	2200 —	5000 —

OVERALL SENSITIVITY vs OVERALL VOLTAGE

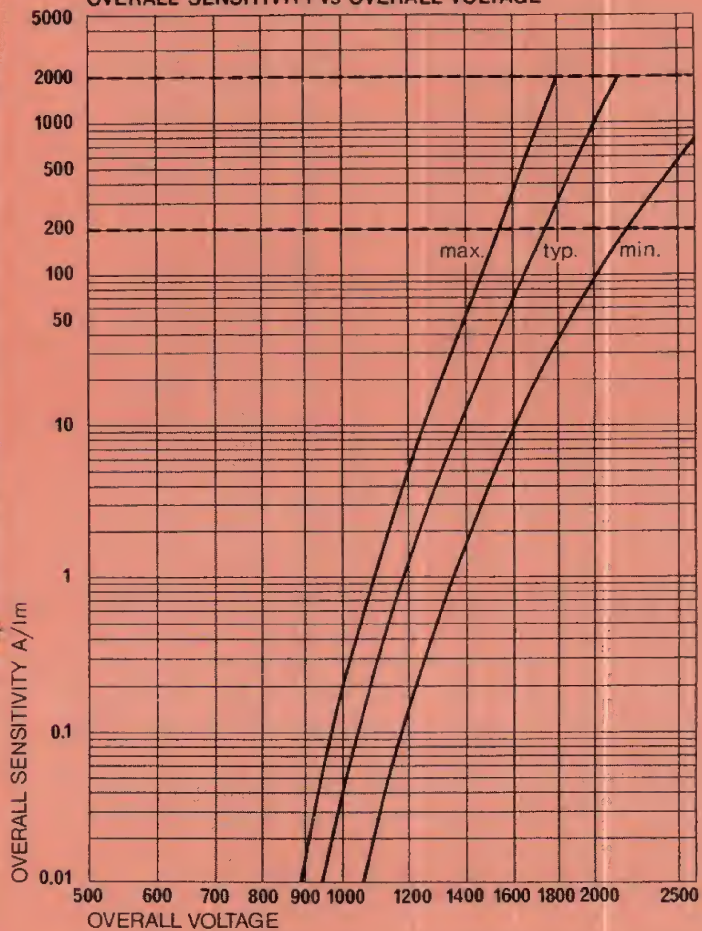

SPECTRAL RESPONSE

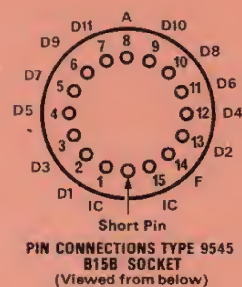
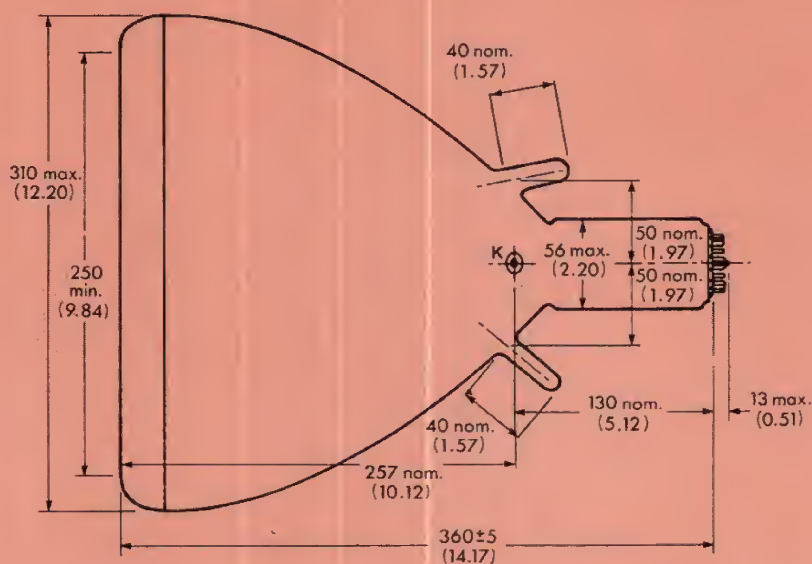
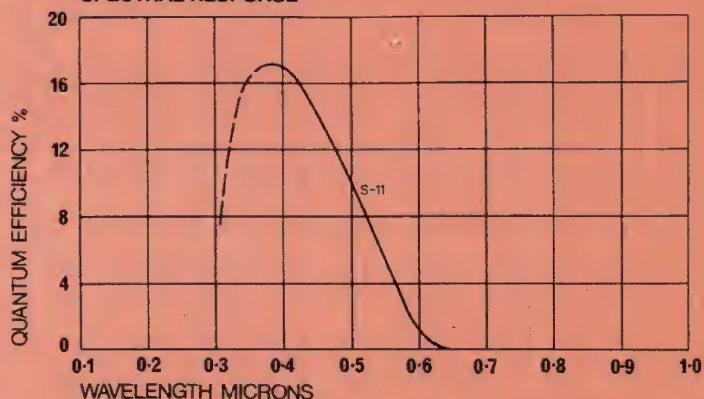

All dimensions are in millimetres with inches shown in parentheses.

Fast linear focused tubes

The 9594B is a high gain, high output current photomultiplier tube specially designed to give a very fast time of response. The typical anode pulse rise time and f.w.h.m., measured with a pulsed light source illuminating the complete cathode area, are 2ns and 3ns respectively. It is particularly suited for scintillation counter applications involving short resolving times. The CsSb dynode coating gives rather higher gain as well as very low gain shift with changing count rate when compared with other types of surfaces.

The 9594B is fitted with a Jedec B20-102 base, but is also available with a B19A base as type 9594UB. Either is available with a quartz window as type 9594QB or 9594QUB respectively.

A fast linear focused structure of 14 dynodes coated with CsSb secondary emitting material provides a gain in excess of 10^8 with an output current, under suitable pulsed conditions, linear to above 300mA when operated with the appropriate voltage distribution along the dynodes. A curved cathode of semitransparent S-11 type is deposited on a window which is flat externally to facilitate coupling to scintillating crystals. A system of focusing electrodes providing spherical equipotentials gives a small spread in transit time for photoelectrons from various parts of the cathode into D1.

The 9594B is also available with an S-20 cathode as type 9597B. Types 9595B and 9596B are 10-stage versions having S-11 and S-20 cathodes respectively. All types are available with quartz windows and can be supplied uncapped with a B19A base. The relevant suffix designations would be as for the variants of the 9594 described above.

Notes

- 1 a) Each tube is individually calibrated and the test data furnished with the tube gives the anode pulse rise time and anode pulse f.w.h.m. measured using a pulsed gallium phosphide light source illuminating the complete cathode area. The usual figures for cathode sensitivity and the dark current (at 20°C) and voltage corresponding to 5000 A/lm (9594, 9597) or 50 A/lm (9595, 9596) are also entered.
- b) Test data is obtained with cathode -D1 voltage held at 300V and the non-linear dynode chain shown herein.
- c) The deflector -D1 voltage and the focus -D1 voltage should be adjusted for optimum electron collection from cathode and maximum gain. It should be noted that due to design improvements the deflector electrode is being progressively eliminated.
- d) In general, when setting up experiments or designing for equipment, it is desirable to work at, or below, the ticket voltage of the individual tube.
- e) For highest stability in d.c. conditions, mean anode current should not exceed 10 μ A.
- 2 In order to obtain a high value of peak output current with good linearity between input light level and anode current, it is necessary to provide high voltages between the later stages of the photomultiplier tube.
- 3 Any material in contact with the glass envelope must be held at cathode potential. Failure to do so may result in erratic operation and high dark current.
- 4 Take great care in clamping tubes, particularly those with Spectrosil (fused silica) windows. Excess pressure may fracture the glass in which case the warranty is void.

MECHANICAL CHARACTERISTICS

	9594B 9594UB	9595B 9595UB	9596B 9596UB	9597B 9597UB
Max. envelope dia.	"B" versions: 52 mm (2.05 in) "UB" versions: 51.5 mm (2.02 in)			
Min. cathode dia.	41 mm	41 mm	41 mm	41 mm
Cathode type	S-11	S-11	S-20	S-20
Window material	"B" and "UB" versions: Borosilicate (flat externally, spherical internally) "QB" and "QUB" versions: Spectrosil (flat externally, spherical internally)			
Dynodes	14 LF (All linear focused (LF) with CsSb secondary emitting surfaces)	10 LF	10 LF	14 LF
Base	"B" versions: Jedec B20-102 (Socket not supplied) "UB" versions: B19A (Socket supplied)			



ELECTRICAL RATINGS

	9594 9597	9595 9596
Cathode to D1	400V Max.	400V Max.
Recommended cathode to D1 voltage	300V	300V
Anode to last dynode	800V Max.	800V Max.
Between dynodes	550V Max.	550V Max.
Overall sensitivity: Rated Max.	5000A/lm 10000A/lm	50A/lm 500A/lm
Max. anode current (mean)	1 mA	1 mA
Max. anode dissipation	0.5W	0.5W
Max. tolerable cathode current	S-11 types: 0.3 μ A S-20 types: 5 μ A	
Max. operating temperature	60°C	60°C
Min. operating temperature	-80°C	-80°C
Anode pulse rise time: Typical Max.	2 ns 3 ns	2 ns 3 ns
Anode pulse f.w.h.m.: Typical Max.	3 ns 5 ns	2.5 ns 5 ns
Transit time	50 ns	42 ns

Capacitance:
Anode to all electrodes "B" types: 6 pF "UB" types: 5 pF
Last dynode to all electrodes "B" types: 8 pF "UB" types: 7 pF

Dark current shot noise
Typical (λ peak)
lumens: 9594 4.9×10^{-13} 9595 1.3×10^{-12} 9596 9.6×10^{-13} 9597 3.7×10^{-13}
watts: 9594 6.5×10^{-16} 9595 1.7×10^{-15} 9596 2.0×10^{-15} 9597 7.7×10^{-16}

Cathode Sensitivity μ A/lm Min. Typ.	Overall Sensitivity 5000A/lm				Overall Sensitivity 10000A/lm					
	V Overall		Dark Current nA		V Overall		Dark Current nA			
	Typ.	Max.	Typ.	Max.	Typ.	Max.	Typ.	Max.		
*9594	50	80	2100	2650	300	3000	2300	—	6000	—
*9597	100	140	2300	2800	300	3000	2500	—	6000	—
†9594	50	80	2300	2850	300	3000	2500	—	6000	—
†9597	100	140	2500	3000	300	3000	2700	—	6000	—
			50A/lm				500A/lm			
*9595	50	80	1500	2150	20	50	2200	—	200	—
*9596	100	140	1700	2300	20	50	2500	—	200	—
†9595	50	80	1700	2350	20	50	2400	—	200	—
†9596	100	140	1900	2500	20	50	2700	—	200	—

*Linear dynode chain † Non-linear dynode chain

OVERALL SENSITIVITY vs OVERALL VOLTAGE 9594 (9597)

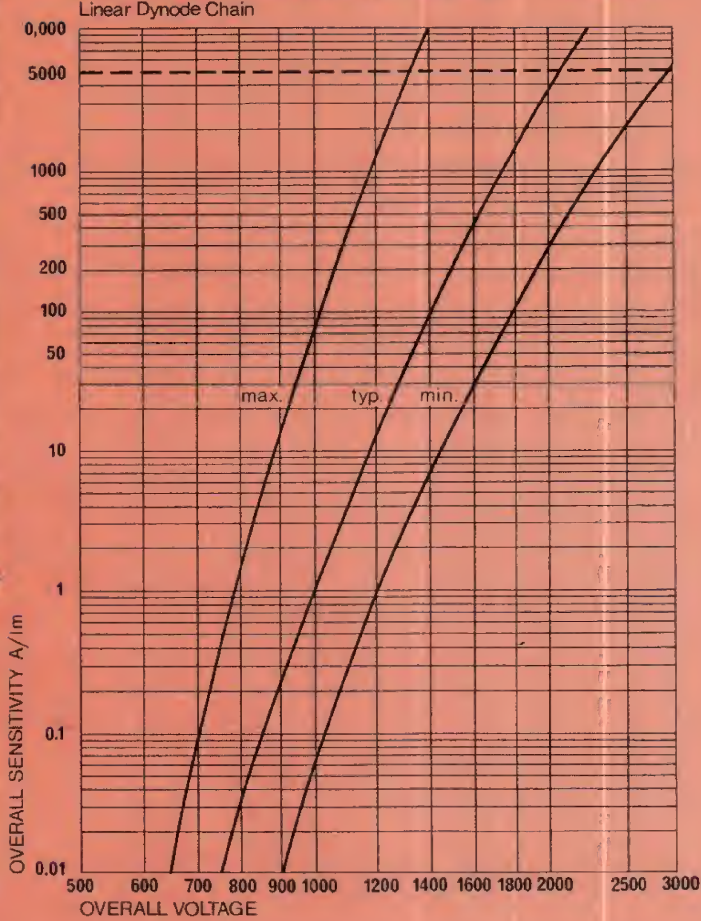

OVERALL SENSITIVITY vs OVERALL VOLTAGE 9594 (9597)

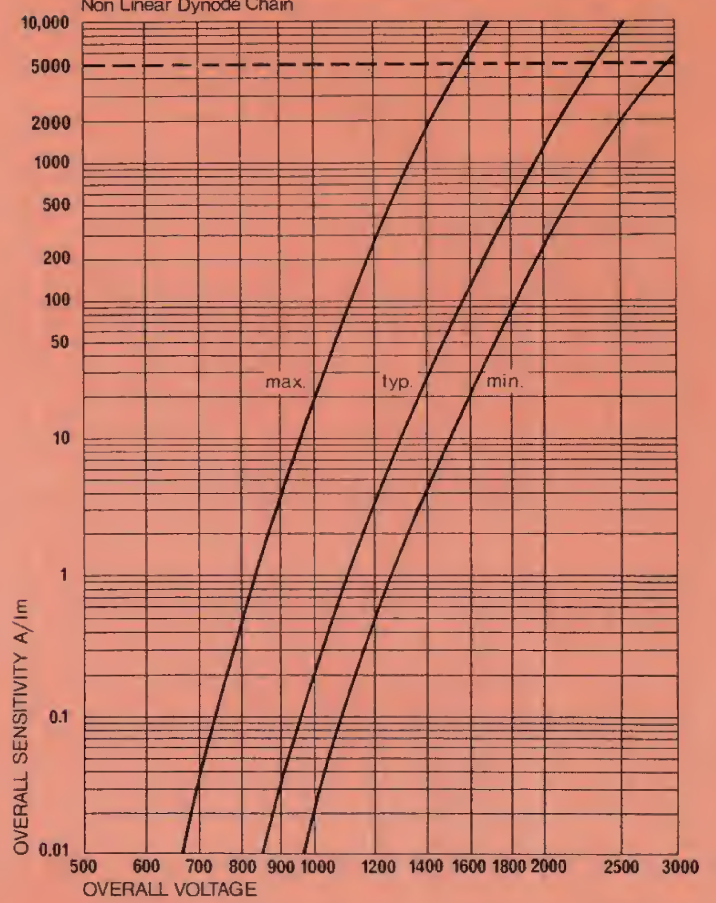

OVERALL SENSITIVITY vs OVERALL VOLTAGE 9595 (9596)

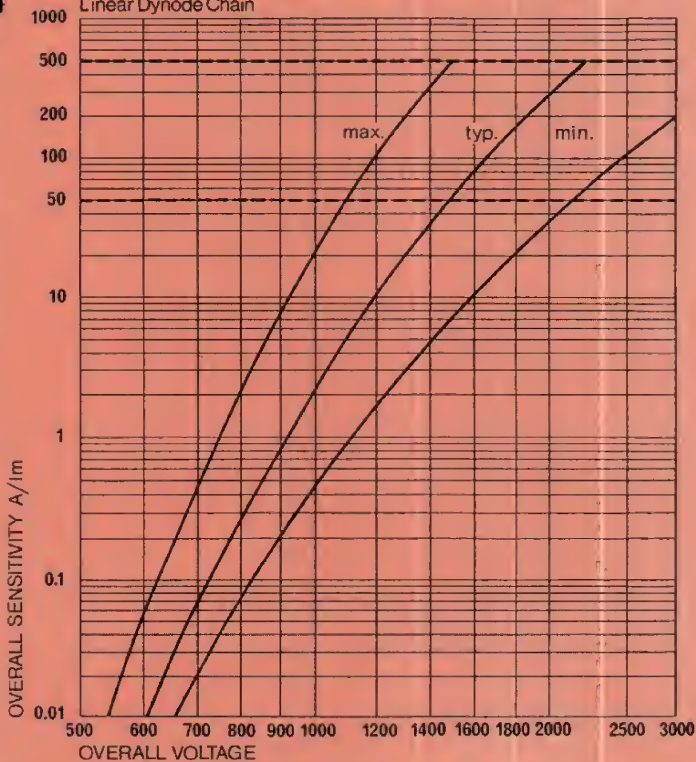

OVERALL SENSITIVITY vs OVERALL VOLTAGE 9595 (9596)

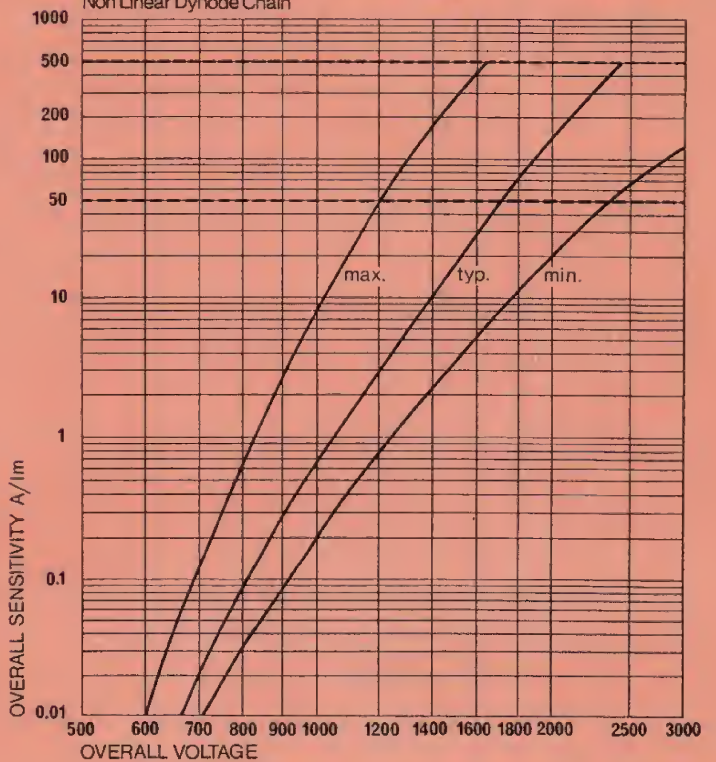

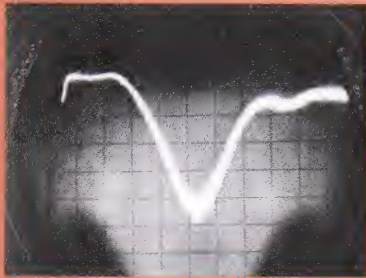
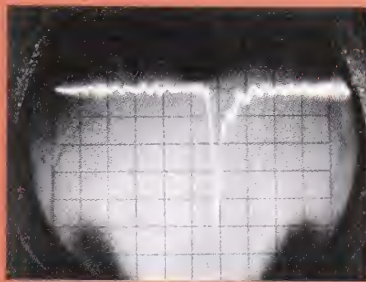

Photographs of the anode pulse of tube type 9594. The rise time is 1.8 n sec. and width at half maximum height 2.7 n sec. The base line ripple is due to pick up from the light flasher circuits.

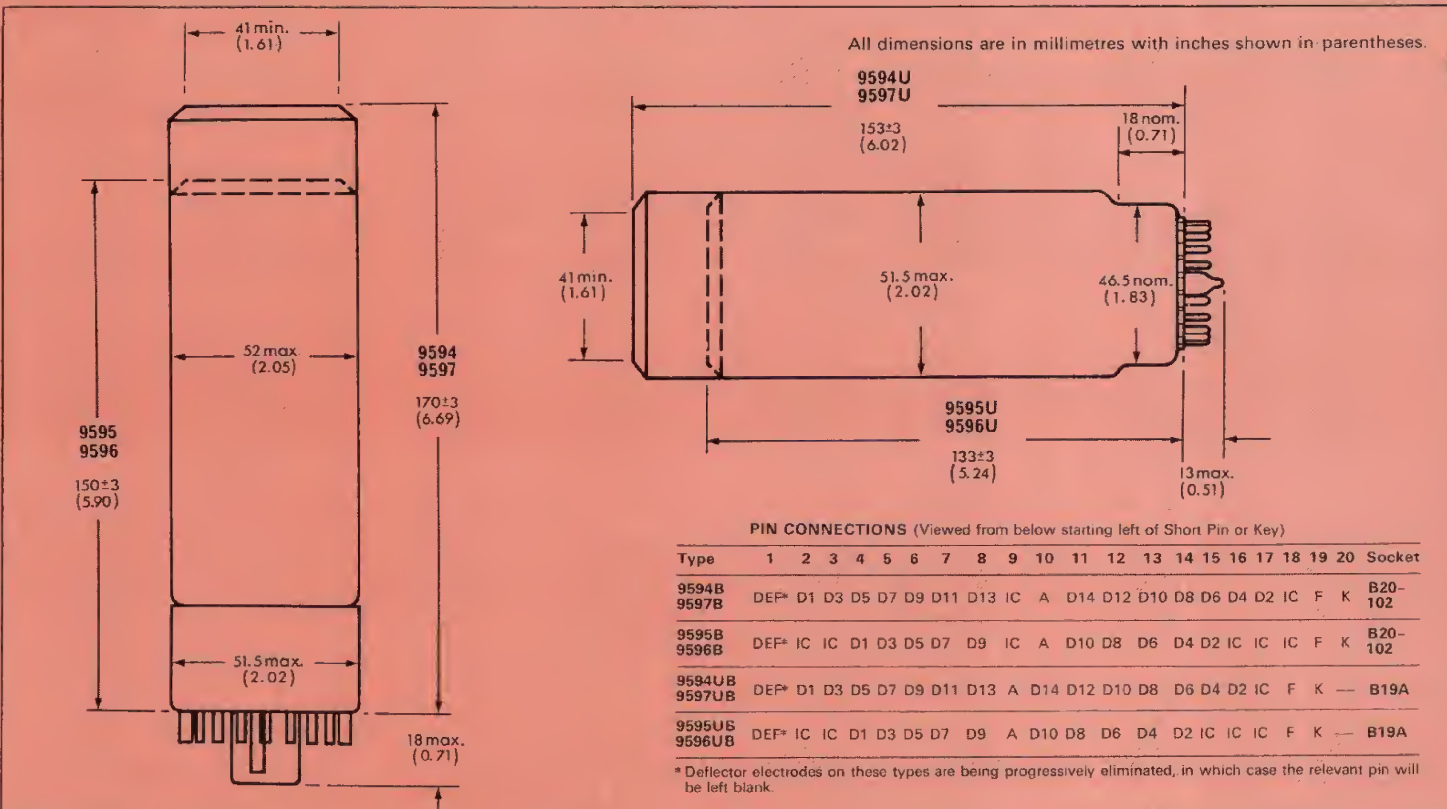
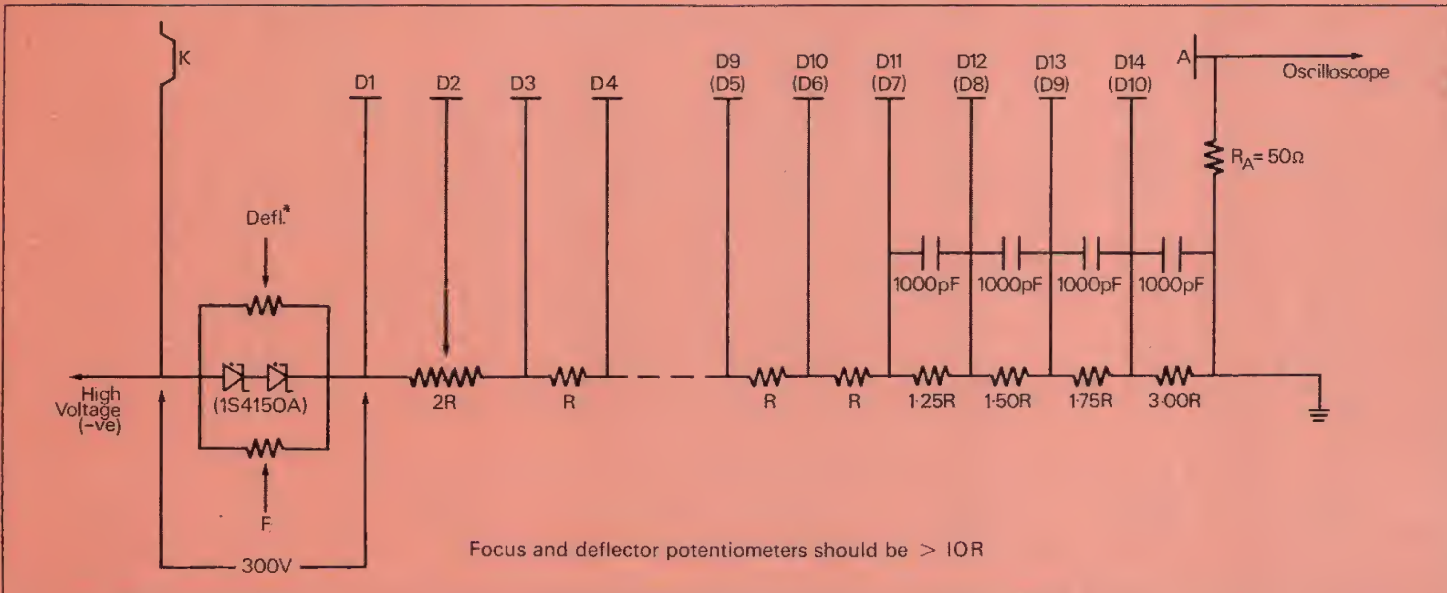
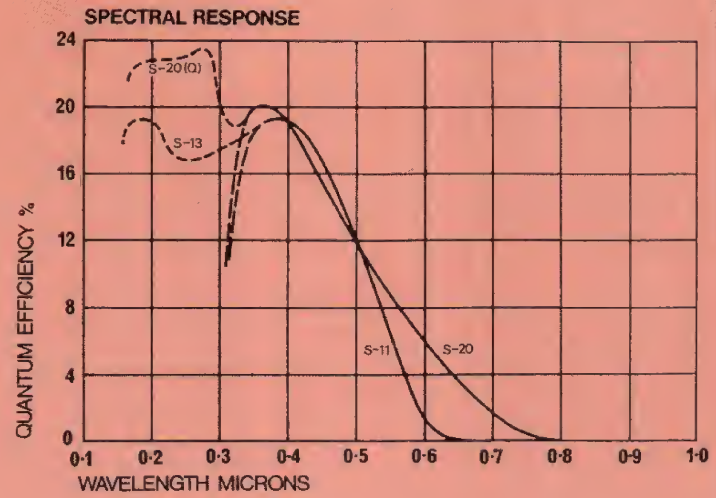

Rugged photomultiplier tubes

This series of EMI photomultipliers represent a selection of the most generally useful types which have been modified or redesigned to withstand the severe environmental conditions found in military or space applications. They represent a reasonable compromise between cost and mechanical performance without sacrifice of electrical quality. Properly mounted and encapsulated, they will be suitable for most applications of the type mentioned above. All EMI rugged photomultipliers are constructed almost entirely from non-ferromagnetic materials. The standard type from which each rugged design is derived is given below, the quartz versions being available to special order.

	Ruggedised	Standard	Quartz/ Spectrosil Ruggedised
30 mm nominal dia.	9734NB	9734B	9734QNB
50 mm nominal dia.	9647NB 9644NB	6097B 9514B	9647QNB 9644QNB
90 mm nominal dia.	9711NB	9531B	9711QNB
130 mm nominal dia.	9712NB	9530B	9712QNB

Additional information may be obtained by reference to the appropriate data sheets for the standard types.

Each type which carries the suffix "N" is designed to withstand the environmental conditions shown herein and to operate successfully after vibration.



VIBRATION SPECIFICATION

Sinusoidal vibration along three axes, once, with the frequency increasing at a sweep rate of approximately 2 octaves/minute.

Frequency Hz	g/ZZ Axis	g/XX and YY Axes
10-50	2.3	1
50-60	10	3
60-70	14	4
70-80	19	4
80-90	24	6
90-100	30	8
100-200	40	10
200-500	10	4
500-2000	21	4

Random motion along three axes at 0.07g²/Hz, bandwidth 20 to 2000 Hz, 11.5g r.m.s. for 4 minutes each.

At the conclusion of the tests, the tube must be mechanically sound and on electrical retest must meet the original specification.

The above tests are carried out on a small percentage of tubes.

Since experience has dictated that it is unwise to vibrate tubes to be used in the system, because of possible fatigue effects, such tubes are routinely subjected only to the following reduced schedule; the frequency increasing at approximately two octaves/minute.

Frequency Hz	g/ZZ Axis
10-100	2
100-2000	10

Every tube including the designation "N" in its type number is supplied with a test certificate.

Notes

- a) Each tube is individually calibrated and the test ticket furnished with the tube specifies the cathode sensitivity in $\mu\text{A}/\text{lm}$, the overall voltage and the dark current (at 20°C) at:

9644NB	2000 A/lm	9711NB	200 A/lm
9647NB	200 A/lm	9712NB	200 A/lm
9734NB	50 A/lm		
- b) Test data is obtained with a "Standard" dynode chain and cathode -D1 voltage held at:

9644NB	150V	9711NB	300V
9647NB	150V	9712NB	450V
9734NB	150V		
- c) In general, when setting up experiments or designing for equipment, it is desirable to work at, or below, the ticket voltage of the individual tube.
- Any material in contact with the glass envelope must be held at cathode potential. Failure to do so may result in erratic operation and high dark current.
- Take great care in clamping tubes, particularly those with quartz (Spectrosil) windows. Excess pressure may fracture the glass in which case the warranty is void.
- Photomultipliers are affected by magnetic fields and mu-metal shields should be used, (see page 64).
- Window materials, particularly quartz, are permeable to helium. Contact with high pressures of helium should therefore be avoided.

MECHANICAL CHARACTERISTICS

	9644NB	9647NB	9734NB	9711NB	9712NB
Max neck dia.	—	—	—	54 mm	54 mm
Max. envelope dia.	51.5 mm	51.5 mm	29 mm	91 mm	130 mm
Cathode dia.	44 mm (nom)	44 mm (nom)	23 mm (nom)	77 mm (min)	111 mm (min)
Cathode type	"N" types S-11, "QN" types S-13				
Window material: "N"	Borosilicate	Borosilicate	Lime Soda	Borosilicate	Borosilicate
"QN"	Spectrosil	Spectrosil	Spectrosil	Quartz	Quartz
Dynodes	13VB	11VB	9BG All have CsSb secondary emitting surfaces	11VB	11VB
Base	B19A	B19A	B14B	B19A	B19A

All are low loss pressed glass bases furnished with appropriate high quality Teflon socket

ELECTRICAL RATINGS

	9644NB	9647NB	9734NB	9711NB	9712NB
Cathode to D1 max.	300V	300V	300V	350V	500V
Recommended cathode to D1 voltage	150V	150V	150V	300V	450V
Cathode to anode max. (subject to not exceeding)	2500V 5000A/lm	2200V 2000A/lm	1800V 200A/lm	2350V 2000A/lm	2500V 2000A/lm
Overall sensitivity: Rated Max.	2000 A/lm 5000A/lm	200 A/lm 2000A/lm	50 A/lm 200A/lm	200 A/lm 2000A/lm	200 A/lm 2000A/lm
Max. anode current (mean)	1 mA	1 mA	100µA	1 mA	1 mA
Max. anode dissipation	1W	1W	0.1W	1W	1W
Max. operating temperature	All 60°C				
Min. operating temperature	All -80°C				
Max. tolerable cathode current	0.3µA	0.3µA	0.1µA	1µA	2µA
Anode pulse rise time	9ns	10 ns	17 ns	14ns	15 ns
Anode pulse f.w.h.m.	15 ns	14 ns	30 ns	38 ns	40 ns
Transit time	60 ns	55 ns	65 ns	110 ns	120 ns
Capacitance, anode to all dynodes	8 pF	8 pF	6 pF	8 pF	8 pF
Dark current shot noise Typical (λ peak)	lumens: 3.4×10^{-13} watts: 4.0×10^{-16}	3.4×10^{-13} 4.0×10^{-16}	2.1×10^{-13} 2.5×10^{-16}	3.1×10^{-13} 4.2×10^{-16}	4.9×10^{-13} 6.5×10^{-16}
For recommended dynode chains refer to groups shown on page 14	K,L,M	H,I,J	E,F,F''	H,I,J	H,I,J

	Cathode Sensitivity µA/lm Min. Typ.		Overall Sensitivity 2000A/lm				Overall Sensitivity 5000A/lm			
			V Overall		Dark Current nA		V Overall		Dark Current nA	
			Typ.	Max.	Typ.	Max.	Typ.	Max.	Typ.	Max.
9644NB	50	70	1500	2100	50	500	1650	—	125	—
			200A/lm				2000A/lm			
9647NB	50	70	1250	1800	5	50	1750	—	50	—
9711NB	50	80	1300	1900	5	250	1750	—	50	—
9712NB	50	80	1300	2000	12	500	1650	—	120	—
			50A/lm				200A/lm			
9734NB	50	70	1000	1350	0.5	5	1300	—	2	—

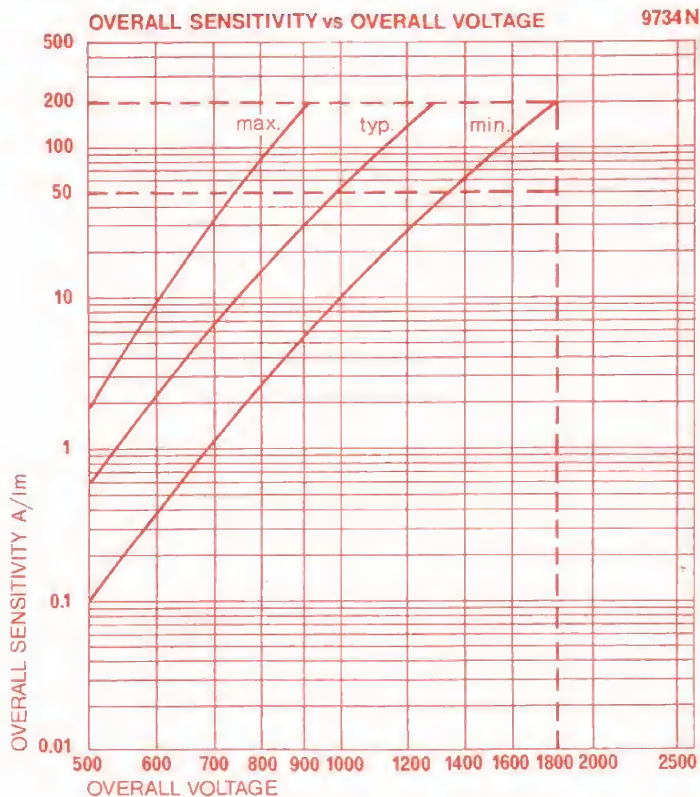
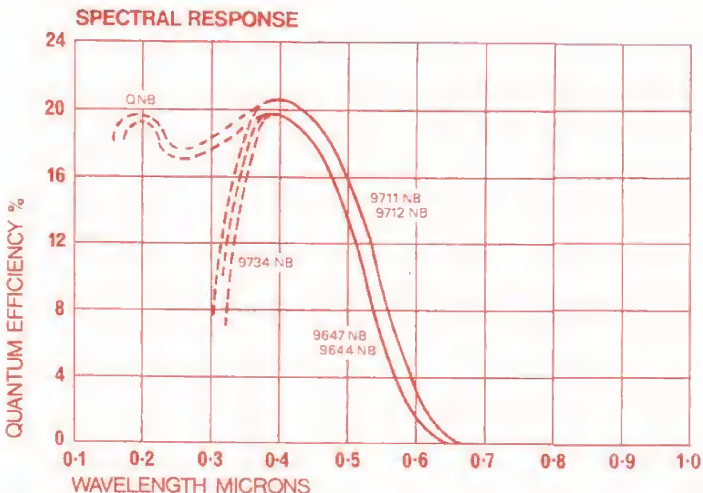

OVERALL SENSITIVITY vs OVERALL VOLTAGE

9647N

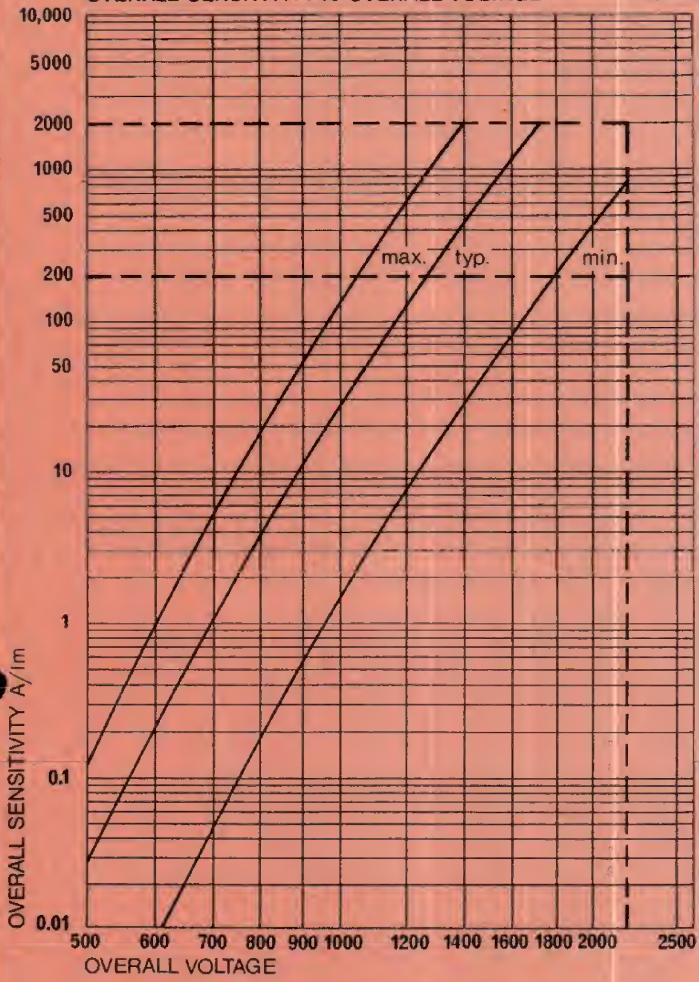

OVERALL SENSITIVITY vs OVERALL VOLTAGE

9644N

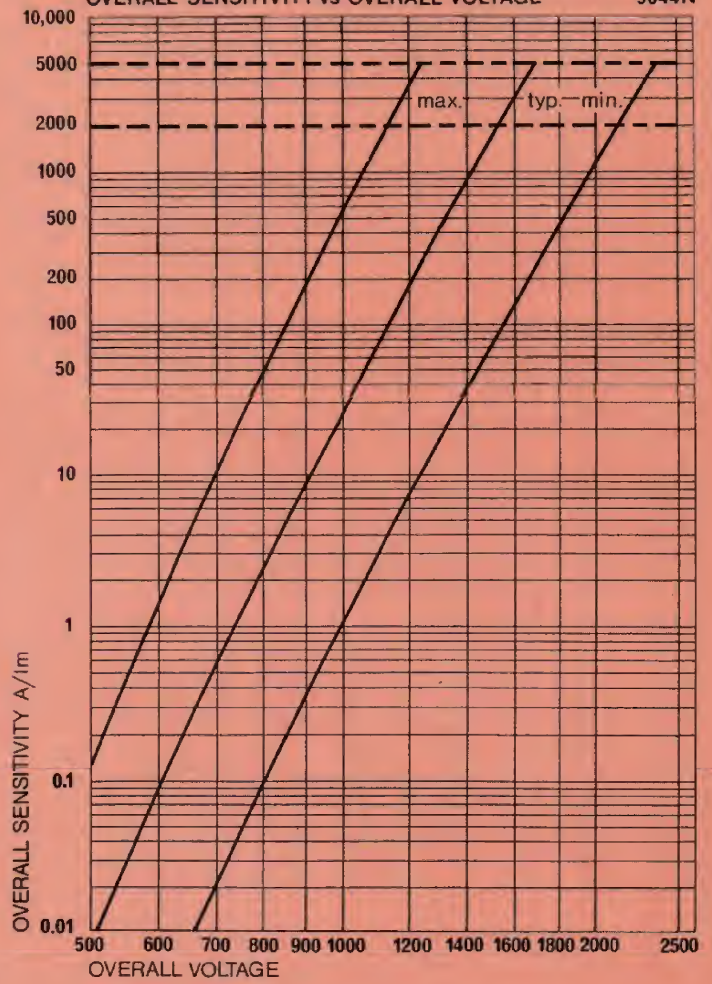

OVERALL SENSITIVITY vs OVERALL VOLTAGE

9711N

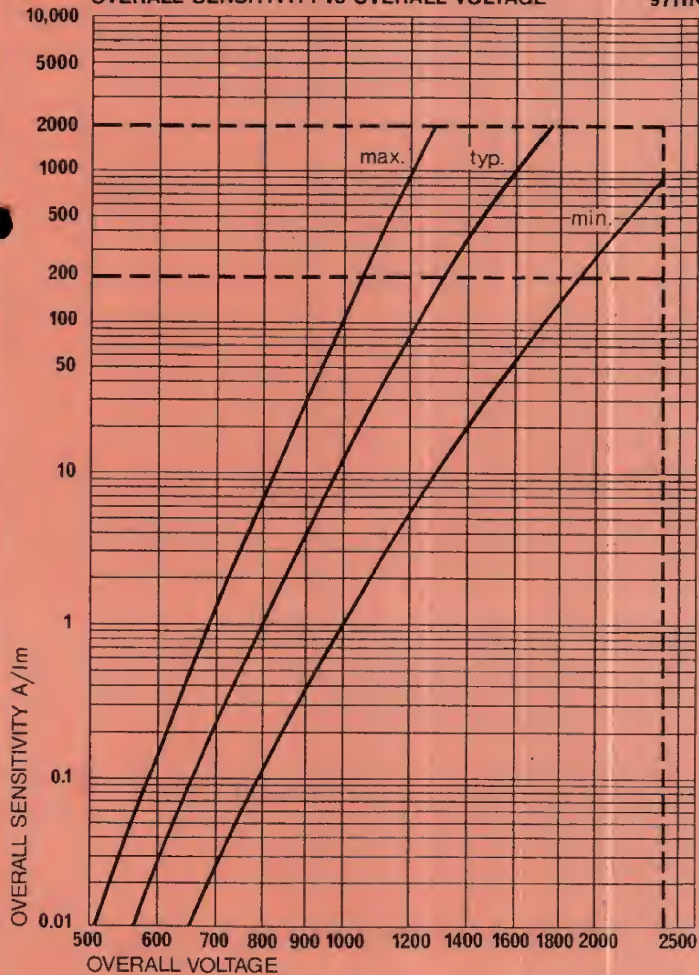

OVERALL SENSITIVITY vs OVERALL VOLTAGE

9712N

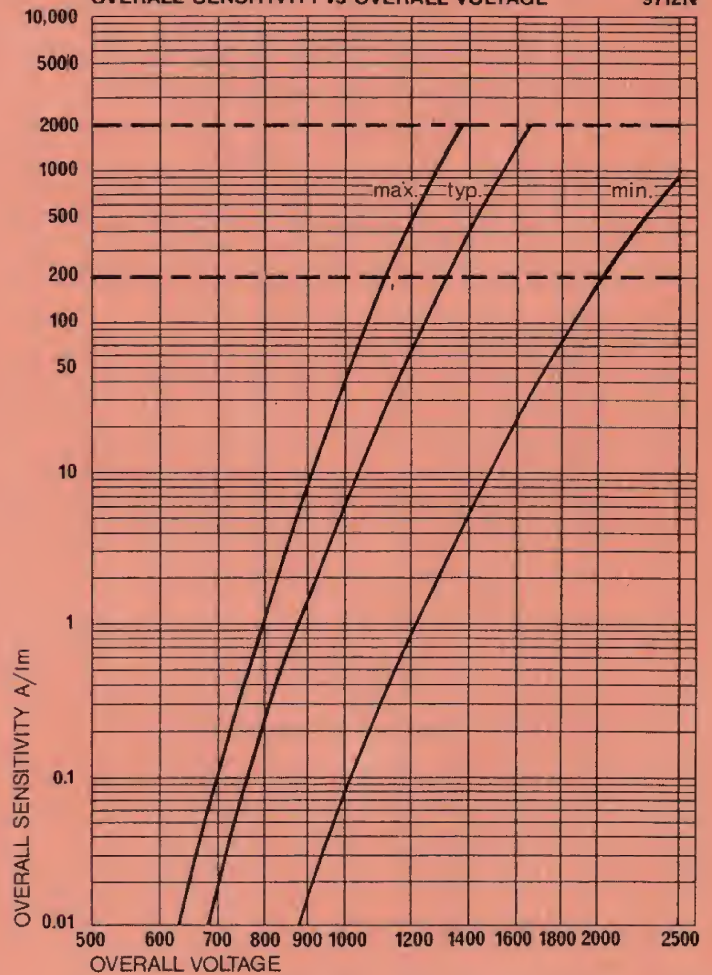

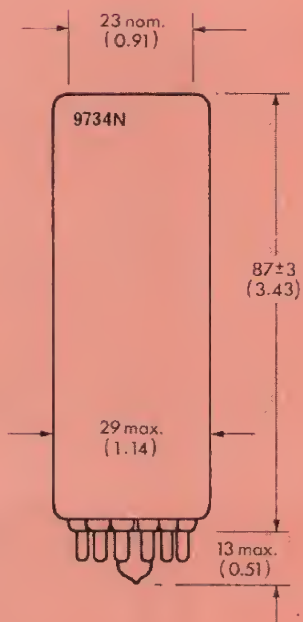
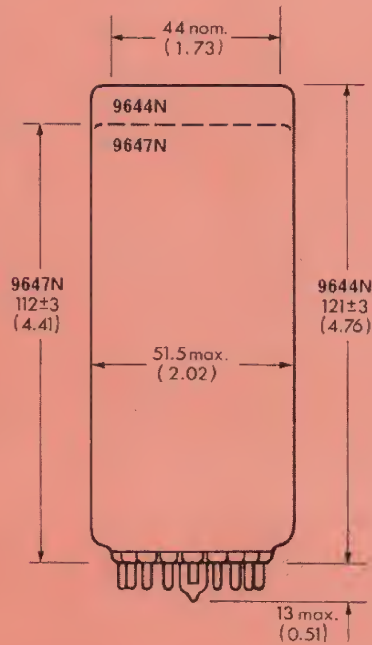
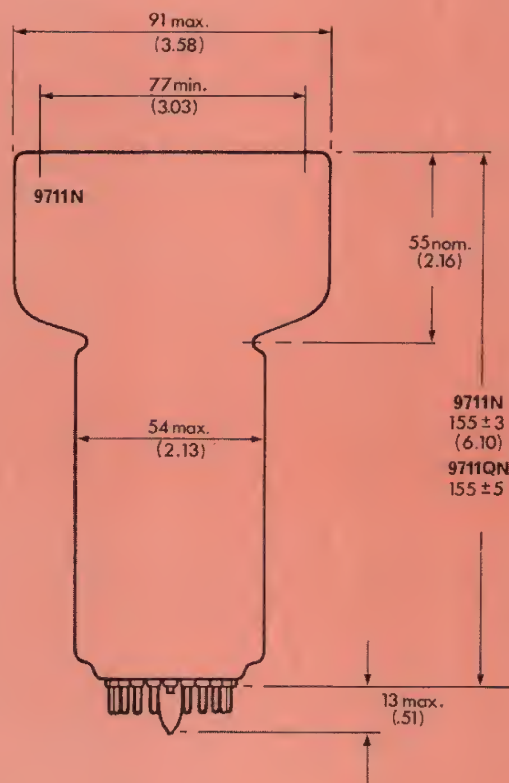
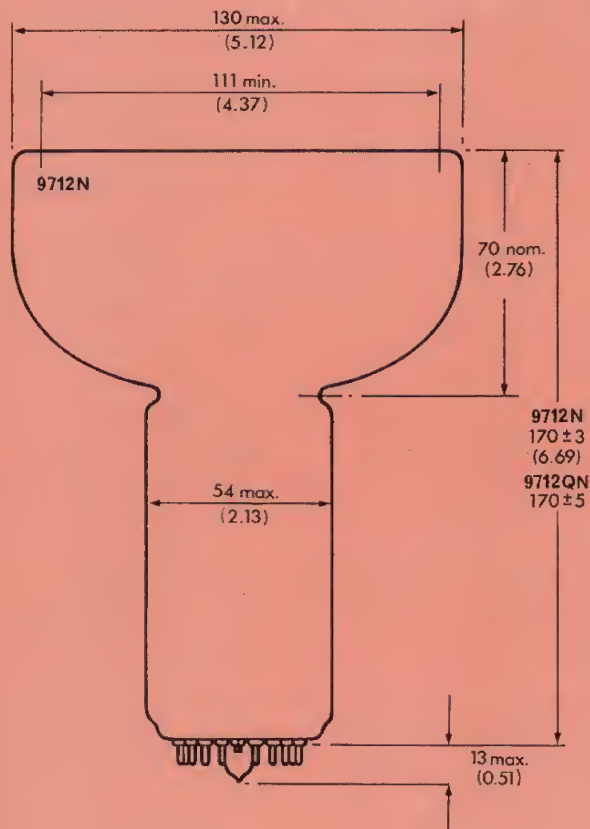

PIN CONNECTIONS (Viewed from below starting left of Short Pin)

Type	1	2	3	4	5	6	7	8	9	10	11	12	13	14	15	16	17	18	19	Socket
9734N	IC	D1	D3	D5	D7	D9	A	IC	D8	D6	D4	D2	K	IC						B14B
9644N	D1	D3	IC	D5	D7	D9	D11	D13	A	IC	D12	D10	D8	D6	D4	IC	D2	IC	K	B19A
9647N	D1	D3	IC	D5	D7	D9	D11	IC	A	IC	IC	D10	D8	D6	D4	IC	D2	IC	K	B19A
9711N	D1	D3	IC	D5	D7	D9	D11	IC	A	IC	IC	D10	D8	D6	D4	IC	D2	IC	K	B19A
9712N	D1	D3	IC	D5	D7	D9	D11	IC	A	IC	IC	D10	D8	D6	D4	IC	D2	IC	K	B19A

All dimensions are in millimetres with inches shown in parentheses.

Sockets

All dimensions are in millimetres with inches shown in parentheses.

Type B14B:

Teflon socket suitable for all 30mm end window and glass base side window tubes.

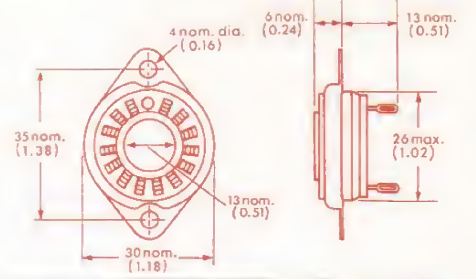

Type B15B:

Teflon socket suitable for all 15-pin glass based tubes.

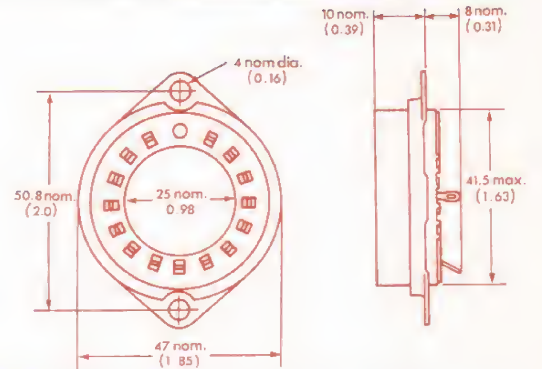

Type B19A:

Teflon socket suitable for all 19-pin glass based tubes.

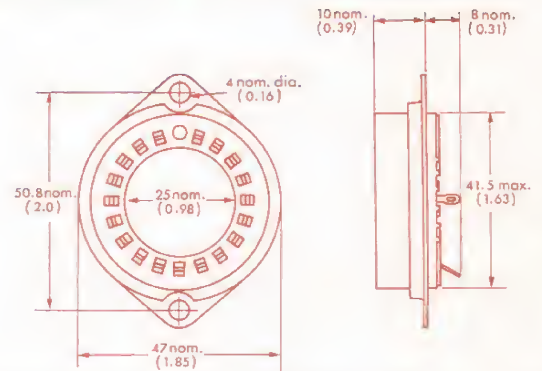

Type B14A:

Polypropylene socket suitable for most overcapped tubes.

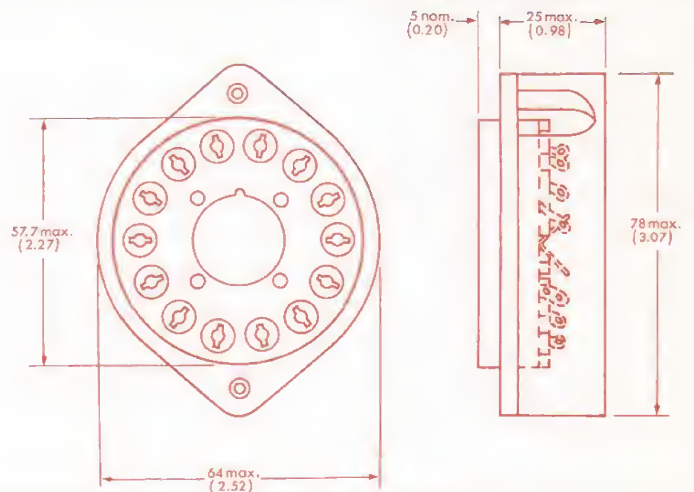

Jedec B20-102:

Suitable for all overcapped fast linear focused tubes.

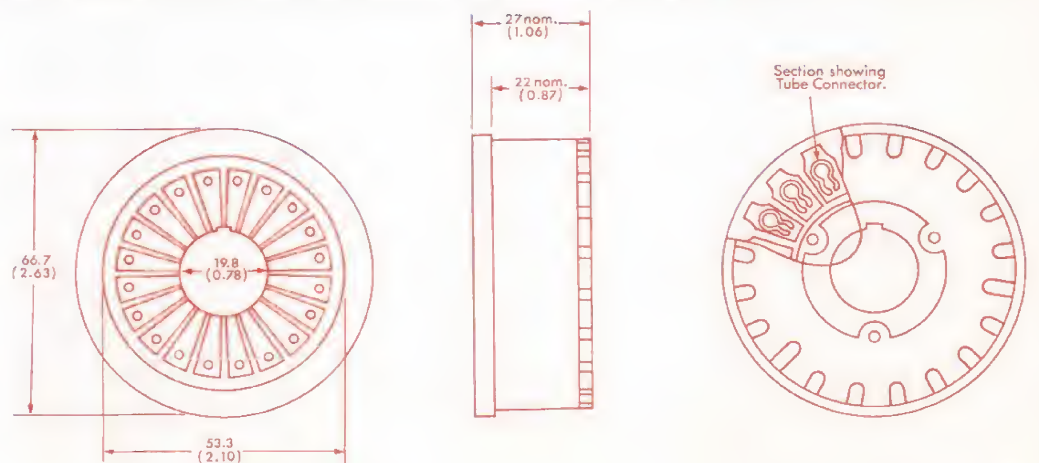

Shields

All dimensions are in millimetres with inches shown in parentheses. Outside dimensions only are shown.

Type PS8A:

Suitable for all 30 mm end window tubes but not side window types. This type grips the photomultiplier and does not require mounting ears.

Types PS5A/B:

Similar types especially suitable for capped 50 mm tubes, but may be used in place of PS6B where a close fitting shield is desired.

Type	A	B	C
PS8A	102 (4.0)	31.2 (1.23)	15.9 (0.63)
PS5A	102 (4.0)	55.0 (2.17)	15.9 (0.63)
PS5B	133 (5.25)	55.0 (2.17)	15.9 (0.63)

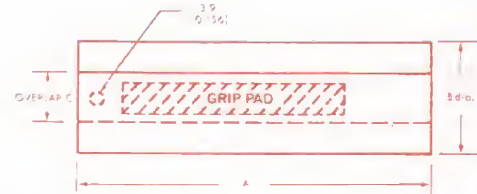

Type PS6A:

Similar to PS6B but with mounting brackets spaced further apart to facilitate use with 50 mm capped tubes.

Type PS6B:

Suitable for most 50 mm tubes. Extensible and has mounting ears to fit Teflon sockets.

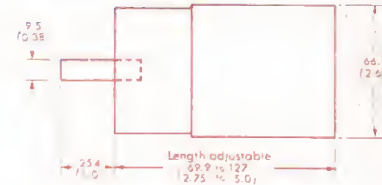

Type PS7B:

Suitable for 75 and 90 mm tubes. Extensible and has mounting ears to fit Teflon sockets.

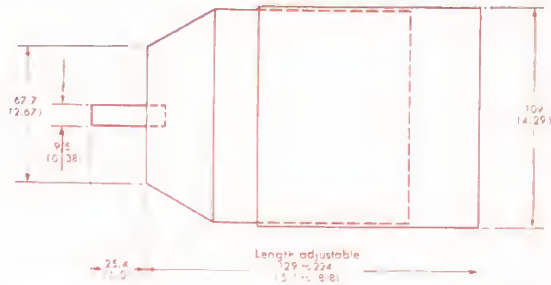

Type PS9B:

Suitable for 130 mm tubes. Extensible and has mounting ears to fit Teflon sockets.

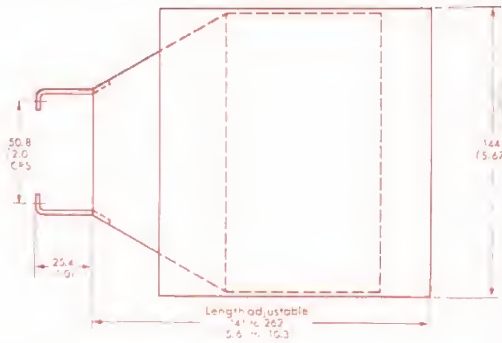

Type PS16B:

Suitable for 190 mm tubes. Incorporates mounting ears to fit Teflon sockets.

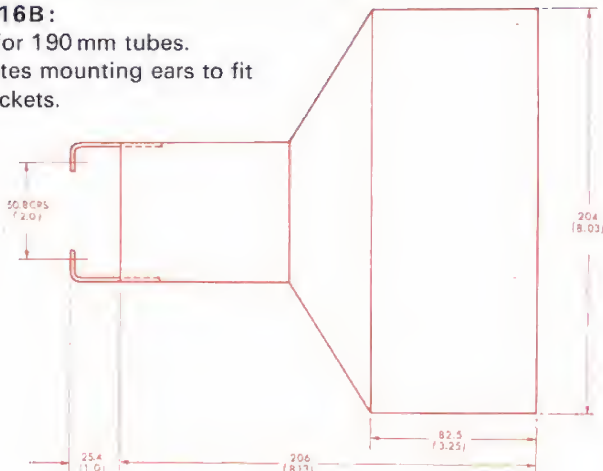

Type PS17B:

Suitable for 310 mm tubes. Extensible and has support rings for neck and bulb of tube.

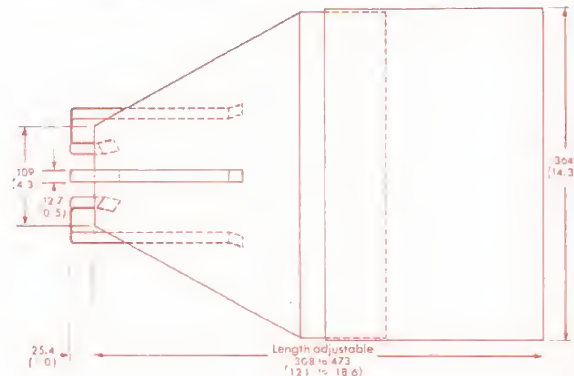



EMI Electronics Ltd Electron Tube Division
Hayes Middlesex England
Telephone : 01-573 3888 Extension 2542
Cables : Emidata, London Telex : London 22417

© EMI Electronics Ltd

