

HGL 1 M34

T.P.I.D.

VOL. 1



B. & K. LABORATORIES LTD.,  
69, UNION STREET, LONDON, S.E. 1.  
TELEPHONE: HOP 4567.

**HUGGINS LABORATORIES**

MENLO PARK 1

CALIFORNIA



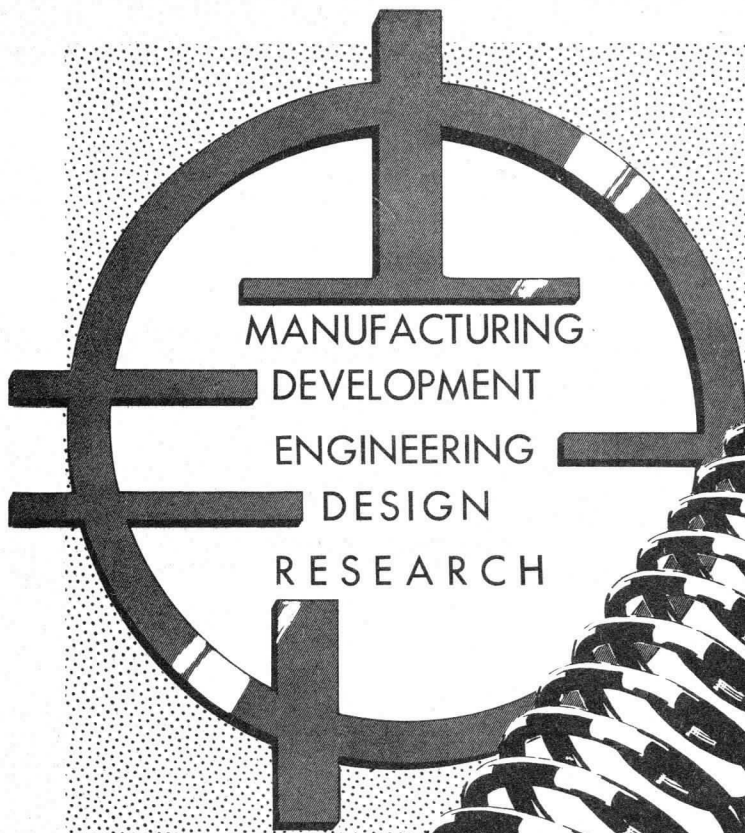

MANUFACTURING  
DEVELOPMENT  
ENGINEERING  
DESIGN  
RESEARCH

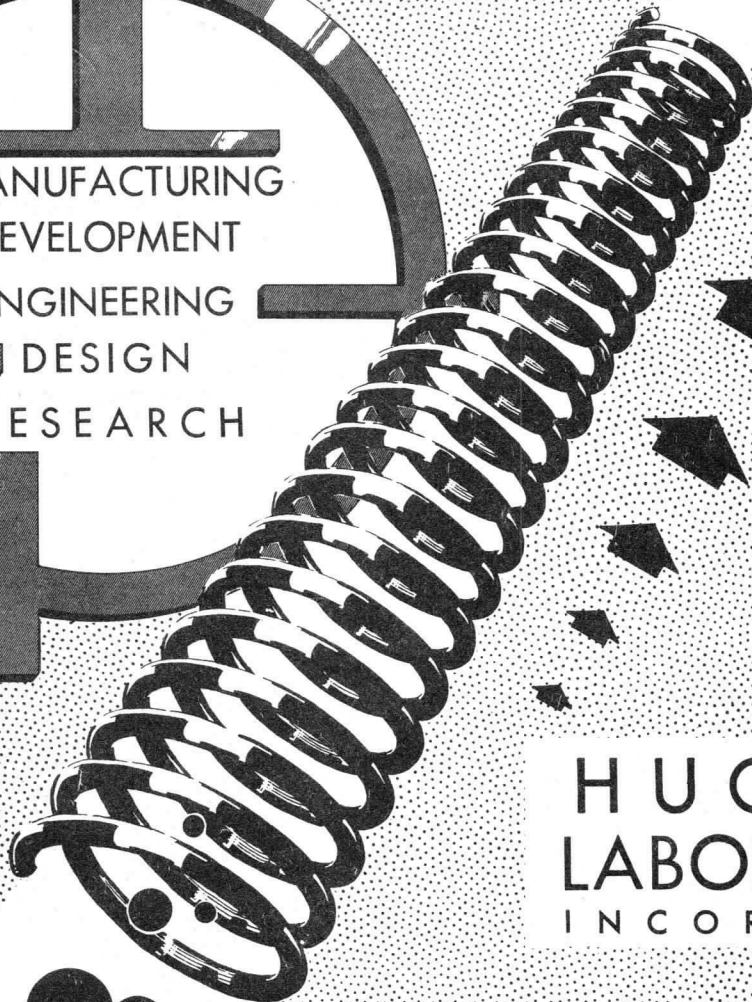

HUGGINS  
LABORATORIES  
INCORPORATED



**TWT** "Traveling-Wave Tube"  
**BWO** "Backward-Wave Oscillator"

B. & K. LABORATORIES LTD.,  
59, UNION STREET, LONDON, S.E.1.  
TELEPHONE: HOP 4567.



## INDEX

<u>Subject</u>	<u>Page No.</u>	<u>Date Issued</u>
Index	I/1	8-1-56
General Information	GI/1-6	1-10-55
Engineering Notes	EN/1-7	1-19-55
Engineering Notes	EN/8-16	7-1-55
Engineering Notes	EN/17-21	8-15-55
Engineering Notes	EN/22-28	10-10-55
Engineering Notes	EN/29-41	5-1-56
Tube Features	A/1-4	1-14-55
Amplifier Tube Chart	AC/1	3-1-56
HA-1B	HA-1B/1-2	12-16-54
HA-2B	HA-2B/1-2	1-5-55
HA-3B	HA-3B/1-2	1-14-55
HA-4B	HA-4B/1-2	1-12-55
HA-5	HA-5/1-2	3-1-56
HA-6	HA-6/1-2	3-1-56
HA-7	HA-7/1-2	7-20-56
HA-9	HA-9/1-2	7-20-56
HA-10	HA-10/1-2	8-22-55
HA-11	HA-11/1-2	8-22-55
HA-12	HA-12/1-2	3-1-56
HA-13	HA-13/1-2	3-1-56
HA-15	HA-15/1-2	7-20-56
HA-17	HA-17/1-2	7-20-56
DHA-1	DHA-1/1-2	5-1-55
DHA-2	DHA-2/1-2	5-1-55
DHA-3	DHA-3/1-2	5-1-55
Oscillator Tube Chart	OC/1	7-1-55
HO-1A	HO-1A/1-2	7-1-55
HO-2B	HO-2B/1-2	3-1-55
HO-2B Supplement	HO-2B/3	8-22-55
HO-3A	HO-3A/1-2	7-1-55
HO-4B	HO-4B/1-2	7-15-55
Solenoid Chart	SC/1	2-15-56
Solenoid Chart	SC/2	2-15-56
Price List	PL/1	8-1-56
Sales Representatives		

HUGGINS LABORATORIES, INC.  
 711 Hamilton Avenue  
 Menlo Park, California

I / 1 / 8-1-56



# WAVE TUBES

● BACKWARD WAVE OSCILLATORS

● BACKWARD WAVE AMPLIFIERS

● FORWARD WAVE AMPLIFIERS



*duplicate copy  
M. Bain*



# HUGGINS

LABORATORIES, INC.

**PIONEER** . . . . .  
in the Traveling Wave Tube Industry



# TRAVELING WAVE TUBES

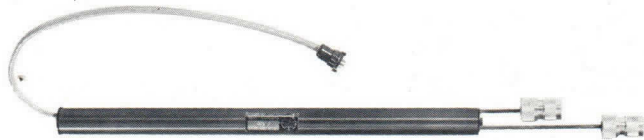

The efforts of Huggins Laboratories are solely devoted to the traveling wave tubes. This device, invented in 1944, is still a mere infant. It is finding wider and wider acceptance for use in very high frequency (microwave) systems the world over.

The traveling wave tube finds use in radar transmitters and receivers, electronic counter measure equipment, missile test and evaluation equipment, microwave component test sets, and radio astronomy, to name but a few applications.

manufacture  
development  
engineering  
design  
research



**RICHARD A. HUGGINS**  
President and general manager

Huggins Laboratories is one of those rapidly growing electronic enterprises which are so typical of the San Francisco Bay area.

Starting with one employee in 1952 (Richard A. Huggins) and adding eleven in 1953, the plant space and number of employees has doubled each year. The beginning of 1958 saw 120 employees rubbing elbows in quarters rapidly becoming prohibitively small at the Menlo Park location. As a pioneer in the traveling wave tube industry, Huggins Laboratories has periodically expanded its facilities to keep pace with the fast growing industry.

A new plant, occupancy to be made in the early Fall of 1958, will allow for expansion to 400 employees with its 30,000 square feet of space. The site is in the Sunnyvale Development Center, recently opened to light industries largely involving electronics manufacturers.



T. P. file

# ATTENTION

PURCHASING AGENTS • ENGINEERS

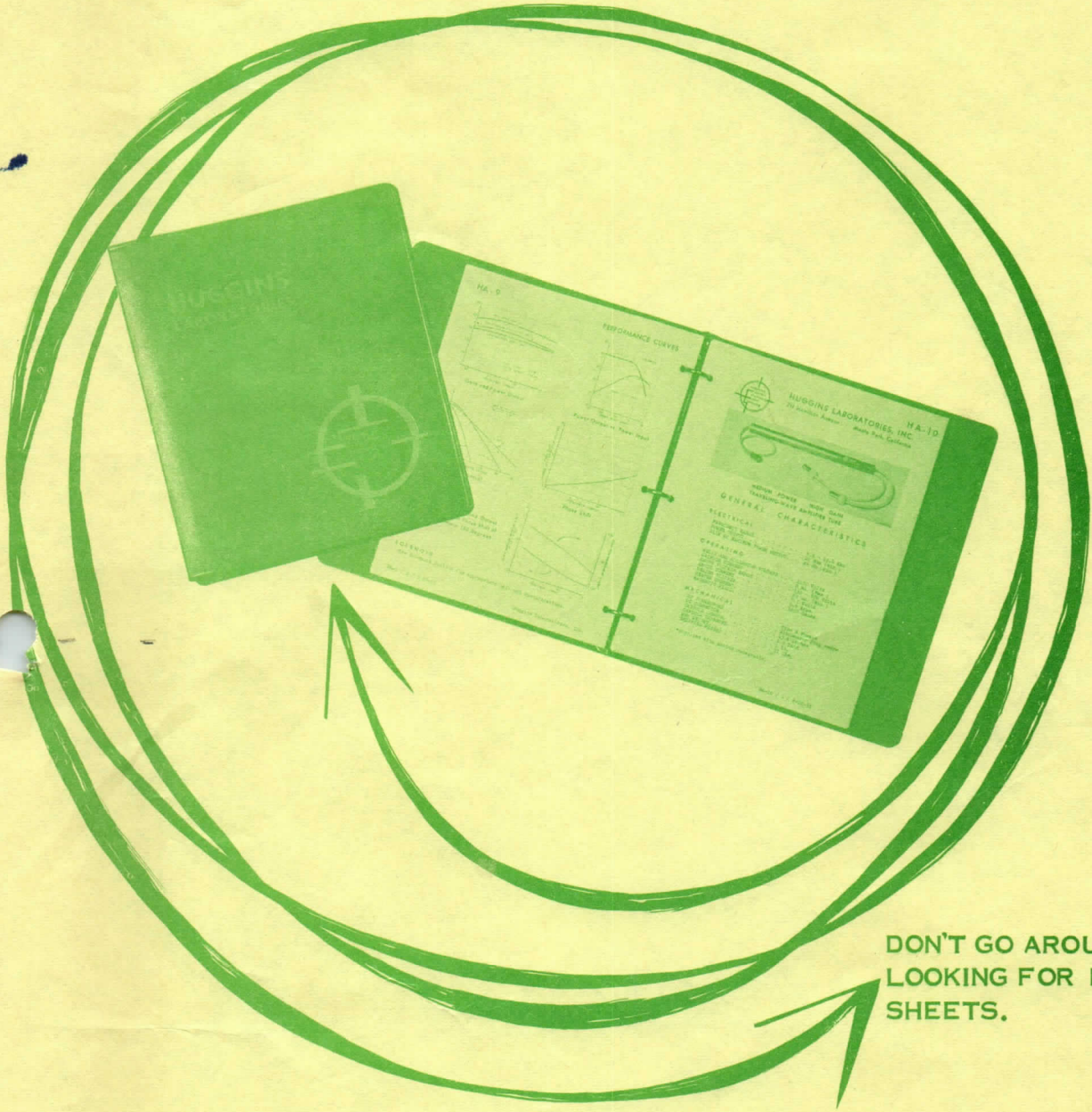

DON'T GO AROUND IN CIRCLES  
LOOKING FOR HUGGINS DATA  
SHEETS.

OUR HANDSOME TWO-VOLUME SET OF LOOSE-LEAF BINDERS IS NOW AVAILABLE FOR THE HUGGINS ENGINEERING NOTES AND TRAVELING-WAVE TUBE DATA SHEETS. MADE OF LONG WEARING SIMULATED LEATHER, THE BINDERS MAKE INFORMATION OF OUR PRODUCTS EASILY AVAILABLE AT YOUR DESK OR WORKBENCH.

WRITE FOR YOUR SET TODAY  
PRICE: \$1.00 PER SET

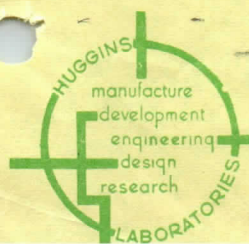

HUGGINS LABORATORIES  
711 HAMILTON AVENUE, MENLO PARK, CALIFORNIA.



# GENERAL INFORMATION ON TRAVELING-WAVE TUBES

## Introduction

Engineers who design and build circuits which use conventional low frequency vacuum tubes usually have at least a speaking acquaintance with the theory upon which these tubes operate. In designing their circuits or in deciding which type of tube to use, careful use is made of the various characteristic curves associated with the tubes. It is the purpose of the following brief discussion to similarly acquaint the applications engineer with the simple theory of the operation of the traveling wave tube and to familiarize him with the various characteristic curves which describe its operation. From this discussion, it is hoped that the data sheets contained in this catalog may take on added meaning and that a better understanding of the basic functions of the traveling wave tube may be obtained.

## Microwave Amplification

As the microwave region of the radio frequency spectrum has come into practical engineering use, engineers have been constantly on the lookout for devices which could function as better amplifiers and oscillators. In the frequency range above a few hundred megacycles conventional vacuum tubes no longer amplify properly because the period of one cycle of the radio frequency wave approaches the time it takes the electrons to travel from cathode to anode within the tube. As a result the amplification factor of the tube decreases with increasing frequency until no useful gain can be obtained. This is known as the transit time effect.

The first devices which served as practical amplifiers above a few hundred megacycles actually made use of transit time effects. These devices are known as klystrons and became useful primarily as oscillators although they are also capable of acting as amplifiers. Klystron amplifiers are capable of giving high values of amplification, but they have one serious limitation for many applications. They are relatively narrow band devices; having usually no more than a few megacycles bandwidth between half-power points. Tuning of the amplifier to different frequencies requires a mechanical adjustment. The klystron is, however, the forerunner of a whole general class of microwave electron devices which utilize transit time effects in electron beams. This general class of devices includes the traveling wave tube.

A klystron is a narrow band device because it involves the use of a very sharply resonant, high-impedance tuned circuit. It is necessary for a klystron to use such a circuit because interaction takes place with the electrons over only very short

physical distances and it must develop high electric fields to have efficient interaction with the electrons. However, it was reasoned that one might obtain a very broadband amplifying device if one used a low-impedance, broadband circuit which developed relatively small electric fields but which interacted with the electrons over a long physical distance. Such is the basis on which the traveling wave tube works and this basic concept has led to a wide range of devices which are useful as broadband amplifiers and oscillators in the microwave region.

The traveling wave tube is basically capable of giving high values of amplification over wide frequency ranges without requiring the change of any mechanical tuning mechanism or the variation of any voltages or currents applied to the tube. Power amplification greater than 10,000 (ie., 40 db gain) over a 2:1 frequency range has been obtained with this type of tube. The actual number of megacycles covered by such tubes can be a staggering figure. An operating bandwidth of 2000 megacycles has been obtained in one typical tube type; 7000 megacycles has been obtained in another.

Tubes can be built which emphasize various special characteristics. For instance, tubes can be built which have low noise properties, or high power output, or controlled variations of gain with frequency. Many special tubes have been designed and built for particular applications.

#### Simple Description of Theory of Operation (Forward-wave Helix Type Amplifier)

One of the simplest circuit elements which satisfies the broadband low-impedance circuit requirement of the traveling wave tube is a simple helical transmission line. On this so-called helix, the radio frequency energy essentially travels at the velocity of light along the wire from which the helix is wound. But since the wire and the energy follow this helical path, the actual progress of the energy along the axis of the helix is at some fraction of the velocity of light. This velocity is determined by its dimensions (ie., its circumference and pitch) and by the dielectric loading due to the structure which supports the helix. The fields associated with this "slow-wave" extend outward and inward into the regions adjacent to the helix and it is into these regions that electrons are sent to interact with the waves.

If electrons are sent along the axis of the helix at essentially the same velocity as the waves, an interaction between waves and electrons occurs wherein the electrons become bunched and then become packed into tighter and tighter bunches as the electrons progress down the helix. Simultaneously, the radio frequency fields on the helix increase in magnitude as they progress down its length. The increase in energy of this "growing wave" is just balanced by a decrease in the average kinetic energy of the electrons in the beam. In other words, the electrons on the average have been slowed down and have given up just enough energy by this slowing down process to account for the increasing energy or power level in the waves on the helix.



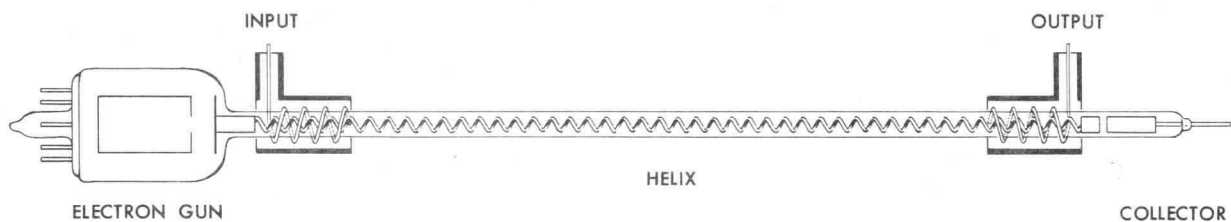

FIG. 1

Schematic View of Traveling-Wave Tube

In practice, the electron beam is formed in a gun and is focused down the center of the helix to a collector electrode on the farther end (see Figure 1). The velocity of the electrons is determined by the voltage difference between the cathode in the electron gun and the helix, and this is adjusted to give the electrons just the right velocity for interaction with the waves. The signal to be amplified is coupled onto the end of the helix nearest the electron gun and propagates along the helix in the same direction as the electron beam. Because of the interaction, the fields on the helix grow exponentially with distance and these amplified waves are coupled off of the helix at the end farthest from the electron gun. The devices which couple the energy on and off the helix at its beginning and end are connected to the input and output transmission lines. The electron beam that is formed in the gun is maintained in a tight pencil beam throughout the length of the tube by the confining forces of a longitudinal magnetic field which surrounds the tube.

The devices which couple the energy onto and off of the helix are special directional couplers which are in themselves helices. These helices, which are outside of the vacuum envelope of the tube, are matched to the input and output coaxial transmission lines. They are capable of transferring most of the energy from the lines to the main helix, which is inside the vacuum envelope, without having to make physical contact to the helix. These "coupled helix matches" have the additional advantage that they have very wideband transfer characteristics and are capable of presenting a standing-wave ratio to the coaxial transmission line of 1.5:1 or less.

### Specific Characteristics

In the following sections, the various characteristic curves that are encountered in operation of the traveling wave tube are shown and discussed.

#### Helix Voltage vs. Frequency

Usually a helix will be designed such that the "slow-waves" travel at a velocity in the range of  $1/10$  to  $1/30$  of the velocity of light. If the velocity of the waves is examined as a function

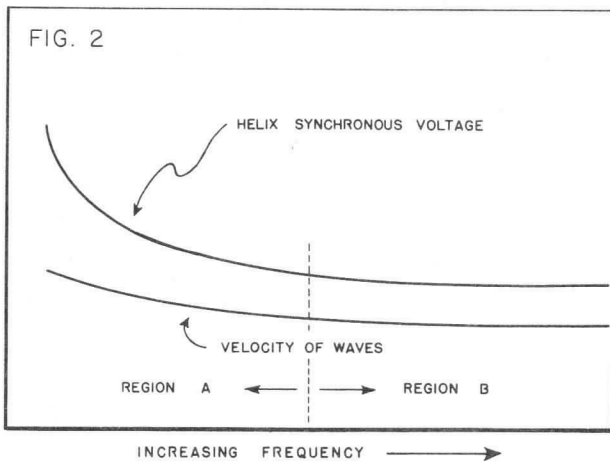

FIG. 2 PHASE VELOCITY OF THE WAVES AND SYNCHRONOUS HELIX VOLTAGE AS A FUNCTION OF FREQUENCY.

of frequency it is found a helix will have a general characteristic curve similar to that shown in Figure 2.

There is a region A where the velocity of the waves varies as a function of frequency, and there is a region B where the velocity of the waves is essentially independent of frequency. It is in this region B, known as the "non-dispersive region", where a broadband amplifier is normally operated.

As mentioned before, it is necessary to have the electrons travel down inside the helix at essentially the same velocity as the waves (synchronous velocity) in order to obtain the growing wave interaction. Thus if the velocity of the wave varies as a function of frequency, the velocity of the electrons must also be varied so that interaction is maintained. Since the velocity of the electrons is determined by the voltage difference between the cathode and the helix, there is also a characteristic curve of synchronous helix voltage as a function of frequency which is shown in Figure 2.

The reason why a helix type traveling wave tube can amplify over wide bandwidths without changing helix voltage can now be easily seen. In the region B, the non-dispersive region, the synchronous voltage of the electrons is essentially independent of frequency. That is, the helix voltage which gives the desired interaction between the waves and electrons can be fixed at one value and this will be the correct value to provide interaction and amplification over a wide range of frequencies.

### Gain vs. Helix Voltage

To obtain the greatest interaction between the waves and the

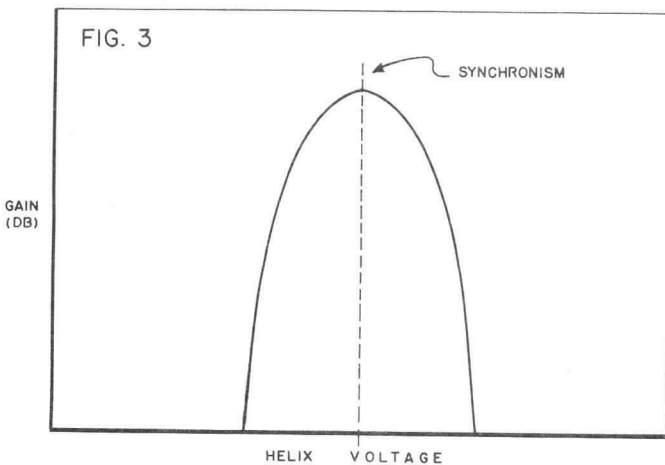

FIG. 3 GAIN AS A FUNCTION OF HELIX VOLTAGE.

electrons and thus the greatest amplification, the helix must be operated at synchronous voltage. If the helix voltage is varied away from synchronism, the gain will decrease as shown by the curve in Figure 3 which is parabolic in shape.

### Gain and Power Output vs. Frequency

Figure 4 shows a typical plot of gain vs. frequency for a fixed value of helix voltage. Small signal gain is obtained.



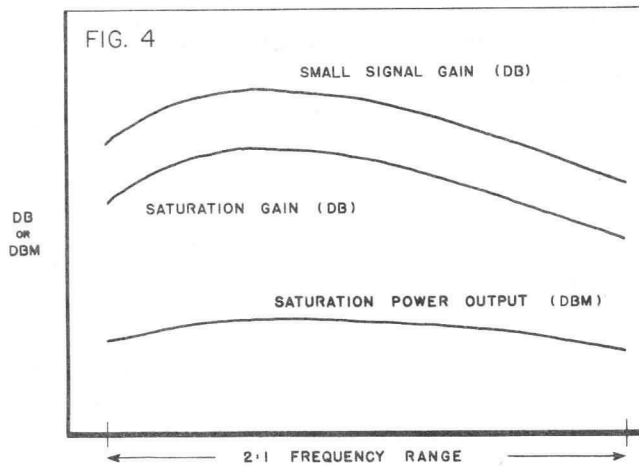

FIG. 4 GAIN AND POWER OUTPUT AS A FUNCTION OF FREQUENCY.

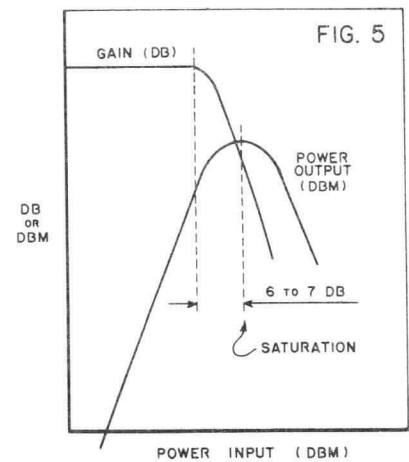

FIG. 5 GAIN AND POWER OUTPUT VS. POWER INPUT AT A FIXED FREQUENCY.

for all values of input signal level except those which drive the tube near its maximum or saturation power output. Saturation gain is the gain obtained when the tube is driven to its maximum or saturation power output. It is seen that the gain and power output curves generally have a maximum near the center of the band and that the curves droop off towards the band ends.

#### Power Output and Gain vs. Power Input

Figure 5 shows a typical variation of power output and gain vs. power input at a fixed frequency. The amplifier is linear until power input is within 6 to 7 db of the value which drives the amplifier to saturation. At this point the power output curve begins to droop over, and gain of the tube begins to decrease. At saturation the power output is a maximum and the gain has decreased to a value which is called saturation gain. As the tube is driven beyond saturation the power output drops off and gain continues to decrease. To obtain maximum power output from an ordinary traveling wave tube, just the right amount of power input must be applied. The saturation region does not exhibit the leveling off or flat saturation characteristic that is found in conventional low frequency amplifier tubes.

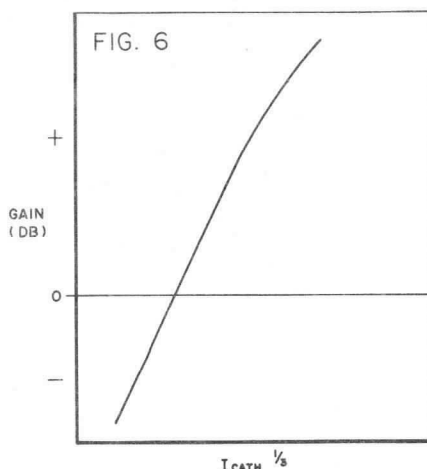
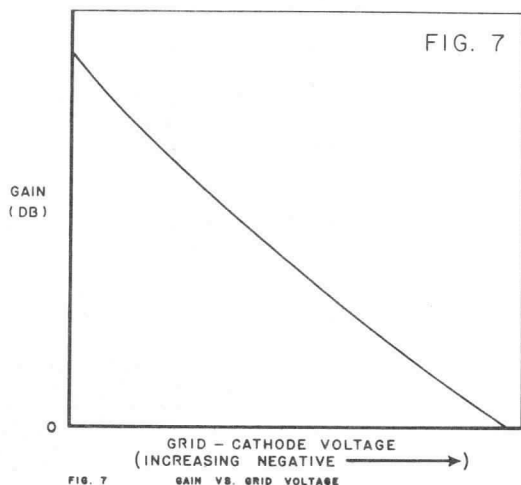

FIG. 6 GAIN VS. BEAM CURRENT

#### Gain vs. Beam Current and Grid Voltage

Figure 6 shows that the gain at any fixed frequency is essentially a function of the  $1/3$  power of the beam current and decreases as beam current is decreased. Figure 7 shows that as the grid electrode is made negative with respect to the cathode, the gain of the tube decreases. This results from the fact that operating the grid negative with respect to the cathode causes the beam current to decrease.

If the beam current is decreased below a certain value as shown in Figure 6, the gain of the tube measured in db becomes



negative, ie., the tube is acting as an attenuator. If the beam current is reduced to zero, the net "cold" attenuation of the tube is available. The total change in signal output level as beam current is decreased from its normal value to zero is equal to the sum of the net gain of the tube plus the cold attenuation. This can approach a variation in signal level of about 100 db. This is accomplished merely by varying the control grid voltage.

## Special Characteristics

### Low Noise Amplifiers

On a typical low power amplifier one may find a noise figure of 20 db. Certain applications require lower noise figures than this. Techniques are available in electron gun design whereby the "shot noise" in the beam can be "de-amplified" before it reaches the beginning of the helix. Special purpose tubes built in this fashion have reached noise figures as low as 6 db.

### Narrow Band Amplifiers

Where an application does not require extremely wide bandwidths, tubes have been built which operate in the dispersive region of the tube characteristics where the velocity of the waves varies as a function of frequency (see Figure 2). In this region operation at a fixed voltage leads to amplification over only a relatively narrow band of frequencies. Extremely high values of gain (eg. 60 to 70 db gain) have been obtained because the problem of controlling spurious oscillations is much simplified since the tube exhibits gain over only a relatively narrow band.

### Special Gain Variation

Sometimes special requirements are imposed on the gain variation of the tube as a function of frequency. Tubes have been built which exhibit an essentially constant value of gain across the band. Others have been built which have linearly increasing gain with frequency. Various other combinations are also possible.



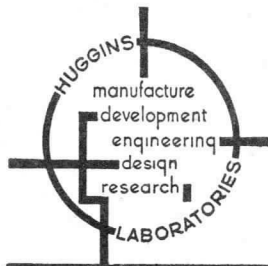

# HUGGINS LABORATORIES ENGINEERING NOTES

VOL. I, NO. I

JANUARY 1955

Published by Huggins Laboratories

Menlo Park, California

## MEASUREMENT TECHNIQUES

As traveling wave tubes have come into more common use, the need has become apparent for a clarification of the various measurement techniques involved in an evaluation of the tube characteristics. Since the traveling wave tube is a very broadband device the emphasis must be upon broadband, untuned measuring techniques and test equipment. Otherwise, much time will be lost in the repetitive and laborious adjustment and tuning of narrow band devices to make point by point measurements across wide frequency ranges.

It will be noticed that the emphasis on measuring equipment has been placed upon coaxial systems. This is done, obviously, because of the inherent wideband properties of coaxial test equipment. Waveguide equipment is used only where equivalent coaxial equipment is not available or will not do an equivalent job.

The various types of broadband test equipment commonly used are listed below:

1. Self-tracking tunable signal generator with calibrated power output.
2. Untuned coaxial crystal detector.
3. Untuned coaxial bolometer or thermistor mount with self-balancing power bridge.
4. Broadband coaxial fixed attenuator.
5. Coaxial switch (SPDT).
6. Coaxial slotted section (for VSWR measurement) with untuned detector.
7. Coaxial or waveguide directional coupler.
8. Fluorescent noise source.

The characteristics to be measured comprise essentially the following list.

1. Gain
2. Power Output
3. Standing Wave Ratio or Reflection Coefficient
4. Insertion Loss
5. Noise Figure

## PROCEDURES

### A. Measurement of Gain

The most rapid and satisfactory method of measuring gain is to make an insertion gain measurement using the substitution method. This method does not require a knowledge of the detector characteristics nor an absolute power calibration of the signal generator. Its accuracy depends only upon the calibration accuracy of the output attenuator of the signal generator.

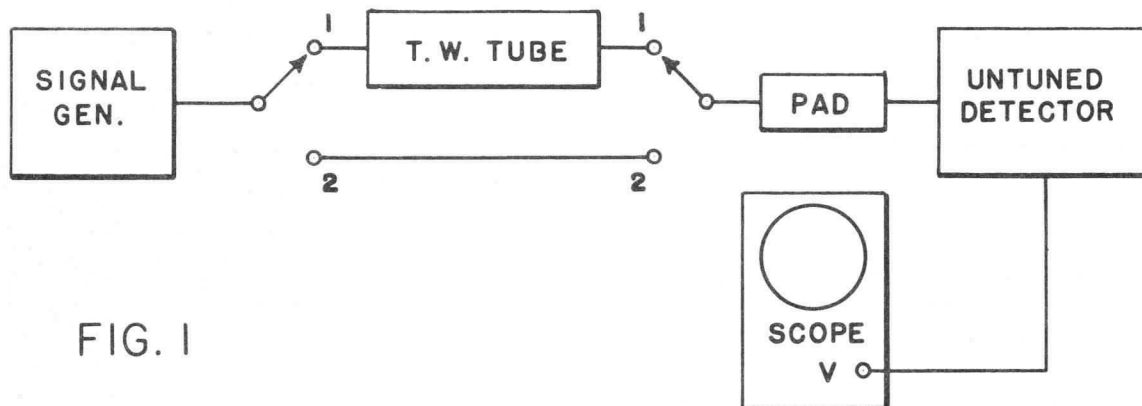

FIG. 1

BLOCK DIAGRAM OF GAIN MEASUREMENT SET-UP

As shown in the block diagram of Figure 1, the output of the signal generator (which has a matched 50 ohm output) is fed to the input of the tube through a coaxial single-pole double-throw switch. The output of the tube is fed through another coaxial switch and at least a 6 db coaxial fixed attenuator pad to the untuned detector. The pad can be eliminated if the detector is matched. The output of the detector is fed to the vertical deflection channel of an oscilloscope. The tube is by-passed when the switches are thrown to the other position.

#### Procedure:

Apply pulse or square wave modulation to the signal generator. With the tube operating and the switches in position 1, the output attenuator of the signal generator is adjusted to give some convenient deflection on the scope. This is attenuator reading 1. The switches are then thrown to position 2 and the attenuator readjusted to give the same deflection on the scope. This is attenuator reading 2. The insertion gain of the tube is then the difference of the attenuator readings 1 and 2 measured in db.

#### Precautions:

1. Both the signal generator and the detector must present good impedance matches as seen by the switch. If they are not matched, then reflection losses can give up to several



db error in gain. This is the reason for the pad ahead of an unmatched detector. A 6 db pad guarantees a VSWR of at most 1.5:1.

2. The switch used must have a low VSWR and very low crosstalk. Crosstalk is the stray feedthrough from input terminal to output terminal of the DPDT switch combination through the unused channel of the switch. Crosstalk ratio is measured by disconnecting the tube from terminals 1, and measuring the difference in signal generator attenuator reading with the switches in position 1 and position 2 for the same deflection on the scope. This crosstalk ratio should be at least 20 db greater than the gain of the tube to be measured. This prevents regenerative feedback around the switch which will give errors in gain measurement. If the crosstalk ratio is greater than about 45 db, it probably cannot be measured with the setup of Figure 1. See section D on insertion loss measurement.

3. If small signal gain is to be measured, care must be taken that the output power level of the tube is at least 10 db below the saturation power level. This eliminates errors due to the decreasing gain characteristic of the traveling wave tube in the region near saturation.

#### B. Measurement of Power Output

When power measurements are to be made over wide frequency ranges, it is convenient to use broadband (untuned) bolometer or thermistor mounts as power detectors. When these mounts are operated in conjunction with a self-balancing wattmeter bridge they provide a convenient system for the measurement of absolute power.

If the power level to be measured is greater than the maximum allowable power input to the mount, then it is necessary to insert a calibrated attenuator pad ahead of the mount. The most convenient type of pad to use is the resistive film type which has attenuation characteristics which are essentially independent of frequency. Care must be taken not to exceed the maximum input rating of the attenuator.

If power levels to be measured are greater than the rated dissipation of standard attenuator pads, then a directional coupler must be placed on the output of the tube. The main arm of the coupler is terminated with a broadband load and the power detector with appropriate pads is placed in the auxiliary arm of the coupler. Broadband coaxial directional couplers with coupling ratios of 10 and 20 db from main arm to auxiliary arm are available.

If gain measurements are to be made in conjunction with the power measurements then the power output of the signal generator must be calibrated using its power monitor at each

frequency. For the sake of accuracy, the power output reading of the signal generator should be initially checked using the bolometer mount and the wattmeter bridge at least over the range of power levels that the bridge can accurately read. If care is taken to check the calibration of the attenuator pad and the signal generator, then the small signal gain measurements obtained with this equipment should check with small signal gain measurements made by the method of section A.

If all power measurements are recorded in terms of dbm (ie., db with respect to one milliwatt), then the readings of the power bridge, the attenuator (in db) and the signal generator need be merely added and subtracted to obtain power output and gain. Conveniently, most signal generators and power bridges are calibrated in dbm as well as milliwatts.

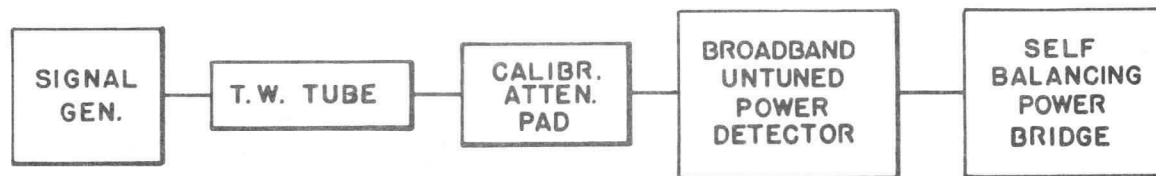

FIG. 2 BLOCK DIAGRAM OF POWER MEASURING SET-UP

Figure 2 shows the block diagram of the power measurement setup. The power output is then given by the equation:

$$P_{\text{out}} \text{ (dbm)} = \text{Pad Attenuation (db)} + \text{Ratio of Directional Coupler (db)} + \text{Power Bridge Reading (dbm)}$$

The gain of the tube is given by the equation:

$$\text{Gain (db)} = P_{\text{out}} \text{ (dbm)} - P_{\text{in from Sig. Gen.}} \text{ (dbm)}$$

The above gain measurement is valid not only for small signal gain, but also for gain measured in the saturation region and beyond.

#### C. Measurement of Standing-Wave Ratio or Reflection Coefficient

For direct measurement of Voltage Standing-Wave Ratio (VSWR) the coaxial slotted line is the simplest. To speed up broadband measurements, however, it is essential to have an untuned detector on the slotted line.

For situations where it is necessary to examine the VSWR continuously over a wide frequency range and where fast checks are required such as on production test setups, the slotted line type of measurement becomes prohibitively time consuming and laborious. For such situations, the measurement of reflection coefficient through the use of directional couplers is recommended. Two directional couplers connected so that one will give an output proportional to the incident wave and the other an output proportional to the reflected wave from the



load can be used. These two outputs can be detected and compared with a ratiometer to give a direct reading of reflection coefficient. The reflection coefficient can be converted to equivalent VSWR if necessary. The higher the accuracy required in the measurement of reflection coefficient, the higher the directivity of the directional couplers must be. In waveguide, directivity greater than 40 db over the waveguide range can be obtained which allows measurement of reflection coefficient of 0.1 with an accuracy of plus or minus .02. This means that a load VSWR of 1.2 will give an indicated reading between 1.15 and 1.25. A waveguide to coaxial transition can be used to adapt the reflectometer to coaxial systems. In this case, the residual reflection in the transition limits the accuracy at low VSWR.

Using such a reflectometer setup, once the initial calibration is performed it is necessary only to tune the signal generator across the frequency range and the reflection coefficient values read directly. An excellent detailed discussion of this method, its errors and limitations, is given in the Hewlett-Packard Journal, Volume 6, Number 1-2, Sept.-Oct., 1954.

Even faster measurements can be made when a swept oscillator is employed. Reflection coefficient can be displayed directly on a scope as a function of frequency and the measurement can be made at a glance.

#### D. Measurement of Insertion Loss

It is often necessary to measure insertion loss in the range of 40 to 100 db (eg., the measurement of the cold loss of a traveling wave tube) over a wide range of frequencies. Such a measurement cannot be made with 1 milliwatt signal generator and a broadband detector as this type of system does not have the power levels nor the sensitivity to measure much more than 45 db insertion loss. Such a wideband measurement can be made quickly and easily with the use of one or two traveling wave tubes as amplifiers. Use of a traveling wave tube with a noise figure of 20 db ahead of the detector gives a sensitivity into a broadband detector of the order of -65 to -75 dbm. This alone allows the measurement of insertion loss of 65 to 75 db. Further, if the output of the signal generator is amplified to the power level of one watt (+ 30 dbm) by the use of a medium power traveling wave tube, the total insertion loss then measurable becomes 95 to 105 db. The only adjustment necessary as frequency is changed across the band is the tuning of the signal generator since the traveling wave tubes are broadband untuned devices. The insertion loss measurement can be made in the same manner as the insertion gain measurement shown in Figure 1 except for the addition of the amplifiers before and after the switches. Commercially available switches when connected as shown in Figure 1 have been measured to have a combined crosstalk ratio in excess of 120 db which, of course, eliminates any crosstalk error in insertion loss measurements in the range of 95 to 105 db.

## E. Measurement of Noise Figure

Where one is interested in measuring noise figure at a number of frequencies throughout a wide frequency band, the best method employs a fluorescent tube noise source and a superheterodyne receiver with a second detector which is square law (ie., a power detector). If noise figure does not vary too rapidly with frequency, a simple receiver can be used which employs only an untuned crystal mixer, a local oscillator, a 30 mc I.F. strip and a power detector. Note that no preselection or mixer tuning is used. Without a preselector, the receiver will respond equally well to the signal frequency and to the image frequency. With a 30 mc I.F. amplifier, these two frequencies will be only 60 mc apart, and if noise figure is not a rapid function of frequency then the measured noise figure will be an average of the true values at two frequencies 60 mc apart. This is accurate enough for most purposes. If noise figure varies so rapidly that it will be appreciably different at two frequencies spaced 60 mc, then preselection is necessary.

The noise figure of an amplifier is defined as the ratio of signal to noise ratio at the input of the amplifier to signal to noise ratio at the output of the amplifier.

$$\text{N.F.} = \frac{(S/N)_{\text{in}}}{(S/N)_{\text{out}}} \quad (\text{power ratio})$$

When the measurement is made according to the method outlined below, using a noise source whose level is 15.8 db above thermal noise, the above equation becomes:

$$\text{N.F.} = \frac{37k}{\frac{P_1}{P_2} - 1} \quad (\text{power ratio}) \quad (1)$$

where  $P_1$  and  $P_2$  are defined in the measurement procedure below.  $k$  is a number smaller than 1.0 which accounts for any cable loss between the noise source and the tube. It is the cable loss in db converted to a power ratio. (eg., for cable loss = 1 db,  $k = .794$ )

When a fluorescent noise source is used it is not necessary to know the effective RF noise bandwidth of the receiver.

### Procedure:

The tube to be measured is connected into the setup shown in Figure 3. The power detector in the receiver may take the form of a bolometer or a thermistor operating into a self balancing wattmeter bridge, or it may be a thermocouple whose output is connected to a microammeter.



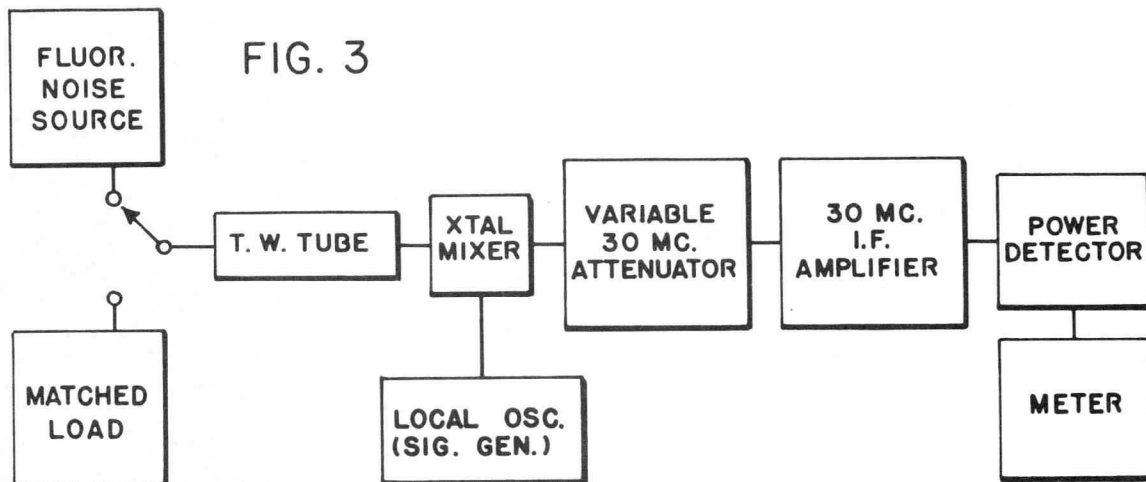

SET-UP FOR MEASURING NOISE FIGURE

1. With tube operating and local oscillator tuned to the desired frequency, switch tube input to the fluorescent noise source.

2. Adjust variable 30 mc attenuator until the reading on the output meter is approximately full scale. This is reading  $P_1$ .

3. Switch tube input to the matched load. The reading of the output meter is  $P_2$ .

4. Insert values for  $P_1$  and  $P_2$  in equation (1) for noise figure. Noise figure in db is obtained by merely converting this number to db.

Precautions:

The accuracy of this measurement is based upon the assumption that the receiver is linear. This will be true if the local oscillator signal is large enough to produce linear mixing and if the I.F. amplifier is operated in the linear portion of its characteristics.

The measurements should be taken quickly enough so that power meter drift will not effect readings.

-- L. A. Roberts

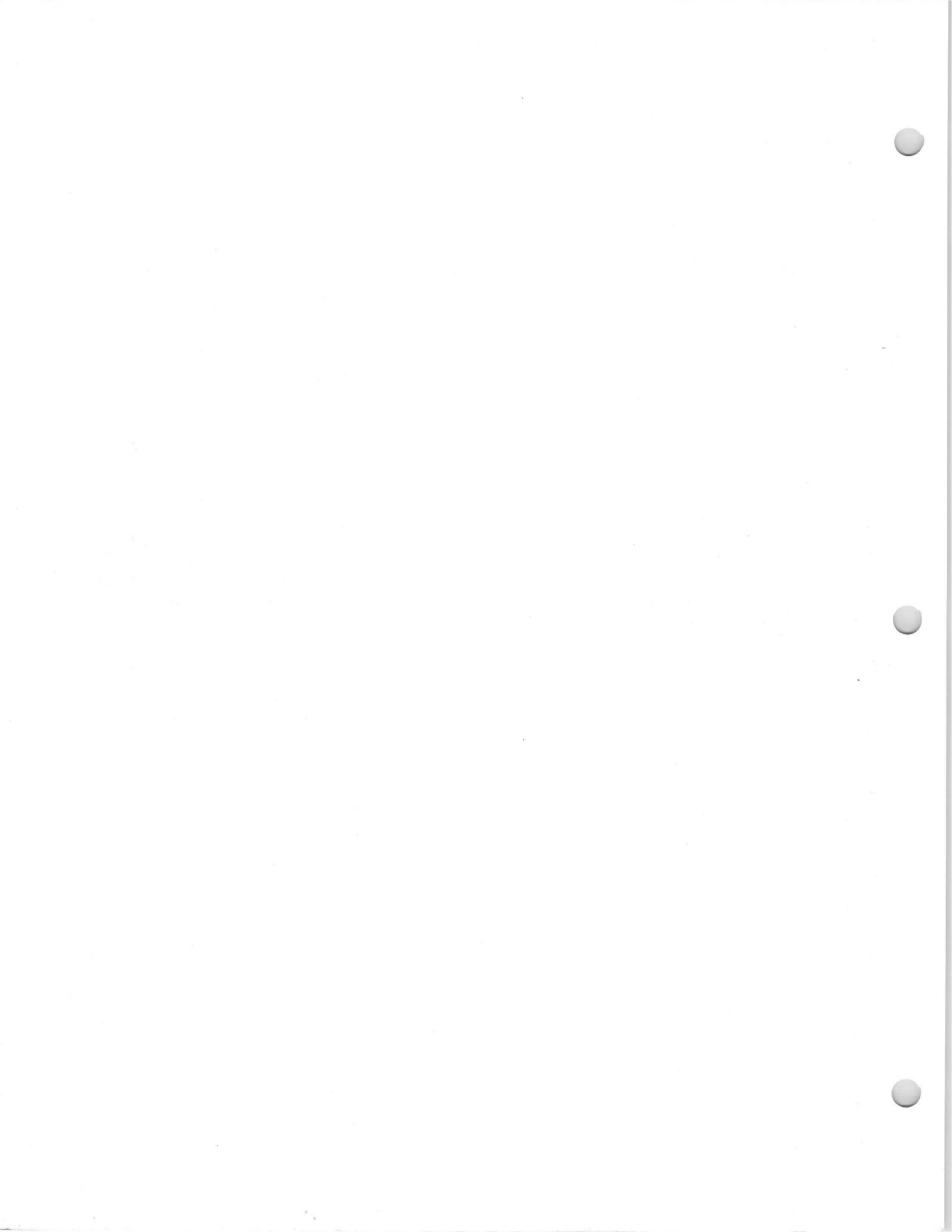



# HUGGINS LABORATORIES ENGINEERING NOTES

VOL. 1, NO. 2

JULY 1955

Published by Huggins Laboratories

Menlo Park, California

## DOMESTICATING THE TRAVELING WAVE TUBE\*

Peter D. Lacy\*\*

### Introduction

In a report<sup>1</sup> on the status of traveling wave tubes at the Symposium on Modern Advances in Microwave Techniques last November, Dr. Watkins of Stanford characterized traveling wave tubes as "the most advertised, least delivered tubes in electronics history". A major reason for this state of affairs has been their failure to find wide application in the electronics industry. The unique characteristic of TWT's, wide bandwidth, poses a difficult question: How can it be used? This requires careful study of the types of systems in which it will be useful and intensive development of new techniques for handling such bandwidths. Some possible directions that broadband systems may follow will be indicated later.

In this discussion of TWT's, no tubes that are new or that have improved characteristics will be considered since the new advances have been well covered elsewhere<sup>2</sup>. Rather, it is proposed to consider only the most ordinary of TWT's that are advertised and in commercial production now. The gain, relative bandwidth, power output and noise figure of these tubes do not differ substantially from the first tube described by Pierce and Field<sup>3</sup> in 1946. These are tubes with about 30 db of gain, octave frequency coverage through X band, noise figures of 20 to 30 db, and output power of 10 milliwatts to 1 watt.

This power range is well suited to the vital functions of modulation and detection so that microwave circuits may be linked with information handling video circuits. It is suitable for stable oscillator circuits comprised of either microwave oscillators or low frequency oscillators followed by a frequency multiplier chain. The level is quite suitable for most microwave measurements and some new measurement techniques become possible due to the characteristics of the TWT. The upper power limit is adequate for a large portion of the fixed path propagation links in microwave systems. After all, this is about the same power range in which most electronic tubes operate!

As to the broad frequency range of the TWT, one can either take it or leave it. If the application requires a broad bandwidth, then the TWT is without peer. On the other hand, if the application requires only a narrow bandwidth, the TWT may still be used at any point in the wide amplification band provided by the TWT. In such cases, it is often advisable to filter the output of the tube to reduce noise. The narrow band filter is in a passive transmission line for the TWT, as contrasted with the tuned circuits of klystron or space charge control tubes that are in contact with the tube electrodes. In the latter case, the amplification is quite sensitive to the tuned circuit parameters so the design and adjustments become critical.

---

\* Presented at Seventh Region IRE, Technical Conference, Phoenix, Arizona, April 28, 1955.

\*\* Hewlett-Packard Company  
Palo Alto, California



## New Frontiers

One of the new frontiers that may be opened up by the bandwidth of the TWT is the transformation of video techniques and functions to the microwave domain. This would mean increasing the effective bandwidth from the tens to hundreds of megacycles now available to thousands of megacycles. This practice would increase by one to two orders of magnitude the resolution or speed of basic physical measurements, electronic measurement, communication, and computation.

The first obstacle preventing such a transfer of video systems to microwaves is the lack of terminal devices, that is, how do we enter such a high speed electronic system and then retrieve the new or processes information? Next, the internal functions of the microwave system, which determine the breadth of application, will demand intensive development. Such problems will require considerable effort before very high speed microwave systems can be realized.

A.C. Beck<sup>4</sup> has recently demonstrated a millimicrosecond pulse system for locating waveguide faults. Another example of a very high resolution pulse echo system that could be achieved with present techniques where the resolution is determined mainly by the center rf frequency will be given. In this system a fast pulse and low phase distortion are also needed. Figure 1 is a block diagram of this type of system. The rf pulse generator, in which the rf carrier is phase locked to the repetition rate, may be of the regenerative type like Cutler's<sup>5</sup> if the phase precession can be eliminated or a beam deflection tube pulser<sup>6</sup> with a frequency multiplier and amplifier driven by the pulse repetition rate frequency and a modulator. The delayed rf pulse from the generator and the return pulse are fed into a microwave coincidence circuit which consists of a hybrid tee and a pair of crystal detectors with balanced reversed crystals. The microwave coincidence circuit shown in Figure 1 operates as follows:

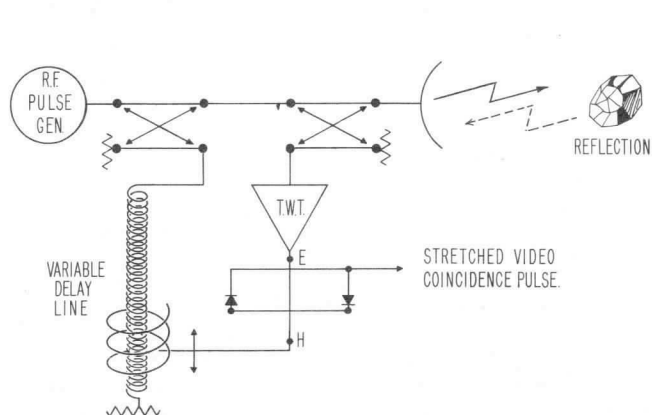

PRECISION REFLECTION LOCATION

Figure 1

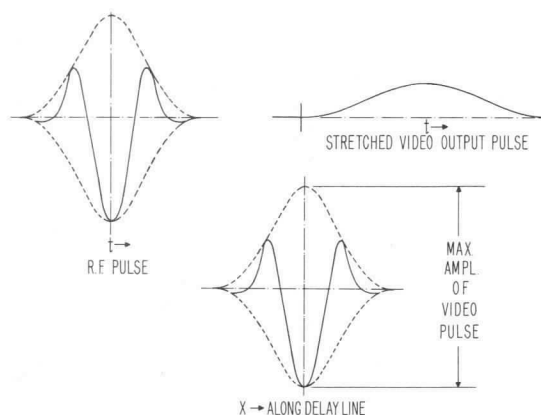

PRECISION REFLECTION LOCATION WAVEFORMS

Figure 2

for an input in the E arm, the two crystals conduct during the same half cycle with equal outputs and opposite polarity. For an input in the H arm, one crystal conducts one half cycle and the other crystal in the second half cycle. Again over one complete cycle the average output is zero. For simultaneous inputs to the E and H arms and proper rf phases, the non-linearity of the crystal detectors cause a net output. When the crystals operate square law, the coincidence circuit shown is a cross-correlation detector. Figure 2 shows the resulting waveforms with the rf carrier phase stationary in the pulse. The accuracy of locating a minimum near the center of the pulse should be a fraction of an rf cycle, say 10 degrees, so for a carrier of 3,000 mc a spatial resolution of about 1/10 inch could be expected. This is only an elementary example of a high performance system utilizing the bandwidths available from TWT's. This system could also be used in particle emission coincidence studies with an accuracy determined there by the pulse width.

It would be difficult to estimate the ultimate extent of TWT usage in the expanding electronics field. However, it does appear to be a fruitful field for exploration and invention. With the increasing dependence on electronics in industry and science today, certainly there shall develop a demand for greatly increased speed in electronic detection, processing, and control and the TWT is orders of magnitude ahead of any other electronic device.

### Modulation Characteristics

Now turning from the broad bandwidth feature, let us consider some more down to earth characteristics. A number of functions may be performed by modulating the TWT electrodes. The two variables are the beam current and beam velocity. The beam current may be varied by means of the potentials applied to one of the electrodes of the electron gun. A typical variation of the rf output voltage and its phase with electrode voltage is shown in Figure 3. The tube output can be amplitude modulated over the linear portion (about 10 db) but the attendant phase modulation is about 90 degrees. The amplitude modulation still can be useful where amplitude detection only is involved in demodulation.

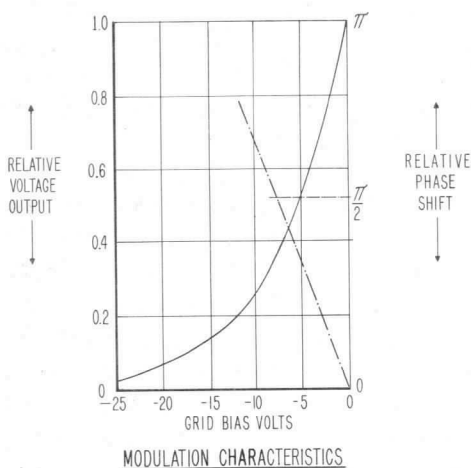
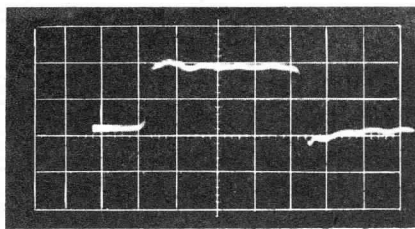
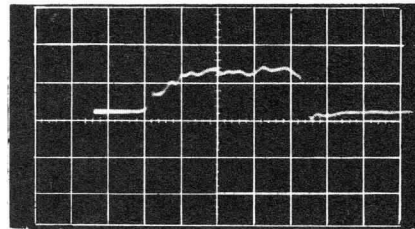

Figure 3

The effect of pulse modulation is shown in Figure 4 for various conditions of tube drive and pulse off-on ratio. In the top oscillogram, the tube is driven to saturation with an off-on ratio of 40 db. The modulating pulse had a rise time of about one millimicrosecond and an amplitude of 40 volts. The resulting rise time is 4 millimicroseconds which was close to the oscilloscope amplifier rise time. In the middle picture, the off-on ration is still 40 db but the tube is operating well below saturation. It seems that the entrance of the pulsed beam into the helix induces a voltage on the helix that in turn changes the beam velocity. When the electron beam wave velocity is shifted away



← (a)  
PEAK T.W.T. OUTPUT.  
40 DB OFF-ON RATIO.



(b) →  
LOW T.W.T. OUTPUT.  
40 DB OFF-ON RATIO.

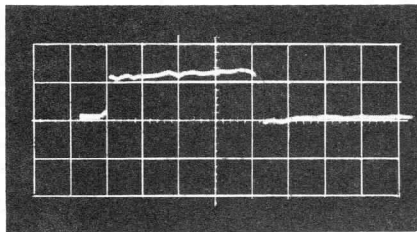

← (c)  
LOW T.W.T. OUTPUT  
18 DB OFF-ON RATIO.

10 MW, 2-4 K MC T.W.T. DETECTED PULSE OSCILLOGRAMS  
(SWEEP 20 M $\mu$  SEC DIV.)

Figure 4

from the helix wave velocity the TWT amplification decreases. Thus a transient period of reduced amplification occurs at the start of the pulse slowing the rise time to about 20 millimicroseconds. In the lower picture the off-on ratio has been reduced to 18 db by reducing the bias and pulse amplitude to about 15 volts so with this lower current ratio the rise time is good again. It can be seen from these pulse oscillograms that under proper conditions, the TWT may be used for generating low level pulses for testing the receiver portions of systems having fast rise time pulses in the transmitter.

In Figure 5, an amplitude modulated pulse train is shown. This was generated by applying a pulse and sine wave to the TWT grid. By this method, lobing or incidental flutter may be simulated in system testing.

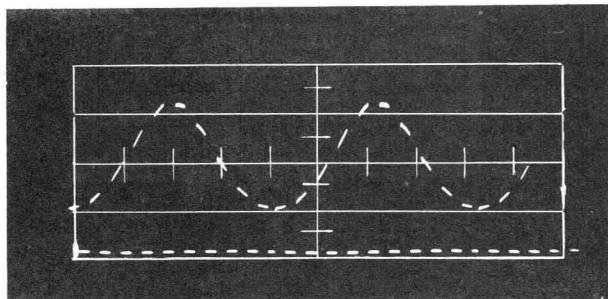

AMPLITUDE MODULATED  
PULSE TRAIN

Figure 6 shows the effect of varying the helix or beam voltage on the phase of the output of a TWT amplifier. For constant beam current (solid curve) the phase change versus helix voltage is nearly linear. However, the output levels vary, being maximum at some optimum helix voltage and diminishing on either side. The amplitude may be held constant by an amplitude stabilization signal that is fed back to the grid of the electron gun. The resulting phase curve (dotted) is shown. It is not linear but the advantages of eliminating amplitude variations may outweigh the effect of this phase characteristic distortion.

Figure 5



The amplitude and phase characteristics of TWT's have been presented and the interaction of the two effects due to grid or helix voltage variation. The amplitude modulation characteristics shown are similar to those found in any other amplifier tube, however, the large amount of phase modulation possible (over 360 degrees) can produce some interesting results.

### Sawtooth Phase Modulation

Mr. Ray Cummings<sup>7</sup> of Stanford University has devised a method of approximating phase modulation of unlimited deviation by its stepwise discontinuous equivalent. Consider a uniform phase change, constantly increasing, for instance, it may be approximated as shown in Figure 7 by increasing the phase constantly over a full rf cycle of  $2\pi$  radians of phase and then quickly jumping back to the starting phase and then commencing to advance again at the previous constant rate. This is a stepwise discontinuous approximation to the continuous

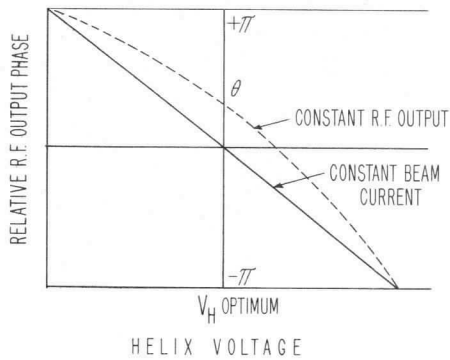

T.W.T. PHASE CHARACTERISTIC

Figure 6

phase advance associated with the doppler shift of approaching source. Since one cycle of rf has been added during a period  $\tau$ , the shift in frequency is just  $1/\tau$ .

Figure 8 shows oscillograms of the helix modulation voltage and the mixed product of the original signal and the frequency shifted output signal. Note the switching transient due to the finite flyback time of the sawtooth wave. This flyback time can be reduced considerably and thereby correspondingly reduce the error in doppler simulation. This system becomes a very accurate 2 terminal pair

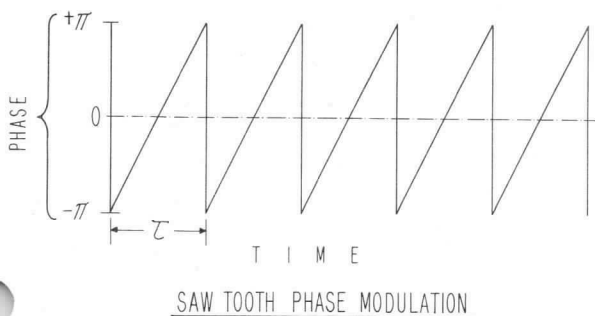

SAW TOOTH PHASE MODULATION

Figure 7

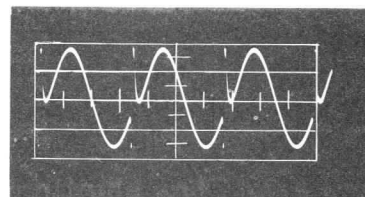

HOMODYNE MIXER OUTPUT

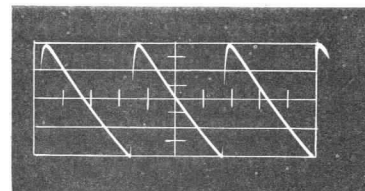

1 KC SAWTOOTH FOR HELIX MODULATION

### SINGLE SIDEBAND MODULATION

Figure 8

EN / 12 / 7-1-55

device for simulating doppler shifts from a few cycles per second to about a hundred kilocycles. This should provide a very satisfactory instrument for the design and test of cw doppler and coherent pulse radars.

### Linear Detection In Microwave Measurements

Another powerful application of frequency offset or single side band modulation is the use of linear or homodyne detection which greatly extended the dynamic range of microwave measurements. Figure 9 shows a homodyne measurement system.

The TWT provides a frequency offset  $f_1$ . This shifted frequency is then applied to the system under test that yields a weak output signal. The weak signal and the strong reference signal or local oscillator are then applied to a crystal mixer. The mixer is operated linearly and the beat frequency  $f_1$ , 1 kc possibly, is then applied to a tuned amplifier and meter such as a VSWR detector. Linear mixer output ranges approaching 100 db may be attained compared with an equivalent 50 db range for a square law detector. Thus the sensitivity and dynamic range for measurements is increased by a power ratio of about 10 billion.

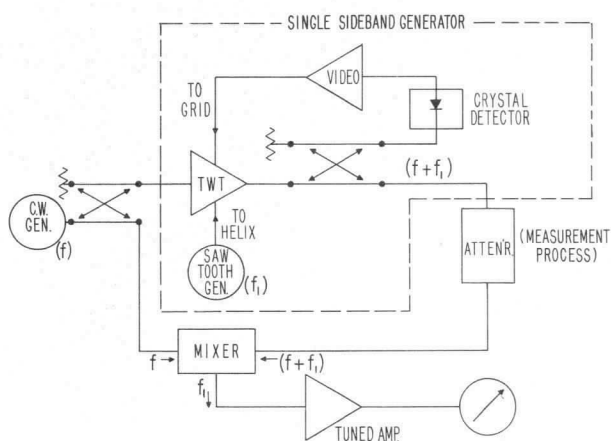

LINEAR (HOMODYNE) DETECTION SYSTEM FOR MICROWAVE MEASUREMENT.

Figure 9

recommended 2:1 bandwidth.

3) gain is provided in the weak signal channel.

Of the possible alternatives, rotating mechanical or ferrite phase shifters and other types of tubes, no one device has all three of the listed advantages.

### General Applications

A still further type of modulation available with the TWT is suppressed carrier modulation. Figure 10 shows the required modulations for the control grid and helix and the resulting suppressed carrier rf output. In comparison with a magic tee and crystal balanced modulator, in this one all adjustments are voltages rather than mechanical positions and the TWT modulation characteristics may offer a greater degree of stability than balanced microwave crystals.

For narrowband work, the noise level due to the immense bandwidth of the TWT is often objectionable. The residual noise level and the effective dynamic range (noise to saturation level) may be greatly improved by inserting a band pass filter

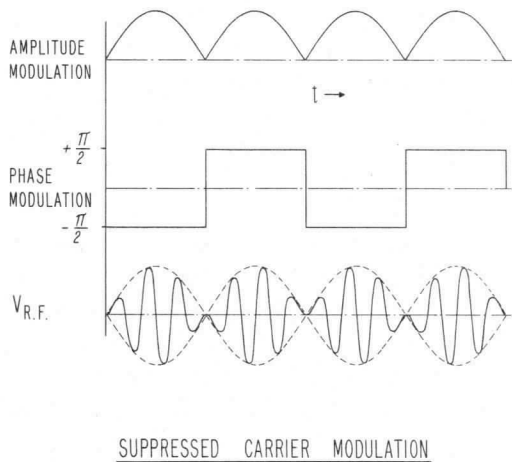

Figure 10

by a high Q reference cavity, the TWT uses the high Q cavity directly in the feedback circuit of the oscillator to control the instantaneous frequency.

Many other applications of TWT's are possible, since the fundamental component of any electronic system is the signal amplifier. In the role of amplifier, the TWT is rapidly opening up wide regions of the microwave spectrum to a much more flexible approach to system synthesis.

#### Coupled Helix Circuits

Another more speculative role for the TWT lies in the use of helically coupled circuits on the outside of the vacuum envelope. Figure 11 shows a tube with its amplifier circuit in place. The role of the vacuum tube is reduced to an active transmission line in one direction and a passive line in the other direction. Input and output couplers may be arranged along the tube at will, attenuating sections are applied to eliminate any return signal from output to input in the passive backward direction. These are the usual amplifier functions connected with making a stable amplifier tube. Variation of the tube length may be used to adjust the amplifier delay time which might open up the use of the tube for fast switching functions. External reactive and resistive circuit elements can change the frequency response as well as the non-linear characteristics of the active line. Some work has started along these lines; however, there is no estimate yet as to how far or how flexible these external circuitry methods are.

The immediate advantage of external circuitry has been that the internal vacuum tube has been reduced to its simplest form. An electron gun, a uniform helix, and a beam collector. The critical circuit functions of coupling in and out of the tube and stabilizing the amplifier are now made separate and may be adjusted. This can mean a substantial increase in production yield.

after the TWT. Under this condition the TWT should then be competitive with either a klystron or triode amplifier as far as dynamic range and gain are concerned, but since a few different TWT types can be adapted to this use anywhere in the microwave range up to 12 KMC, just three or four different tube types could do the job and require only the addition of a single bandpass filter in the output transmission line. The TWT does have greater time delay than its competitors and often the phase distortion has been excessive. The phase distortion is being constantly improved and with the coupled helix circuit on the outside of a tube with excellent internal phase characteristics, the phase distortion can be reduced even further with care in constructing the external microwave circuit.

TWT's have been proven excellent as highly stable microwave oscillators. Hetland and Buss<sup>8</sup> of Stanford University have computed noise bandwidths of as low as  $10^{-3}$  cps at 3 KMC. As compared with a stabilized reflex klystron, in which a tube with a relatively low Q oscillator cavity has its mean frequency corrected



The precision machine work required on the capsule has been reduced to a minimum. The coupling helices and the mounting hole require precision while the rest of the manufacturing operations can be simple fabrication methods like sawcuts, stamping, and rolling. Thus with the versatility afforded by the wide bandwidth which also reduces the number of tube types, in conjunction with high yield manufacturing methods, sufficient demand may be expected to result in low cost-flexible microwave amplification by the TWT.

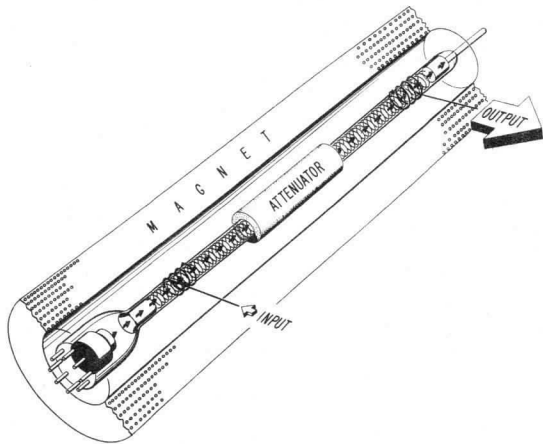

Figure 11

### Conclusions

The traveling wave tube and other related distributed circuit-electron beam interaction tubes have been the object of intensive research and invention for nearly ten years; however, only in the past year have tubes of a general purpose nature become commercially available. Now it becomes necessary to critically examine the range of usefulness of the TWT. The use of the broadband property will require another research phase before it can be judged and given suitable employment. A broader less critical role can be filled by just a few types of tubes providing narrow band amplification and useful modulation characteristics through most of the microwave range.

It is hoped the modulation characteristics and possible applications presented here may suggest some useful tasks for the TWT.

### Acknowledgements

The author is indebted to Mr. Ray Cummings of Stanford University for the method of generating a frequency off-set with the TWT and to D.E. Wheeler, G.W. Mathers, and H.C. Poulter of the Hewlett-Packard Company for many contributions and discussions during the preparation of this paper.

### Editor's Note

This laboratory is very pleased for the privilege of publishing the forgoing paper by Dr. Lacy. We would be equally pleased to receive similar papers or reports that deal with your experiences and findings on the characteristics and applications of traveling wave tubes. The traveling wave tube is still a new microwave component whose use would be greatly facilitated by such a mutual exchange of information.

## References

- 1 Traveling-Wave Tubes and Backward-Wave Tubes, D. A. Watkins, Symposium on Modern Advances in Microwave Techniques, New York City, November 8, 1954.
- 2 Some Recent Advances in Microwave Tubes, Proc. IRE, Vol. 42, p. 1735, December 1954.
- 3 Traveling-Wave Tubes, J. R. Pierce and L. M. Field, Proc. IRE, Vol. 35, p. 108, February 1947.
- 4 Microwave Testing with Millimicrosecond Pulses, A. C. Beck, Trans, IRE, P.G.M.T.T., Vol. MTT-2, No. 1, p. 93, April 1954.
- 5 The Regenerative Pulse Generator, C. C. Cutler, Proc. IRE, Vol. 43, p. 140, February 1955.
- 6 The Type 6218 Beam Deflection Tube as a Complex Pulse Generator, Rev. Sci. Instr., Vol. 25, p. 355, April 1954.
- 7 Frequency Translation by Modulation of Klystrons and Traveling-Wave Tubes, Ray Cummings, Report No. 39, Electronics Research Laboratory, Stanford University.
- 8 Microwave Oscillator Stability, G. Hetland, Jr. and R. R. Buss, Trans. IRE, PGED, April 1954.

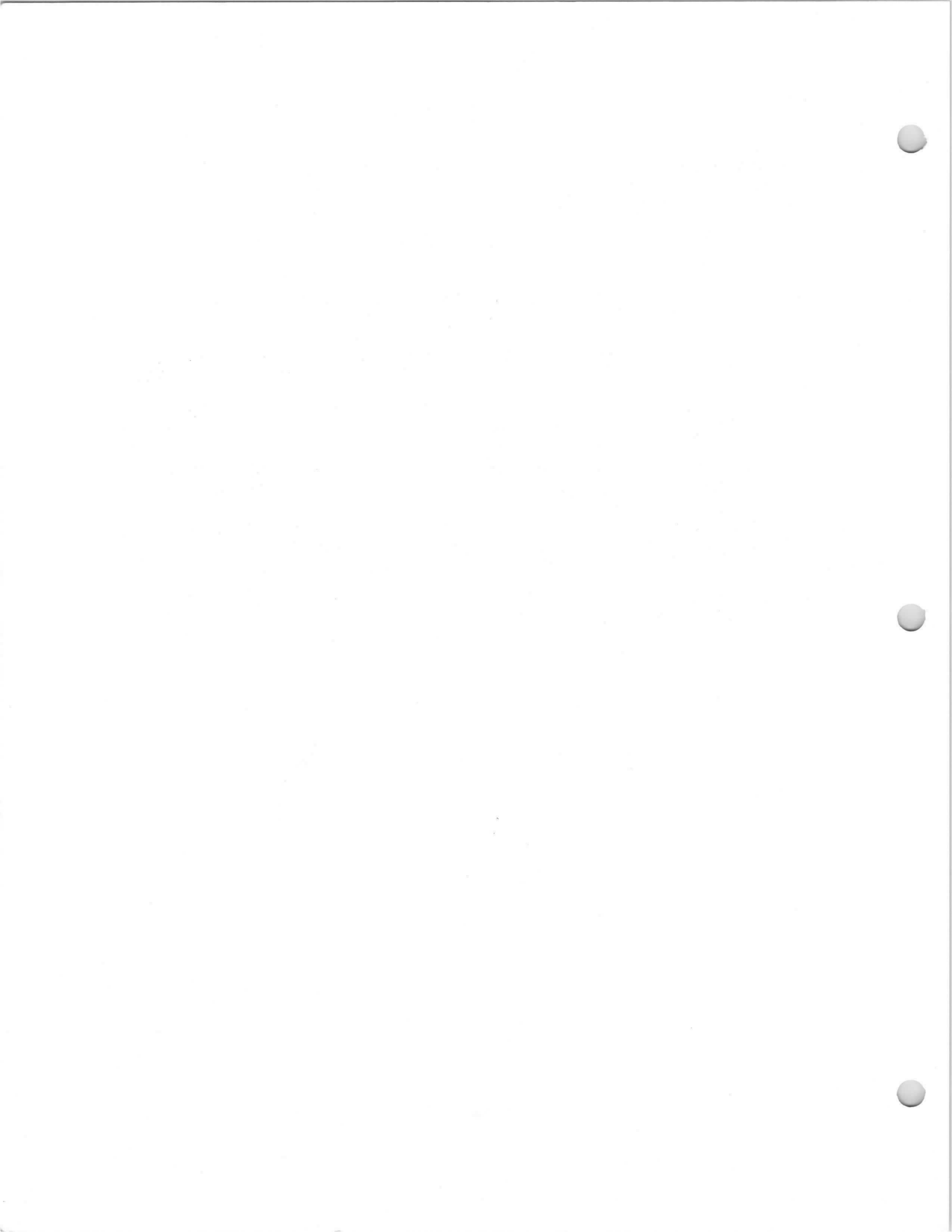





# HUGGINS LABORATORIES ENGINEERING NOTES

VOL. I, NO. 3

AUGUST 1955

Published by Huggins Laboratories

Menlo Park, California

## AN X-BAND BACKWARD-WAVE OSCILLATOR\*

W. V. Christensen\*\*

### Introduction

It is possible to build a backward-wave oscillator with a number of different rf interaction structures. Some examples of these include loaded waveguide, interdigital lines, folded lines, helices, and variations of all of these. The one feature that all of these structures have in common is a spatial periodicity along the tube in the direction in which the electron beam flows. The particular choice of circuit may depend on several factors, such as power output required, ease of construction, shape of tuning curve required, tuning bandwidth, and frequency of operation.

For the tube under present discussion, a single-filar helix was chosen. In the X-band, the helix is of reasonable dimensions and the techniques of building all glass helix type traveling-wave tubes were familiar to us. The helix type tube also leads to a small and relatively simple tube and package.

### Performance Requirements

The single-filar helix type tube is capable of operating over a 2:1 frequency range. The designed frequency range for the tube was then chosen to cover the 7.0 to 14.0 Kmc band which puts the most uniform region of power output in the X-band (8.2 to 12.4 Kmc). The design goal for power output was nominally set at 100 mw across the X-band and it was hoped that the power output would not drop too drastically outside of this band.

### Physical Requirements

To cover the 2:1 frequency range, it is necessary to couple the rf power out of the tube with a coaxial system. Fortunately, the characteristic impedance of the helix is near 50 ohms and the coaxial line can be connected directly to the helix with a VSWR of less than 2:1. With a coaxial rf output, the cable can be placed parallel to the axis of the tube and brought out of the end

---

\* Presented at 1955 Electronic Components Conference,  
Los Angeles, California, May 26-27, 1955.

\*\* Huggins Laboratories  
Menlo Park, California

of the capsule. This requires the capsule diameter to be only large enough to fit around the gun bulb which is the largest diameter on the tube. The outside capsule diameter could then be held to 1.0 inch.

The magnetic field required to focus such a tube is of the order of 1000 gauss. To supply this value of field it is necessary to build an air-cooled solenoid. The solenoid can be built with open windings in such a way that forced air comes in contact with each layer. This forms an efficient solenoid cooling scheme. Air from the same blower which cools the solenoid can be used to cool the tube by merely passing the air over the outside of the capsule, for the tube elements which need cooling are placed in good thermal contact with the capsule itself.

### Construction Techniques

The fields of the backward-wave mode on a helix are associated very closely to the helix wires themselves. Since these fields fall off very rapidly in a radial direction away from the helix, it is necessary to have all of the interacting electrons in the beam pass very close to the helix. This results in the requirement for a hollow beam of very tight dimensional tolerances whose thickness and spacing from the helix is only a few thousandths of an inch. To enhance the backward-wave mode, the helix is wound from tape whose width is about four times its thickness. The dielectric loading of the helix by the surrounding glass envelope is kept low by supporting the helix in a fluted glass envelope. Thus, glass touches the helix only along three line contacts.

The electron beam is formed in a hollow beam gun which has a cathode just the shape of the beam cross-section. The gun is a parallel flow Pierce type. The cathode is a Philips impregnated cathode which can easily support the required current density of 0.6 ampere/cm<sup>2</sup>.

### Physical Description

The tube is enclosed in a capsule one inch in diameter and eleven inches long. This is shown in Figure 1. A flexible cable with the dc leads is brought out of the gun end of the capsule.

The rf output cable is a flexible coax line with teflon dielectric. The cable is terminated either in a special type N coaxial connector which has low residual VSWR up to 14.0 Kmc or terminated in an X-band waveguide adapter where only the X-band is required.

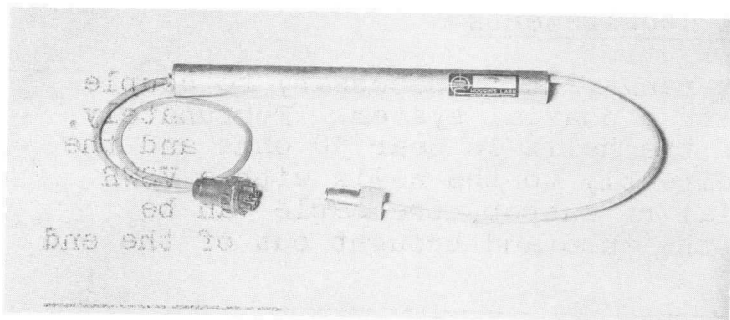

Backward-Wave Oscillator

Figure 1

The tube fits into the solenoid which is  $4\frac{1}{4} \times 4\frac{1}{4}$  inches in cross-section. The blower which cools both the tube and solenoid is mounted at one end of the solenoid and is contained within the solenoid case. The overall length of the unit including solenoid and blower is  $16\frac{1}{2}$  inches.

### Tube Performance

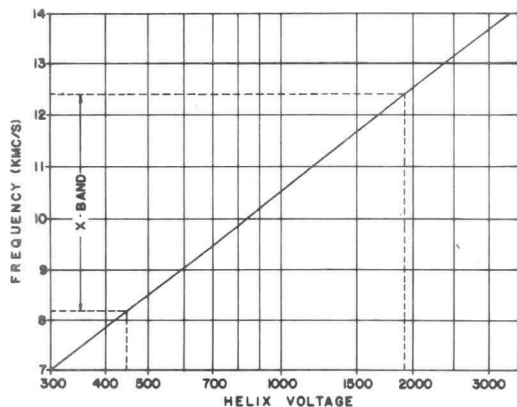

### Tuning Curve

Figure 2

### Tuning Curve

Figure 2 shows a curve of frequency vs. helix voltage. When plotted on semi-log coordinates in this fashion, the curve becomes a straight line. This is typical of most backward-wave oscillator structures. To cover the full 7.0 to 14.0 Kmc frequency range, the helix voltage must vary from 300 to 3300 volts. For operation over just X-band, the maximum helix voltage required is considerably reduced. X-band is covered by the voltage range of 450 to 1900 volts.

### Power Output

The curve of power output vs. frequency is shown in Figure 3. Across the X-band the power output is greater than 14 dbm. The minimum power within the 7.0 to 14.0 Kmc band is 4.0 dbm.

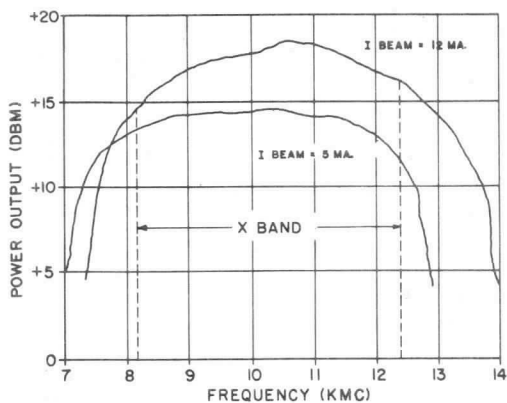

### Power Curve

Figure 3

### Spurious Responses

The tube has been tested for spurious responses across the band under various load conditions. With a load having a VSWR of 3:1 or less, no spurious responses were observed 90 db below signal level. With a load having a VSWR greater than 3:1, frequency discontinuities were noted across the band and spurious frequencies suddenly appeared in the neighborhood of 12.9 Kmc. Thus, for extreme VSWR variations of the load, a 3 db pad in series with the output cable will insure satisfactory operation even for open or short circuit loads.

### Power Supply Requirements

#### Power Requirements for the Tube

Figure 4 shows a schematic diagram of the tube, power supplies, and metering required. The anode supply must be variable and

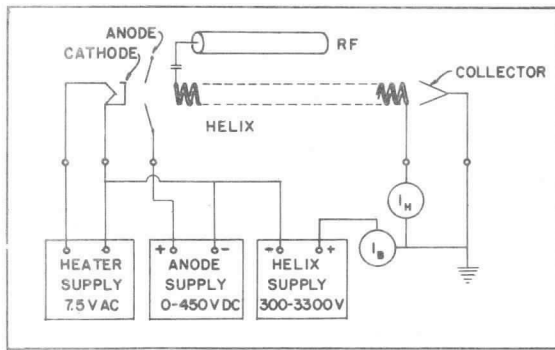

Power Supply

Figure 4

deliver between 300 and 450 volts at 1.0 ma. Both the anode supply and the 7.5 volt ac heater supply must be insulated from ground for the full helix to cathode voltage. The helix and collector electrodes are operated at ground potential, and tuning is obtained by operating the cathode negative with respect to the helix. The helix and collector supply must be variable from 300 to 3300 volts and capable of delivering 13 ma.

The tube requires a 1000 gauss magnetic field to properly focus the beam over the entire frequency range. If only X-band is required, then the magnetic field need be only 750 gauss. For the 1000 gauss field, the solenoid requires 90 volts at 4.1 amps. The blower requires 28 volts at 2.5 amps.

Power Supply Stability and Ripple Requirements

The regulation and filtering of the various power supplies is dependent upon the frequency stability required since all of the voltages affect the frequency in some way. Figure 5 shows the slope of the tuning curve as a function of helix voltage. The large number of Mc/s/volt gives an idea of the stability of the helix voltage required to maintain a fixed frequency. For example, at 2000 volts the slope is 1.4 Mc/volt. A peak to peak ripple of 0.1% in helix voltage would result in a variation in frequency of plus or minus 1.4 Mc. A ripple of 0.1% of any helix voltage in the operating range will result in the same frequency deviation of plus or minus 1.4 Mc because of the logarithmic variation in the slope.

The anode voltage controls the beam current which has a small effect on frequency. Figure 6 shows the relationship between anode voltage and this frequency shift. As the anode voltage is increased

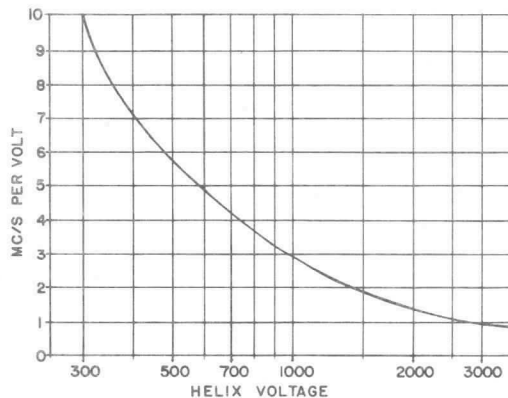

Tuning Curve Slope

Figure 5

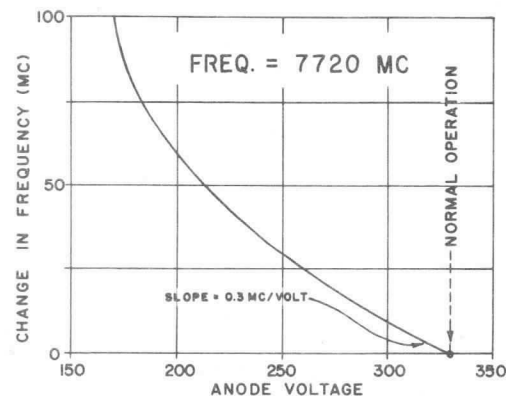

Anode Voltage Frequency Shift

Figure 6



the frequency decreases. The slope of this increase is 0.3 Mc/volt at the normal operating current of 12 ma. A peak to peak ripple of 1% on the anode voltage will result in a frequency variation of plus or minus 500 Kc.

The magnetic flux density of the solenoid affects the shape of the electron beam as well as the amount of intercepted current on the various electrodes. Both of these factors affect frequency.

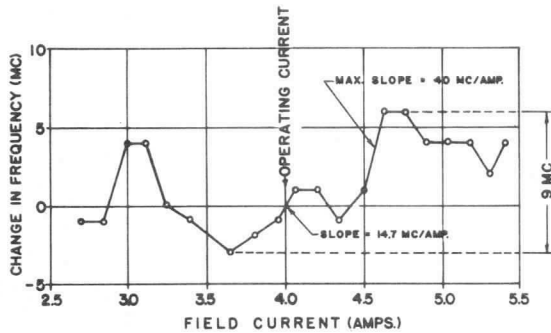

Field Current Frequency Shift

Figure 7

Thus, frequency is somewhat a function of the current through the solenoid. Figure 7 shows shift in frequency vs. solenoid current. The slope of this curve at the operating point is 14.7 Mc/amp. A peak to peak ripple current in the solenoid of 1% would lead to a frequency variation of plus or minus 300 Kc. The maximum deviation was 9 Mc, and the maximum slope observed was 40 Mc/amp. The fine details of this curve will probably vary from tube to tube.

#### Future Trends

The future trend in backward-wave oscillator design will be toward permanent magnet focusing and lower operating voltages. The lower operating voltages will result in a greater slope in the tuning curve and thus more Mcs/volt. The permanent magnet focusing will eliminate the need for the solenoid as well as the need for the blower to cool it and the associated power supplies.

#### Tubes Under Development

At the present time, tubes are under development in the frequency ranges of 2.0 to 4.0 Kmc, 3.75 to 7.5 Kmc, and 10 to 20 Kmc. The power output levels of these tubes range from 50 to 500 milliwatts in the lower frequency ranges, to 10 to 15 milliwatts in the highest frequency range.

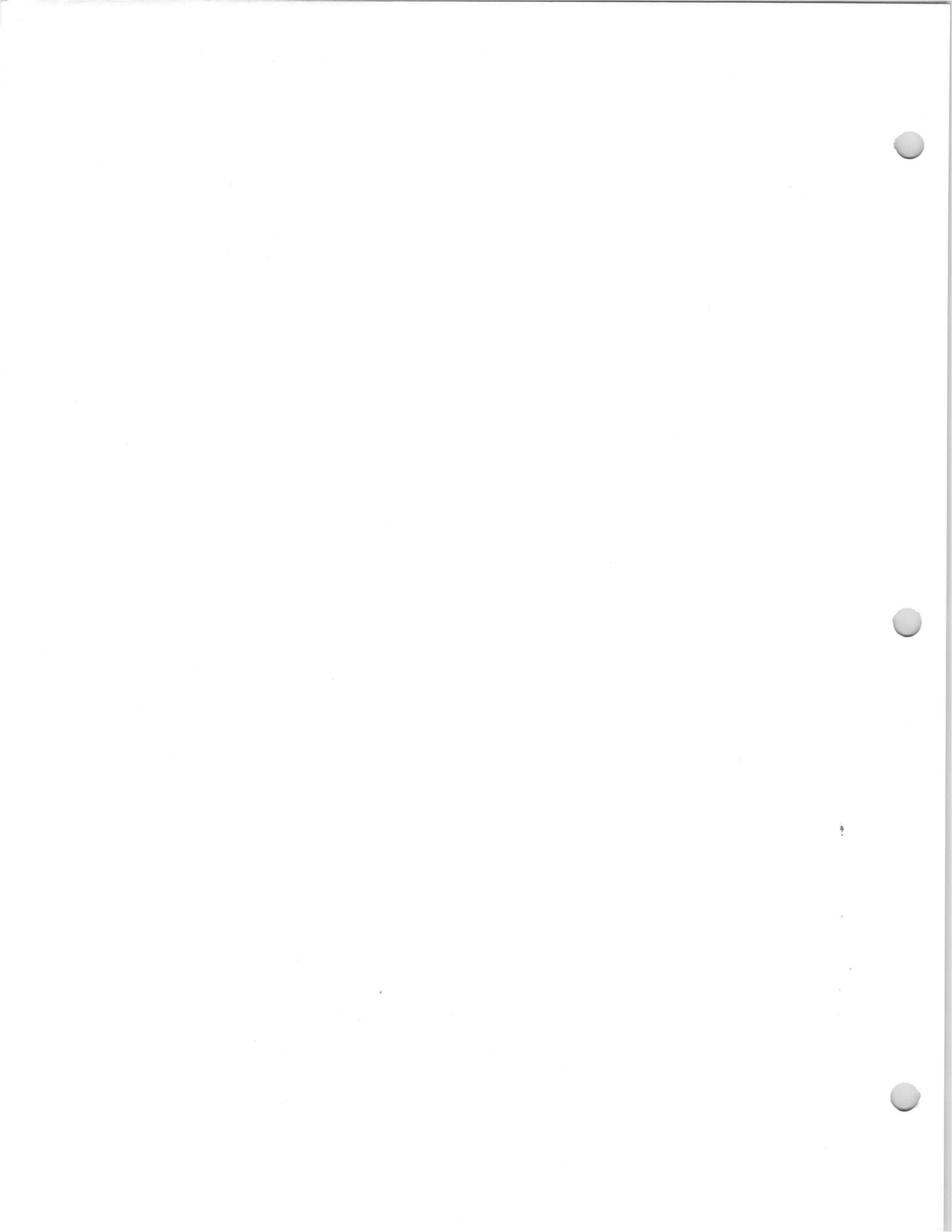

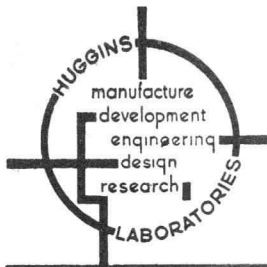

# HUGGINS LABORATORIES ENGINEERING NOTES

VOL. I, NO. 4

OCTOBER 1955

Published by Huggins Laboratories

Menlo Park, California

## AN X-BAND TRAVELING-WAVE AMPLIFIER\*

L. A. Roberts\*\*

### Introduction

As wideband systems and broadband measurement techniques have been developed, the traveling-wave tube has been found to be an extremely useful component. In the case of the forward-wave amplifier, its broadband untuned amplification characteristics and fast modulation properties make many systems and techniques possible which were previously difficult or even impossible to accomplish.

One of the most widely used microwave frequency ranges is the X-band (8.2 to 12.4 Kmc). Until the announcement of the tube to be described in this paper, there has been no commercially available general purpose traveling-wave tube amplifier in this range. The tube described herein provides useful operation over an octave frequency range which brackets the X-band.

### Performance Requirements

In designing this tube, it was desired to use as much of the inherent broadband properties of the traveling-wave tube as possible. Experience in lower frequency tubes has shown that they exhibit their most uniform characteristics over a 2:1 frequency range, even though they can provide useful gain well outside this range. The design goal was then set to cover a 2:1 frequency range which centered the region of best operation of the tube in the X-band.

The design goals of the tube were as follows:

Frequency Range: 7.0 to 14.0 Kmc

Gain: 30 db minimum at a  
fixed helix voltage

Power Output: 10 milliwatts minimum

Magnetic Field: 300 to 400 gauss

\* Presented at 1955 Electronic Components Conference,  
Los Angeles, California, May 26-27, 1955.

\*\* Huggins Laboratories  
Menlo Park, California

Stability: The tube must not oscillate with the following conditions applied simulataneously:

(1) Total reflections of any phase connected simultaneously to the input and the output, with (2) the helix at any voltage within 200 volts of synchronism and with (3) the beam current greater than the normal operating value.

Further, the initial adjustments to set the tube into operation must be simple. There should be no mechanical adjustments to the tube other than a simple alignment in the magnetic field to optimize the electron beam transmission through the tube.

### Physical Requirements

It was desired to have a small convection-cooled focusing solenoid which would require no external fans or blowers to cool the solenoid or tube. To accomplish this, the inside hole diameter of the solenoid has been kept as small as possible to hold solenoid power dissipation and temperature rise to a minimum. The solenoid inside diameter is determined by the diameter of the capsule in which the tube is mounted. The capsule size is in turn determined by the size of the gun bulb which results in a capsule one inch in diameter.

With this restriction on capsule diameter, the transmission lines to the tube input and output are of necessity coaxial lines. This is most easily accomplished by using flexible coaxial cable. The cable connectors required are type N. Where operation of the tube directly into X-band waveguide is desired, direct adapters from the cable to waveguide can be used in place of the type N connectors.

### Construction Techniques

#### A. General

The helix is supported in a tight fitting thin wall glass envelope. This envelope also serves as the vacuum envelope of the tube. The rf energy is introduced onto and removed from the helix of the tube by means of helical directional couplers which are external to the vacuum envelope. This type of coupling has become known as the "coupled-helix match." Such a coupler is a very wide-band device and almost complete transfer of energy from outer to inner helix can be accomplished over a 2:1 frequency range. The use of the coupled helix match leads to extremely simple construction of the tube. Within the vacuum envelope there is nothing except the electron gun, a uniform helix, and the collector electrode.

#### B. The Coupled Helix Match

The coupled helix match is a co-directional coupler. This means that the power flow in the inner and outer helix is in the



same direction. In order to accomplish this, it is necessary that the coupling helix be wound in the opposite sense to the inner or amplifying helix of the tube. Further, it is necessary that the phase velocity of the inner and outer helix be matched as closely as possible and that the correct length of the coupling helix be chosen to give the best power transfer characteristic across the band.

The input and output coupling helices are mounted within outer conductors and the spacing and the dielectric loading between helix and outer conductor is so arranged that the helix has a 50 ohm impedance. This then can be connected directly to the 50 ohm coaxial cable with a resulting low VSWR transition if care is taken to keep the resulting discontinuities small. The VSWR measured in the coaxial line due to the transition to the coupled helix and its coupling to the tube is nominally no greater than 1.7:1. With care, it can be made 1.4:1 or less.

### C. Attenuator

The center attenuation on the tube which is necessary to keep it from oscillating is introduced also by a coupled helix technique. This section of helix, which is also external to the vacuum envelope, is actually a lossy directional coupler which dissipates the energy which is coupled into it. The coupled helix attenuator has several advantages. (1) The actual application of the attenuation to the tube does not take place until the construction and pumping are complete and the tube is ready for test. This means that the attenuator can be checked out on an operating tube. If the attenuator is not exactly correct, the change can be made simply and the tube does not have to be torn apart to make the change as is the case where the loss is within the vacuum envelope. (2) Coupled helix attenuation is an extremely wideband scheme. It can couple in loss which is sufficient to prevent oscillation over the entire range where the tube exhibits any net gain. (3) The reflection coefficient seen from the helix looking into the attenuator section is also extremely low. This property makes short circuit stability possible and keeps gain fluctuations due to regenerative feedback at a very low level.

### D. The Electron Gun

The electron gun is a parallel flow Pierce type gun. The current density required in the beam is 0.5 ampere per square centimeter. This value of current density is easily obtained from a Philips impregnated cathode. This type of cathode has the further advantage of being reliable and easy to process.

### E. General Construction Philosophy

To sum up the philosophy of the construction techniques on this tube: (1) Only the minimum number of parts are inside the vacuum envelope thus making the tube itself simple to construct. (2) All coupling and loss is accomplished with components external to the vacuum envelope so that adjustments and changes can be made on an operating tube under test.

## Physical Description

Figure 1 is a photograph of the encapsulated tube. The capsule is one inch in diameter and 13 inches long. The dc leads are brought into the capsule through the gun end with a flexible cable which is fitted with a high voltage connector. The rf cables are double braided flexible coax with teflon dielectric (RG-142/U). The rf connectors are special type N female which introduce only a small reflection up to 14.0 Kmc. The capsule fits into a solenoid whose outside dimensions are 3-3/8" x 3-3/8" x 12". This solenoid provides 400 gauss with 60 watts dissipation.

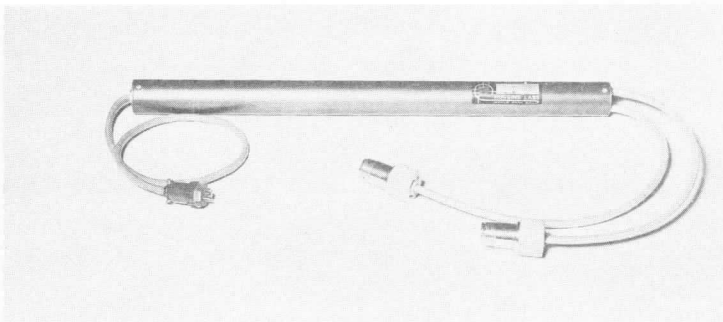

Encapsulated HA-4 Traveling-Wave Tube

Figure 1

The tube is operated with the collector at ground and connected to the capsule. The cathode and anode are operated negative with respect to ground. In this way there are no exposed electrodes or leads which have a potential with respect to ground. This prevents any hazard to operating personnel.

## Tube Performance

### A. Gain and Power Output

Figure 2 shows typical curves of small signal gain, saturation gain, and saturation power output as a function of frequency. These curves are taken at a fixed helix voltage. The gain meets at least the design goal of 30 db over the frequency range of 7.0 to 12.5 Kmc. The gain is better than 20 db out to 14.0 Kmc. The power output meets at least the design goal of 10 dbm over the 7.0 to 11.0 Kmc range and drops to 7.5 dbm at 12.5 Kmc. Power output beyond 12.5 Kmc has not been measured because of lack of suitable equipment.

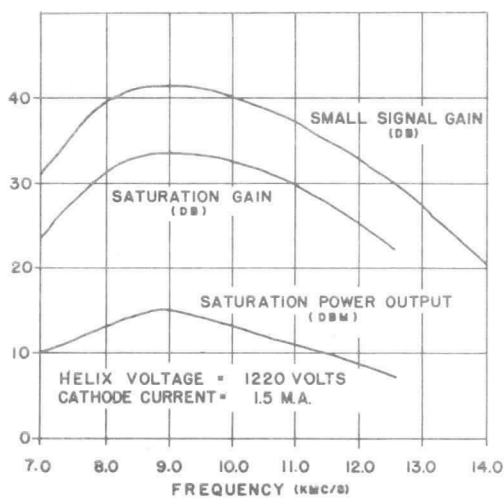

Power Output and Gain  
vs. Frequency

Figure 2

### B. Power Output vs. Power Input

Figure 3 shows curves of power output and gain as a function of power input at a fixed frequency. The output curve exhibits the normal traveling-wave tube characteristic; i.e., the power output is a linear function of power input until the output level is about 6 db below the saturation value. Beyond this point the curve levels off and then decreases as greater rf power input is applied. The gain curve shows that the small

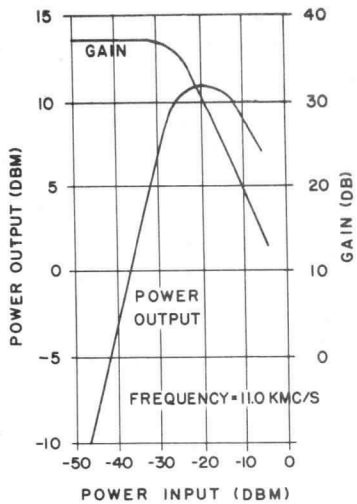

Power Output and Gain  
vs. Power Input

Figure 3

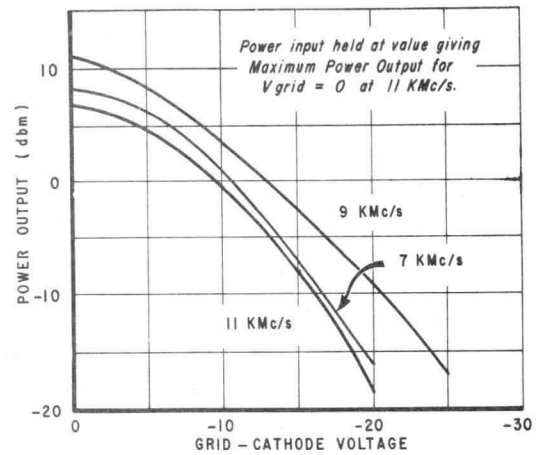

Power Output vs.  
Grid Voltage

Figure 4

signal gain remains constant as a function of power input until the power output curve starts to droop. At the power input level corresponding to maximum power output, the gain of the tube has dropped 6 to 7 db from the small signal value. If the tube is driven beyond the maximum power output point the gain continues to decrease.

### C. Grid Characteristics

The electron gun contains a non-intercepting grid electrode which has a high control action on the gain and power output of the tube. Curves of power output vs. control grid voltage are shown in Figure 4. It is seen that the gain and power output of the tube can be varied over an extremely wide range with the use of the grid and that the tube can be used as an electronically variable attenuator. The maximum attenuation that can be obtained amounts to the cold attenuation of the tube with the beam turned completely off and is approximately 80 db net attenuation. The power output variation from full gain value to maximum attenuation is something over 100 db which is obtained merely by variation of the control grid voltage.

The control grid is a low capacitance electrode that is capable of turning the beam on and off with milli-microsecond rise time when driven from a low impedance source. The total capacitance between the grid and cathode as measured between their respective pins at the base of the tube is 6.4 mmfd.

As an example, with a cw signal applied to the input of the tube, the tube can be used as an rf pulse modulator by applying the video pulses to the grid of the tube. Another application involves the use of the grid as the control element in the feedback loop of a system which maintains a constant output signal level from the tube over a wide frequency range independent of drive level.

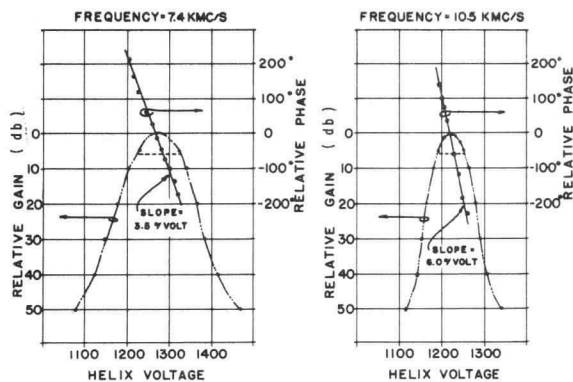

Gain and Phase Characteristics  
vs. Helix Voltage

Figure 5

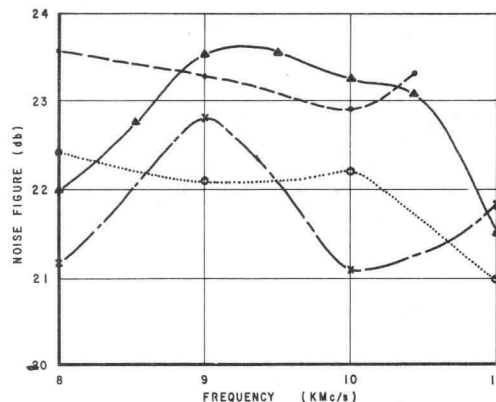

Noise Figure vs. Frequency  
for several different tubes

Figure 6

#### D. Voltage Response and Phase Characteristics

Figure 5 shows the variation of relative gain and relative output phase of the signal as a function of helix voltage for a fixed frequency. As helix voltage is changed away from the synchronous voltage value, the gain decreases in a parabolic fashion. Furthermore, the phase of the output signal relative to the phase of the input signal is a linear function of helix voltage. At 10.5 Kmc, a variation of plus or minus 32 volts from synchronism leads to a phase change of plus or minus  $180^\circ$ . The curves show that when the output phase has been shifted by plus or minus  $180^\circ$  the output of the tube has dropped just 6 db.

The phase shifting property of the traveling wave tube is now being recognized as a very useful one. Several schemes utilizing this property have recently been described.<sup>1</sup>

#### E. Noise Figure

This tube is built with a parallel flow Pierce gun and only moderate effort has been taken to reduce noise figure. In Figure 6 is plotted noise figure vs. frequency for a number of different tubes. Work is presently being done on a low noise version of this tube.

#### F. Miscellaneous Characteristics

The tubes are insulated to operate to an altitude of 50,000 feet. Two tubes in their respective solenoids spaced within 1/2 inch of one another can be operated with no appreciable effect on focusing or other tube characteristics.

---

IP. D. Lacy, Domestication of the Traveling-Wave Tube, paper presented at the 7th Region IRE Technical Conference, Phoenix, Arizona, April 1955. Reprinted in Huggins Laboratories' Engineering Notes, Vol. 1, No. 2, July, 1955.



## Power Supply Requirements

### A. Voltage and Current Requirements

Power supply for the tube must deliver 1200 volts at 2.0 milliamperes for the beam and between 250 to 450 volts at no current for the anode. The heater is 7.0 volts at 0.8 ampere. A 6.3 volt version of the tube will soon be available. The power supply for the solenoid must deliver 90 volts at 0.66 amperes dc.

### B. Ripple Requirements

If the helix voltage is filtered to give a peak to peak ripple of 0.1% there will be negligible amplitude modulation. However, this amount of ripple will lead to some incidental phase modulation of the rf signal being amplified. The phase excursion of the output signal with 0.1% peak to peak ripple is plus or minus  $3.6^\circ$  at 10.5 Kmc. The amount of incidental modulation can be determined from Figure 5. The tube is much less sensitive to ripple on the anode voltage than it is on the helix.

Although no exact figures have been measured as to the amount of amplitude modulation on the tube as a function of magnetic field ripple, it has been found that if the solenoid current is filtered to 0.1% peak to peak ripple there are no observable effects due to this factor.

### C. Stability of Helix Voltage.

A variation of helix voltage plus or minus 5 volts from synchronism will lead to a change of the output of 1 db at 11.0 Kmc. Thus, the supply should regulate and hold the helix voltage within 1 or 2 volts in order to avoid observable changes in output amplitude.

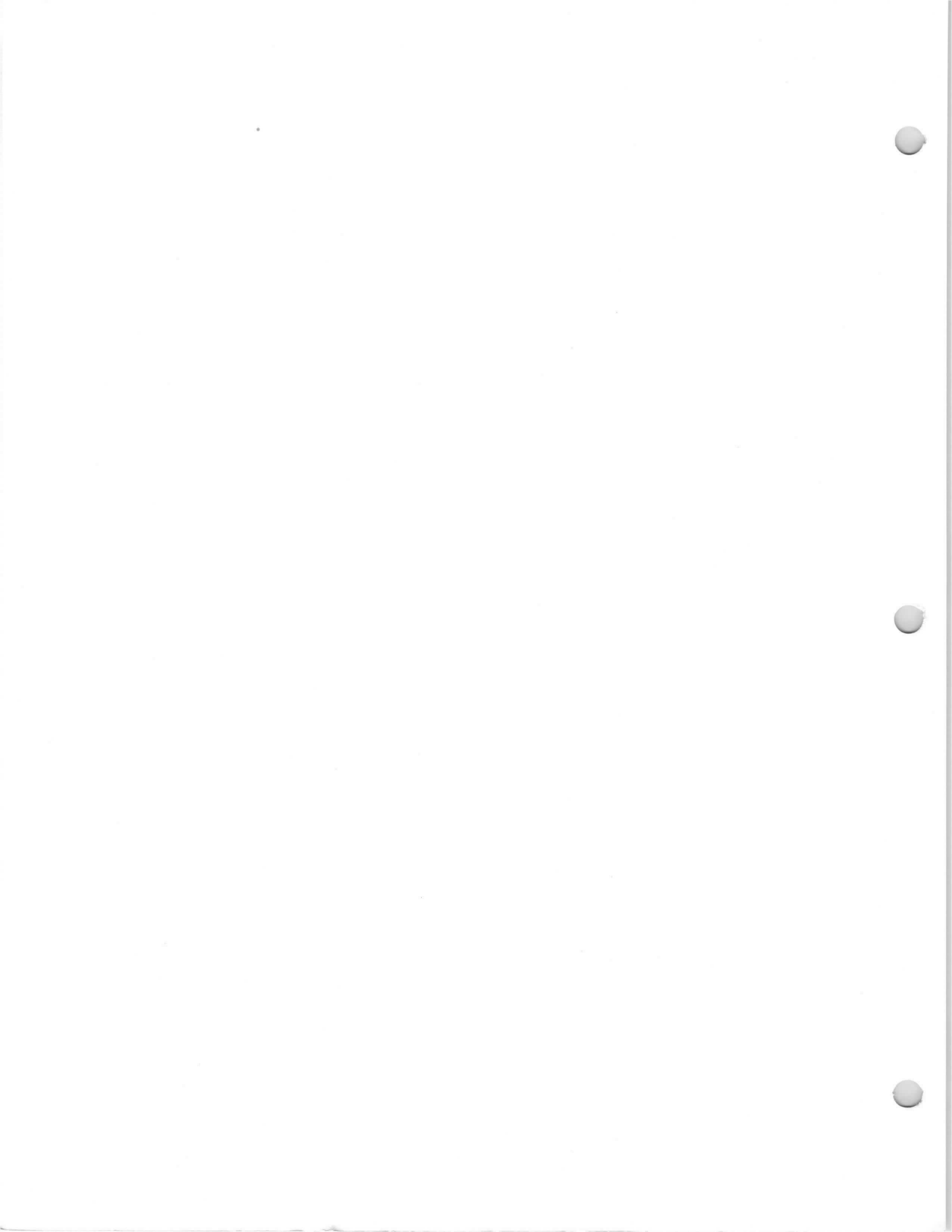



# HUGGINS LABORATORIES ENGINEERING NOTES

VOL. II, NO. 1

MAY 1956

Published by Huggins Laboratories

Menlo Park, California

## CASCADING TRAVELING-WAVE TUBES

In many systems applications, overall traveling-wave tube characteristics are required which are impossible to achieve in one tube. It then becomes necessary to cascade two or more tubes to achieve these results. It is the goal of these Engineering Notes to point out some of the problems that will be encountered.

This discussion has been divided into subtopics which touch upon the major points to be considered.

### Power and Gain Characteristics

Traveling-wave amplifier tubes do not saturate in the same manner as triodes, pentodes, and other conventional tube types. In these types as the power input is increased from a low level, the power output will first increase linearly, then level off and reach a maximum value which is practically independent of additional power input. This is indicated by the dashed curve in Figure 1.

The traveling-wave tube will have similar output characteristics up to the point of maximum power output after which further power input will result in a decreased power output. The power output will continue to decrease with further increase of power input. Excessive power inputs will result in further increasing and decreasing variations in the power output which will never approach the original maximum power output. Refer to the solid curve in Fig. 1.

POWER  
OUTPUT

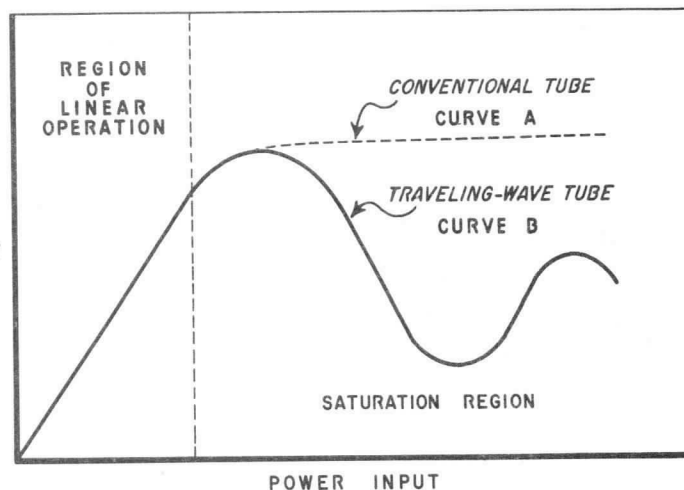

Comparison of Power Output Curves of Traveling-Wave Tubes and Conventional Low Frequency Tubes.

Figure 1

In order to define the significant power and gain parameters consider the operating characteristics of a travel-wave tube amplifier shown in Figure 2. The power output and gain are plotted as a function of the power input at a fixed frequency.

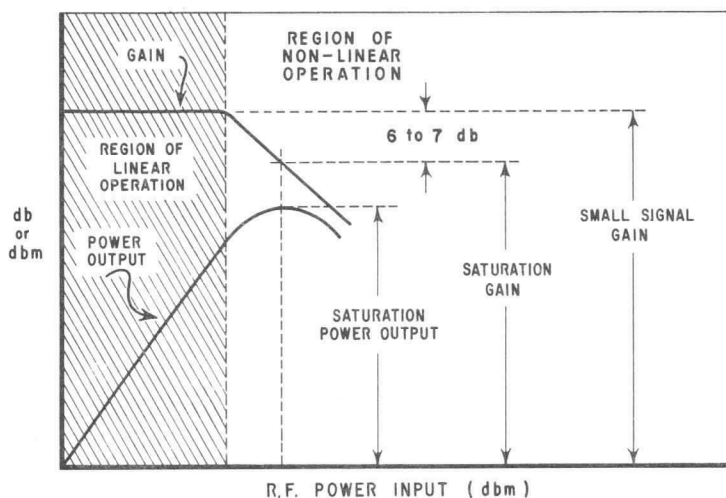

Typical Power and Gain Curves for a Traveling-wave Tube.

Figure 2

The gain and power characteristics are divided into the unsaturated or linear region and the saturated or non-linear region. In the linear region the power output is proportional to power input and the gain of the tube is constant and independent of power input level. The gain in this region is called the Small Signal Gain.

As the input level is increased the power output is no longer a linear function of the power input and the tube passes into the saturated region. The power output deviates further from a linear curve with increased power input until it reaches a maximum and then begins to decrease. This point of maximum power output is the Saturation Power Output of the tube.

In passing into the saturated region the gain is no longer a constant but is a function of the input level and decreases with increasing power input. The gain at the point of saturation is called the Saturation Gain and is approximately 6 to 7 db less than the Small Signal Gain.



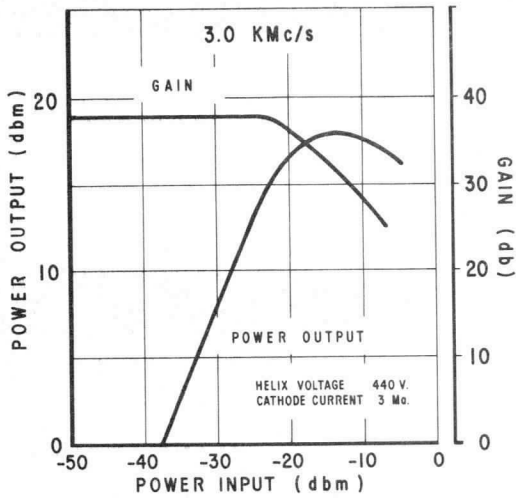

Power and Gain Curves of an HA-1 at 3.0 KMc

Figure 3

Figure 3 represents the Power and Gain Characteristics of the HA-1 (2-4 kmc, low power amplifier) taken at a single frequency. The algebraic difference between the power output and power input measured in dbm is equal to the gain. From these curves the Small Signal Gain, Saturation Gain, and Saturation Power may be ascertained at this frequency.

A continuous plot of these three parameters as a function of frequency is shown in Figure 4 for the same traveling wave tube. The individual values of these three parameters at the fixed frequency in Figure 3 may be checked at the corresponding frequency in Figure 4. The curves of Figure 3 and Figure 4 are normally included as a part of the descriptive data sheet for each tube type.

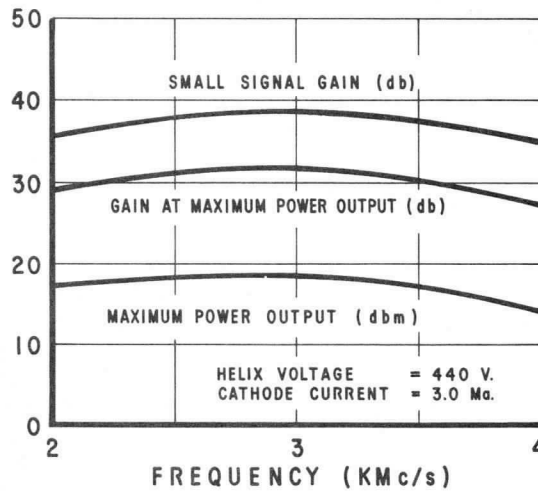

Power and Gain Curves of an HA-1 as a Function of Frequency.

Figure 4

## Noise Considerations

In addition to the gain and power characteristics of the traveling wave tube, it is of prime importance to consider the role of Noise Figure in applications where it is necessary to cascade one or more traveling wave tubes.

Ideally, an amplifier should amplify only the signal which is applied to its input and should not produce at its output any signals that do not exist in the input signal. In the practical case, signals are always present at the output which are not applied to the input. These spurious signals are divided into the categories of noise and hum. Since hum signals are usually a power supply problem which can be eliminated by proper design, noise signals will be taken as the limiting factor in our consideration of traveling wave tube noise.

The limiting noise levels in a system are those produced by the random fluctuations of the electrons in its conductors. The level of this noise power has a definite relationship to the system's absolute temperature and the bandwidth over which power is accepted. Thus, it is often referred to as "thermal noise." In a matched transmission system where maximum power transfer between the source and load occurs, the available noise power at room temperature is  $4.0 \times 10^{-21}$  watts per cycle of bandwidth. A more convenient way to express this noise level is  $-114$  dbm per megacycle of bandwidth.

This thermal noise of the system may be considered as a noise generator at the tube input whose output is being amplified by the traveling wave tube in the same manner and to the same degree that the input signal is being amplified. The output will consist of both the amplified input signal and the amplified system thermal noise.

In addition to the system thermal noise, there is an additional contribution of noise in the output of the tube that is associated with the traveling-wave tube itself. Whereas the thermal noise enters the amplifying portion of the tube by way of the input coupler, the tube noise enters the amplifying portion of the tube by way of the electron beam. An electron beam has noise components that are propagated along it and are amplified in the same manner that the system thermal noise is amplified.

The measure of the contribution of noise by the tube alone is known as the Noise Figure and represents the power ratio of the Signal to Noise ratio at the input to the Signal to Noise ratio at the output (usually expressed in db). This noise contribution can be considered as an equivalent noise generator at the input of the tube with the tube itself being a perfect amplifier and introducing no noise.

Figure 5 is an equivalent representation of these signal and noise components as they would exist at the input of a traveling wave tube amplifier.

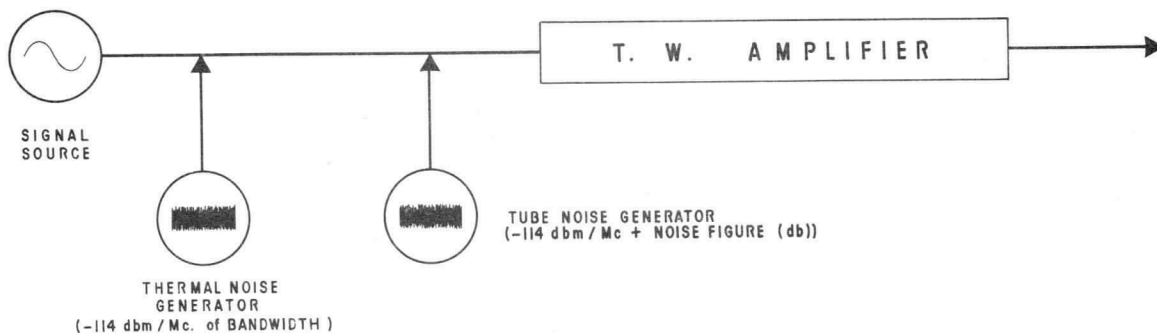

An Equivalent Representation of Noise Sources in a System Containing a Traveling-Wave Tube.

Figure 5

The magnitude of the noise is greater than the thermal noise level by the Noise Figure of the tube. For example, if the tube has a Noise Figure of 20 db, this number is added to the thermal noise level of -114 dbm per megacycle of bandwidth to -94 dbm per megacycle of bandwidth. The total noise power at the input is predominantly from this generator. (This will be true until tube noise figures are reduced to a few db at which time the thermal noise generator contribution will begin to be appreciable with respect to tube noise.) Further, suppose that somewhere in the system following the amplifier tube there is a band-pass filter which is 10 mc wide (e.g. an i-f amplifier). Noise is accepted over a 10 mc bandwidth and is a factor of 10 (i.e. 10 db) greater than for 1 mc. The noise generator at the tube input is then -84 dbm. If the tube gain is 30 db, the noise power level at the tube output is -54 dbm.

Another way of representing these various signal and noise components would be to plot them graphically on the power characteristics of the tube as shown in Figure 6.

The origin is taken as -114 dbm/mc for convenience. The thermal noise of the system is determined by accounting for the bandwidth of the following system. The equivalent noise power input to the tube is determined by adding to the thermal noise power (in dbm) the noise figure of the tube (in db). From the power characteristic curve the output noise power level is determined.

The dynamic range of the tube is limited on the low power end to the signal level which is just equal to the equivalent noise input level. It is limited on the high power end by the signal level which just drives the tube to saturation.

The dynamic range (in db) is then equal to the difference in these two power levels.

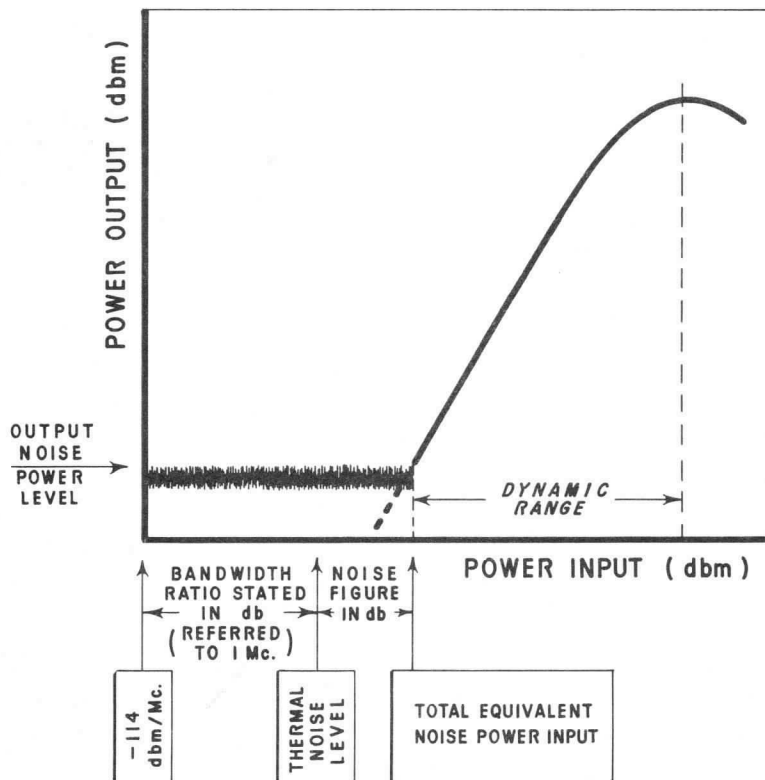

Combined Plot of Noise and Power Characteristics

Figure 6

### Sensitivity

One common measure of sensitivity is known as Tangential Sensitivity. It is the input signal power which is just equal to the total equivalent input noise power of the system. This definition is demonstrated in Figure 7 for an oscilloscope display of the detected output of a pulsed signal. Signal power input is read when the bottom of the noise with the pulse on is tangential to the top of the noise with the pulse off. The noise level which is seen in such a display is a function of the bandwidth of the system as well as its noise figure. Video as well as r-f bandwidth must be taken into account. If a square law detector is between the r-f and video portions of the system, then the calculation of equivalent bandwidth must be modified to account for this. For example, if the limiting r-f bandwidth ahead of the square law detector is 1000 mc wide (30 db with respect to 1 mc) and the video

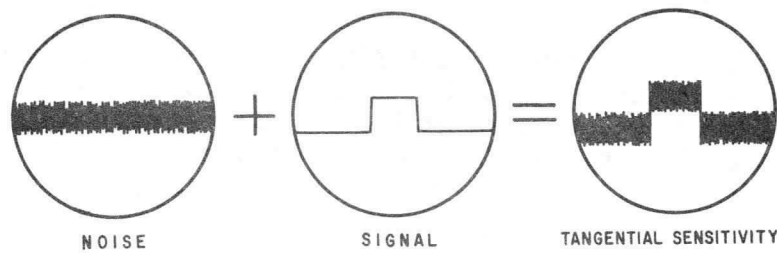

Representation of Tangential Sensitivity.

Figure 7

bandwidth following the detector is 10 mc wide (10 db with respect to 1 mc), then the sensitivity improvement due to this bandwidth reduction is  $(\frac{30-10}{2}) = 10$  db. Dividing by 2 accounts for the square law detector's effect upon the noise.

Some systems may be able to handle signals at levels below tangential and others may require signals much greater than tangential. However, this criterion does establish a common measure of system sensitivity.

There are two obvious ways to increase sensitivity. One method would be to employ a low-noise traveling wave tube amplifier. In any chain of amplifiers, it is the input amplifier that determines the noise figure of the complete chain provided it has sufficient gain so that its noise overrides that of subsequent stages. It is for this reason that great care is taken in the circuit adjustment and noise figure of any r-f input stage. Therefore, any decrease in noise figure of the individual input tube will directly improve the sensitivity of the complete system. Figure 8 shows the noise figure for the HA-11 (10 mw, 2-4 KMc amplifier) which is essentially an HA-1 with a low-noise gun replacing the standard gun. This low-noise gun design results in an improvement of approximately 10 db in noise figure.

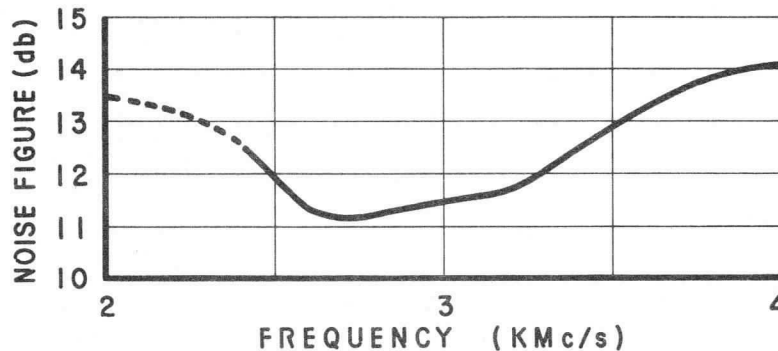

Noise Figure of an HA-11 as a Function of Frequency.

Figure 8



Another way to increase the sensitivity would be to decrease the overall system bandwidth. Increased sensitivity may be realized with ever decreasing bandwidth until a point is realized where the bandwidth becomes so narrow that it will not pass the spectrum that is necessary to accommodate the expected signal.

The noise figure of the tube and bandwidth of the system are two independent variables contributing to the sensitivity of the system and a change in one of these variables does not affect the other. In conclusion, it should be noted that any loss in the r-f circuit before the input coupler to the traveling wave tube amplifier represents a decrease in sensitivity and must be included as an additional factor to be considered with the thermal noise and the noise figure of the tube. This input loss, in db, must be subtracted directly from the sensitivity of the system.

### Limiter Characteristics

In some microwave applications it is desirable to have a device which will give a constant power output over a very large dynamic range of power inputs. One method of achieving this involves the utilization of the saturation curves of two dissimilar traveling wave tube amplifiers. In this application the two saturation curves are combined so as to keep the output tube in a state of saturation for a large range of input power levels of the first tube. This can best be illustrated by considering a numerical example of this principle applied to two of our standard tubes.

For example, consider the saturation curves of two of the S-Band production type tubes. The HA-1 is a 10 milliwatt amplifier tube and the HA-2 is a 1 watt amplifier tube.

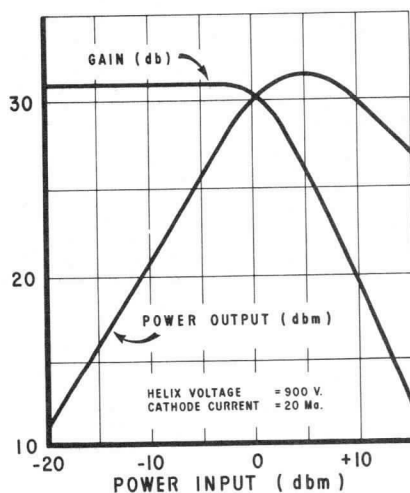

Power and Gain Characteristics of an HA-2 at 3.0 KMc.

Figure 9

These curves are illustrated in Figure 3 and Figure 9 respectively. Assume that the specification calls for a constant power output of 1 watt  $\pm 1-1/2$  db at 3 KMc. This output is to be constant over as large a range of inputs as can be easily achieved. It is seen from Figure 9 that if the power inputs were on the order of -2 dbm to +13 dbm that the requirement would be met with this single tube. However, suppose the requirement here calls for a wider dynamic range encompassing a lower level of power inputs.

Examining the HA-2 saturation curve further, we note that the input power of +13 dbm results in 28.5 dbm power output and that

any further drive would tend to give less power than the specifications call for. It is then desirable to have a second traveling wave tube that will saturate at +13 dbm at this frequency. Such a condition is met by operating the HA-1 amplifier tube at about one-half its rated beam power. This saturation curve is shown in Figure 10.

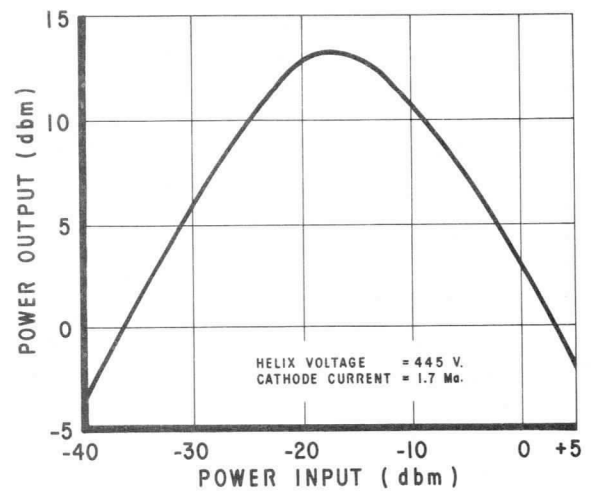

Power Characteristic of an HA-1 at 1/2 Rated Beam Power at 3 KMc.

Figure 10

These two curves are combined in Figure 11 with the power output scale of the HA-1 superimposed on the power input scale of the HA-2. The HA-2 has its beam power adjusted to give a saturated power output of 31.5 dbm at the required frequency of 3 KMc. It is seen that when the 28.5 dbm points of the HA-2 are projected on to the saturation curve of the HA-1 that the dynamic range over which these power output conditions will be met is -39 to +5 dbm. The input power can vary over a range of 25,000 to 1 and the power output will vary only over a 2:1 ratio.

The power output for any particular power input is obtained by projecting these individual saturation curves to form a power output curve as a function of power input. As an example, consider any arbitrary input as Point A and project it as shown. Point by point projections result in the complete power output curve.

This degree of limiting may be extended by the addition of a second HA-1 which could result in a power output variation of 30 dbm  $\pm 1/4$  db for 62 dynamic power input range. Comparable limiting may be achieved with only two tubes where they are especially designed for this type of operation. Depending upon the required power output, this tube combination could entail 2 HA-2's, 2 HA-1's or one of each. Limiting can be done in other bands with other tube types.

Although this discussion has been concerned with a single frequency, tubes can be made which have flat gain vs frequency characteristics and wide band limiting is possible.

#### Cascaded Amplifier Characteristics

In many applications it is desirable to obtain more amplification and power output than can be achieved with one tube. It is then necessary to cascade two or more traveling wave tubes to achieve this added performance. The factors to consider are the noise figures of the individual

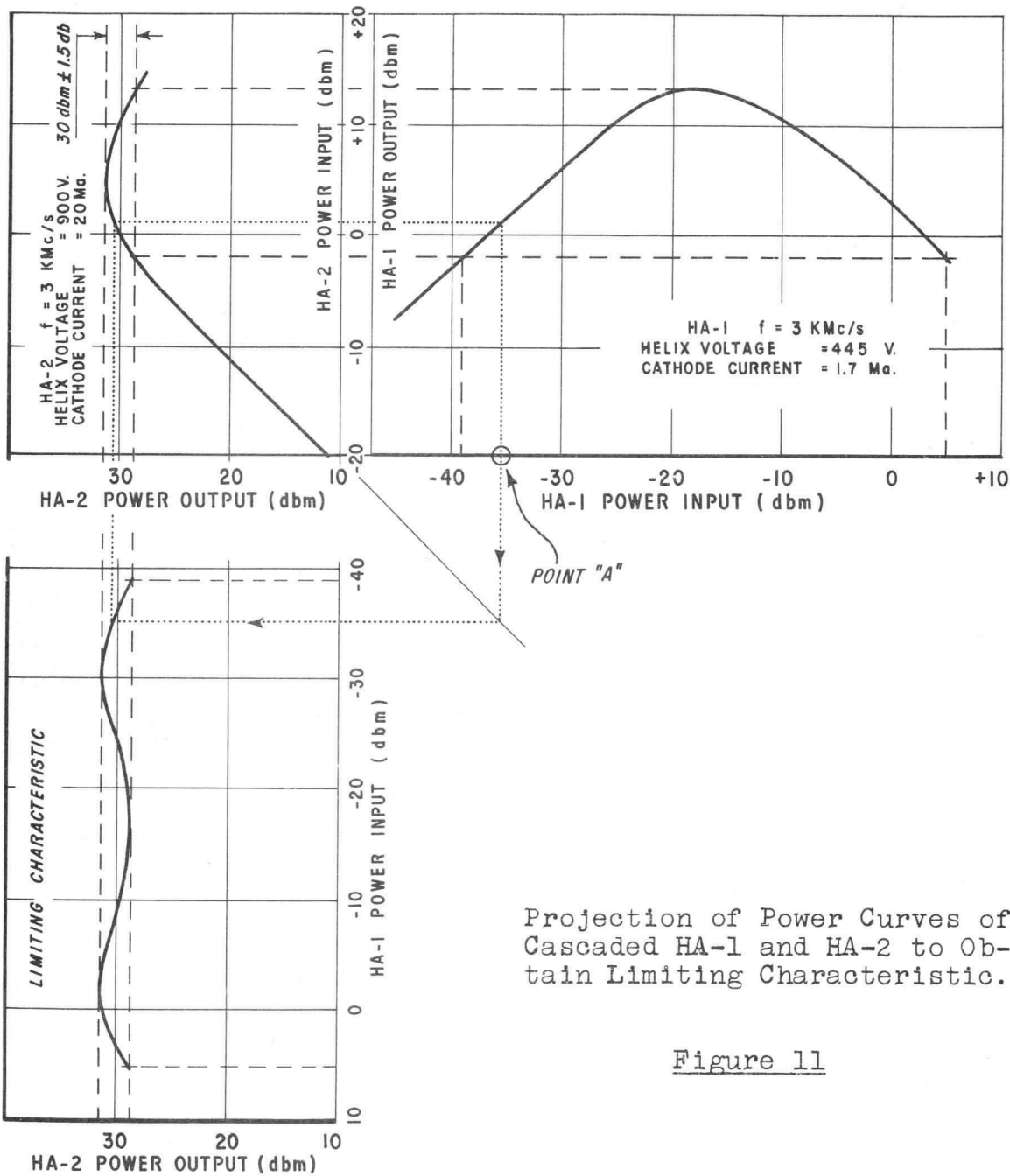

Projection of Power Curves of Cascaded HA-1 and HA-2 to Obtain Limiting Characteristic.

Figure 11

tubes and saturation characteristics and how these parameters are interrelated when they are superimposed on each other as they were in Figure 11.

The problem is twofold. The noise of the input tube may saturate the output tube resulting in an unusable display or output. The signal power output level of the input tube may saturate the output tube resulting in a very small or limited linear dynamic input range. Both of these conditions are illustrated in the following numerical example which will bring out most of the problems that must be solved in this type of operation.

Assume that it is necessary to achieve a 40 db linear dynamic input range with a gain of 55 db at 3 KMc. Assume further that the system bandwidth is to be equal to the bandwidth of the tube. This amount of gain is not usually possible with a single tube so it becomes necessary to cascade two tubes. The first solution may appear to cascade two HA-1's since individually they will both have a small signal gain in excess of 30 db which should easily meet our requirements with a total gain of over 60 db.

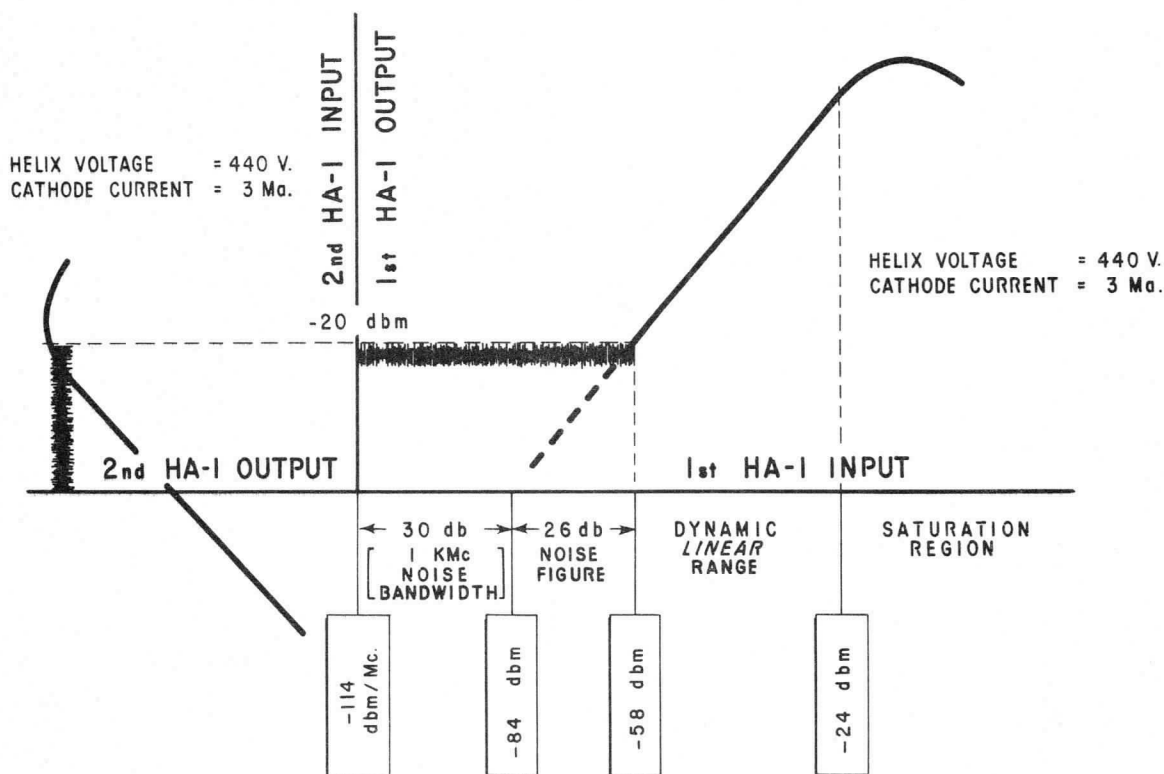

Projection of Power Curves of Two Cascaded HA-1's.

Figure 12

In Figure 12 the power curves of two HA-1's are superimposed in the same manner that was followed previously in Figure 11. The noise figure considerations are also included wherein a noise figure of 26 db is assumed as well as an effective 3 db noise bandwidth of 1 KMc.

Examination of Figure 12 reveals that this solution has failed on two counts. (1) The linear dynamic input range of the first tube is only 34 db (58-24) and falls short of the required 40 db. (2) The equivalent noise power input of -58 dbm at the input of the first tube when amplified by 40 db to -18 at the output of the first tube will drive the second tube to saturation. This results in 16 dbm of noise at the output of the second tube with a corresponding zero linear dynamic range. Any increase in input power will drive

the second tube further into saturation. Such a combination may not even work well as a noise source since it is operating in a saturated condition with the resulting clipping of the noise peaks.

The two factors that made this combination fail were the noise figure of the first tube which limited the dynamic input range and the power handling capabilities of the second tube which allowed it to be immediately saturated by the first tube.

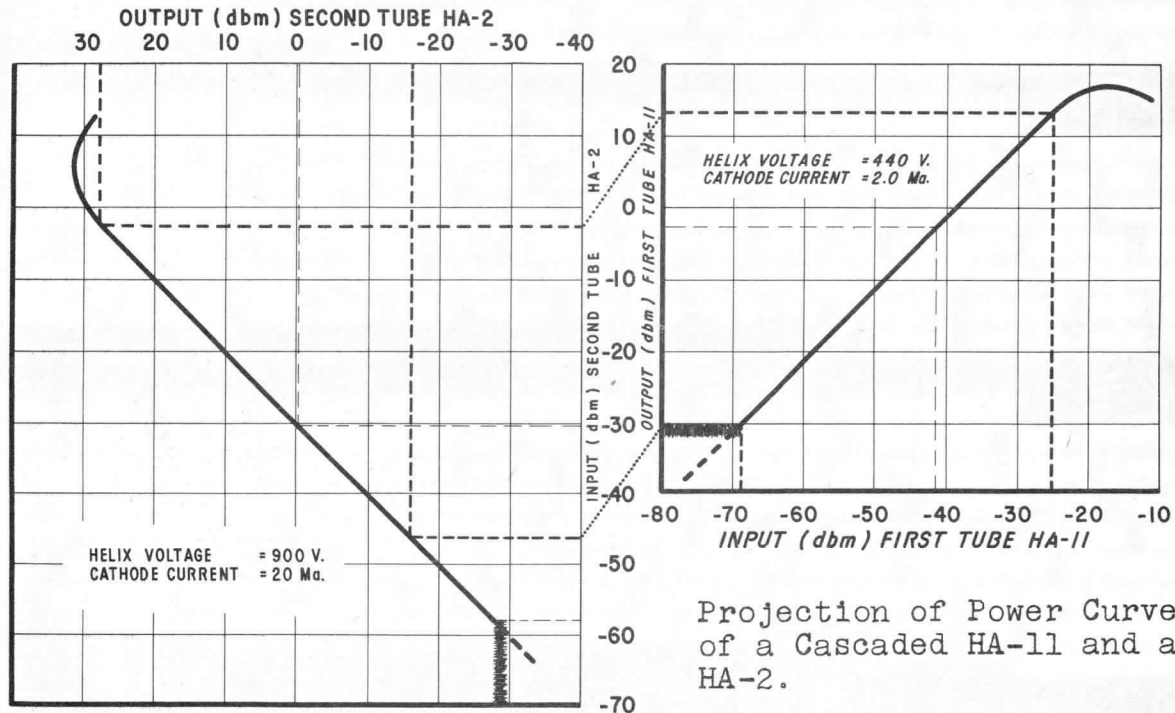

Projection of Power Curves of a Cascaded HA-11 and an HA-2.

Figure 13

Consider the combination of a low-noise HA-11 followed by a medium power HA-2 as superimposed in Figure 13. The HA-11 has a noise figure of at most 15 db across the 2.0 to 4.0 KMc band. The HA-2 has a noise figure of at most 25 db over this frequency band and has the same 1 KMc effective noise bandwidth. This places the equivalent noise power input at -69 dbm for the HA-11 and -59 dbm for the HA-2.

Inherently the HA-11 has a linear dynamic range of 44 db (69-25). However, when operated directly into the HA-2, the overall dynamic range of the cascaded pair is only 27 db (69-42) because the HA-2 is driven into its saturation region at -2 dbm input. The overall gain for this limited linear range is 69 db (69-0). In order to obtain the greatest dynamic linear input range, both tubes must be made to saturate simultaneously.

Since the 69 db gain is not required a more reasonable solution is to put an attenuator between the first and second tube in order to keep the first tube from saturating the second tube at low input levels as it did in Figure 13. The padded combination is shown on the same figure where the superimposed first



tube output and the second tube input power levels have been moved in respect to each other by the amount of the pad. This is shown by the dotted oblique lines between the first tube's output and the second tube's input. The value of this padded attenuation between the two tubes is the difference between the highest linear output of the first tube (+13 dbm) and the highest input resulting in a linear output of the second tube (-2 dbm). This gives 15 db as the value for this pad.

The final overall characteristics are a 44 db (69-25) linear dynamic range and a small signal gain of 53 db (69-16). This closely approximates our original goals.

As these two input-output ordinates were effectively shifted in respect to each other in Figure 13 by the interstage 15 db pad, it should be noted that the equivalent noise power input of the HA-11 came within 11 db (58-47) of falling within the noise region of the second tube. If this had occurred, the limiting sensitivity of the system would have been determined by the noise figure of the second tube and not the noise figure of the first tube.

One other method of operating the tubes which was not worked out in this example would be to operate the HA-11 at reduced beam power so that it would have saturated simultaneously with the HA-2. Operating in this fashion, the dynamic range of the HA-11 (and thus of the overall combination) would have been reduced because noise figure does not improve in proportion to reduction of saturation power output. In fact, noise figure decreases by only 1 or 2 db as beam current (beam power) is decreased.

-- R. A. Huggins



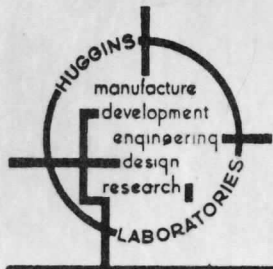

# HUGGINS LABORATORIES ENGINEERING NOTES

VOL. 3, NO. 1

MARCH 1957

Published by Huggins Laboratories

Menlo Park, California

## PHASE MODULATION OF TRAVELING WAVE TUBES

Although the traveling wave tube is best known and utilized for its broadband characteristics, it has many narrow band characteristics that are equally important. One of the more important narrow band characteristics is its usefulness as a device to shift frequency by phase modulation, or what is sometimes referred to as "transit-time modulation."<sup>1</sup> When the correct modulating waveforms are applied, this can result in a single side-band modulation characteristic which may be used in doppler simulators, coherent pulse simulators, homodyne systems, and similar frequency shift or frequency sensitive applications.

This discussion will be confined to the use made of the phase shift properties of a traveling wave tube which result from a variation of the helix voltage. This is the most satisfactory method for obtaining this phase shift and is the only one adapted to shifts of  $2\pi$  radians or greater. Suffice it to say that other tube or circuit parameters that affect the electron beam configuration will also to some degree affect the phase relationship between the input and output signals. These include such things as position and magnitude of the magnetic field, cathode current, as well as the magnitude of the input signal if the tube is being driven into the saturation region. Phase modulation due to these secondary causes will be the subject of a later Engineering Note.

### Serrodyne Or Single Side-Band Modulation

The velocity of a signal passing through a traveling wave tube is determined by the combination of the physical configuration of the helix and the electron beam. Normally, the helix voltage is adjusted so that the electron velocity of the beam and the wave velocity on the helix are essentially equal. Varying the helix voltage and thus the corresponding electron velocity will perturb the velocity of electromagnetic waves on the helix. The velocity

<sup>1</sup> Raymond C. Cumming, "The Serrodyne Frequency Translator", Proceedings of the I.R.E, February 1957.



changes tend to advance or retard the phase of the output signal with respect to the phase of the input signal.

Consider Fig. 1. The phase delay or advance is plotted as a function of the helix voltage for the HA-1 at a fixed frequency of 3.0 kmc. An 18 volt modulating voltage when applied symmetrically about the synchronous value of helix voltage will shift the phase  $360^\circ$  or  $2\pi$  radians. This manifests itself as a  $\pm 180^\circ$  or a  $\pm \pi$  radian phase variation from the condition of zero relative phase shift at the synchronous voltage condition.

Since phase is essentially a linear function of helix voltage, constant  $d\phi/dt$  can be obtained by applying a linearly increasing voltage as a function of time. For example, let the voltage waveform begin at a voltage corresponding to  $-\pi$ . Then as voltage increases, the phase will soon reach the value  $+\pi$ .

A phase of  $+\pi$  OR  $-\pi$  means exactly the same thing, therefore the voltage can be instantaneously changed back to its starting value, the output phase will be unchanged and waveform can be repeated. This waveform is simply a linear sawtooth voltage with infinitely rapid flyback time. At the output of the tube it appears that phase is increasing indefinitely with time at a

constant value of  $d\phi/dt$ . This means that the input frequency is shifted by an amount equal to  $d\phi/dt$  since time rate of change of phase is equal to frequency shift.

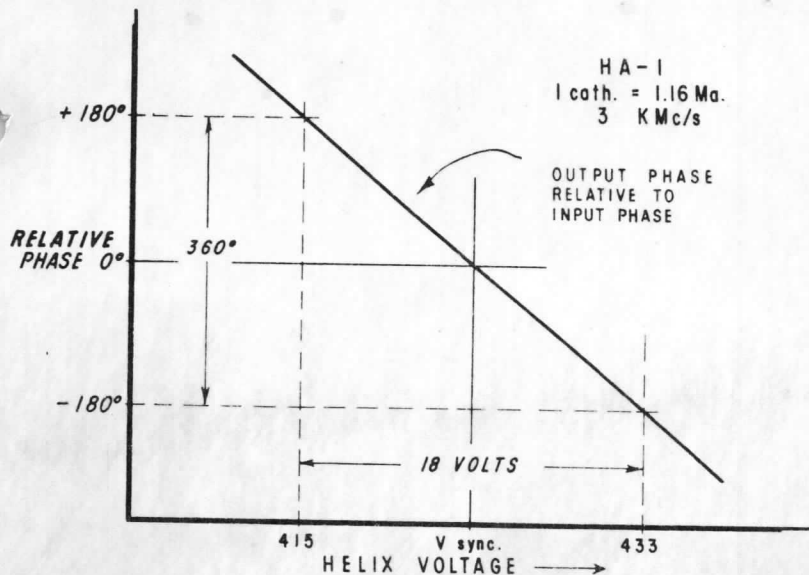

Phase Shift vs Helix Voltage for HA-1 TWT

Figure 1

A sawtooth voltage which swings symmetrically about the synchronous helix voltage is usually used in applications where these phase shift characteristics are required. This is somewhat analogous to allowing the second hand of a clock to complete 59 seconds of the minute and then quickly turning it backwards in the last second to its initial starting place after which the process repeats itself. The apparent result is a continuous advancement in phase wherein the

algebraic summation of the revolutions never exceeds one revolution. To continue the analogy a little further, the center about which this variation occurs is analogous to the synchronous voltage and would be at the half minute point since both of these variations are a  $\pm$  variation about a center of reference. This repetitive sawtooth voltage type of modulation where the phase is changed by  $360^\circ$  per voltage swing results in single sideband modulation of the original frequency wherein its original frequency is shifted either higher or lower by the value of the repetition rate of the sawtooth voltage.

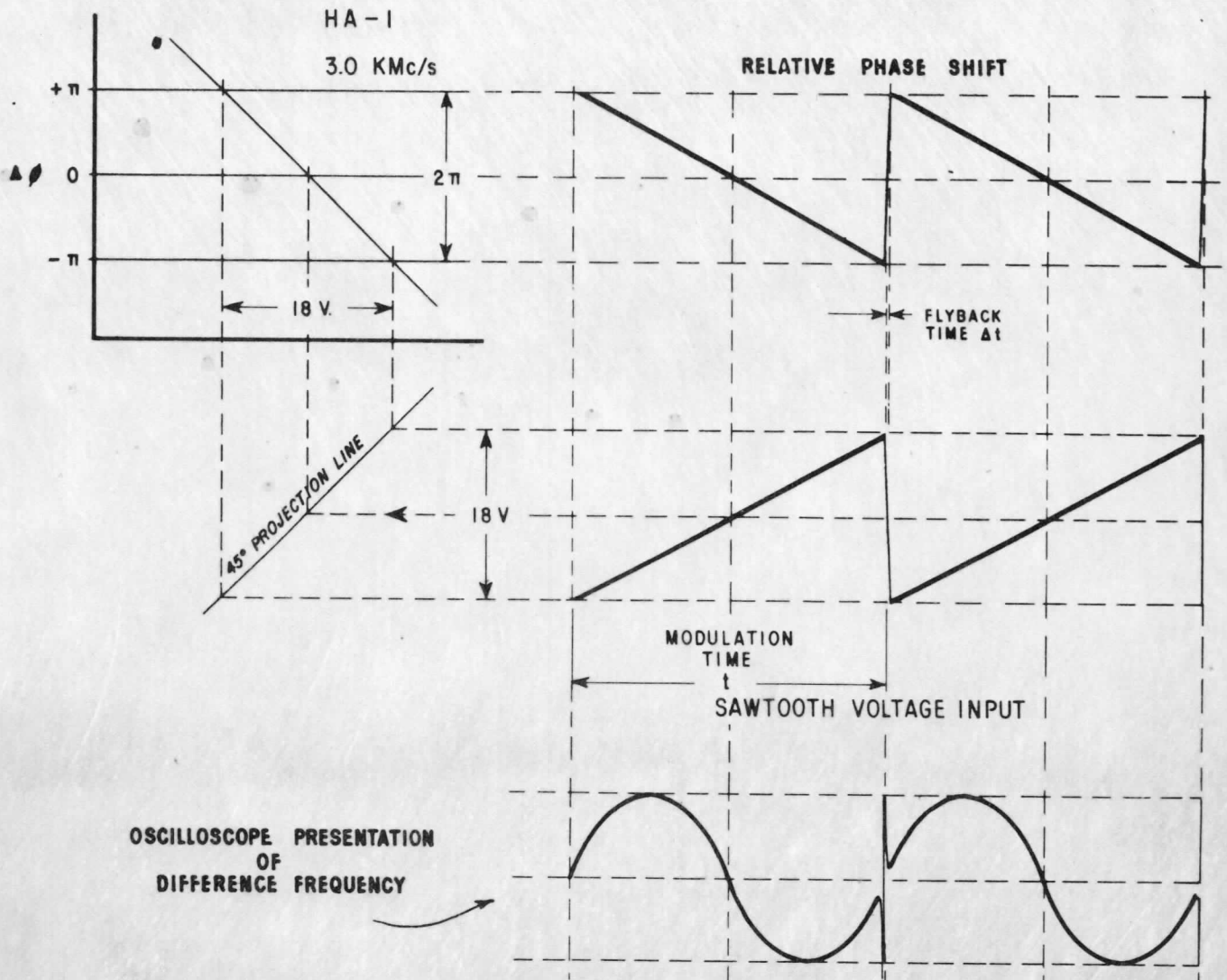

Phase Modulation Time Reference Diagram

Figure 2



A negative slope on the modulating voltage results in a decrease in frequency output as compared with the original input frequency; a positive slope on the modulating voltage results in an increase in frequency output as compared with the original input frequency.

For example, a peak-to-peak sawtooth voltage of 18 volts with a one second period superimposed on the d.c. voltage applied to the helix of an HA-1 traveling wave tube will result in an output signal shifted in phase with respect to the input signal by  $360^\circ$  per second. Thus, the output signal frequency is shifted by one cycle per second, or one cycle per sawtooth period. Likewise, if the frequency of the sawtooth is 1000 cps, the output phase is shifted  $360^\circ$  per  $1/1000$  of a second, corresponding to a frequency shift of one cycle every  $1/1000$  of a second or 1000 cycles per second which again is equal to the sawtooth frequency.

Figure 2 gives a composite picture of this action wherein a sawtooth voltage of period  $t$  with a flyback time of  $\Delta t$  is applied to the curve of Figure 1. In this figure we have taken some liberties with our illustrative projections in that the sine-wave shown is an oscilloscope presentation of the difference frequency between the input and output frequencies. This oscilloscope presentation will be explained below and is included here for clarity and further reference.

The linear sawtooth voltage input results in a linear increasing or decreasing phase output as shown. Directly below the sawtooth input voltage is plotted the difference frequency signal which would be obtained if the input and output signals were mixed. The difference frequency is made up of two components. The predominate frequency component is equal to  $1/t$  and this side band contains practically all of the available r.f. power. The other frequency component is equal to  $1/\Delta t$  and occurs only during flyback time. Since it is a much higher frequency little energy is expended during its cycle and it represents only a small energy component of the total signal spectrum.

In operating one of these phase-modulation frequency-shift systems, it is very important to obtain the difference frequency shown above and use it as a means of monitoring the overall system performance. The resulting sinewave may then be used as a criteria in setting up the various voltages required to obtain the optimum modulation conditions. A simple method of setting up and observing this phenomena is shown in Figure 3. Essentially, this consists of a signal generator providing a local oscillator signal for the crystal mixer as well as the input to the traveling wave tube. The relative magnitudes of the two signals that are fed into the crystal mixer are proportioned so as to insure linear mixing. The original frequency presents a power level of 0 dbm which is sufficient to ensure linear mixing while the shifted frequency from the traveling wave tube has an input to the mixer of -30 dbm.

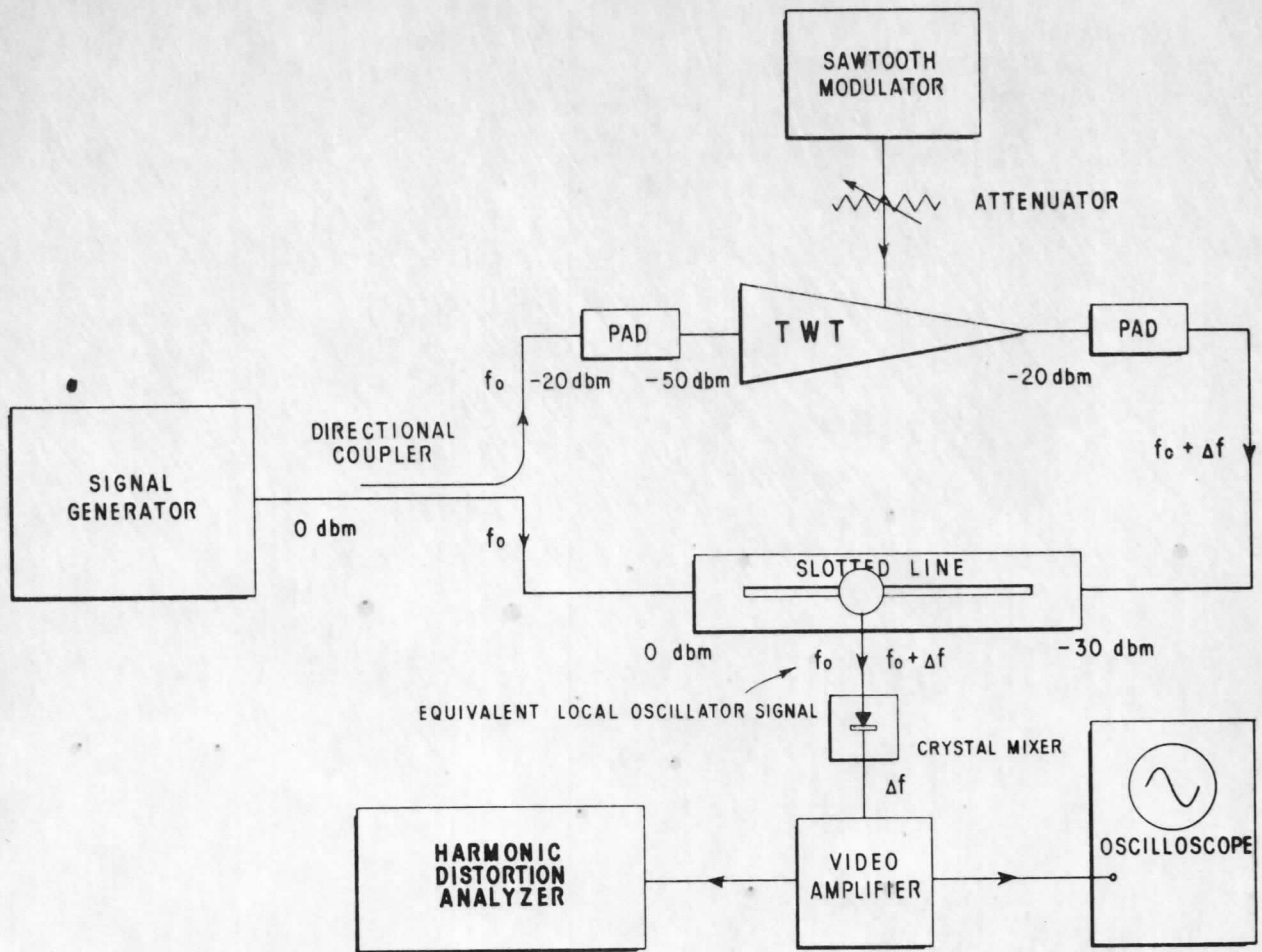

Block Diagram of Measuring Equipment

Figure 3

For simplicity and ease of operation, the crystal in a slotted line was used as the mixer which permits the examination of the mixed signal at any arbitrary phase by moving the probe position. The helix of the traveling wave tube is modulated with a sawtooth voltage and the output is fed to the other end of the slotted line where it mixes with the unaltered original input signal. The resulting difference frequency is amplified and displayed on an oscilloscope or applied to the distortion measuring equipment.

The correct value of voltage swing and its center or average value may be determined by either observing the best sinewave on the oscilloscope or by setting the system up for minimum harmonic distortion. The adjustments consist of determining the magnitude of the sawtooth voltage and adjusting the helix voltage so that the modulating voltage swings about the synchronous voltage. A third adjustment that may not be

available due to system considerations is to adjust the pick off point on the slotted line for an optimum phase relationship of the flyback time. This is due to the fact that the mixer is usually fixed in position in the r.f. circuit of a normal system. Even if the mixer could be moved for optimum conditions it would be at the correct position for only selected frequencies across any operating band.

Incidental Amplitude Modulation and Phase Distortion

Since distortion may greatly affect the operation of the system in which these signals are to be used, it is appropriate to consider the types of distortion, their causes, and how they may be remedied.

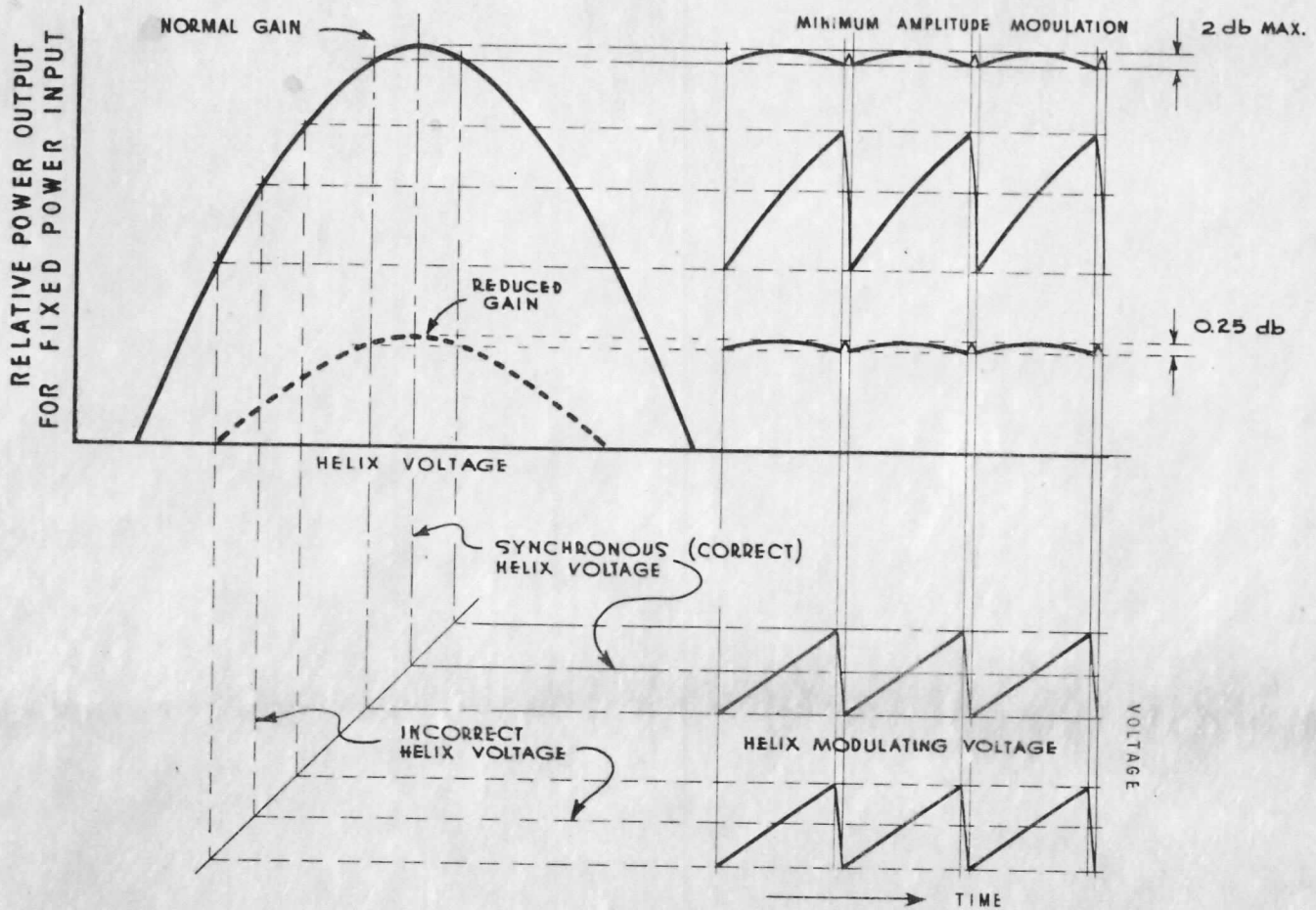

Amplitude Modulation Derived from Voltage Modulating the Helix

Figure 4



One may think of spurious signals in the output of the tube as distortion. This results from the fact that the unwanted frequencies are harmonically related to the frequency shift,  $\Delta f$ , and can be represented by a spectrum of frequencies centered about the shifted carrier and spaced from one another by  $\Delta f$ . If the output of the tube is linearly mixed with the input signal as shown in Figure 3 and the difference frequency signal is examined, the unwanted frequencies are then merely harmonics of the difference frequency. Their value can then be determined simply by making a harmonic distortion measurement.

In the foregoing discussion, it has been assumed that the phase change was a linear function of the helix voltage change. This is only approximately true since the phase change varies as the square root of the helix voltage change. However, since the helix voltage change is such a small percentage of the synchronous helix voltage the approximation of a linear phase characteristics is almost valid. In the case of the HA-1 the helix voltage change for a  $2\pi$  radian shift in the phase is only about 5% of the synchronous helix voltage. Assuming a perfect sawtooth voltage the slight remaining curvature in the phase characteristic would result in a harmonic distortion of 2 to 3 percent if there were no other sources of distortion.

Consider the distortion that may be attributed to not operating the modulating voltage about the correct helix voltage. Figure 4 represents two operating conditions where the modulation voltage is centered on the correct helix voltage and on an incorrect helix voltage. In this figure the modulating sawtooth voltage of the proper amplitude to swing the phase  $\pm\pi$  radians is projected on the normal Gain vs Helix Voltage curve. The correct d.c. component of the voltage is equal to the synchronous voltage which gives the maximum gain. This produces the least amplitude modulation for the required helix voltage swing. This amplitude modulation is responsible for harmonic frequency distortion which produces AM sidebands in the spectrum of the shifted frequency. On a standard tube (gain greater than 30 db) the value of this superimposed amplitude modulation is of the order of 2 db. This may be lowered to approximately 1/4 db by the proper applications of cold loss which reduces the tube gain from approximately 40 db to 10 db. It should be pointed out that this reduction of AM cannot be accomplished by decreasing gain through reduction of beam current. It must be done when the tube is manufactured by loading the helix with cold loss.

In most traveling wave tube applications and in the data presented in our data sheets the helix is operated at a fixed value for all frequencies under consideration. This represents truly broadband untuned operation. These phase shift applications require that the traveling wave tube operate at its point of maximum gain which in turn is determined by the synchronous helix voltage. In other words to minimize incidental AM, the helix voltage must be optimized at each frequency.

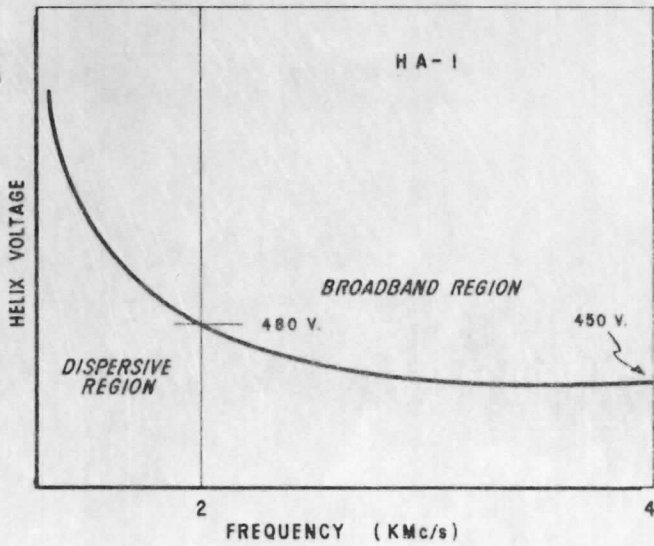

Dispersive Curve for HA-1

Figure 5

Figure 5 illustrates how this optimum helix voltage or synchronous voltage varies as a function of frequency. This curve is known as the Dispersive Curve for the traveling wave tube.

The curves of the Phase Shift as a Function of Helix Voltage of Figure 1 and the curve of the power output as a Function of Helix Voltage of Figure 4 are superimposed in Figure 6 for various fixed frequencies. The required helix voltage for a  $2\pi$  radian shift in phase is indicated. The incidental amplitude modulation for this phase shift is also noted.

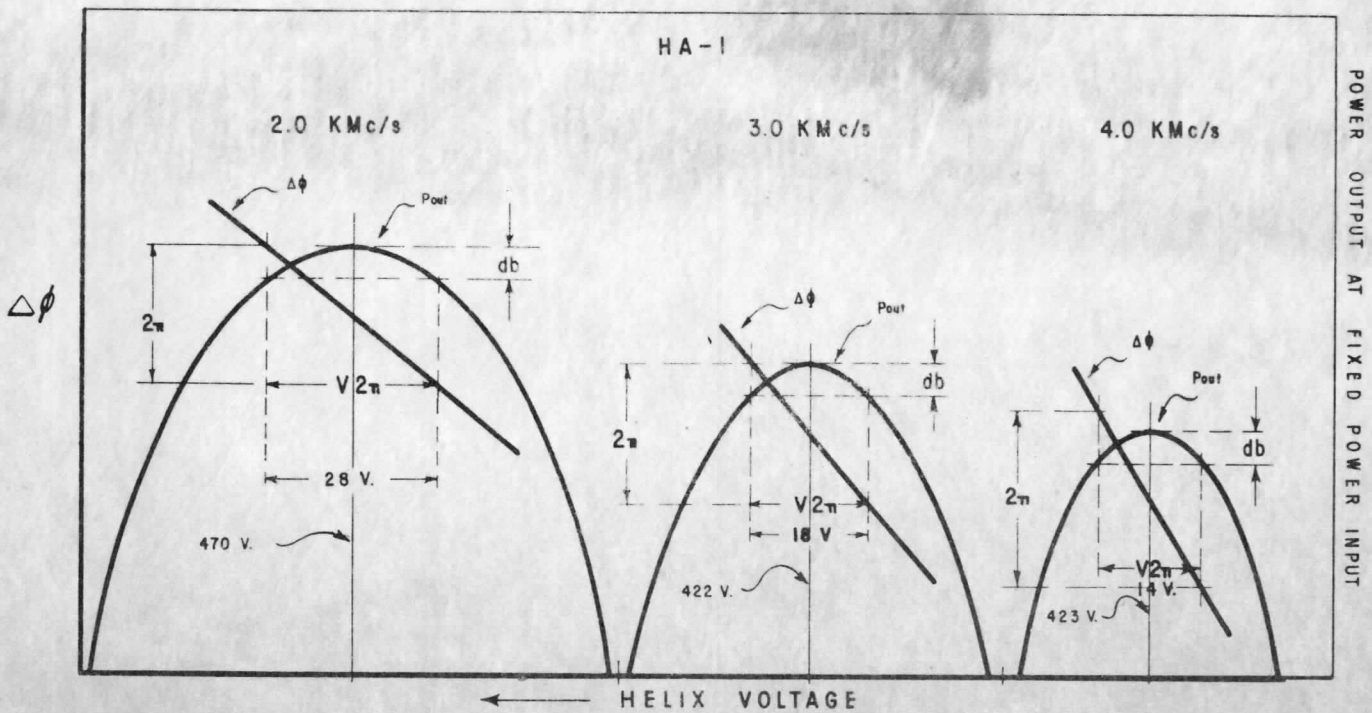

Gain &  $\Delta\phi$  vs Helix Voltage

Figure 6



There are a few features of this series of curves that stand out. It is seen that the optimum operating voltage has increased with decreasing frequency in accordance with Figure 5. The magnitude of the required modulating voltage has increased with decreasing frequency. Its magnitude is roughly proportional to the wave length. This is plotted in Figure 7.

The gain response as a function of helix voltage becomes increasingly wider as the frequency decreases. This fact coupled with the increasing modulating voltage as the frequency decreases results in practically the same value of amplitude modulation across the operating band. This accounts for the observation that the degree of distortion is nearly independent of frequency.

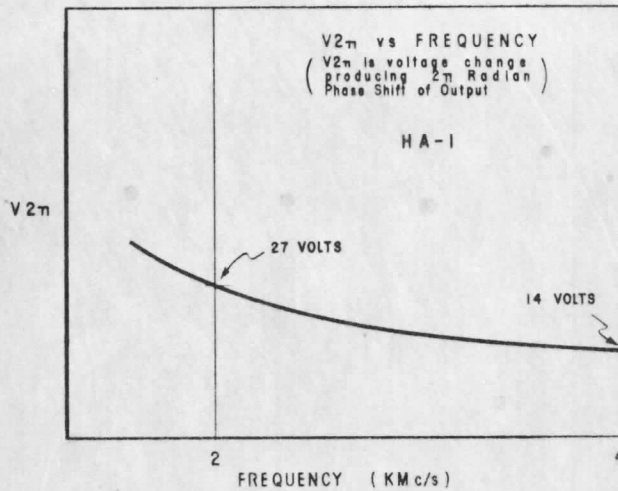

Peak to Peak Voltage Required for a 2 $\pi$  Radian Shift in Phase

Figure 7

voltage is varied. This voltage adjustment may be monitored by visual inspection of an oscilloscope presentation or by the use of a harmonic distortion analyzer.

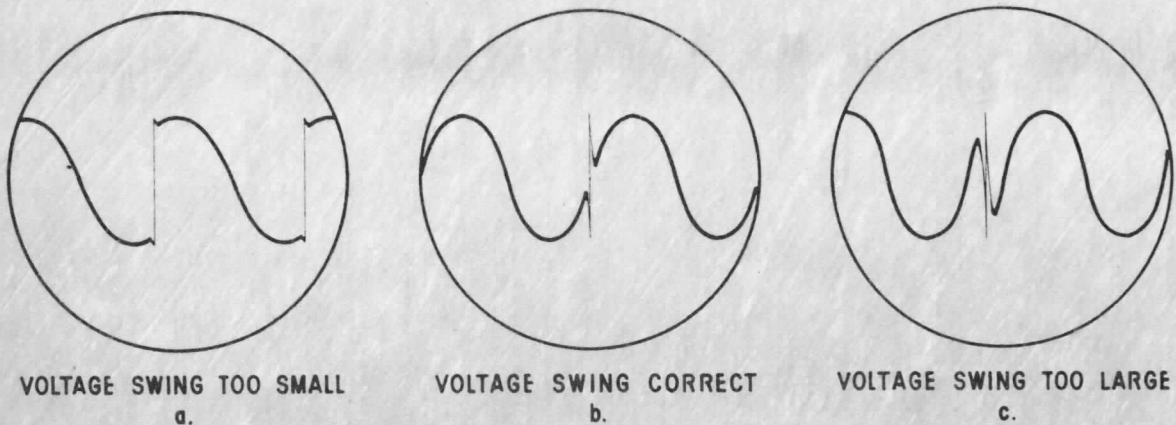

Difference Frequency Presentation for Various Amplitudes of Modulating Voltage

Figure 8

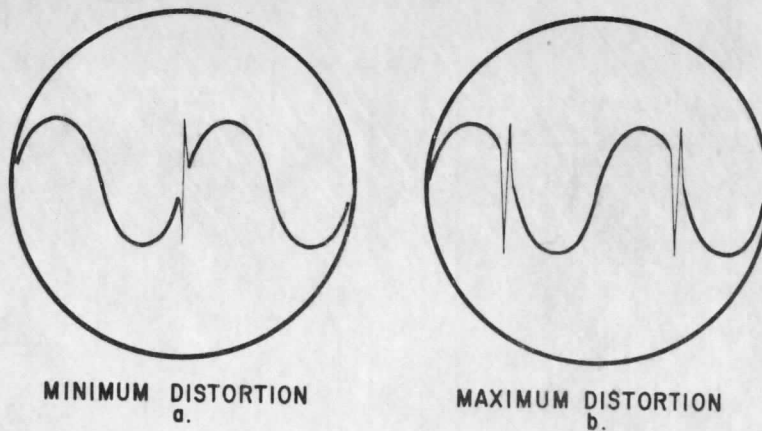

The Phase Relationship of the Flyback  
Time Retrace for Min. & Max. Distortion

Figure 9

Another source of distortion which may be adjusted for a minimum value in the test setup illustrated in Figure 3 is the relative phase of the original signal and the altered signal at the mixer. The amount of distortion in the difference frequency output can be varied by moving the probe carriage on the slotted line. In most applications this adjustment would not be available since the usual system would have to perform satisfactorily under conditions of arbitrary phase relationships at the fixed position of the mixer.

Figure 9 illustrates the position of maximum and minimum distortion. It is readily seen that this is a function of the position of the flyback time retrace on the difference frequency. The difference in per cent harmonic distortion between the optimum pick off condition and the poorest pick-off condition is 3 to 5%.

A final source of distortion could be attributed to any nonlinearity of the sawtooth voltage. Techniques are readily available so that this factor can be practically neglected. The distortion due to the flyback time retrace may be minimized by making this time as short as possible. Such a precaution will result in two beneficial effects. One, the energy confined to this retrace time will be practically negligible compared with energy contained in the main trace. Two, the frequency represented by the retrace time will be so high as to be outside of the frequency range of interest.

Distortions from 5% to 7% were achieved in the test setup previously described. These figures could have been reduced by 2% to 3% by using tubes which had been adjusted for low-gain and flat response as illustrated in Figure 4.

It is thus possible to achieve these single sideband modulations or frequency shifts with very small per cent distortions which correspond to unwanted sidebands which are 30 to 40 db below the carrier amplitude.

#### Limits of Frequency Shifting Technique

It is possible to accomplish frequency shifts of the order of tens of megacycles. The only limitation is to design the circuitry that can modulate the helix with a sawtooth voltage at these high frequencies. In the 10 to 50 mc range, distributed amplifiers are used for this purpose as well as some schemes involving charging of stray capacitances.<sup>1</sup> At frequencies above 50 mc, or the order of several hundred megacycles, frequency shifting with multiple sideband response may be accomplished by sine wave modulation of the helix. The usable frequency shifts are represented by the lowest order sideband of the resulting frequency spectrum. The limiting condition that the tube imposes on such high frequency modulation is encountered when the period of the applied waveform becomes appreciable with respect to the transit time of the electron beam through the tube. There is also the possibility that the modulating frequency would be limited by resonant conditions of the helix as a transmission line.

-- D. R. Bellis  
-- R. A. Huggins



# HUGGINS'

## TRAVELING WAVE TUBES



EASY TO OPERATE AND ADJUST  
HIGH PERFORMANCE  
RELIABLE  
RUGGED

### PERFORMANCE CHARACTERISTICS

#### 1. High Gain

Small Signal Gain is a minimum of 30 to 35 db depending on frequency range.

Saturation Gain for the medium power tubes is at least 30 db so that the tube can be driven to full power output with a milliwatt signal generator.

#### 2. Wide Bandwidth

Most tubes provide rated gain and power output over 2:1 frequency range without readjustment of voltage or current and have useful gain and power output over a much wider frequency range.

#### 3. Stability (Freedom from oscillations)

Spurious low level oscillations have been eliminated. The tubes are stable under short circuit conditions. Total reflections of arbitrary phase can be simultaneously connected to the input and output r.f. cables without oscillation.

#### 4. Low Regeneration

Periodic fluctuations of gain as a function of frequency due to regenerative feedback are held to a minimum. Variations of less than plus or minus 1 db can be expected into a matched load. Gain fluctuations are not excessive with high VSWR loads.

#### 5. Low VSWR

The VSWR measured with the tube not operating is less than 1.7:1 for most tubes. Both the input and output VSWR measured with the tube operating does not differ appreciably from the cold VSWR except at one or two isolated frequencies within the band.

## 6. Holes

Holes in gain and power output as a function of frequency are virtually eliminated.

## 7. Grid Control

All low power tubes have a grid electrode which enables variation of gain and power output over wide ranges with relatively small voltage variation. At least 40 db reduction in gain is provided anywhere within the operating band with 50 volts negative applied to grid. If sufficient negative grid voltage is applied so that the beam current is cut off, the total reduction in output can be as great as 90 to 100 db.

## 8. Vibration Effects

When solenoid and tube are mounted on shock trays such as used in aircraft equipment installations, the effects on operating characteristics are not appreciable with 10 G's vibration at 60 cycles in all directions of vibration.

## 9. Long Life Characteristics

Minimum of 1000 hours for low power tubes.

Minimum of 500 hours for medium power tubes.

## OPERATING CHARACTERISTICS AND ADJUSTMENTS:

1. A minimum number of voltages are required for operation.

Low Power tubes require:

- a. Heater Voltage Supply (6.3 - 7.0 volts A.C.)
- b. Helix and Collector Voltage Supply (same voltage)
- c. Anode Voltage Supply (anode draws practically no current)
- d. Grid Voltage Supply (optional since grid is at cathode potential for full gain)

Medium Power tubes require:

- a. Heater Voltage Supply (7.0 volts A.C.)
- b. Helix Voltage Supply
- c. Collector Voltage Supply (helix voltage plus 150 volts)
- d. Anode Voltage Supply (anode draws no current)

2. Simple Adjustments to Set Tubes into Operation.

Tubes require no RF measurements or adjustments which use a signal generator for setting into operation.



- a. Merely adjust tube position in magnetic field for minimum helix current.
  - b. Apply helix voltage given on data sheet with a 1 per cent accuracy meter.
  - c. Apply anode voltage for rated current.
3. Safety to Operating Personnel

There are no exposed coolers, leads, or terminals which have voltage with respect to ground.

## PHYSICAL CHARACTERISTICS

### 1. Rugged Capsulation

- a. All metal capsule has tube permanently locked in place inside.
- b. Tubes will easily withstand shock of normal handling by unskilled or untrained personnel.
- c. No breakage can result from handling of the uncapsulated tube since tube is permanently locked inside capsule.
- d. All mechanical adjustments on tube are made inside of capsule at the factory.

### 2. Capsule Size

Capsule size of the amplifier tubes is 1.0 inch maximum diameter. This small size allows the tubes to be operated in efficient, small diameter solenoids.

### 3. Input and Output Cables

The tubes are provided with input and output leads consisting of flexible high-temperature 50 ohm coaxial cable. Either BNC or Type N connectors can be provided in most frequency ranges.

## SPECIAL MODIFICATIONS OF TUBES

### 1. Power Lead Filters

Filters can be provided within the tube capsule to prevent RF feedthrough into the tube on the D.C. voltage leads. Filters are necessary in high signal strength areas to eliminate unwanted signals from entering the amplifying channel. Filters are also necessary to prevent oscillations due to stray feedback when high gain tubes are operated in tandem.

Filters provide at least 35 db of dissipative loss in series with each lead going into capsule.

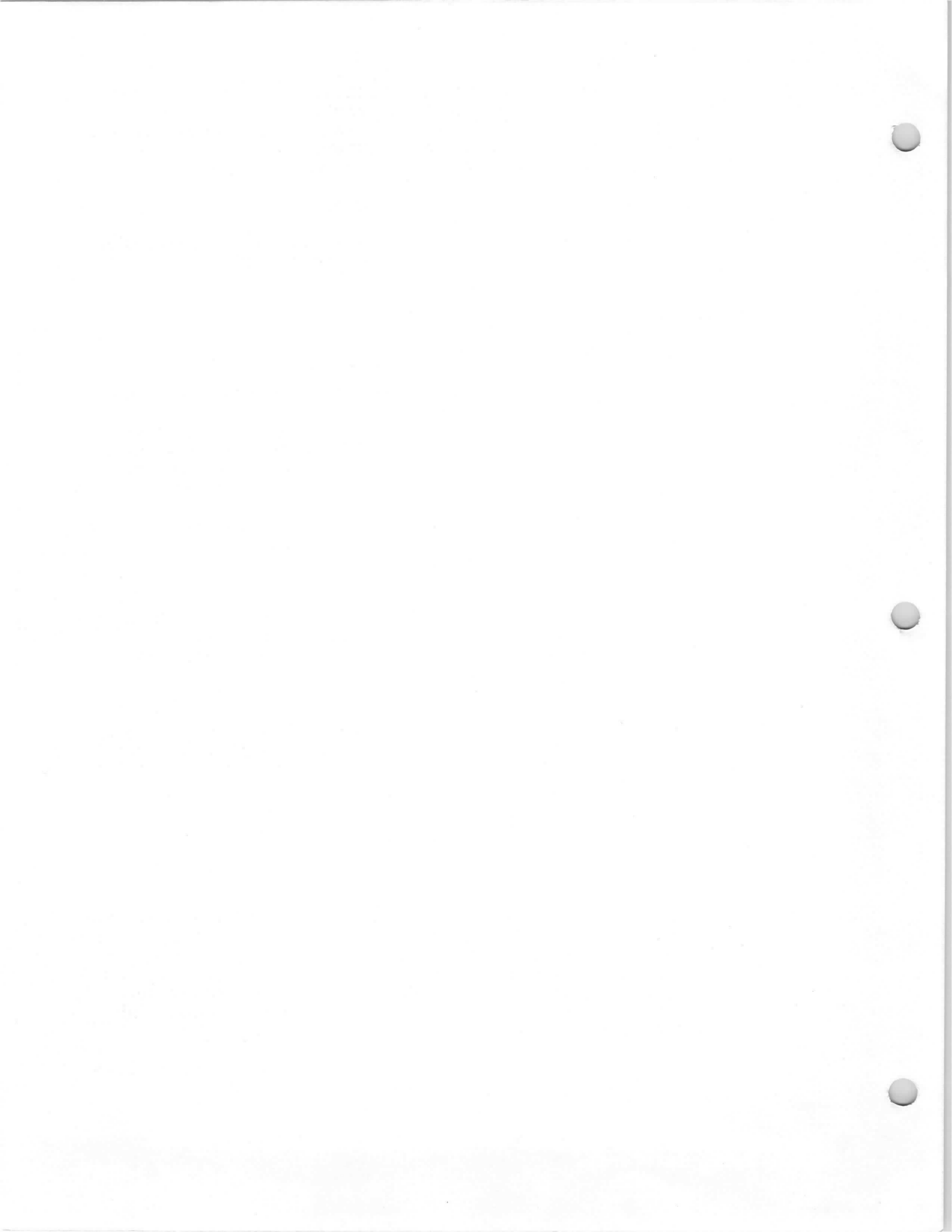

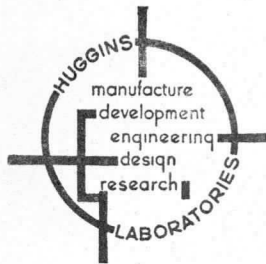

# TRAVELING-WAVE TUBE AMPLIFIERS

Power	Frequency in Kilomegacycles						
	0.5 - 1.0	1 - 2	2 - 4	4 - 8	7 - 14	10 - 20	20 - 40
0.1 - 1.0 MILLIWATTS							
1 - 10 MILLIWATTS	DHA-3	DHA-2	DHA-1		* HA-15		
10 - 100 MILLIWATTS	* HA-7	HA-5 * HA-17	HA-1 HA-11	HA-3	HA-4		
0.1 - 1.0 WATTS					HA-10 HA-13		
1 - 10 WATTS			HA-2 HA-12	HA-6	* HA-9		
10 - 100 WATTS							

\* New products not previously announced.  
8-1-56

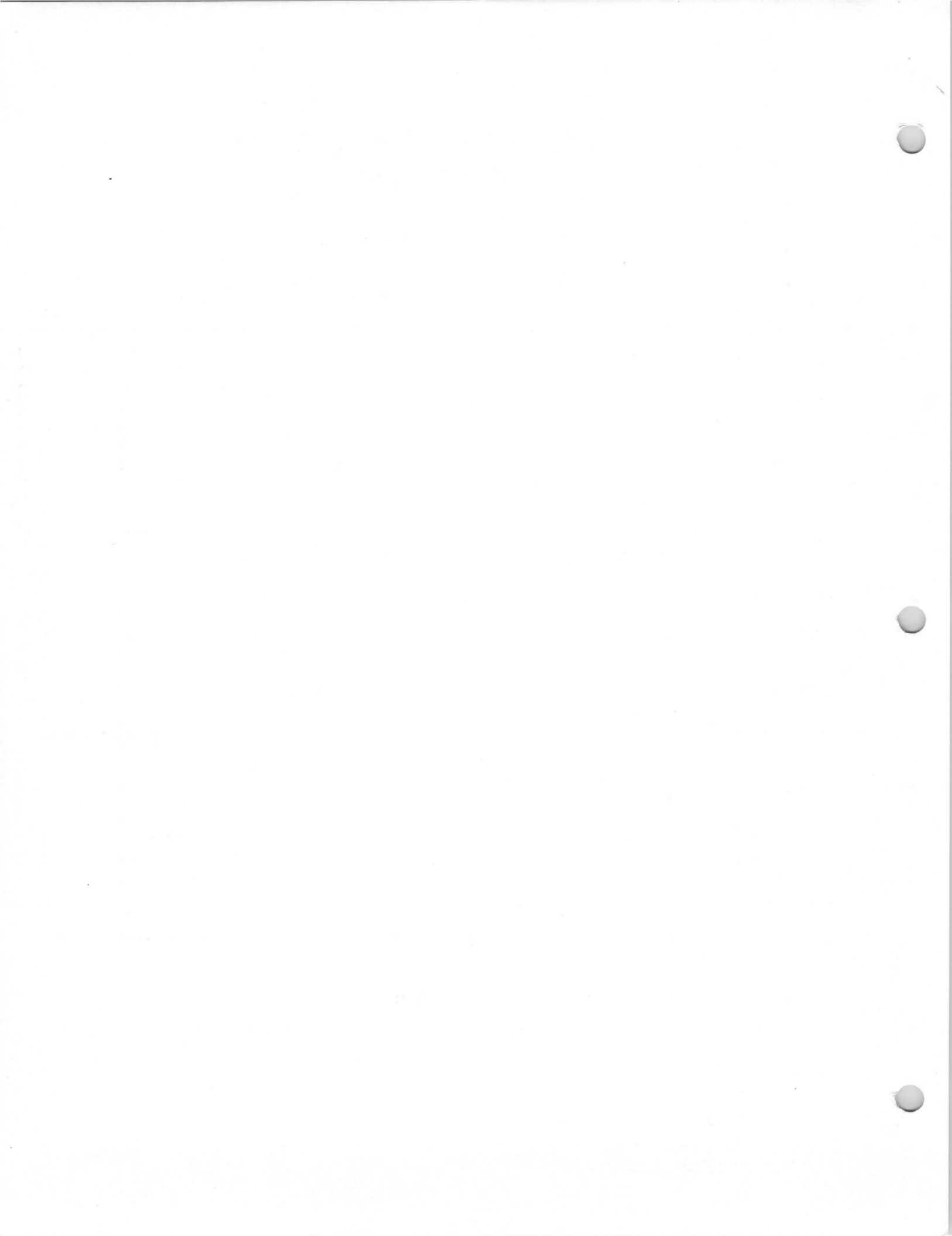



HUGGINS VOL 2 TABLE OF CONTENTS

Please note the following changes      9/1/58  
Changes in specifications              1/Feb/58  
Performance Characteristics, Operating Characteristics and adjustments,  
Physical Characteristics, Special Modifications of Tubes, Solenoids 1/4/5<sup>5</sup>  
D.C, Connector Information              12/1/57

<u>TYPE NO</u>	<u>PAGES</u>	<u>DATE ISSUED</u>
HA1	1	MARCH 1961
HA1B	1	12/16/54
HA2	1	APRIL 1961
HA2B	1	1/1/55
HA3	1	10/1/57
HA3B	1	1/14/55
HA4	1	APRIL 1961
HA4B	1	1/12/55
HA5	2	5/1/58
HA6	1	6/15/58
HA7	2	9/1/58
HA8	1	OCTOBER 1959
HA9	1	3/15/58
HA10	2	6/15/58
HA 11	1	SEPTEMBER 1961
HA12	1	3/1/56
HA13	1	3/1/56
HA14	1	3/1/58

<u>TYPE NO</u>	<u>PAGES</u>	<u>DATE ISSUED</u>
HA15	1	7/1/58
HA16	1	6/1/57
HA17	1	3/1/58
HA18	1	9/1/58
HA1 9	1	3/1/58
HA20	1	5/1/58
HA21	1	7/1/58
HA 22 ha	1	3/1/58
HA23	1	12/1/57
HA24	1	3/15/58
HA 25	1	MARCH 1960
HA26	1	AUGUST 1960
HA27	1	AUGUST 15 1959
HA28	1	3/1/58
HA29	3	1/1/58
HA30	1	6/1/58
HA31	1	3/1/58
HA32	1	APRIL 1960
HA33	1	5/1/58
HA34	1	1/1/58
HA35	1	2/15/59
HA36	1	2/15/59
HA37	1	7/1/58
HA39	1	FEBRUARY 1961
HA40	1	3/15/58

<u>TYPE NO</u>	<u>PAGES</u>	<u>DATE ISSUED</u>
HA43	1	MARCH 1960
HA44	1	5/1/58
HA45	1	MARCH 1960
HA 46	1	MARCH 1960
HA 47	1	MAY 1960
HA49	1	2/15/59
HA51	1	2/15/59
HA52	1	MARCH 1960
HA53	1	JANUARY 1961
HA54	1	AUGUST 1961
HA58	1	MARCH 1960
HA60	1	AUGUST 1961
HA61	1	SEPTEMBER 1961
HA62	1	SEPTEMBER 1961
HA71	1	NOVEMBER 1960
HA72	1	NOVEMBER 1960
HA73	1	JANUARY 1961
HA80	1	11/22/60
HA85	1	2/20/62
HA86	1	1/9/61
HA89	2	AUGUST 1961
PA1	1	2/15/59
PA3	1	11/1/57
PA4	1	DECEMBER 1960

<u>TYPE NO</u>	<u>PAGES</u>	<u>DATE ISSUED</u>
PA5	1	NOVEMBER 1960
PA6	1	6/1/58
PA7	1	2/15/59
PA8	1	APRIL 1960
PA9	1	NOVEMBER 1960
PA10	1	NOVEMBER 1960
DHA1	1	5/1/55
DHA2	1	5/1/55
DHA3	1	5/1/55
DA1	1	FEBRUARY 1960
DA2	1	FEBRUARY 1960
DA3	1	FEBRUARY 1960
DA4	1	6/1/57
BA1	1	6/1/57
BA2	1	6/1/57
BA4	1	FEBRUARY 1960
HO1	1	FEBRUARY 1961
HO1 A	1	7/1/55
HO2	1	FEBRUARY 1961
HO2B	1	3/1/55
HO2B Supplement	1	8/22/55
HO3	1	FEBRUARY 1961
HO3A	1 <del>7/1/55</del>	7/1/55
HO4	1	FEBRUARY 1961
HO4B	1	7/15/55

<u>TYPE NO</u>	<u>PAGES</u>	<u>DATE IS SUED</u>
HO9	1	APRIL 1960
HO10	1	2/15/58
HO11	1	2/15/58
HO13	1	2/15/58
HO14	1	FEBRUARY 1961
HO17	1	FEBRUARY 1961
HO18	1	FEBRUARY 1961
HO19	1	APRIL 1960
HO20	1	MARCH 1960
HO21	1	MARCH 1960
HO22	1	APRIL 1960



PLEASE NOTE THE FOLLOWING CHANGES:

TUBE TYPE	DATE	CHANGE
HA-1	7-1-57	CAPSULE LENGTH ..... 16 5/8 INCHES ✓
HA-2	7-1-57	<u>ELECTRICAL</u> HEATER CURRENT ..... 1.0 AMP (MAX.) ✓ CATHODE CURRENT ..... 25.0 MA ✓ HELIX CURRENT ..... 300µA (MAX.) ✓ COLLECTOR CURRENT ..... 25.0 MA (MAX.) ✓
		<u>TYPICAL OPERATION</u> HELIX CURRENT ..... 150 µA ✓
HA-5	5-1-58	HEATER CURRENT ..... 1.3 AMPS (MAX.) ✓
HA-11	7-1-58	CAPSULE LENGTH ..... 18 1/8 INCHES ✓
HA-14	3-1-58	CAPSULE LENGTH ..... 15 5/8 INCHES ✓ CATHODE CURRENT ..... 1.5 MA (MAX.) ✓
HA-15	7-1-58	CAPSULE LENGTH ..... 13.8 INCHES ✓
HA-16	6-1-57	HELIX CURRENT ..... 300 µA (MAX.) ✓ ANODE VOLTAGE ..... 0 TO 550 VOLTS ✓ CAPSULE LENGTH ..... 13 5/8 INCHES ✓
HA-17	3-1-58	R.F. CONNECTORS ..... TYPE N MALE ✓ CAPSULE LENGTH ..... 15 5/8 INCHES ✓
HA-19	3-1-58	R.F. CONNECTORS ..... TYPE N MALE ✓ CAPSULE LENGTH ..... 15 5/8 INCHES ✓
* HA-20	5-1-58	CAPSULE LENGTH ..... 15 1/8 INCHES ✓
* HA-22	3-1-58	HELIX CURRENT ..... 200µA (MAX.) ✓ CAPSULE LENGTH ..... 16 5/8 INCHES ✓
HA-23	12-1-58	HEATER VOLTAGE ..... 4.5 TO 6.3 VOLTS ✓ CAPSULE LENGTH ..... 15 7/8 INCHES ✓ CATHODE CURRENT ..... 1.5 MA (MAX.) ✓
* HA-24	3-1-58	CAPSULE LENGTH ..... 14.8 INCHES ✓
* HA-26	3-1-58	CAPSULE LENGTH ..... 14.8 INCHES ✓
* HA-28	3-1-58	CAPSULE LENGTH ..... 17 INCHES ✓
HA-29	1-1-58	CAPSULE LENGTH ..... 17 INCHES ✓ NET WEIGHT ..... 3.6 POUNDS ✓
HA-30	6-1-58	CAPSULE LENGTH ..... 15 1/2 INCHES ✓
HA-31	3-1-58	HEATER CURRENT ..... 1.2 AMPS ✓ CAPSULE LENGTH ..... 15 1/2 INCHES ✓
* HA-34	1-1-58	CAPSULE LENGTH ..... 16 5/8 INCHES ✓
HA-40	3-15-58	COLLECTOR VOLTAGE ..... 300 TO 450 VOLTS ✓ ANODE NO. 1 VOLTAGE ..... 0 TO 10 VOLTS ✓ HEATER VOLTAGE ..... 5.0 TO 6.3 VOLTS ✓ CAPSULE LENGTH ..... 17 1/2 INCHES ✓
HA-44	7-1-58	CAPSULE LENGTH ..... 15 7/8 INCHES ✓
H0-1	2-15-58	CAPSULE LENGTH ..... 15 1/8 INCHES ✓
H0-13	2-15-58	CAPSULE LENGTH ..... 13 5/8 INCHES ✓
PA-3	11-1-57	CAPSULE LENGTH ..... 13 5/8 INCHES ✓
PA-4	6-1-58	CAPSULE LENGTH ..... 14 3/4 INCHES ✓
PA-6	6-1-58	CAPSULE LENGTH ..... 15 1/2 INCHES ✓
BA-1	6-1-57	CAPSULE LENGTH ..... 15 1/8 INCHES ✓
BA-2	6-1-57	CAPSULE LENGTH ..... 13 5/8 INCHES ✓

\* ADDITION TO POWER SUPPLY REQUIREMENTS ARE -- GRID VOLTAGE, . . . 0 TO -50 VOLTS

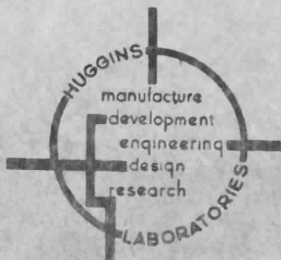

HUGGINS LABORATORIES, INC.  
711 HAMILTON AVENUE, MENLO PARK, CALIFORNIA

February 1, 1958

*typewritten copy from original  
held by Mr. Dain*

TO: All Purchasing Agents, Engineers

Your attention is called to certain changes in performance specifications in some of our products.

1. Backward Wave Oscillators.

a. Standard units, effective the above date, will be specified at 1 mw minimum output over the appropriate band assigned each tube type. This is a change from the former 10 mw minimum output specification. We will in all cases, however, be able to supply tubes meeting customer specifications, as we have done in the past. For example, HO-1 tubes can be supplied to provide 10 mw minimum output over the 2.0 to 4.0 Kmc band, if required. Standard units will be specified at the 1.0 mw minimum level, however. Submit request for quotation of price and delivery on units whose specifications differ from those of our standard units.

b. The standard X-band backward wave oscillator will be given the HO-14 designation. This tube is specified to provide 1 mw minimum output over the 8.2 to 12.4 Kmc band. The former HO-2 type has been discontinued, but will be available for replacement purposes, or for applications requiring a tube having specifications differing from the HO-14 for frequencies in the X-band region.

2. Low Noise Tubes.

A change in specification for small signal gain is effective the above date. All tubes providing either 15 db or 10db maximum noise figure over the appropriate band will provide 25 db minimum small signal gain over that band, rather than the former 30 db. Again, tubes meeting customer specifications which differ from the above can be supplied as in the past.

3. HA-9 and HA-21.

Change in specified minimum power output from 1 watt to 0.5 watt (27 dbm) over the 8.0 to 11.0 Kmc band. Minimum saturation gain is 27 dbm rather than 30 dbm.

4. HA-14.

Specified performance over the 1.0 to 2.0 Kmc band is 11 db maximum noise figure, rather than 10 db. The lower noise figure can be provided, in general, over any portion of the 1.0 to 1.8 Kmc band. Lower specified bandwidth usually results in our being able to supply tubes having lower noise figure, with 8 db being the best optimum value we have observed at a given frequency.

# HUGGINS'

## TRAVELING WAVE TUBES



EASY TO OPERATE AND ADJUST  
HIGH PERFORMANCE  
RELIABLE  
RUGGED

### PERFORMANCE CHARACTERISTICS

#### 1. High Gain

Small Signal Gain is a minimum of 30 to 35 db depending on frequency range.

Saturation Gain for the medium power tubes is at least 30 db so that the tube can be driven to full power output with a milliwatt signal generator.

#### 2. Wide Bandwidth

Most tubes provide rated gain and power output over 2:1 frequency range without readjustment of voltage or current and have useful gain and power output over a much wider frequency range.

#### 3. Stability (Freedom from oscillations)

Spurious low level oscillations have been eliminated. The tubes are stable under short circuit conditions. Total reflections of arbitrary phase can be simultaneously connected to the input and output r.f. cables without oscillation.

#### 4. Low Regeneration

Periodic fluctuations of gain as a function of frequency due to regenerative feedback are held to a minimum. Variations of less than plus or minus 1 db can be expected into a matched load. Gain fluctuations are not excessive with high VSWR loads.

#### 5. Low VSWR

The VSWR measured with the tube not operating is less than 1.7:1 for most tubes. Both the input and output VSWR measured with the tube operating does not differ appreciably from the cold VSWR except at one or two isolated frequencies within the band.

## 6. Holes

Holes in gain and power output as a function of frequency are virtually eliminated.

## 7. Grid Control

All low power tubes have a grid electrode which enables variation of gain and power output over wide ranges with relatively small voltage variation. At least 40 db reduction in gain is provided anywhere within the operating band with 50 volts negative applied to grid. If sufficient negative grid voltage is applied so that the beam current is cut off, the total reduction in output can be as great as 90 to 100 db.

## 8. Vibration Effects

When solenoid and tube are mounted on shock trays such as used in aircraft equipment installations, the effects on operating characteristics are not appreciable with 10 G's vibration at 60 cycles in all directions of vibration.

## 9. Long Life Characteristics

Minimum of 1000 hours for low power tubes.

Minimum of 500 hours for medium power tubes.

### OPERATING CHARACTERISTICS AND ADJUSTMENTS:

1. A minimum number of voltages are required for operation.

Low Power tubes require:

- a. Heater Voltage Supply (6.3 - 7.0 volts A.C.)
- b. Helix and Collector Voltage Supply (same voltage)
- c. Anode Voltage Supply (anode draws practically no current)
- d. Grid Voltage Supply (optional since grid is at cathode potential for full gain)

Medium Power tubes require:

- a. Heater Voltage Supply (7.0 volts A.C.)
- b. Helix Voltage Supply
- c. Collector Voltage Supply (helix voltage plus 150 volts)
- d. Anode Voltage Supply (anode draws no current)

2. Simple Adjustments to Set Tubes into Operation.

Tubes require no RF measurements or adjustments which use a signal generator for setting into operation.

- a. Merely adjust tube position in magnetic field for minimum helix current.
- b. Apply helix voltage given on data sheet with a 1 per cent accuracy meter.
- c. Apply anode voltage for rated current.

### 3. Safety to Operating Personnel

There are no exposed coolers, leads, or terminals which have voltage with respect to ground.

## PHYSICAL CHARACTERISTICS

### 1. Rugged Capsulation

- a. All metal capsule has tube permanently locked in place inside.
- b. Tubes will easily withstand shock of normal handling by unskilled or untrained personnel.
- c. No breakage can result from handling of the unencapsulated tube since tube is permanently locked inside capsule.
- d. All mechanical adjustments on tube are made inside of capsule at the factory.

### 2. Capsule Size

Capsule size of the amplifier tubes is 1.0 inch maximum diameter. This small size allows the tubes to be operated in efficient, small diameter solenoids.

### 3. Input and Output Cables

The tubes are provided with input and output leads consisting of flexible high-temperature 50 ohm coaxial cable. Either BNC or Type N connectors can be provided in most frequency ranges.

## SPECIAL MODIFICATIONS OF TUBES

### 1. Power Lead Filters

Filters can be provided within the tube capsule to prevent RF feedthrough into the tube on the D.C. voltage leads. Filters are necessary in high signal strength areas to eliminate unwanted signals from entering the amplifying channel. Filters are also necessary to prevent oscillations due to stray feedback when high gain tubes are operated in tandem.

Filters provide at least 35 db of dissipative loss in series with each lead going into capsule.



## 2. High Altitude Insulation

Tubes can be specially treated so that they will operated to altitudes of 50,000 feet without corona or arc-over problems.

## 3. Special Gain Characteristics

Tubes with special gain vs. frequency characteristics can be provided.

Special tubes with very low regeneration characteristics can be supplied.

## 4. Medium Power Tube, Grid Modification

The medium power tubes can be provided with control grid electrodes at 2 to 3 db sacrifice in power output. This grid operates positive with respect to the cathode under normal operation and does not have the high control action on gain and power output that is found in the low power tubes.

## SOLENOIDS

1. Compatible solenoids can be supplied for each tube type. These solenoids are designed for minimum weight and size consistent with good engineering practice and operating temperature conditions.

2. Solenoid types are available for:

- a. Aircraft Voltage Ranges (24 - 28 volts D.C.)
- b. Rectification from 110 volt A.C. line (90-100 volts D.C.)
- c. Special Voltage Requirements

3. High Gauss, Air Cooled Solenoids

For tubes that require high magnetic fields and which have collector power to dissipate, solenoids are available which provide air cooling for the collector as well as for the solenoid windings. This is accomplished with one blower mounted on the solenoid which can be supplied either to operate on 24-28 volts D.C. or 110 volts A.C.

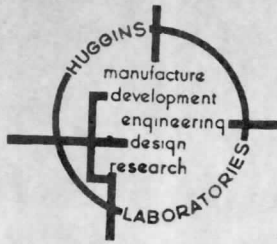

# HUGGINS LABORATORIES, INC.

711 Hamilton Avenue • Menlo Park, California

## D.C. CONNECTOR INFORMATION

THE INFORMATION BELOW GIVES THE ELECTRODE WHICH IS ASSOCIATED WITH THE CORRESPONDING PIN ON THE VARIOUS CONNECTORS WHICH WE ARE ABLE TO SUPPLY WITH OUR AMPLIFIERS AND OSCILLATORS. THE COLOR CODING INDICATED FOR THE LEADS IS STANDARD AND CANNOT BE CHANGED.

CONNECTOR TERMINAL	CONNECTOR M7S	COLOR OF LEAD	CONNECTOR PM6 <sup>1</sup>	COLOR OF LEAD	CONNECTOR PM12 <sup>2</sup>	CONNECTOR M9P <sup>3</sup>	COLOR OF LEAD
A	GRID <sup>4</sup>	YELLOW	NO. CONN.			ANODE NO. 2	YELLOW
B	ANODE	BROWN	ANODE	BROWN	GRID	ANODE NO. 3	BROWN
C	COLLECTOR AND GROUND <sup>5</sup>	GREEN	HELIX	RED	COLLECTOR AND GROUND <sup>5</sup>	COLLECTOR <sup>5</sup>	GREEN
D	HELIX	RED	HEATER-CATHODE	BLACK		HELIX	RED
E	HEATER-CATHODE	BLUE OR BLACK	HEATER	WHITE		HEATER-CATHODE	BLUE
F	HEATER	WHITE	COLLECTOR-GROUND <sup>5</sup>	GREEN	HEATER-CATHODE	HEATER	WHITE
H	CATHODE	ORANGE			HEATER	ANODE NO. 1	ORANGE
J					CATHODE	ANODE NO. 4	BLACK
K						CATHODE	PURPLE
L					HELIX		
N					ANODE		

1 SUPPLIED AS STANDARD CONNECTOR ON BWO AND BWA TUBES AND SOME POWER AMPLIFIERS.

2 SUPPLIED AS STANDARD CONNECTOR ON PERMANENT MAGNET FOCUSED TUBES ATTACHED DIRECTLY TO CAPSULE.

3 SUPPLIED AS STANDARD CONNECTOR ON MEDIUM NOISE AND LOW NOISE TUBES.

4 IN TUBES INTENDED FOR PULSE USE WITH GROUNDED CATHODE, THE GRID LEAD CAN BE SUPPLIED ON A FEMALE BNC CONNECTOR ATTACHED TO THE CAPSULE. NO CONNECTION TO THIS PIN IN NON-GRIDDED TUBES.

5 IN LOW AVERAGE POWER AMPLIFIERS, WHERE GROUNDED CATHODE OPERATION IS DESIRED, THE COLLECTOR CAN BE SUPPLIED ON A SEPARATE WINCHES-TER SMIP CONNECTOR ATTACHED DIRECTLY TO THE CAPSULE.

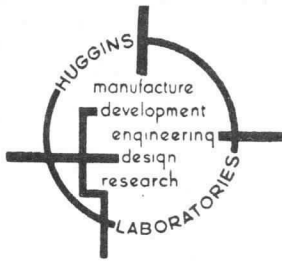

# HUGGINS LABORATORIES, INC.

999 East Arques Avenue · Sunnyvale, California

## SOLENOID - FOCUSED, 10 MW S - BAND AMPLIFIER

### ELECTRICAL CHARACTERISTICS

FREQUENCY RANGE . . . . .	2.0 TO 4.0 KMC
SMALL-SIGNAL GAIN . . . . .	30 DB MIN
SATURATION POWER OUTPUT . . . . .	10 DBM MIN
GAIN AT SATURATION . . . . .	20 DB MIN
VSWR, INPUT AND OUTPUT . . . . .	2:1 MAX

### OPERATING CHARACTERISTICS

ELEMENT	VOLTAGE	% REGULATION	CURRENT
HELIX	400 TO 525 V	--	0.2 MA MAX
COLLECTOR	400 TO 525 V	--	3.5 MA MAX
ANODE	0 TO 350 V	--	0.1 MA MAX
CATHODE	0 V	--	3.5 MA MAX
GRID	0 * V	--	0.1 MA MAX
HEATER	6.3 V	--	1.0 AMP MAX

\* A NEGATIVE VOLTAGE CAN BE APPLIED FOR R - F ATTENUATION

FOCUSING . . . . . SOLENOID, 300 GAUSS

### MECHANICAL CHARACTERISTICS

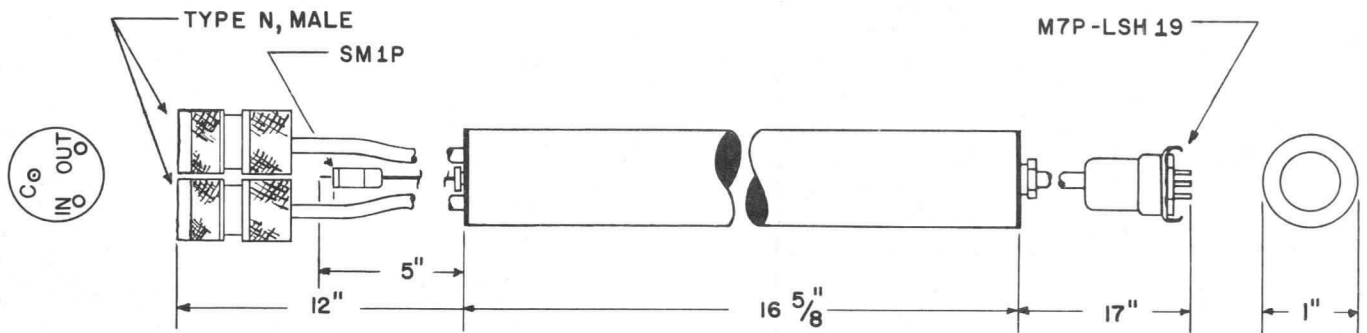

CAPSULE FINISH . . . . .	BLACK ANODIZED
END CAP FINISH . . . . .	BLACK ANODIZED
AUXILIARY COOLING REQUIRED . . . . .	NONE
NET WEIGHT . . . . .	1.0 LB

## TYPICAL OPERATING CHARACTERISTICS

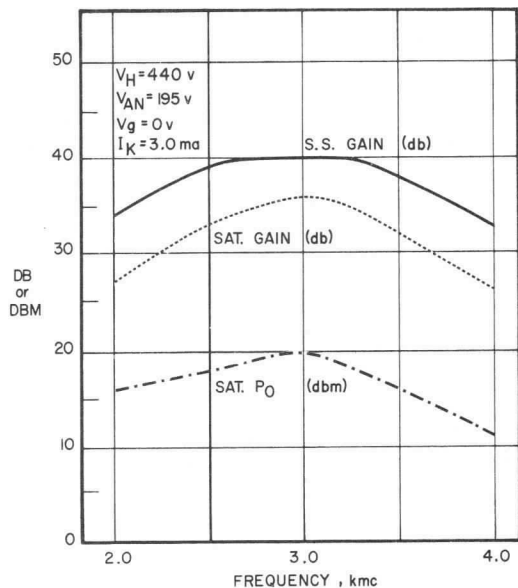

GAIN AND POWER OUTPUT

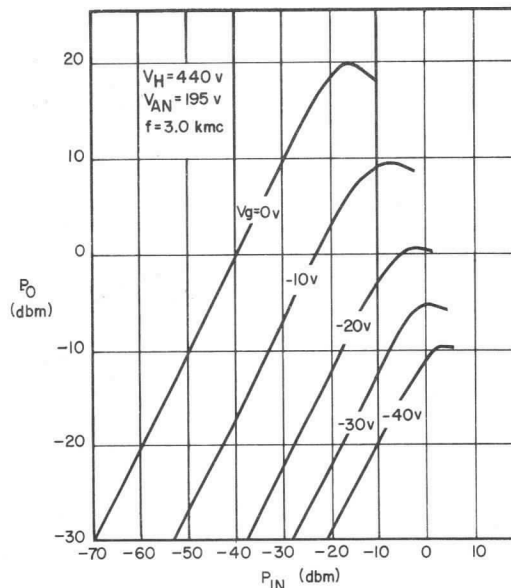

TRANSFER CHARACTERISTICS

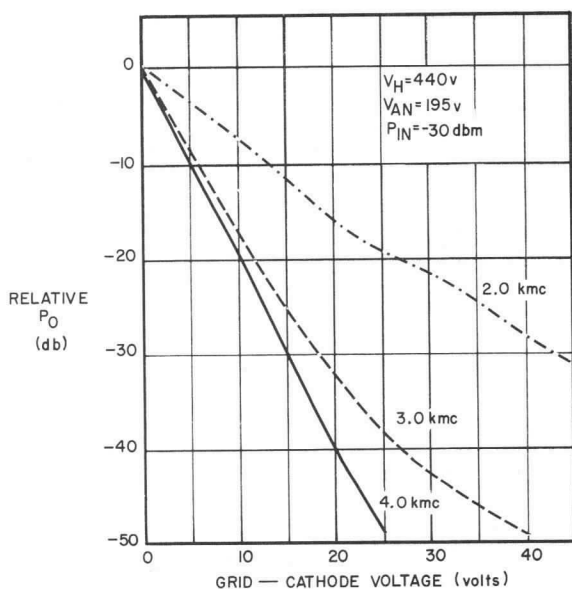

GRID CONTROL

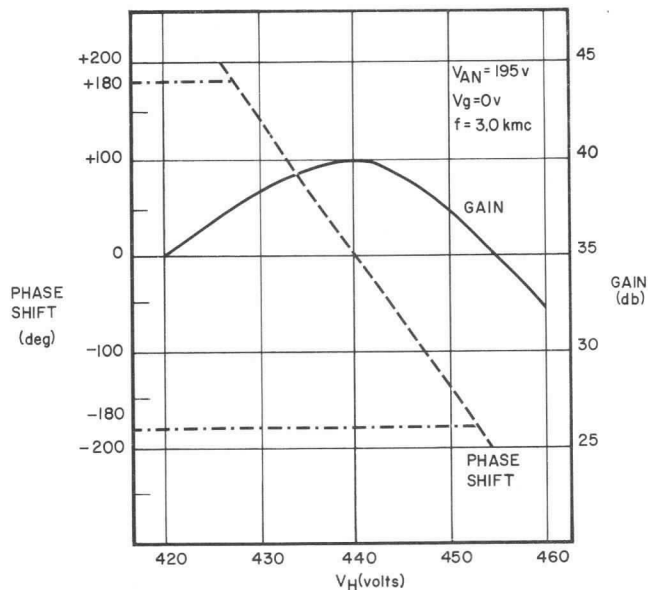

PHASE SHIFT AND GAIN vs HELIX VOLTAGE (small signal)



# HUGGINS LABORATORIES, INC.

711 Hamilton Avenue • Menlo Park, California

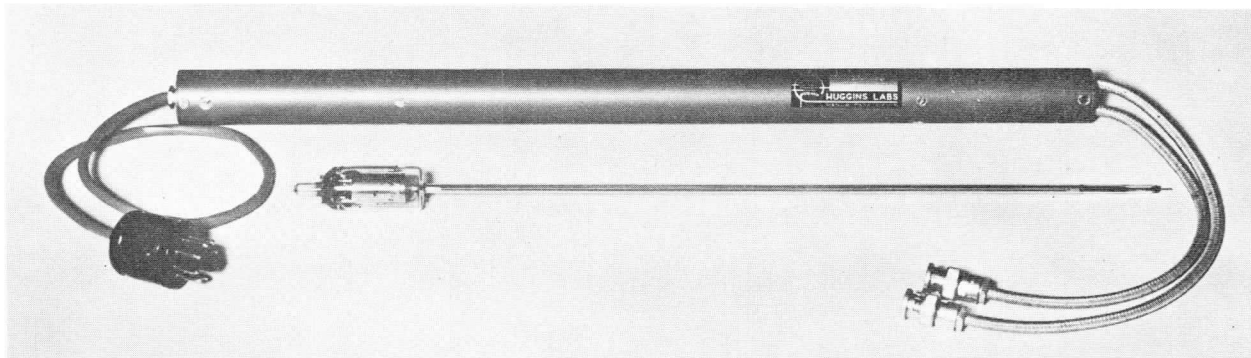

## LOW POWER - HIGH GAIN AMPLIFIER

### GENERAL CHARACTERISTICS

#### ELECTRICAL

FREQUENCY RANGE	2.0 - 4.0 KMc/s
SMALL SIGNAL GAIN	30 db (Min.)
POWER OUTPUT	10 dbm (Min.)
GAIN AT MAXIMUM POWER OUTPUT	20 db (Min.)
NOISE FIGURE	20 db (Max.)

#### OPERATING

HELIX AND COLLECTOR VOLTAGE	450 Volts
CATHODE CURRENT	3.5 Ma (Max.)
ANODE VOLTAGE	250 - 400 Volts
ANODE CURRENT	50 $\mu$ a (Max.)
GRID VOLTAGE	0 to -50 Volts
GRID CURRENT	20 $\mu$ a (Max.)
HEATER VOLTAGE	6.3 Volts
HEATER CURRENT	0.7 Amps.
MAGNETIC FIELD	300 Gauss

#### MECHANICAL

RF CONNECTORS	BNC Male UG-88C/U
DC CONNECTOR	Octal or Winchester Plug
CAPSULE LENGTH	16 3/4 In. (M7P)
CAPSULE DIAMETER	1.0 In.
NET WEIGHT	1 lb.
SHIPPING WEIGHT	11 lbs.



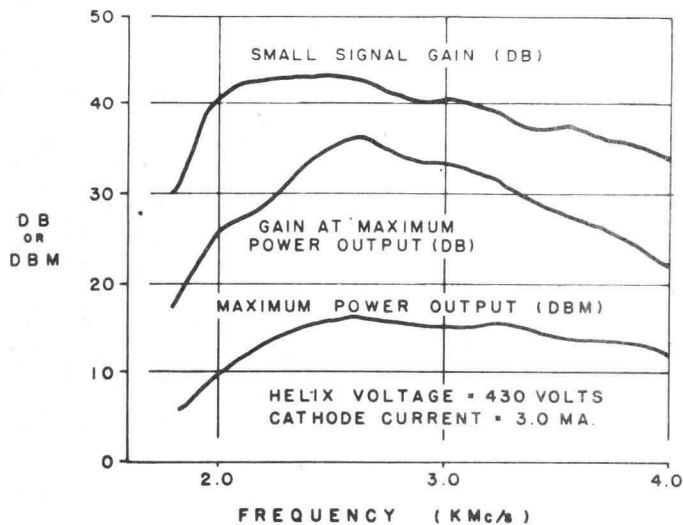

GAIN and POWER OUTPUT

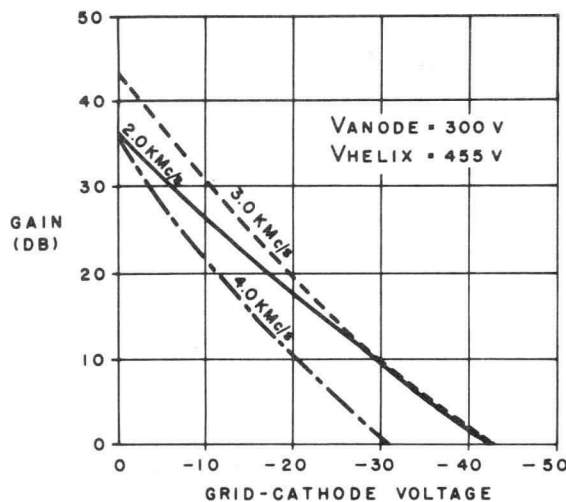

GRID CONTROL

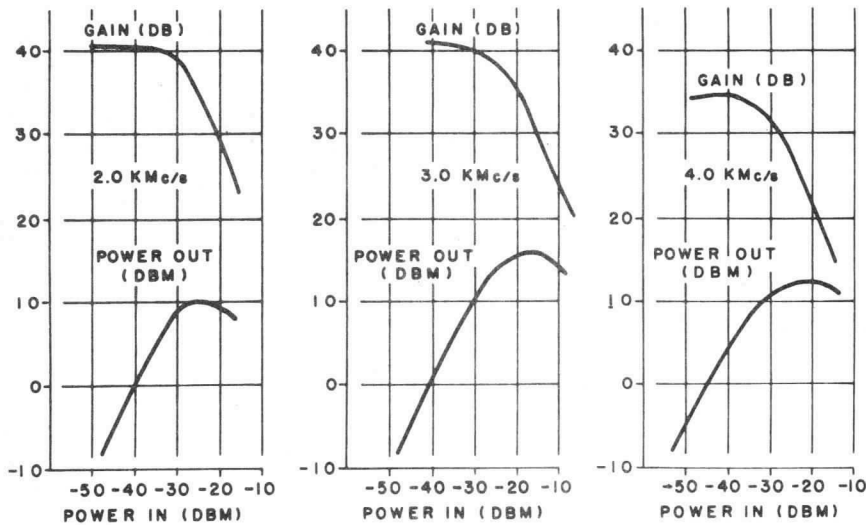

POWER OUTPUT

VS

POWER INPUT

DIMENSIONS

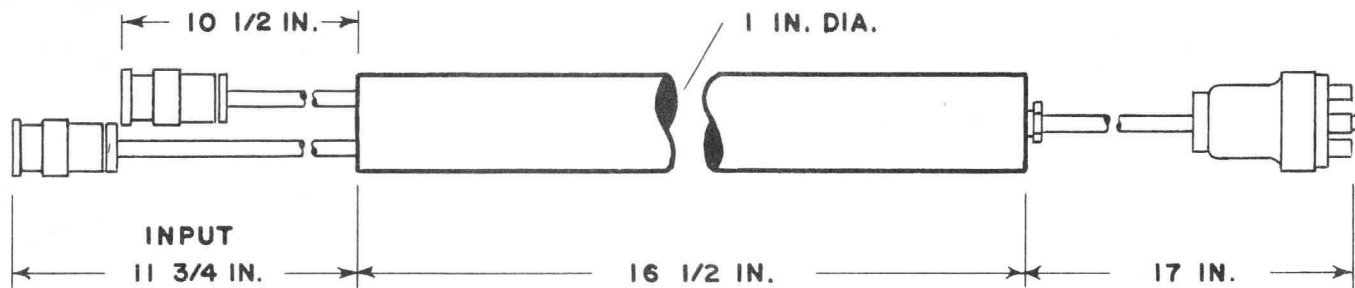

Note: Other lead lengths or connectors may be specified.

SOLENOID

See Solenoid Section for appropriate unit and specifications.

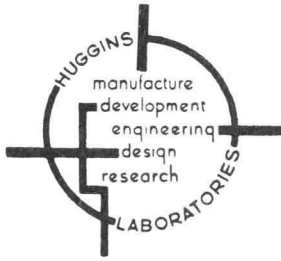

**HUGGINS LABORATORIES, INC.**  
 999 East Arques Avenue · Sunnyvale, California

**SOLENOID - FOCUSED, 1 WATT S - BAND AMPLIFIER**

**ELECTRICAL CHARACTERISTICS**

FREQUENCY RANGE . . . . .	2.0 TO 4.0 KMC
SMALL-SIGNAL GAIN . . . . .	30 DB MIN
SATURATION POWER OUTPUT . . . . .	30 DBM MIN
GAIN AT 30 DBM POWER OUTPUT . . . . .	27 DB MIN
VSWR, INPUT AND OUTPUT . . . . .	2:1 MAX

**OPERATING CHARACTERISTICS**

ELEMENT	VOLTAGE	% REGULATION	CURRENT
HELIX	800 TO 1100 V	--	0.3 MA MAX
COLLECTOR	800 TO 1100 V	--	25.0 MA MAX
ANODE	0 TO 450 V	--	0.1 MA MAX
CATHODE	0 V	--	25.0 MA MAX
GRID <sup>1</sup>	0 *	--	0.1 MA MAX
HEATER	7.0 V	--	1.2 AMP MAX

\* A NEGATIVE VOLTAGE CAN BE APPLIED FOR R - F ATTENUATION.

FOCUSING. . . . . SOLENOID, 600 GAUSS

**MECHANICAL CHARACTERISTICS**

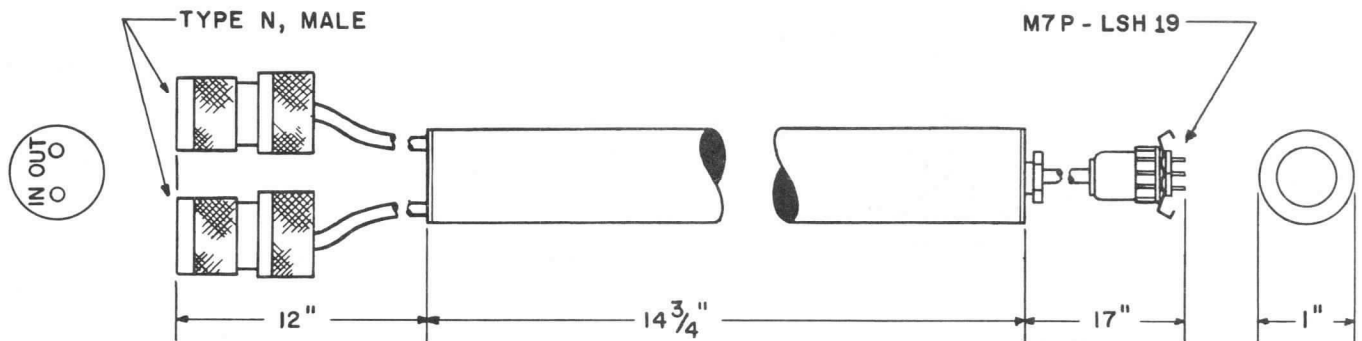

CAPSULE FINISH . . . . .	CHROME
END CAP FINISH . . . . .	CHROME
AUXILIARY COOLING REQUIRED . . . . .	SOLENOID BLOWER
NET WEIGHT . . . . .	1.0 LB

<sup>1</sup> FOR TUBE WITH GRID CONNECTED INTERNALLY TO CATHODE, ORDER HA - 2J.

## TYPICAL OPERATING CHARACTERISTICS

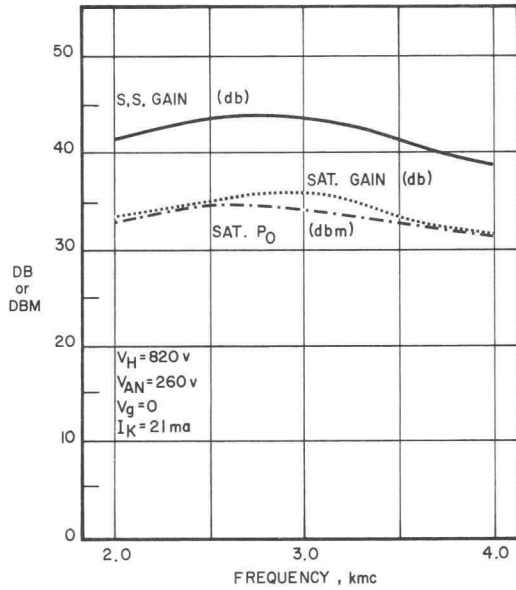

GAIN AND POWER OUTPUT

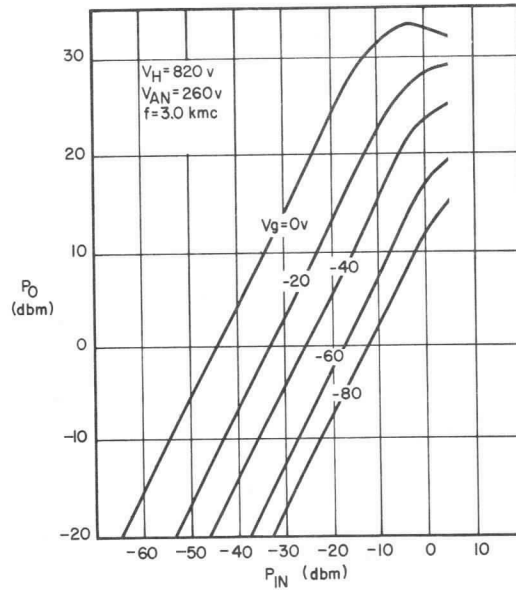

TRANSFER CHARACTERISTICS

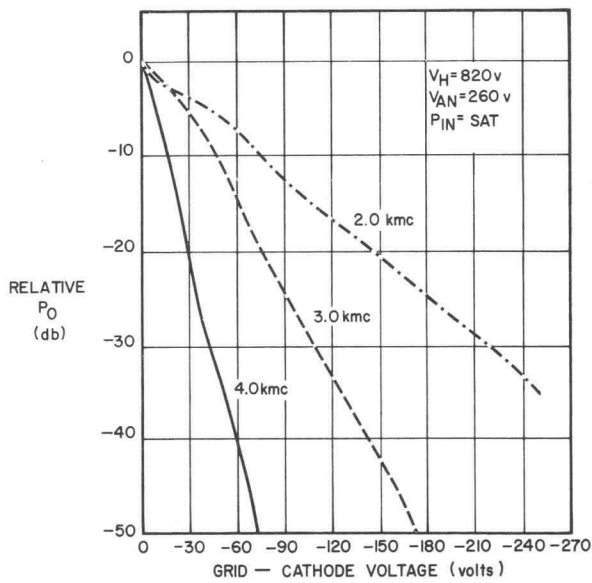

GRID CONTROL

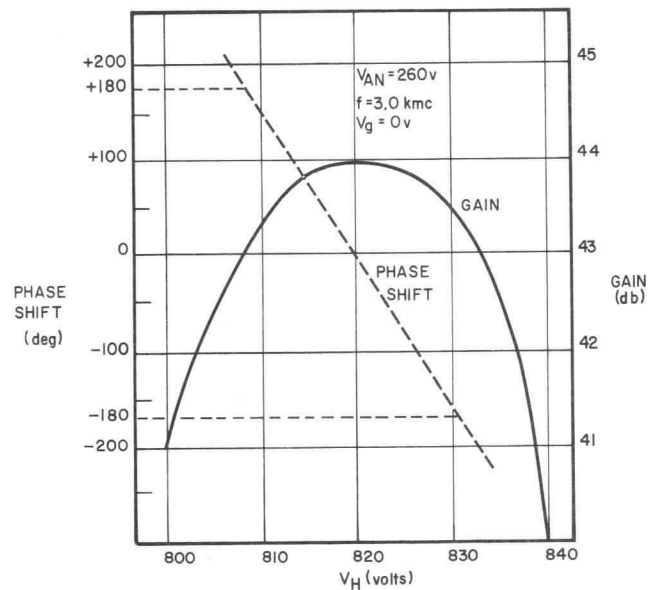

PHASE SHIFT AND GAIN vs HELIX VOLTAGE (small signal)



# HUGGINS LABORATORIES, INC.

711 Hamilton Avenue • Menlo Park, California

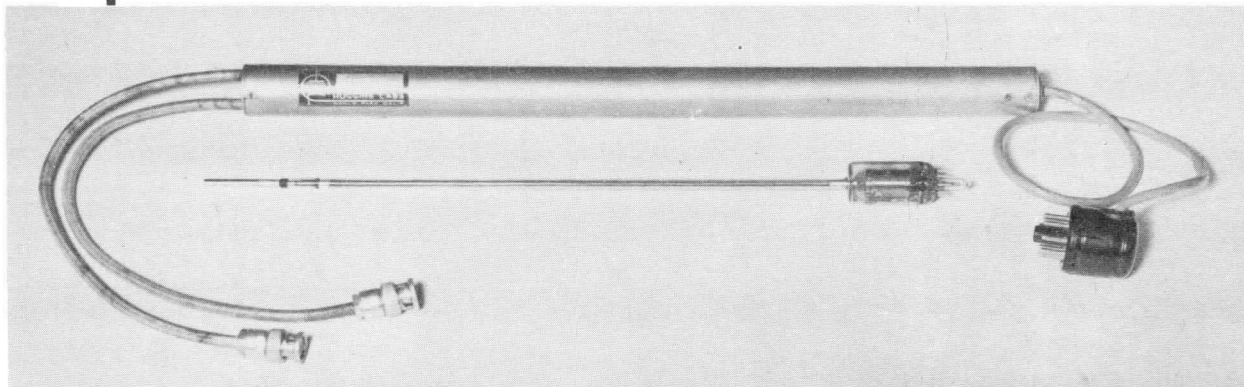

## MEDIUM POWER AMPLIFIER

### GENERAL CHARACTERISTICS

#### ELECTRICAL

FREQUENCY RANGE . . . . .	2.0 - 4.0 KMc/s
SMALL SIGNAL GAIN . . . . .	34 db (Min.)
POWER OUTPUT. . . . .	30 dbm (Min.)
GAIN AT MAXIMUM POWER OUTPUT. . . . .	30 db (Min.)

#### OPERATING

HELIX VOLTAGE . . . . .	950 Volts
COLLECTOR VOLTAGE (Approx.) . . . . .	1050 Volts
CATHODE CURRENT . . . . .	25 Ma.
ANODE VOLTAGE . . . . .	400 Volts (Max.)
ANODE CURRENT . . . . .	50 ua (Max.)
HEATER VOLTAGE. . . . .	7.0 Volts
HEATER CURRENT. . . . .	0.8 Amps.
MAGNETIC FIELD. . . . .	600 Gauss

#### MECHANICAL

RF CONNECTORS . . . . .	BNC Male UG-88C/U
DC CONNECTOR. . . . .	Octal or Winchester Plug (M7P)
CAPSULE LENGTH. . . . .	14 3/4 In.
CAPSULE DIAMETER. . . . .	1.0 In.
NET WEIGHT. . . . .	1 1/4 lbs.
SHIPPING WEIGHT . . . . .	11 1/4 lbs.

## GAIN and POWER OUTPUT

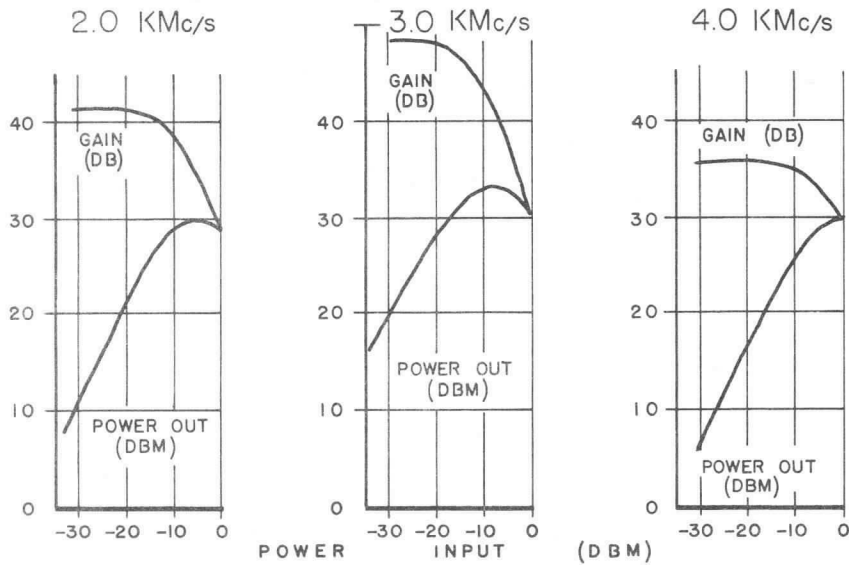
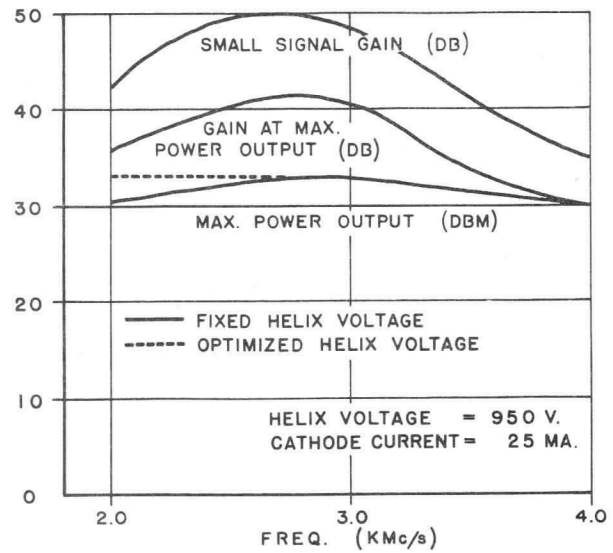

## POWER OUTPUT vs POWER INPUT

## DIMENSIONS

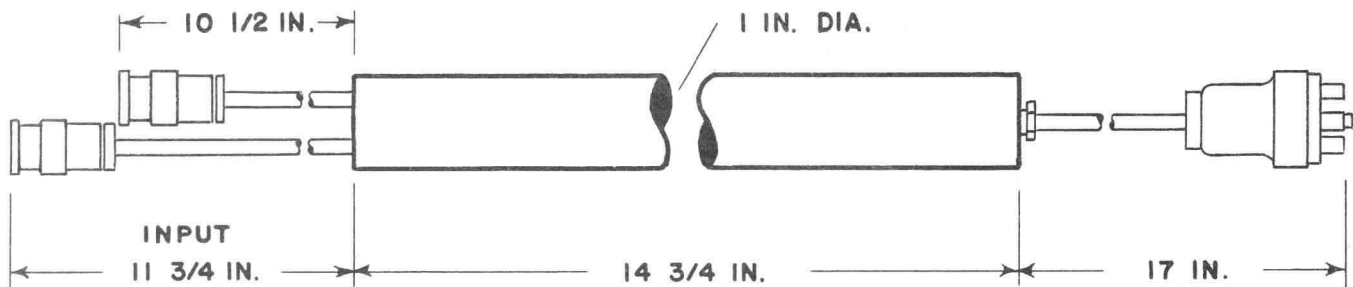

Note: Other lead lengths or connectors may be specified.

## SOLENOID

See Solenoid Section for appropriate unit and specifications.



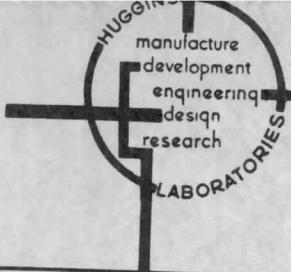

HUGGINS LABORATORIES  
MENLO PARK CALIFORNIA

HA-3

## FORWARD WAVE C-BAND AMPLIFIER

THIS AMPLIFIER IS FURNISHED FOR REPLACEMENT PURPOSES ONLY, AND HAS BEEN SUPERCEDED BY THE HA-26. THE ONLY DIFFERENCE BETWEEN THE TWO TUBES IS IN CAPSULE LENGTH, WHICH ARE:

TUBE TYPE	CAPSULE LENGTH, INCHES
HA-3	13 3/4
HA-26	14 3/4



HUGGINS LABORATORIES, INC.

711 Hamilton Avenue • Menlo Park, California

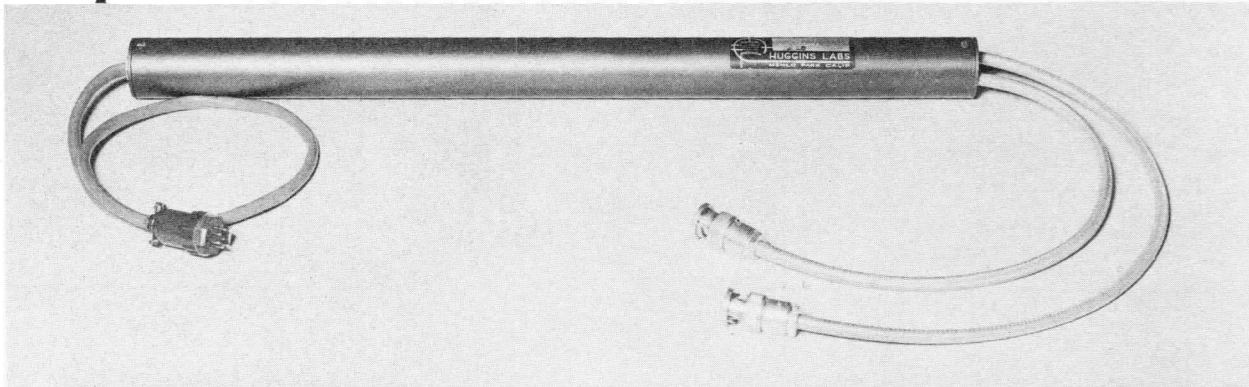

LOW POWER - HIGH GAIN  
TRAVELING-WAVE TUBE AMPLIFIER

GENERAL CHARACTERISTICS

ELECTRICAL

FREQUENCY RANGE . . . . . 4.0 - 8.0 KMc/s  
 SMALL SIGNAL GAIN . . . . . 30 db (Min)  
 POWER OUTPUT. . . . . 10 dbm (Min)

OPERATING

HELIX VOLTAGE . . . . . 700 Volts  
 COLLECTOR VOLTAGE (Approx.) . . . 700 Volts  
 CATHODE CURRENT . . . . . 2.0 Ma.  
 ANODE VOLTAGE . . . . . 350 - 550 Volts  
 ANODE CURRENT . . . . . 50 ua  
 HEATER VOLTAGE. . . . . 6.3 Volts  
 HEATER CURRENT. . . . . 0.75 Amps.  
 MAGNETIC FIELD. . . . . 300 Gauss

MECHANICAL

RF CONNECTORS . . . . . BNC Male UG-88C/U  
 DC CONNECTOR. . . . . Octal or Winchester Plug  
 CAPSULE LENGTH. . . . . 13 3/4 Inches (M7P)  
 CAPSULE DIAMETER. . . . . 1 Inch  
 NET WEIGHT. . . . . 1 lb.  
 SHIPPING WEIGHT . . . . . 13 lbs.

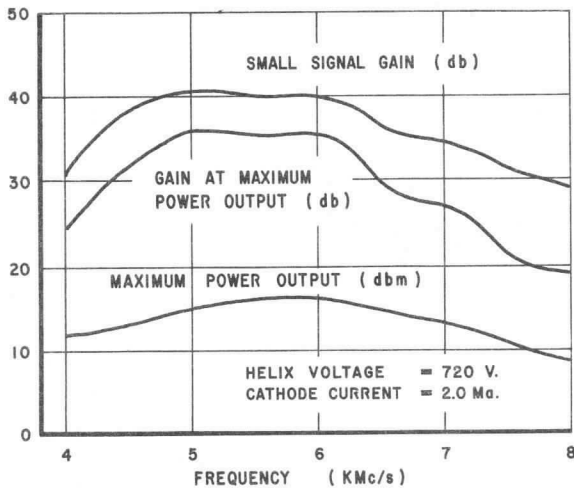

**GAIN and POWER OUTPUT**

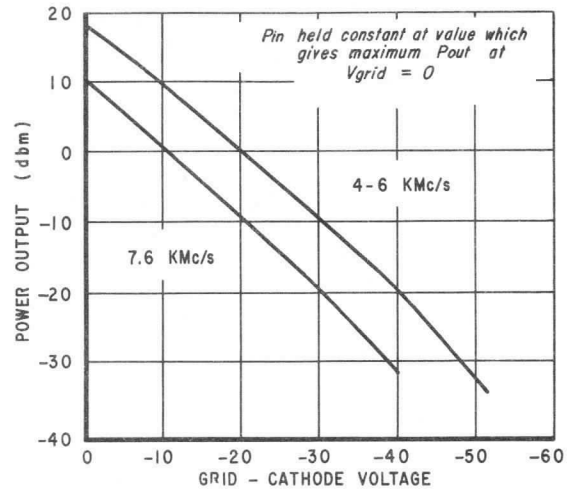

**GRID CONTROL**

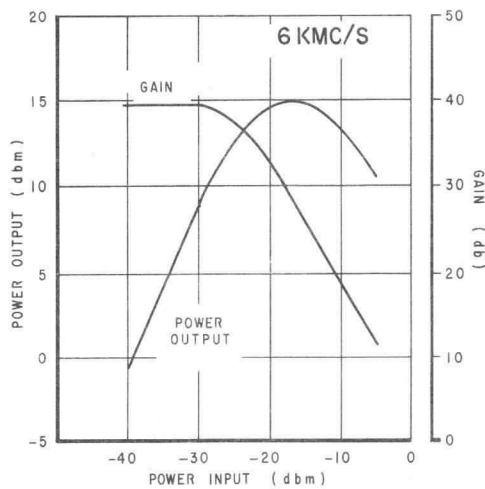

**POWER OUTPUT  
vs  
POWER INPUT**

## DIMENSIONS

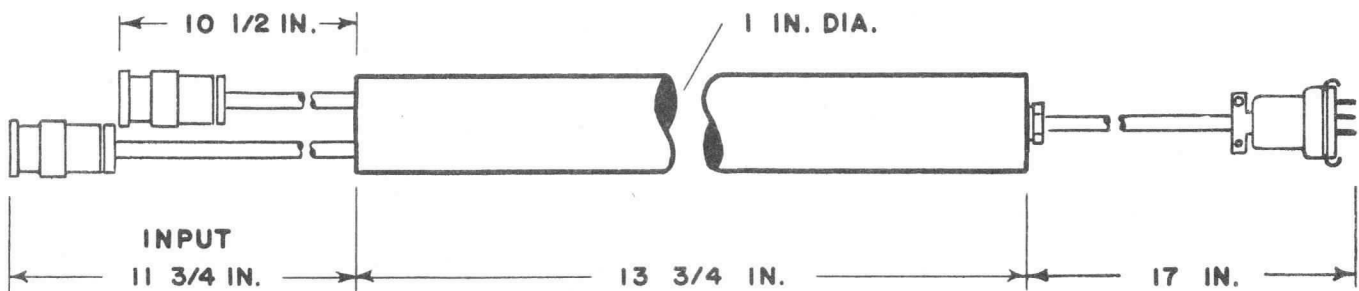

Note: Other lead lengths or connectors may be specified.

## SOLENOID

See Solenoid Section for appropriate unit and specifications.

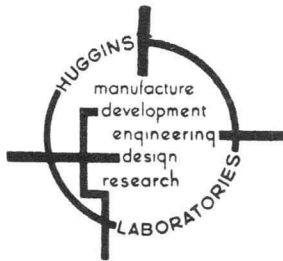

# HUGGINS LABORATORIES, INC.

999 East Arques Avenue · Sunnyvale, California

## SOLENOID - FOCUSED, 10 MW X - BAND AMPLIFIER

### ELECTRICAL CHARACTERISTICS

FREQUENCY RANGE . . . . .	8.0 TO 12.4 KMC
SMALL-SIGNAL GAIN . . . . .	30 DB MIN
SATURATION POWER OUTPUT . . . . .	10 DBM MIN
GAIN AT SATURATION . . . . .	20 DB MIN
VSWR, INPUT AND OUTPUT . . . . .	2:1 MAX

### OPERATING CHARACTERISTICS

ELEMENT	VOLTAGE	% REGULATION	CURRENT
HELIX	1100 TO 1300 V	--	0.2 MA MAX
COLLECTOR	1100 TO 1300 V	--	2.5 MA MAX
ANODE	0 TO 450 V	--	0.1 MA MAX
CATHODE	0 V	--	2.5 MA MAX
GRID	0 * V	--	0.1 MA MAX
HEATER	6.3 OR 7.0 V	--	1.2 AMP MAX

\* A NEGATIVE VOLTAGE CAN BE APPLIED FOR R - F ATTENUATION .

FOCUSING . . . . . SOLENOID, 400 GAUSS

### MECHANICAL CHARACTERISTICS

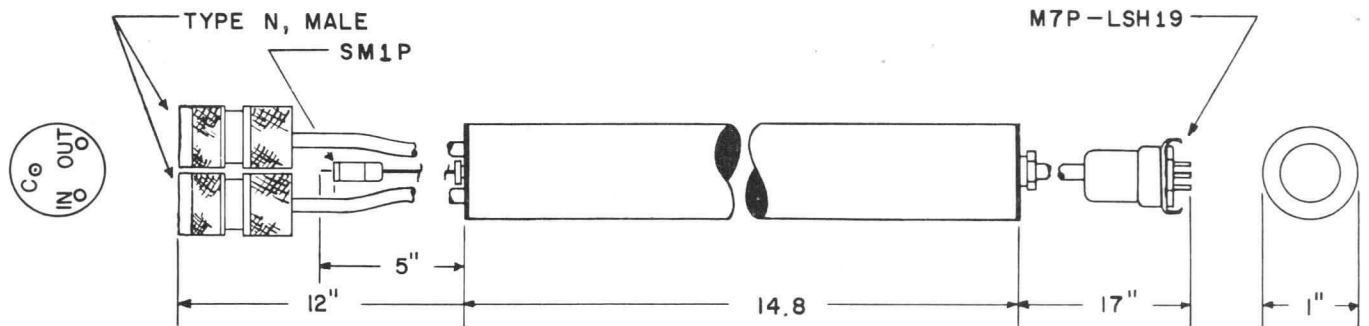

CAPSULE FINISH . . . . .	BLACK ANODIZED
END CAP FINISH . . . . .	BLACK ANODIZED
AUXILIARY COOLING REQUIRED . . . . .	NONE
NET WEIGHT . . . . .	1.0 LB

## TYPICAL OPERATING CHARACTERISTICS

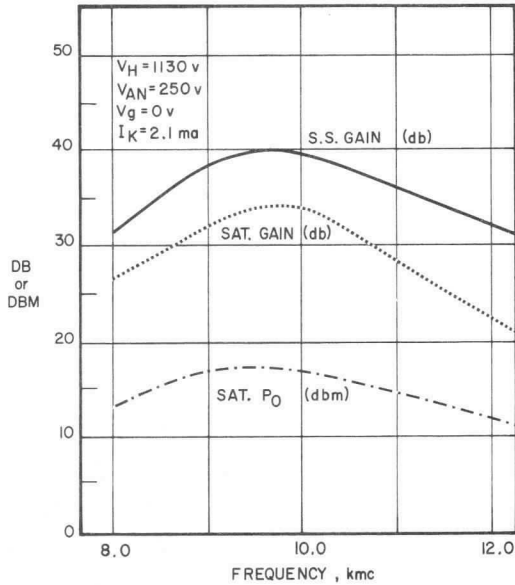

GAIN AND POWER OUTPUT

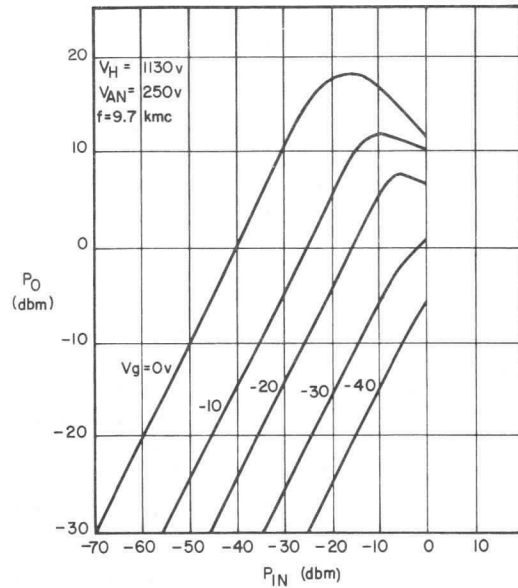

TRANSFER CHARACTERISTICS

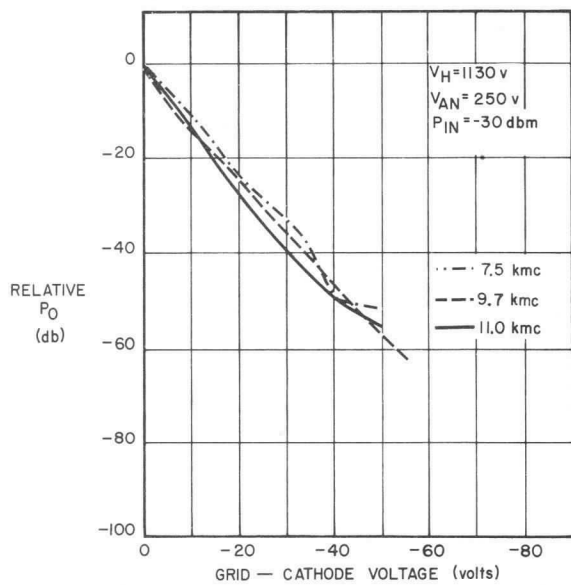

GRID CONTROL

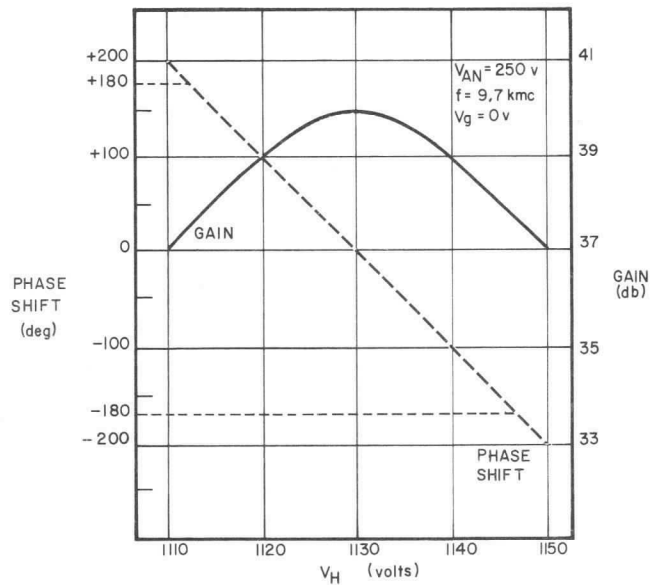

PHASE SHIFT AND GAIN vs HELIX VOLTAGE (small signal)



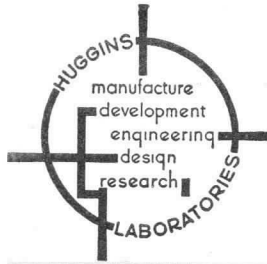

HUGGINS LABORATORIES, INC.  
 711 Hamilton Avenue • Menlo Park, California

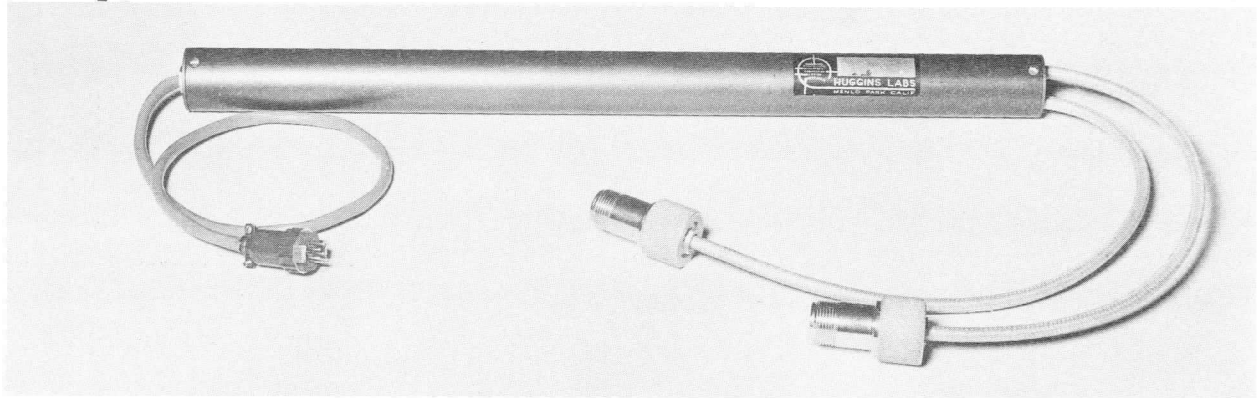

LOW POWER - HIGH GAIN  
 TRAVELING-WAVE AMPLIFIER TUBE

GENERAL CHARACTERISTICS

ELECTRICAL

FREQUENCY RANGE . . . . .	7.0 - 14.0 KMc/s
SMALL SIGNAL GAIN . . . . .	30 db (Min) (7-12 KMc/s)
SMALL SIGNAL GAIN . . . . .	20 db (Min) (12-14 KMc/s)
POWER OUTPUT . . . . .	7.5 dbm (Min) (7-12.4 KMc/s)
VSWR (INPUT AND OUTPUT) . . . . .	2:1 Maximum

OPERATING

HELIX AND COLLECTOR VOLTAGE . . . . .	1150 Volts
CATHODE CURRENT . . . . .	1.5 Ma.
ANODE VOLTAGE . . . . .	600 - 800 Volts
ANODE CURRENT . . . . .	50 ua. (Max)
GRID VOLTAGE . . . . .	0 to -50 Volts
GRID CURRENT . . . . .	20 ua. (Max)
HEATER VOLTAGE . . . . .	7.0 Volts
HEATER CURRENT . . . . .	0.7 Amps.
MAGNETIC FIELD . . . . .	430 Gauss

MECHANICAL

RF CONNECTORS . . . . .	Type N Female
DC CONNECTORS . . . . .	Winchester Plug M7P*
CAPSULE LENGTH . . . . .	13.8 Inches
CAPSULE DIAMETER . . . . .	1.0 Inch
NET WEIGHT . . . . .	1 lb.
SHIPPING WEIGHT . . . . .	11 lbs.

\* Supplied with mating receptacle.

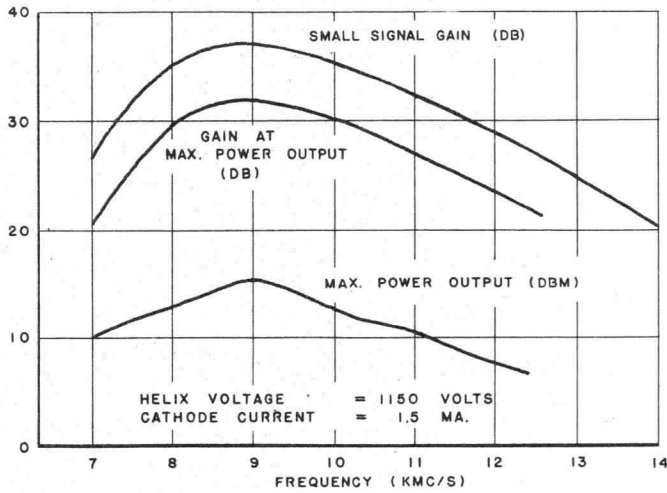

**GAIN and POWER OUTPUT**

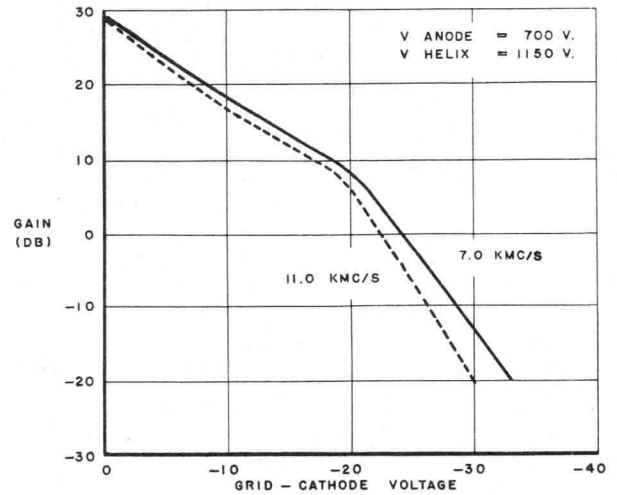

**GRID CONTROL**

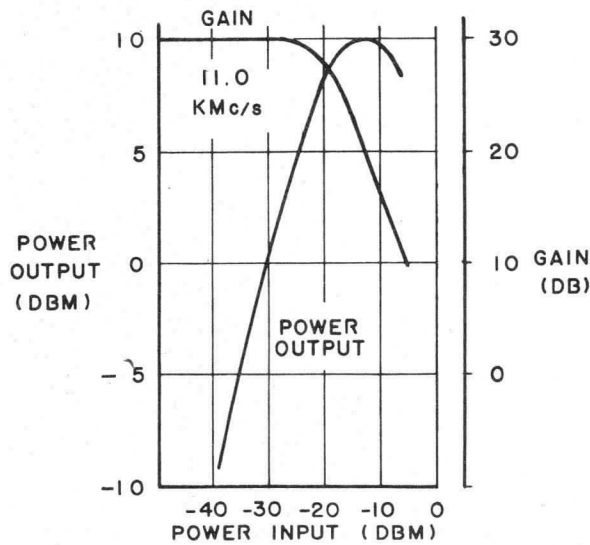

**POWER OUTPUT  
VS  
POWER INPUT**

## DIMENSIONS

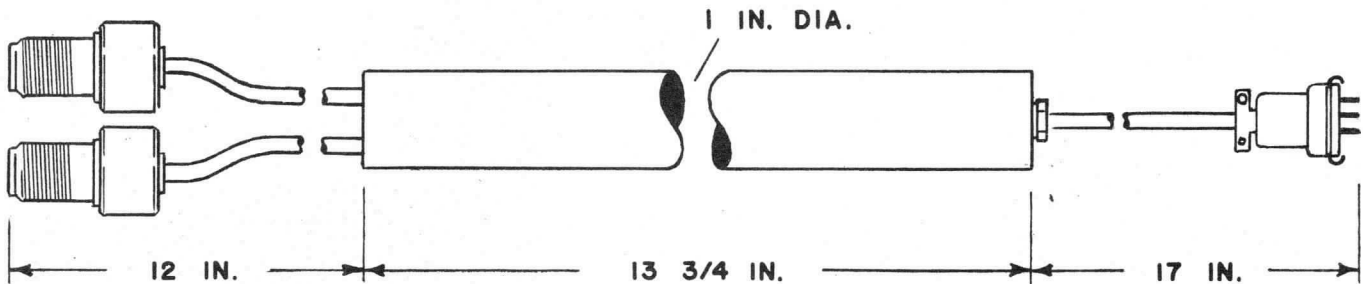

NOTE: Other lead lengths or connectors may be specified.

## SOLENOID

See Solenoid Section for appropriate unit and specifications.



**HUGGINS LABORATORIES, INC.**  
 711 Hamilton Avenue • Menlo Park, California

TENTATIVE DATA

WIDEBAND TRAVELING WAVE TUBE AMPLIFIER

**ELECTRICAL CHARACTERISTICS**

FREQUENCY RANGE.....	1.0 TO 2.0 KMC
SMALL SIGNAL GAIN.....	30 DB (MIN.)
POWER OUTPUT.....	10 DBM (MIN.)

**POWER SUPPLY REQUIREMENTS<sup>1</sup>**

HELIX VOLTAGE.....	180 TO 220 VOLTS
COLLECTOR VOLTAGE.....	330 TO 370 VOLTS
CATHODE CURRENT.....	3.5 MA (MAX.)
HELIX CURRENT.....	200 μA (MAX.)
ANODE VOLTAGE <sup>2</sup> .....	0 TO 150 VOLTS
GRID VOLTAGE.....	0 TO +5 VOLTS
HEATER VOLTAGE.....	6.3 VOLTS
HEATER CURRENT.....	1.3 0.5 AMPS <i>max</i>
MAGNETIC FIELD.....	400 GAUSS

**MECHANICAL CHARACTERISTICS**

RF CONNECTORS.....	TYPE N MALE
DC CONNECTOR.....	WINCHESTER PLUG M7MP*
CAPSULE LENGTH.....	15 5/8 INCHES
CAPSULE DIAMETER.....	1.0 INCH
NET WEIGHT.....	1.0 POUND

\* SUPPLIED WITH MATING CONNECTOR.

<sup>1</sup> ALL DC VOLTAGES MEASURED WITH RESPECT TO CATHODE. COLLECTOR IS INSULATED AND THUS ANY ELECTRODE CAN BE OPERATED AT GROUND POTENTIAL.

<sup>2</sup> THE ANODE VOLTAGE SUPPLY MUST COVER THE RANGE 0 TO 150 VOLTS FOR INITIAL FOCUSING PURPOSES.

# PERFORMANCE

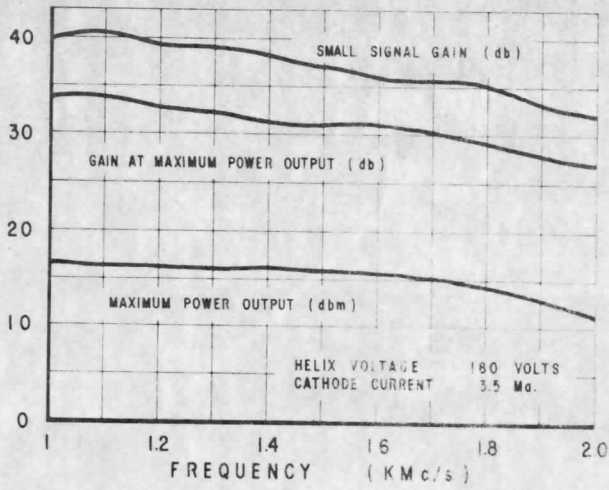

GAIN and POWER OUTPUT

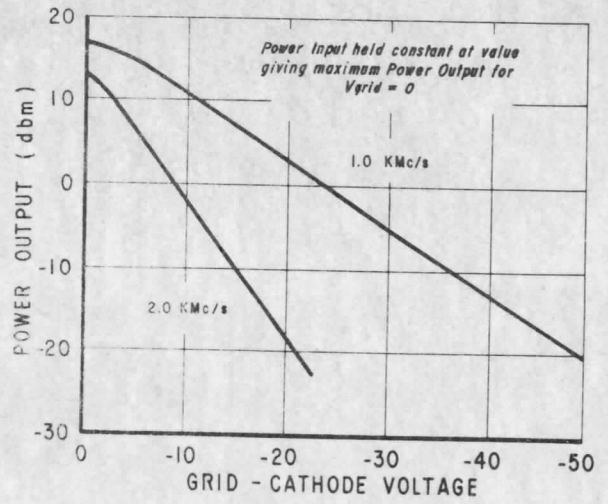

GRID CONTROL

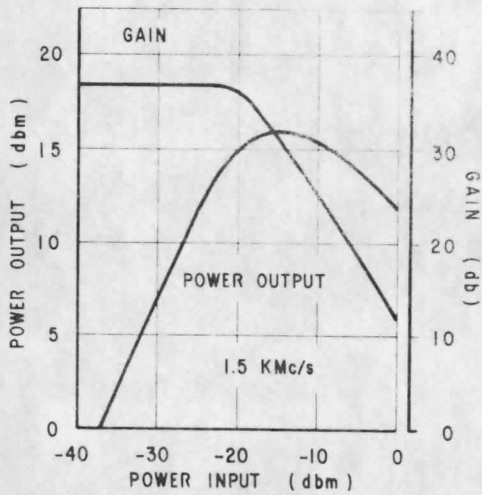

POWER OUTPUT  
vs  
POWER INPUT

# DIMENSIONS

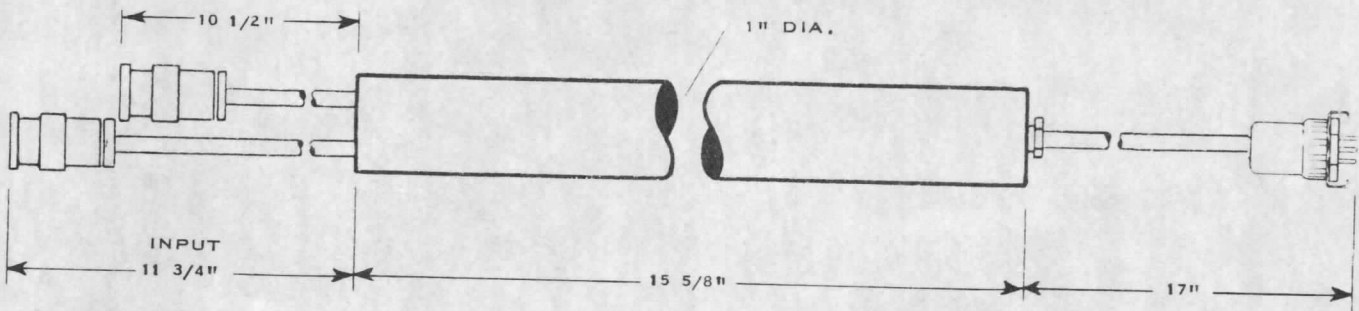

NOTE: OTHER LEAD LENGTHS OR CONNECTORS MAY BE SPECIFIED.

SOLENOID

SEE SOLENOID CHARTS FOR APPROPRIATE UNIT AND SPECIFICATIONS.

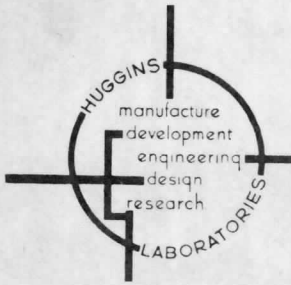

# HUGGINS LABORATORIES, INC.

711 Hamilton Avenue • Menlo Park, California

## TENTATIVE DATA

### MEDIUM POWER C-BAND TRAVELING WAVE TUBE AMPLIFIER

#### ELECTRICAL CHARACTERISTICS

FREQUENCY RANGE..... 4.0 TO 8.0 KMC  
 SMALL SIGNAL GAIN..... 30 DB (MIN.)  
 POWER OUTPUT..... 30 DBM (MIN.)  
 (LOAD VSWR <2:1) OPTIMIZED HELIX VOLTAGE  
 30 DBM (MIN.)  
 BROADBAND... 4.5 TO 7.5 KMC  
 OR 4.0 TO 5.3 KMC  
 OR 5.3 TO 8.3 KMC  
 27 DBM (MIN.)  
 BROADBAND... 4.0 TO 8.0 KMC  
 GAIN AT MAXIMUM POWER OUTPUT... 27 DB (MIN.)

#### POWER SUPPLY REQUIREMENTS<sup>1</sup>

HELIX AND COLLECTOR VOLTAGE..... 1200 TO 1500 VOLTS  
 CATHODE CURRENT..... 15 MA  
 HELIX CURRENT..... 0.5 MA (MAX.)  
 ANODE VOLTAGE<sup>2</sup>..... 700 VOLTS (MAX.)  
 ANODE CURRENT..... 50 μA (MAX.)  
 HEATER VOLTAGE..... 7.0 VOLTS  
 HEATER CURRENT..... 1.3 AMPS (MAX.)  
 MAGNETIC FIELD..... 1100 GAUSS

#### MECHANICAL CHARACTERISTICS

RF CONNECTOR..... TYPE N MALE  
 DC CONNECTOR..... WINCHESTER M7P\*  
 CAPSULE LENGTH..... 13 5/8 INCHES  
 CAPSULE DIAMETER..... 1.0 INCH  
 NET WEIGHT..... 1.0 POUND  
 SHIPPING WEIGHT..... 11 POUNDS

\* SUPPLIED WITH MATING CONNECTOR.

1. ALL DC VOLTAGES MEASURED WITH RESPECT TO CATHODE. COLLECTOR IS GROUNDED TO CAPSULE AND MUST BE OPERATED AT GROUND POTENTIAL.

2. ANODE VOLTAGE RANGE FOR RATED BEAM CURRENT IS 250 TO 700 VOLTS. ANODE SUPPLY MUST BE ADJUSTABLE FROM ZERO VOLTS FOR INITIAL FOCUSING PURPOSES.



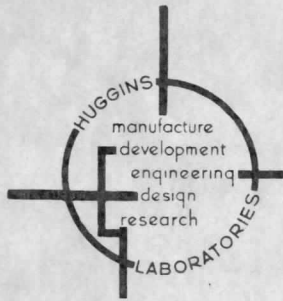

# HUGGINS LABORATORIES, INC.

711 Hamilton Avenue • Menlo Park, California

## TENTATIVE DATA

### WIDEBAND TRAVELING-WAVE TUBE AMPLIFIER

#### ELECTRICAL CHARACTERISTICS

FREQUENCY RANGE.....	0.5 TO 1.0 KMC
SMALL SIGNAL GAIN.....	30 DB ( MIN. )
POWER OUTPUT.....	.10 DBM ( MIN. )

#### POWER SUPPLY REQUIREMENTS<sup>1</sup>

HELIX VOLTAGE.....	90 TO 120 VOLTS
COLLECTOR VOLTAGE.....	140 TO 270 VOLTS
CATHODE CURRENT.....	3.5 MA ( MAX. )
HELIX CURRENT.....	200 $\mu$ A ( MAX. )
ANODE VOLTAGE <sup>2</sup> .....	0 TO 90 VOLTS
GRID VOLTAGE.....	-50 TO +5 VOLTS
HEATER VOLTAGE.....	6.3 VOLTS
HEATER CURRENT.....	1.4 AMPS
MAGNETIC FIELD.....	300 GAUSS

#### MECHANICAL CHARACTERISTICS

RF CONNECTORS.....	TYPE N MALE
DC CONNECTOR.....	WINCHESTER M7MP*
CAPSULE LENGTH.....	.16 3/8 INCHES
CAPSULE DIAMETER.....	.1 5/16 INCHES
NET WEIGHT.....	2.0 POUNDS

\* SUPPLIED WITH MATING CONNECTOR.

1. ALL DC VOLTAGES MEASURED WITH RESPECT TO CATHODE. COLLECTOR IS INSULATED AND THUS ANY ELECTRODE CAN BE OPERATED AT GROUND POTENTIAL.
2. THE ANODE VOLTAGE SUPPLY MUST COVER THE RANGE 0 TO 90 VOLTS FOR INITIAL FOCUSING PURPOSES.

# PERFORMANCE

## GAIN and POWER OUTPUT

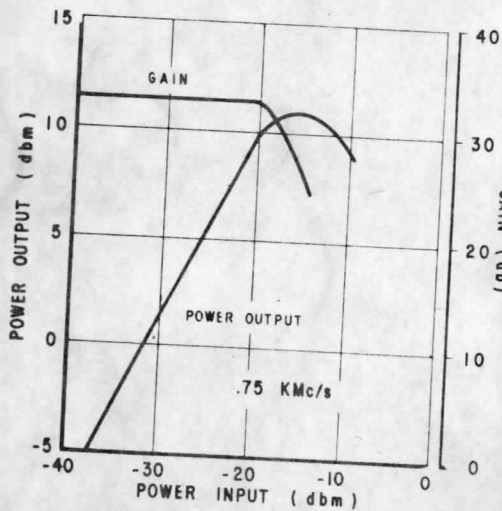
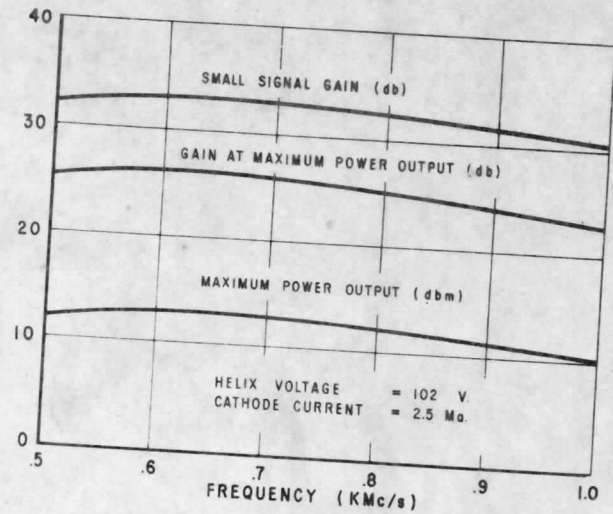

## POWER OUTPUT vs POWER INPUT

# DIMENSIONS

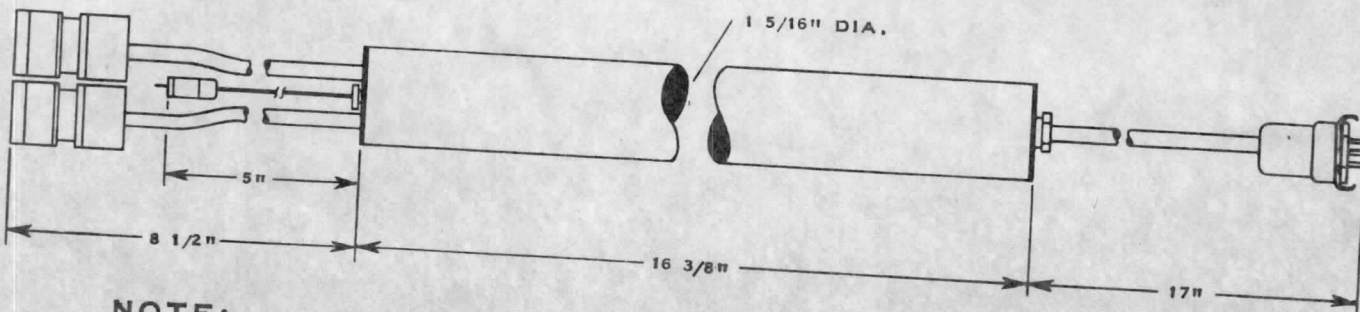

NOTE: OTHER LEAD LENGTHS OR CONNECTORS MAY BE SPECIFIED.

## SOLENOID

SEE SOLENOID CHARTS FOR APPROPRIATE UNIT AND SPECIFICATIONS.

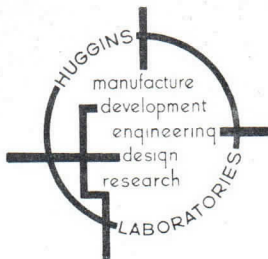

# HUGGINS LABORATORIES, INC.

999 East Arques Avenue · Sunnyvale, California  
 REgent 6-9330 TWX Sunnyvale, Calif. 116

## TENTATIVE DATA SOLENOID FOCUSED, MEDIUM POWER UHF-BAND AMPLIFIER

### ELECTRICAL CHARACTERISTICS

FREQUENCY RANGE	0.5 TO 1.0 KMC
SMALL-SIGNAL GAIN	30 DB (MIN.)
POWER OUTPUT <sup>1</sup>	30 DBM (MIN.)

### OPERATING CHARACTERISTICS

HELIX AND COLLECTOR VOLTAGE <sup>2</sup>	400 TO 500 VOLTS
HELIX CURRENT <sup>3</sup>	1 MA (MAX.)
COLLECTOR CURRENT	50 MA (MAX.)
ANODE VOLTAGE*	<i>0 to 650</i> <del>250 TO 500</del> VOLTS
GRID VOLTAGE	20 TO 60 VOLTS
GRID CURRENT	45 MA (MAX.)
CATHODE CURRENT	90 MA (MAX.)
HEATER VOLTAGE <sup>4</sup>	6.3 OR 7.0 VOLTS
HEATER CURRENT	<i>2.2</i> <del>1.8</del> AMPS
MAGNETIC FIELD	820 GAUSS

### MECHANICAL CHARACTERISTICS

R-F CONNECTORS	<i>UG 89 B/U</i> <del>TYPE N, FEMALE</del>
D-C CONNECTOR <sup>5</sup>	WINCHESTER M12P-LR6
CAPSULE LENGTH	17 1/8 INCHES
CAPSULE DIAMETER	1 5/16 INCHES
NET WEIGHT	1 1/2 POUNDS

1 WITH INPUT OF 1 MW  
 2 ALL VOLTAGES ARE MEASURED WITH RESPECT TO THE CATHODE  
 3 HELIX OVERLOAD PROTECTION OF 2.0 MA IS REQUIRED  
 4 POWER SUPPLY SHOULD HAVE PROVISION FOR EITHER VOLTAGE  
 5 SUPPLIED WITH MATING CONNECTOR  
 \* ANODE CURRENT . . . . . 1.5 MA (MAX.)



**LIVINGSTON LABORATORIES**  
LIMITED  
 RETCAR STREET · LONDON · N·19  
 ARCHWAY · 6251

SALES & SERVICE IN THE UNITED KINGDOM:-

**B. & K. LABORATORIES LTD.**

4 TILNEY ST., PARK LANE, LONDON, W.1., ENGLAND.

TELEPHONE: GROSVENOR 4567





# HUGGINS LABORATORIES, INC.

711 Hamilton Avenue • Menlo Park, California

## TENTATIVE DATA

### MEDIUM POWER-GRID CONTROLLED TRAVELING WAVE TUBE AMPLIFIER

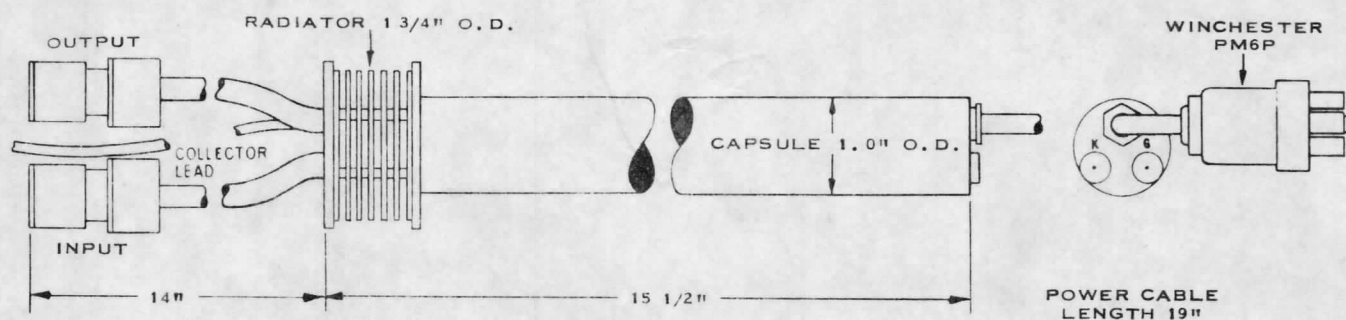

### ELECTRICAL CHARACTERISTICS

FREQUENCY RANGE	-----	8.0 TO 11.0 KMC
POWER OUTPUT	-----	27 DBM (MIN.)
GAIN AT MAXIMUM POWER OUTPUT	-----	27 DB (MIN.)

### POWER SUPPLY REQUIREMENTS

HELIX AND COLLECTOR VOLTAGE <sup>1,2</sup>	-----	2000 TO 2400 VOLTS
CATHODE CURRENT	-----	20 MA. (MAX.)
ANODE VOLTAGE RANGE <sup>2</sup>	-----	1000 TO 1800 VOLTS
ANODE CURRENT	-----	50 $\mu$ A (MAX.)
GRID VOLTAGE <sup>1,2</sup>	-----	0 TO -100 VOLTS
GRID CURRENT	-----	50 $\mu$ A (MAX.)
HEATER VOLTAGE	-----	6.3 VOLTS
HEATER CURRENT	-----	0.9 TO 1.2 AMPS
MAGNETIC FIELD	-----	1000 GAUSS (MIN.)

### MECHANICAL CHARACTERISTICS

RF CONNECTORS	-----	TYPE N MALE
DC CONNECTOR	-----	WINCHESTER PLUG* PM6P
CAPSULE LENGTH	-----	15 1/2 INCHES
CAPSULE DIAMETER	-----	1.0 INCH
NET WEIGHT	-----	2 POUNDS
SHIPPING WEIGHT	-----	12 POUNDS

\* SUPPLIED WITH MATING RECEPTACLE.

<sup>1</sup> COLLECTOR AND HELIX, GRID, OR CATHODE MAY BE OPERATED AT GROUND POTENTIAL.

<sup>2</sup> ALL VOLTAGES ARE MEASURED WITH RESPECT TO CATHODE. ANODE SUPPLY MUST START FROM ZERO VOLTS FOR INITIAL FOCUSING PURPOSES.



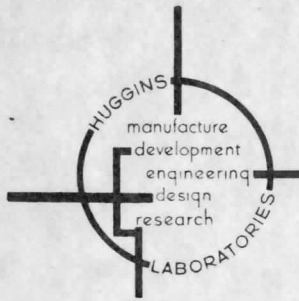

**HUGGINS LABORATORIES, INC.**  
 711 Hamilton Avenue · Menlo Park, California

**TENTATIVE DATA**  
**MEDIUM POWER HIGH GAIN TRAVELING WAVE**  
**TUBE AMPLIFIER**

**ELECTRICAL CHARACTERISTICS**

FREQUENCY RANGE..... 8.2 TO 12.4 KMC  
 POWER OUTPUT..... 20 DBM (MIN.)  
 GAIN AT MAXIMUM POWER OUTPUT..... 20 DB (MIN.)  
 SMALL SIGNAL GAIN..... 25 DB (MIN.)

**POWER SUPPLY REQUIREMENTS<sup>1</sup>**

HELIX AND COLLECTOR VOLTAGE..... 2000 TO 2300 VOLTS  
 CATHODE CURRENT..... 8 MA (MAX.)  
 ANODE VOLTAGE RANGE<sup>2</sup>..... 0 TO 800 VOLTS  
 HELIX CURRENT..... 0.5 MA (MAX.)  
 ANODE CURRENT..... 50 μA (MAX.)  
 HEATER VOLTAGE..... 7.0 VOLTS  
 HEATER CURRENT..... 1.1 AMPS (MAX.)  
 MAGNETIC FIELD..... 1000 GAUSS

**MECHANICAL CHARACTERISTICS**

RF CONNECTOR..... TYPE N MALE  
 DC CONNECTOR..... WINCHESTER PM6P\*  
 CAPSULE LENGTH..... 13 5/8 INCHES  
 CAPSULE DIAMETER..... 1.0 INCH  
 NET WEIGHT..... 1.0 POUND

\* SUPPLIED WITH MATING CONNECTOR.

1. ALL DC VOLTAGES MEASURED WITH RESPECT TO CATHODE. COLLECTOR IS GROUNDED TO CAPSULE AND MUST BE OPERATED AT GROUND POTENTIAL.
2. ANODE VOLTAGE SUPPLY MUST BE ADJUSTABLE FROM ZERO FOR INITIAL FOCUSING PURPOSES.

# PERFORMANCE

## GAIN and POWER OUTPUT

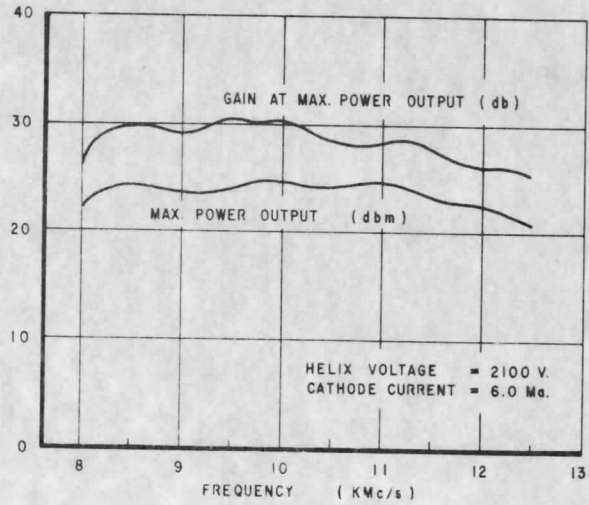

## DIMENSIONS

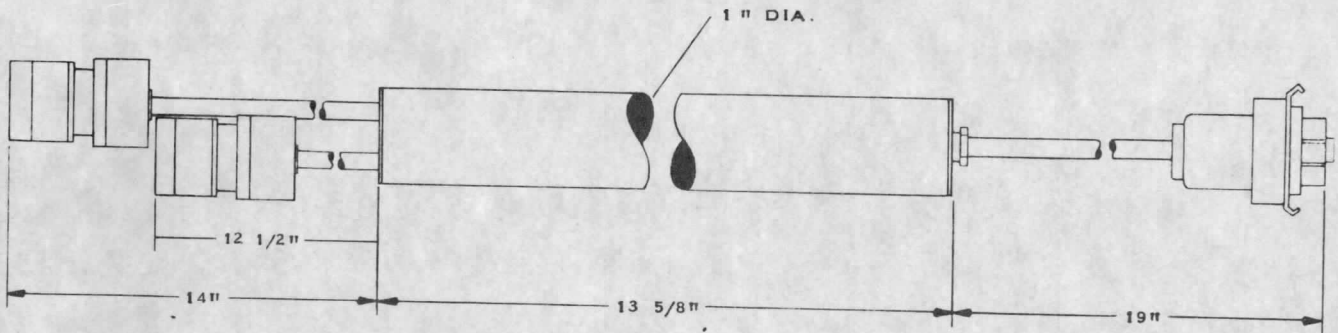

NOTE: OTHER LEAD LENGTHS OR CONNECTORS MAY BE SPECIFIED.

## SOLENOID

SEE SOLENOID CHART FOR APPROPRIATE UNIT AND SPECIFICATIONS.



# HUGGINS LABORATORIES, INC.

999 East Arques Avenue · Sunnyvale, California

## SOLENOID – FOCUSED, MEDIUM – NOISE S – BAND AMPLIFIER

### ELECTRICAL CHARACTERISTICS

FREQUENCY RANGE . . . . .	2.0 TO 4.0 KMC
SMALL-SIGNAL GAIN . . . . .	25 DB MIN
SATURATION POWER OUTPUT. . . . .	0 DBM MIN
NOISE FIGURE . . . . .	15 DB MAX
VSWR, INPUT AND OUTPUT . . . . .	2:1 MAX

### OPERATING CHARACTERISTICS

ELEMENT	VOLTAGE	%REGULATION	CURRENT
HELIX	375 TO 475 V	--	0.03 MA MAX
COLLECTOR	375 TO 475 V	--	2.0 MA MAX
ANODE 1	0 TO 50 V	--	0.01 MA MAX
ANODE 2	0 TO 80 V	--	0.01 MA MAX
ANODE 3	0 TO 150 V	--	0.01 MA MAX
ANODE 4	0 TO -50 V	--	0.01 MA MAX
CATHODE	0 V	--	2.0 MA MAX
HEATER	5.0 TO 7.5 V	--	1.1 AMP MAX

FOCUSING . . . . . SOLENOID, MPE TYPE AS - 10

### MECHANICAL CHARACTERISTICS

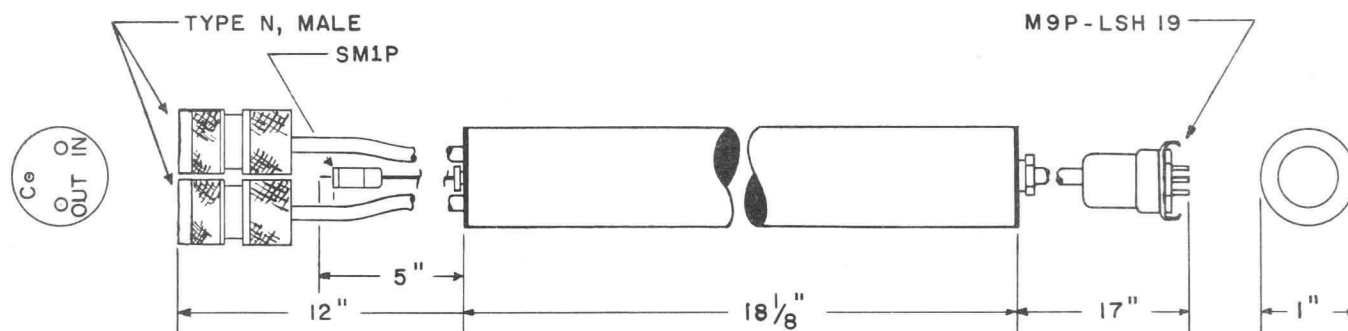

CAPSULE FINISH. . . . .	BLACK ANODIZED
END CAP FINISH. . . . .	BLACK ANODIZED
AUXILIARY COOLING REQUIRED . . . . .	SOLENOID BLOWER
NET WEIGHT . . . . .	1.0 LB

<sup>1</sup> A LOWER NOISE FIGURE CAN BE ACHIEVED BY OPTIMIZING THE TUBE FOR NARROWBAND OPERATION.

## TYPICAL OPERATING CHARACTERISTICS

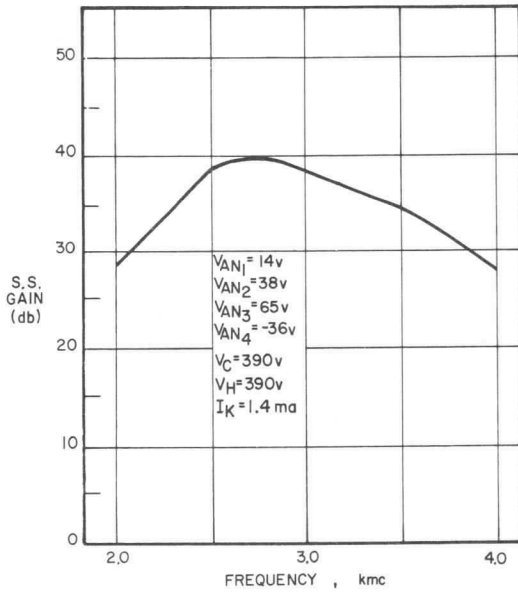

SMALL-SIGNAL GAIN

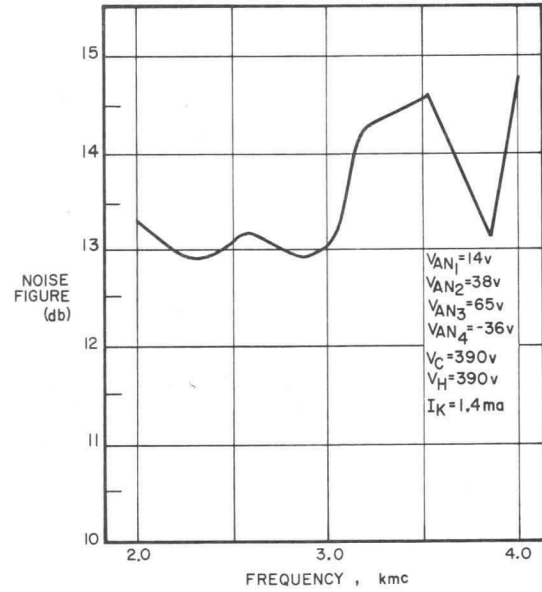

NOISE FIGURE

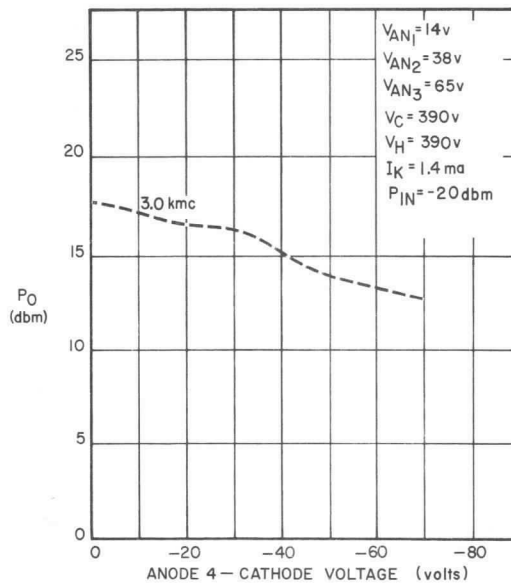

ANODE 4 CONTROL

*Withdrawn from loose leaf  
1958*

HA - 12



**HUGGINS LABORATORIES, INC.**  
711 Hamilton Avenue • Menlo Park, California

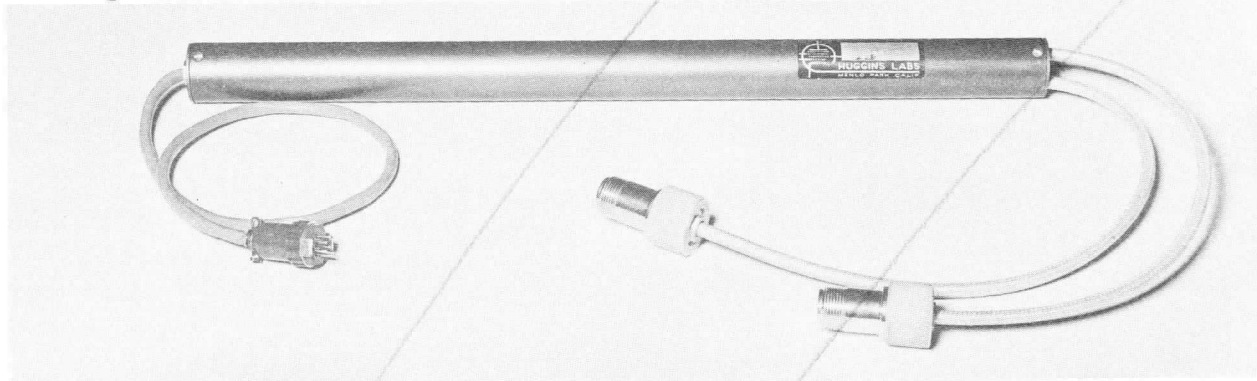

**MEDIUM POWER - GRID CONTROLLED  
TRAVELING-WAVE AMPLIFIER TUBE**

**GENERAL CHARACTERISTICS**

**ELECTRICAL**

FREQUENCY RANGE . . . . .	2.0 - 4.0 KMc/s
SMALL SIGNAL GAIN . . . . .	34 db (Min.)
POWER OUTPUT . . . . .	30 dbm (Min.)
GAIN AT MAXIMUM POWER OUTPUT . . . . .	30 db (Min.)

**OPERATING**

HELIX & COLLECTOR VOLTAGE . . . . .	950 Volts
CATHODE CURRENT . . . . .	35.0 Ma (Max.)
ANODE VOLTAGE . . . . .	400 Volts (Max.)
ANODE CURRENT . . . . .	50 ua (Max.)
GRID VOLTAGE . . . . .	100 Volts (Max.)
GRID CURRENT . . . . .	12.5 Ma (Max.)
HEATER VOLTAGE . . . . .	7.0 Volts
HEATER CURRENT . . . . .	0.8 Amps.
MAGNETIC FIELD . . . . .	600 Gauss

**MECHANICAL**

RF CONNECTORS . . . . .	BNC Male UG-88C/U
DC CONNECTOR . . . . .	Octal or Winchester Plug (M7P)
CAPSULE LENGTH . . . . .	14 3/4 Inches
CAPSULE DIAMETER . . . . .	1.0 Inch
NET WEIGHT . . . . .	1 1/4 Pounds
SHIPPING WEIGHT . . . . .	11 1/4 Pounds



GAIN  
and  
POWER OUTPUT

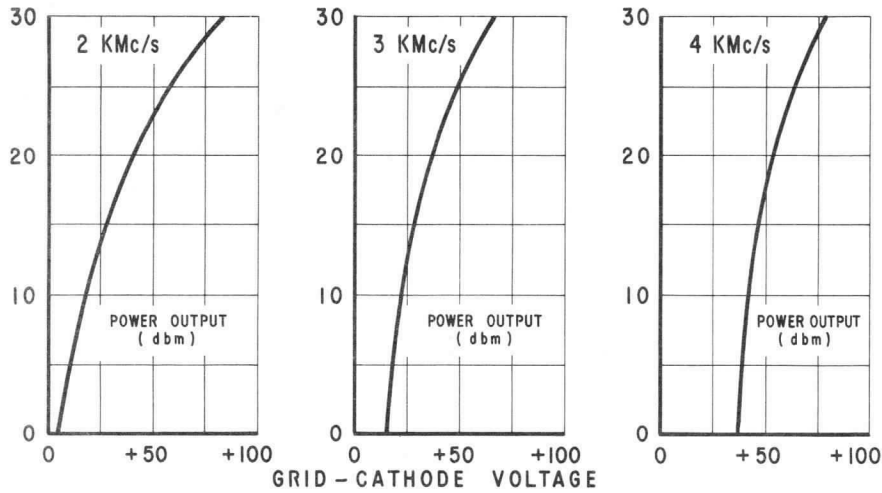
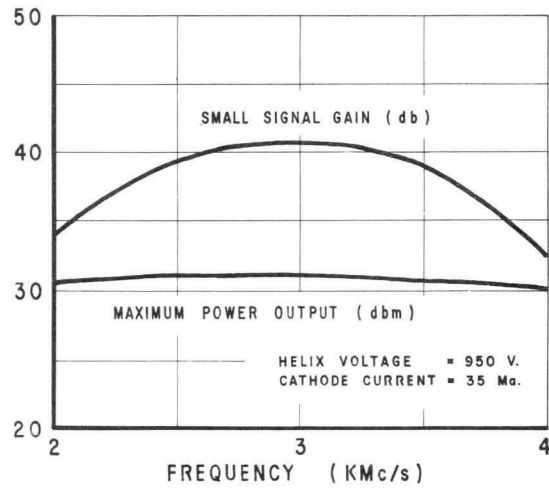

GRID  
CHARACTERISTICS

DIMENSIONS

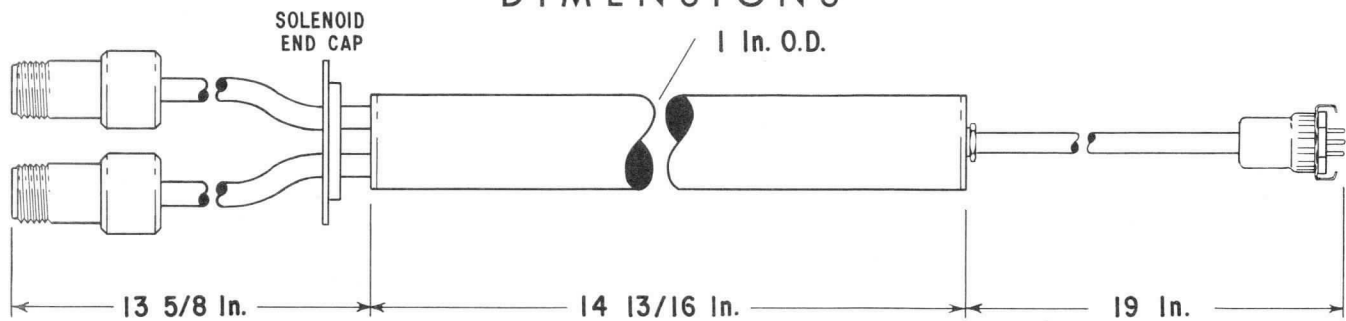

Note: Other lead lengths or connectors may be specified.

SOLENOID

See solenoid charts for appropriate unit and specifications.

Withdrawn from  
box lot 1958

HA - 13



HUGGINS LABORATORIES, INC.

711 Hamilton Avenue • Menlo Park, California

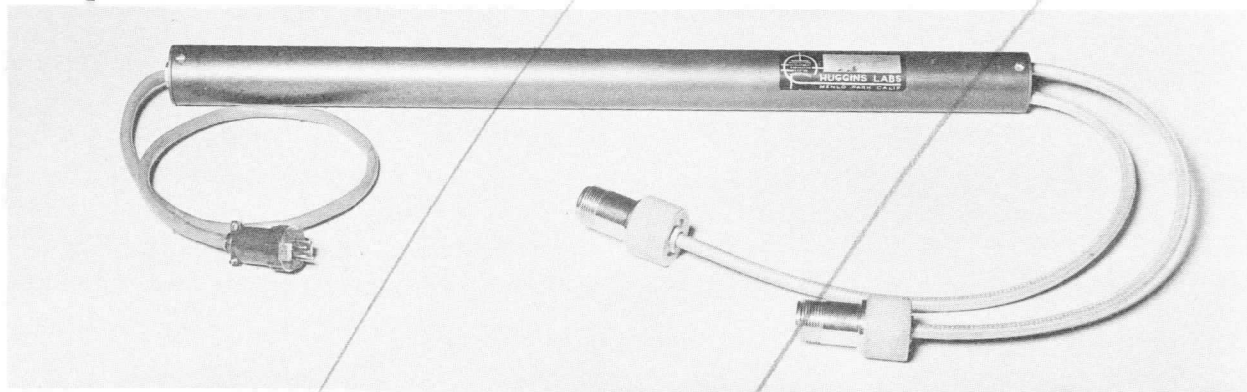

MEDIUM POWER - GRID CONTROLLED  
TRAVELING-WAVE AMPLIFIER TUBE

GENERAL CHARACTERISTICS

ELECTRICAL

FREQUENCY RANGE . . . . .	8.2 - 12.4 KMc/s
POWER OUTPUT (CW) . . . . .	20 dbm (Min.)
POWER OUTPUT (PULSED) . . . . .	30 dbm (Min.)
GAIN AT MAXIMUM POWER OUTPUT . . . . .	20 db (Min.)

OPERATING

HELIX & COLLECTOR VOLTAGE . . . . .	2100 Volts
CATHODE CURRENT (CW) . . . . .	13 Ma. (Max.)
ANODE VOLTAGE RANGE . . . . .	150 - 800 Volts
ANODE CURRENT . . . . .	50 ua. (Max.)
GRID VOLTAGE (CW) . . . . .	75 Volts (Max.)
GRID VOLTAGE (PULSED) . . . . .	100 Volts (Max.)
GRID CURRENT . . . . .	5 Ma. (Max.)
HEATER VOLTAGE . . . . .	7.0 Volts
HEATER CURRENT . . . . .	0.8 Amps.
MAGNETIC FIELD . . . . .	1000 Gauss

MECHANICAL

RF CONNECTORS . . . . .	Type N Female
DC CONNECTOR . . . . .	Winchester Plug PM6P*
CAPSULE LENGTH . . . . .	13.6 Inches
CAPSULE DIAMETER . . . . .	1.0 Inch
NET WEIGHT . . . . .	1 Pound
SHIPPING WEIGHT . . . . .	11 Pounds

\*Supplied with mating receptacle.

PERFORMANCE

PULSED and C W  
POWER OUTPUT

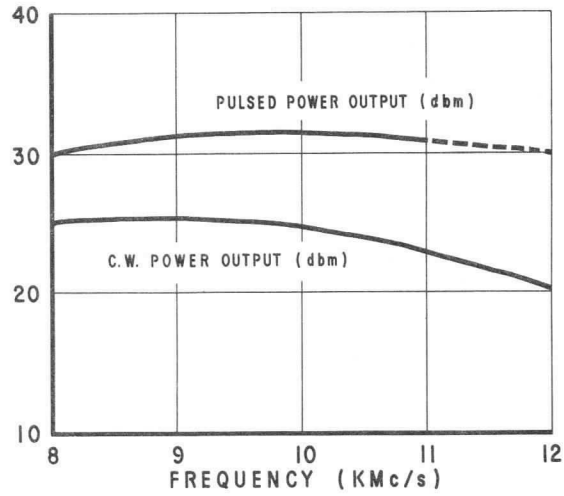

DIMENSIONS

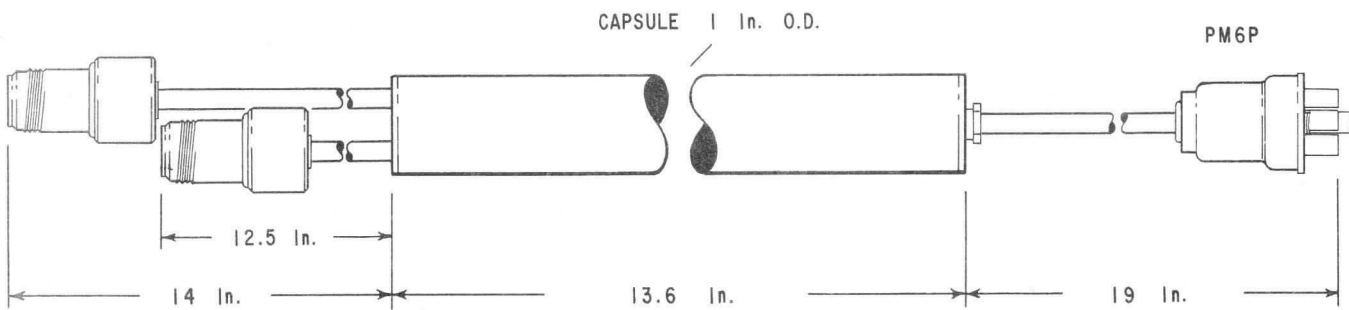

NOTE: Other lead lengths or connectors may be specified.

SOLENOID

See Solenoid Section for appropriate unit and specifications.

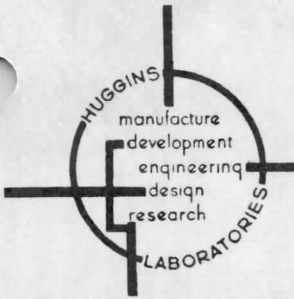

# HUGGINS LABORATORIES, INC.

711 Hamilton Avenue • Menlo Park, California.

## TENTATIVE DATA

### LOW NOISE L-BAND TRAVELING WAVE TUBE AMPLIFIER

#### ELECTRICAL CHARACTERISTICS

FREQUENCY RANGE-----1.0 TO 2.0 KMC  
 SMALL SIGNAL GAIN-----25 DB ( MIN. )  
 NOISE FIGURE-----11 DB ( MAX. )

#### POWER SUPPLY REQUIREMENTS

HELIX AND COLLECTOR VOLTAGE<sup>1</sup>-----165 TO 190 VOLTS  
 CATHODE CURRENT-----0.65 TO 0.80 MA *max*  
 HELIX CURRENT-----< 10  $\mu$ A  
 ANODE NO. 1 VOLTAGE<sup>2</sup>-----0 TO 20 VOLTS  
 ANODE NO. 2 VOLTAGE-----0 TO 20 VOLTS  
 ANODE NO. 3 VOLTAGE-----0 TO 100 VOLTS  
 ANODE NO. 4 VOLTAGE-----+20 TO -10 VOLTS  
 HEATER VOLTAGE-----4.5 TO 6.3 VOLTS  
 HEATER CURRENT-----.45 TO 0.7 AMPS  
 MAGNETIC FIELD-----1000 GAUSS

#### MECHANICAL CHARACTERISTICS

RF CONNECTOR-----TYPE N MALE  
 DC CONNECTOR-----WINCHESTER M9P\*  
 CAPSULE LENGTH-----15 1/2 <sup>5</sup>/<sub>8</sub> INCHES  
 CAPSULE DIAMETER-----1.0 INCH  
 NET WEIGHT-----1.0 POUND

\* SUPPLIED WITH MATING CONNECTOR.

1 ALL DC VOLTAGES MEASURED WITH RESPECT TO CATHODE. COLLECTOR IS INSULATED AND THUS ANY ELECTRODE MAY BE OPERATED AT GROUND POTENTIAL.

2 ALL ANODE VOLTAGES SHOULD BE ADJUSTABLE FROM ZERO FOR INITIAL FOCUSING PURPOSES,

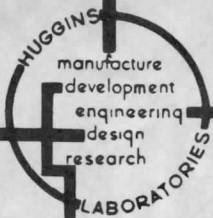

HUGGINS LABORATORIES  
MENLO PARK CALIFORNIA



HA-15

MEDIUM NOISE X-BAND AMPLIFIER

THIS AMPLIFIER IS FURNISHED FOR REPLACEMENT PURPOSES ONLY, AND HAS BEEN SUPERSEDED BY THE HA-44. THE DIFFERENCES BETWEEN THE TWO TUBES ARE:

1. CAPSULE LENGTH

TUBE TYPE	CAPSULE LENGTH, INCHES
HA-15	13 3/4 13.8
HA-44	14 3/4

2. NECESSITY OF CONTINUOUSLY VARIABLE HEATER VOLTAGE AND POSITIVE COLLECTOR OPERATION ( WITH RESPECT TO THE HELIX ) ON THE HA-44. ( SEE HA-44 DATA SHEET, )

3. DIFFERENCES IN REQUIRED SOLENOID TYPE:

TUBE TYPE	MPE SOLENOID TYPE
HA-15	BS-4B, BS-4C
HA-44	BS-13B, BS-13C



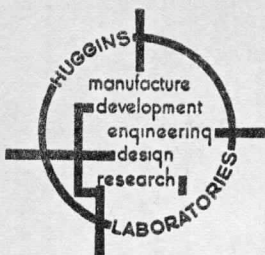

# HUGGINS LABORATORIES, INC.

711 Hamilton Avenue • Menlo Park, California

## TENTATIVE DATA

### SPECIAL PURPOSE TRAVELING WAVE TUBE AMPLIFIER S-BAND TO X-BAND FREQUENCY MULTIPLIER

#### ELECTRICAL CHARACTERISTICS

FREQUENCY RANGE -----1.8 KMC IN, 9.0 KMC OUT  
 CONVERSION GAIN -----MINUS 10 DB - 0 DB  
 X-BAND POWER OUTPUT -----3 - 10 DBM

#### OPERATING CHARACTERISTICS

HELIX AND COLLECTOR VOLTAGE<sup>1</sup> -900 - 1100 VOLT  
 CATHODE CURRENT -----25 MA  
 HELIX CURRENT -----100 UA *300 max*  
 ANODE VOLTAGE -----400 - 550 VOLT *0 to 550*  
 HEATER VOLTAGE -----7.0 VOLT  
 HEATER CURRENT -----0.9 AMP  
 MAGNETIC FIELD -----600 GAUSS

#### MECHANICAL CHARACTERISTICS

RF CONNECTOR -----TYPE N MALE  
 DC CONNECTOR -----WINCHESTER M7P  
 CAPSULE LENGTH -----14 3/4 INCHES *15 5/8*  
 CAPSULE DIAMETER -----1.0 INCH  
 NET WEIGHT -----1.0 POUND

PRICE \$850.00

DELIVERY 6 TO 8 WEEKS

<sup>1</sup>ALL DC VOLTAGES MEASURED WITH RESPECT TO CATHODE. COLLECTOR IS GROUNDED TO CAPSULE AND MUST OPERATE AT GROUND POTENTIAL.

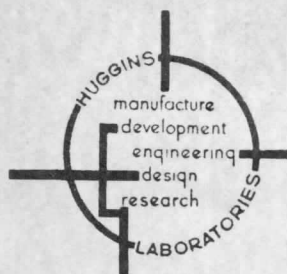

# HUGGINS LABORATORIES, INC.

711 Hamilton Avenue • Menlo Park, California.

## TENTATIVE DATA

### MEDIUM NOISE L-BAND TRAVELING WAVE TUBE AMPLIFIER

#### ELECTRICAL CHARACTERISTICS

FREQUENCY RANGE-----1.0 TO 2.0 KMC  
 SMALL SIGNAL GAIN-----25 DB (MIN.)  
 POWER OUTPUT-----5 DBM (MIN.)  
 NOISE FIGURE-----15 DB (MAX.)

#### POWER SUPPLY REQUIREMENTS

HELIX AND COLLECTOR VOLTAGE<sup>1</sup>-----170 TO 200 VOLTS  
 CATHODE CURRENT-----1.5 MA (MAX.)  
 ANODE NO. 1 VOLTAGE<sup>2</sup>-----0 TO 20 VOLTS  
 ANODE NO. 2 VOLTAGE-----0 TO 20 VOLTS  
 ANODE NO. 3 VOLTAGE-----0 TO 100 VOLTS  
 ANODE NO. 4 VOLTAGE-----0 TO -10 VOLTS  
 ANODE CURRENT-----LESS THAN 5  $\mu$ A  
 HEATER VOLTAGE-----5.0 TO 6.3 VOLTS  
 HEATER CURRENT-----0.5 TO 0.7 AMPS  
 MAGNETIC FIELD-----1000 GAUSS

#### MECHANICAL CHARACTERISTICS

RF CONNECTOR-----TYPE N FEMALE *MALE*  
 DC CONNECTOR-----WINCHESTER M9P\*  
 CAPSULE LENGTH-----15  $\frac{1}{2}$  INCHES *5/8*  
 CAPSULE DIAMETER-----1.0 INCH  
 NET WEIGHT-----1.0 POUND

\* SUPPLIED WITH MATING RECEPTACLE.

1 ALL DC VOLTAGES MEASURED WITH RESPECT TO CATHODE. COLLECTOR IS INSULATED AND THUS ANY ELECTRODE MAY BE OPERATED AT GROUND POTENTIAL.

2 ALL ANODE VOLTAGES SHOULD BE ADJUSTABLE FROM ZERO FOR INITIAL FOCUSING PURPOSES.

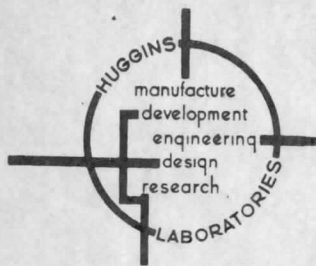

**HUGGINS LABORATORIES, INC.**  
 711 Hamilton Avenue • Menlo Park, California

**TENTATIVE DATA**  
**MEDIUM POWER C-BAND TRAVELING-WAVE TUBE**  
**AMPLIFIER**

**ELECTRICAL CHARACTERISTICS**

FREQUENCY RANGE.....	1.0 TO 2.0 KMC
SMALL SIGNAL GAIN.....	30 DB ( MIN. )
POWER OUTPUT.....	30 DBM (MIN.)
( LOAD VSWR < 2:1	OPTIMIZED HELIX VOLTAGE
	27 DBM (MIN.)
	BROADBAND..1.0 TO 2.0 KMC
GAIN AT MAXIMUM POWER OUTPUT...	27 DB ( MIN. )

**POWER SUPPLY REQUIREMENTS<sup>1</sup>**

HELIX.....	550 TO 700 VOLTS
COLLECTOR VOLTAGE.....	650 TO 800 VOLTS
CATHODE CURRENT.....	30 TO 50 MA
HELIX CURRENT.....	3 MA ( MAX. )
ANODE VOLTAGE <sup>2</sup> .....	500 VOLTS ( MAX. )
ANODE CURRENT.....	1 MA ( MAX. )
HEATER VOLTAGE.....	7.0 VOLTS
HEATER CURRENT.....	1.3 AMPS ( MAX. )
MAGNETIC FIELD.....	820 GAUSS

**MECHANICAL CHARACTERISTICS**

RF CONNECTOR.....	TYPE BNC FEMALE
DC CONNECTOR.....	WINCHESTER M7P*
CAPSULE LENGTH.....	17 1/8 INCHES
CAPSULE DIAMETER.....	1 5/16 INCHES
NET WEIGHT.....	1 1/2 POUNDS
SHIPPING WEIGHT.....	11 POUNDS

\* SUPPLIED WITH MATING CONNECTOR.

1. ALL DC VOLTAGES MEASURED WITH RESPECT TO CATHODE. COLLECTOR IS GROUNDED TO CAPSULE AND MUST BE OPERATED AT GROUND POTENTIAL.
2. ANODE VOLTAGE RANGE FOR RATED BEAM CURRENT IS 100 TO 500 VOLTS. ANODE SUPPLY MUST BE ADJUSTABLE FROM ZERO VOLTS FOR INITIAL FOCUSING PURPOSES.



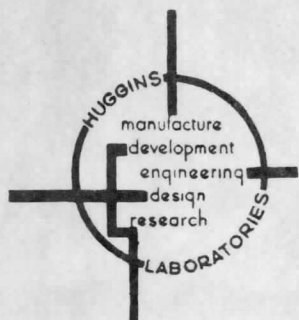

# HUGGINS LABORATORIES, INC.

711 Hamilton Avenue • Menlo Park, California

## TENTATIVE DATA

### MEDIUM NOISE L-BAND TRAVELING WAVE TUBE AMPLIFIER

#### ELECTRICAL CHARACTERISTICS

FREQUENCY RANGE----- 1.6 TO 2.6 KMC  
 SMALL SIGNAL GAIN----- 25 DB (MIN.)  
 POWER OUTPUT----- 5 DBM (MIN.)  
 NOISE FIGURE----- 15 DB (MAX.)

#### POWER SUPPLY REQUIREMENTS

HELIX AND COLLECTOR VOLTAGE<sup>1</sup>----- 170 TO 200 VOLTS  
 CATHODE CURRENT----- 1.5 MA  
 HELIX CURRENT----- 20  $\mu$ A  
 ANODE NO. 1 VOLTAGE<sup>2</sup>----- 0 TO 20 VOLTS  
 ANODE NO. 2 VOLTAGE----- 0 TO 20 VOLTS  
 ANODE NO. 3 VOLTAGE----- 0 TO 100 VOLTS  
 ANODE NO. 4 VOLTAGE----- 0 TO -10 VOLTS  
 HEATER VOLTAGE----- 5.0 TO 6.3 VOLTS  
 HEATER CURRENT----- .5 TO .65 AMPS  
 MAGNETIC FIELD----- 1000 GAUSS

#### MECHANICAL CHARACTERISTICS

RF CONNECTOR----- TYPE N FEMALE *MALE*  
 DC CONNECTOR----- WINCHESTER M9P\*  
 CAPSULE LENGTH----- 15 1/2 INCHES *5/8*  
 CAPSULE DIAMETER----- 1.0 INCH  
 NET WEIGHT----- 1.0 POUND

\* SUPPLIED WITH MATING RECEPTACLE.

1 ALL DC VOLTAGES MEASURED WITH RESPECT TO CATHODE. COLLECTOR IS INSULATED AND THUS ANY ELECTRODE MAY BE OPERATED AT GROUND POTENTIAL.

2 ALL ANODE VOLTAGES SHOULD BE ADJUSTABLE FROM ZERO FOR INITIAL FOCUSING PURPOSES.



# HUGGINS LABORATORIES, INC.

711 Hamilton Avenue • Menlo Park, California

## TENTATIVE DATA

### PERMANENT MAGNET FOCUSED HIGH GAIN TRAVELING WAVE TUBE AMPLIFIER

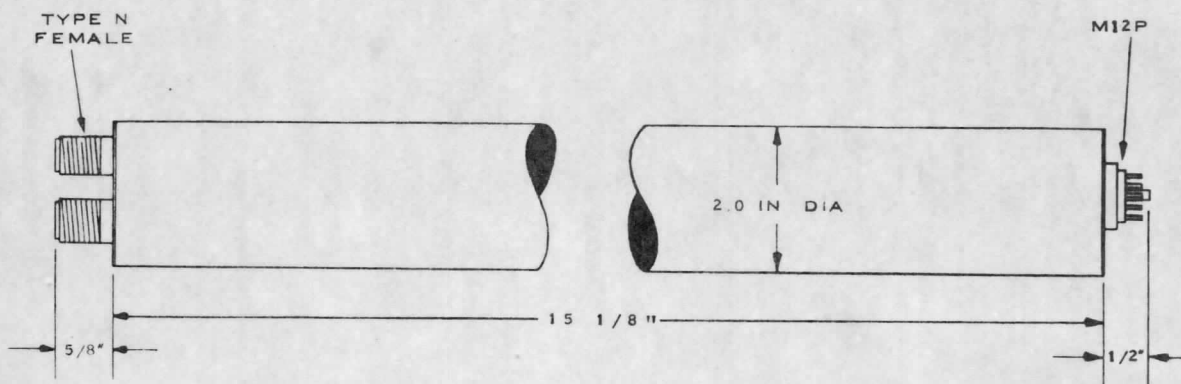

#### ELECTRICAL CHARACTERISTICS

FREQUENCY RANGE-----	8.0 TO 11.0 KMC
SMALL SIGNAL GAIN-----	30 DB (MIN.)
POWER OUTPUT-----	10 DBM (MIN.)

#### POWER SUPPLY REQUIREMENTS

HELIX AND COLLECTOR VOLTAGE <sup>1</sup> -----	1200 TO 1300 VOLTS
CATHODE CURRENT-----	1.2-1.8 MA
HELIX CURRENT-----	0.2-0.5 MA
ANODE VOLTAGE <sup>2</sup> -----	0 TO 450 VOLTS
ANODE CURRENT-----	50 μA (MAX.)
HEATER VOLTAGE-----	6.3 OR 7.0 VOLTS <sup>3</sup>
HEATER CURRENT-----	0.9 TO 1.2 AMPS

#### MECHANICAL CHARACTERISTICS

RF CONNECTOR-----	TYPE N FEMALE ON CAPSULE
DC CONNECTOR-----	WINCHESTER M12P
CAPSULE LENGTH-----	15 1/8 INCHES
CAPSULE DIAMETER-----	2.0 INCHES
NET WEIGHT-----	3.6 POUNDS

1 ALL DC VOLTAGES MEASURED WITH RESPECT TO CATHODE.

2 THE ANODE VOLTAGE SUPPLY MUST COVER THE RANGE 0-450 VOLTS TO PREVENT POSSIBLE TUBE DAMAGE WHEN INITIALLY APPLYING VOLTAGES.

3 PROVISION SHOULD BE MADE TO ALLOW FOR EITHER 6.3 OR 7.0 VOLT OPERATION TO OBTAIN OPTIMUM LIFE PERFORMANCE FROM THE TUBE.