

**RCA TUBE
HANDBOOK
HB-3**



**RECEIVING
TUBE
SECTION — Part 2**

This Section contains data for those tubes used primarily in broadcast and home-television receivers.

*For further Technical Information, write to
Commercial Engineering, Tube Division,
Radio Corporation of America, Harrison, N. J.*

Receiving Tubes—Part 2

Beam Power Tube— Sharp-Cutoff Pentode

DUODECAR TYPE

GENERAL DATA

Electrical:

Heater Characteristics and Ratings:

Voltage (AC or DC)	6.3 ± 0.6	volts
Current at heater volts = 6.3	1.200	amp
Peak heater-cathode voltage (Each unit):		
Heater negative with respect to cathode	200 max.	volts
Heater positive with respect to cathode	200 ^a max.	volts

Direct Interelectrode Capacitances (Approx.):^b

Beam Power Unit:

Grid No.1 to plate	0.26	pf
Grid No.1 to cathode & grid No.3, grid No.2, internal shield, and heater	12.0	pf
Plate to cathode & grid No.3, grid No.2, internal shield, and heater	12.0	pf

Pentode Unit:

Grid No.1 to plate	0.034	pf
Grid No.3 to plate	2.8	pf
Grid No.1 to cathode, grid No.2, grid No.3, internal shield, and heater	6.5	pf
Grid No.3 to cathode, grid No.1, grid No.2, plate, internal shield, and heater	7.5	pf
Grid No.1 to grid No.3	0.24	pf
Plate of beam power unit to plate of pentode unit	0.12	pf

Characteristics, Class A₁ Amplifier (Pentode Unit):

Plate Supply Voltage	150	volts
Grid-No.3 Supply Voltage	Connected to cathode at socket	
Grid-No.2 Supply Voltage	100	volts
Cathode Resistor	560	ohms
Plate Resistance (Approx.)	0.15	megohm
Transconductance, Grid No.1 to Plate	1000	μmhos
Transconductance, Grid No.3 to Plate	400	μmhos
Plate Current	1.3	ma
Grid-No.2 Current	2	ma
Grid-No.1 Voltage (Approx.) for plate $\mu a = 10$	-4.5	volts
Grid-No.3 Voltage (Approx.) for plate $\mu a = 10$	-4.5	volts



6G11

Mechanical:

Operating Position.	Any
Type of Cathodes.	Coated Unipotential
Maximum Overall Length.	2.375"
Seated Length	1.750" to 2.000"
Diameter.	1.062" to 1.188"
Bulb.	T9
Base.	Small-Button Duodecar 12-Pin (JEDEC No. E12-70)
Basing Designation for BOTTOM VIEW.	12BU

Pin 1-Heater	Pin 8-Beam Power Grid No.1
Pin 2-Pentode Cathode	Pin 9-Beam Power Cathode, Beam Power Plate
Pin 3-Pentode Grid No.1	Pin 10-Beam Power Grid No.2
Pin 4-Pentode Grid No.3	Pin 11-Beam Power Plate
Pin 5-Internal Shield	Pin 12-Heater
Pin 6-Pentode Plate	
Pin 7-Pentode Grid No.2	

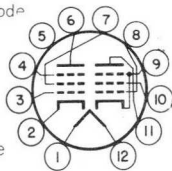

PENTODE UNIT — FM SOUND DETECTOR

Maximum Ratings, Design-Maximum Values:

PLATE VOLTAGE	330 max.	volts
GRID-No.3 (SUPPRESSOR-GRID) VOLTAGE	28 max.	volts
GRID-No.2 (SCREEN-GRID) SUPPLY VOLTAGE.	330 max.	volts
GRID-No.2 VOLTAGE See Grid-No.2 Input Rating Chart at front of Receiving Tube Section	
GRID-No.1 (CONTROL-GRID) VOLTAGE:		
Positive-bias value	0 max.	volts
PLATE DISSIPATION	1.7 max.	watts
GRID-No.2 INPUT:		
For grid-No.2 voltages up to 165 volts	1.1 max.	watts
For grid-No.2 voltages between 165 and 330 volts See Grid-No.2 Input Rating Chart at front of Receiving Tube Section	

BEAM POWER UNIT — AMPLIFIER — Class A₁

Maximum Ratings, Design-Maximum Values:

PLATE VOLTAGE.	150 max.	volts
GRID-No.2 (SCREEN-GRID) VOLTAGE.	135 max.	volts
AVERAGE CATHODE CURRENT.	65 max.	ma
PLATE DISSIPATION.	6.5 max.	watts
GRID-No.2 INPUT.	1.8 max.	watts

Typical Operation and Characteristics:

Plate Voltage.	120	volts
Grid-No.2 Voltage.	110	volts
Grid-No.1 (Control-Grid) Voltage	-8	volts
Peak AF Grid-No.1 Voltage	8	volts



Zero-Signal Plate Current.	49	ma
Max.-Signal Plate Current.	50	ma
Zero-Signal Grid-No.2 Current.	4	ma
Max.-Signal Grid-No.2 Current.	8.5	ma
Plate Resistance (Approx.)	10000	ohms
Transconductance	7500	μ hos
Load Resistance.	2500	ohms
Total Harmonic Distortion.	10	per cent
Max.-Signal Power Output	2.3	watts

a The dc component must not exceed 100 volts.

b without external shield.

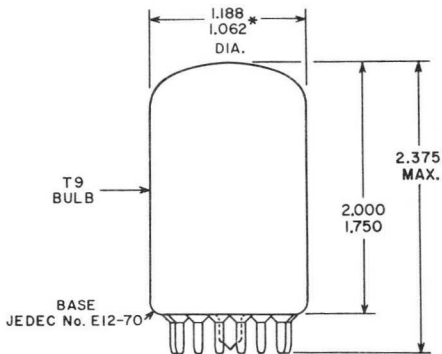

DIMENSIONS IN INCHES

* APPLIES TO MINIMUM DIAMETER EXCEPT IN AREA OF SEAL.





Beam Power Tube

MAGNOVAL TYPE

ELECTRICAL

Heater Characteristics and Ratings

Voltage (AC or DC)	6.3 ± 0.6	V
Current at 6.3 V	1.380	A
Maximum heater-cathode voltage		
Heater negative with respect to cathode:		
Peak	250	V
DC component	125	V
Heater positive with respect to cathode:		
Peak	250	V
DC component	125	V

MECHANICAL

Operating Position	Any
Type of Cathode	Coated Unipotential
Maximum Overall Length	4.125 in
Maximum Seated Length	3.750 in
Diameter	1.062 to 1.188 in
Envelope	JEDEC T9
Cap.	Skirted Miniature (JEDEC No. C1-2)
Base	Small-Button Magnoval 9-Pin (JEDEC No. E9-23) ←

TERMINAL DIAGRAM (Bottom View)

- Pin 1 - Grid-No.1
- Pin 2 - Grid-No.1
- Pin 3 - Cathode,
 Grid No.3
- Pin 4 - Heater
- Pin 5 - Heater
- Pin 6 - Grid No.2
- Pin 7 - Grid No.2
- Pin 8 - Cathode,
 Grid No.3
- Pin 9 - Do Not Use
- Cap - Plate

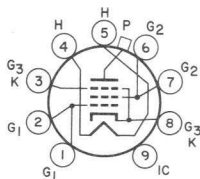

9NH

CHARACTERISTICS, INSTANTANEOUS VALUES^a

Plate Voltage	75	V
Grid-No.2 (Screen-Grid) Voltage	200	V
Grid-No.1 (Control-Grid) Voltage	-10	V
Plate Current	440	mA
Grid-No.2 Current	37	mA

HORIZONTAL-DEFLECTION AMPLIFIER

Maximum Ratings, Design-Maximum Values

For operation in a 525-line, 30-frame system

DC Plate-Supply Voltage	275	V
Peak Positive-Pulse Plate Voltage ^b	7700	V
DC Grid-No.2 Voltage	275	V

← Indicates a change.



6GB5

Average Cathode Current	275	mA
Grid-No.2 Input ^c	5	W
Plate Dissipation ^d	17	W

MAXIMUM CIRCUIT VALUES

Grid-No.1-Circuit Resistance

Without grid current	0.5	MΩ
With grid current (Horizontal output service only).	2.2	MΩ

^a Not to be tested under DC conditions.

^b This rating is applicable where the duration of the voltage pulse does not exceed 15 per cent of one horizontal scanning cycle. In a 525-line, 30-frame system, 15 per cent of one horizontal scanning cycle is 10 microseconds.

^c Grid-No.2 input may reach 6 watts for plate-dissipation values below 11 watts.

^d An adequate bias resistor or other means is required to protect the tube in the absence of excitation.

DIMENSIONAL OUTLINE

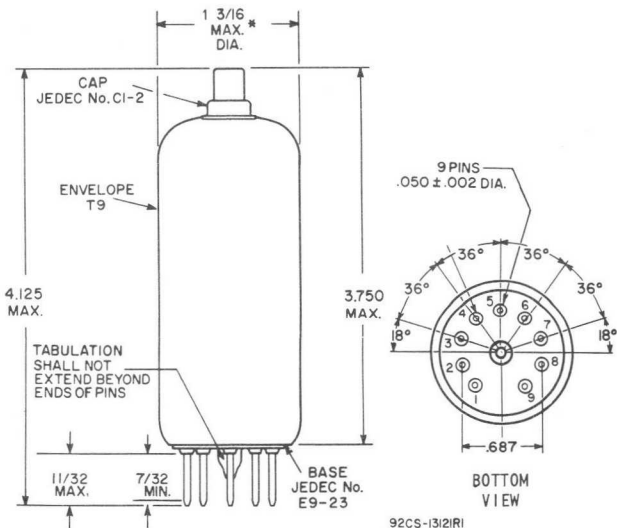

DIMENSIONS IN INCHES

For pin alignment use gauge No. GE9-2.

* Applies in zone starting 0.375 inch from base seat.



Power Pentode

NEONOVAL TYPE

GENERAL DATA

Electrical:

Heater Characteristics and Ratings (*Design-Maximum Values*):

Voltage (AC or DC)	6.3 ± 0.6	volts
Current at heater volts = 6.3	1.200	amp
Peak heater-cathode voltage:		
Heater negative with respect to cathode.	200 max.	volts
Heater positive with respect to cathode.	200 ^a max.	volts
Direct Interelectrode Capacitances (Approx.): ^b		
Grid No.1 to plate.	0.9	μf
Grid No.1 to cathode & grid No.3, grid No.2, and heater	18.0	μf
Plate to cathode & grid No.3, grid No.2 and heater.	7.0	μf

Mechanical:

Operating Position.	Any
Type of Cathode	Coated Unipotential
Maximum Overall Length.	3.230"
Maximum Seated Length	2.920"
Length, Base Seat to Bulb Top (Excluding tip).	2.370" to 2.610"
Diameter.	1.062" to 1.188"
Bulb.	T9
Base.	Large-Button Neonoval 9-Pin (JEDEC No.E9-68)
Basing Designation for BOTTOM VIEW.	9EU

Pin 1-Grid No.2
 Pin 2-No Internal Connection
 Pin 3-Grid No.1
 Pin 4-Heater
 Pin 5-Heater

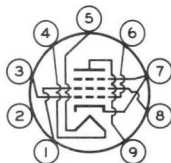

Pin 6-Grid No.1
 Pin 7-Cathode, Grid No.3
 Pin 8-Grid No.2
 Pin 9-Plate

AF POWER AMPLIFIER — Class A₁

Maximum Ratings, *Design-Maximum Values*:

PLATE VOLTAGE	220 max.	volts
GRID-No.2 (SCREEN-GRID) VOLTAGE	140 max.	volts
GRID-No.2 INPUT	1.4 max.	watts
PLATE DISSIPATION	12 max.	watts



6GC5

Typical Operation and Characteristics:

	<i>Fixed Bias</i>	<i>Cathode Bias</i>	
Plate Supply Voltage.	110	200	volts
Grid-No.2 Supply Voltage.	110	125	volts
Grid-No.1 (Control-Grid) Voltage. .	-7.5	-	volts
Cathode Resistor.	-	180	ohms
Peak AF Grid-No.1 Voltage	7.5	8.5	volts
Zero-Signal Plate Current	49	46	ma
Max.-Signal Plate Current	50	47	ma
Zero-Signal Grid-No.2 Current . . .	4	2.2	ma
Max.-Signal Grid-No.2 Current . . .	10	8.5	ma
Plate Resistance (Approx.).	13000	28000	ohms
Transconductance.	8000	8000	μ mhos
Load Resistance	2000	4000	ohms
Total Harmonic Distortion	10	10	%
Max.-Signal Power Output.	2.1	3.8	watts

Maximum Circuit Values:

Grid-No.1-Circuit Resistance:

For fixed-bias operation.	0.1 max.	megohm
For cathode-bias operation.	0.5 max.	megohm

- ^a The dc component must not exceed 100 volts.
^b Without external shield.



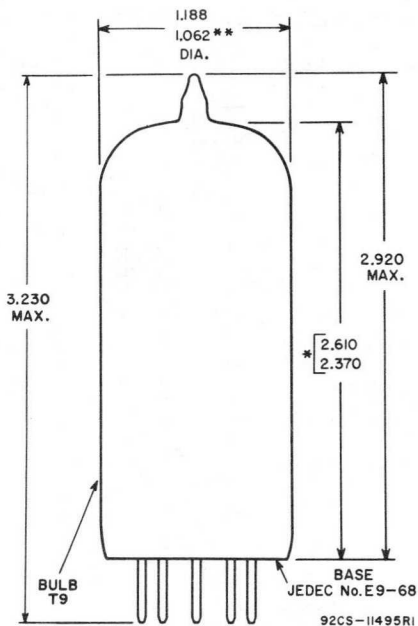

ALL DIMENSIONS IN INCHES

** APPLIES IN ZONE STARTING 0.375" FROM BASE SEAT.

* MEASURED FROM BASE SEAT TO BULB-TOP LINE AS DETERMINED BY A RING GAUGE OF 0.600" INSIDE DIAMETER.



6GC5

AVERAGE PLATE CHARACTERISTICS

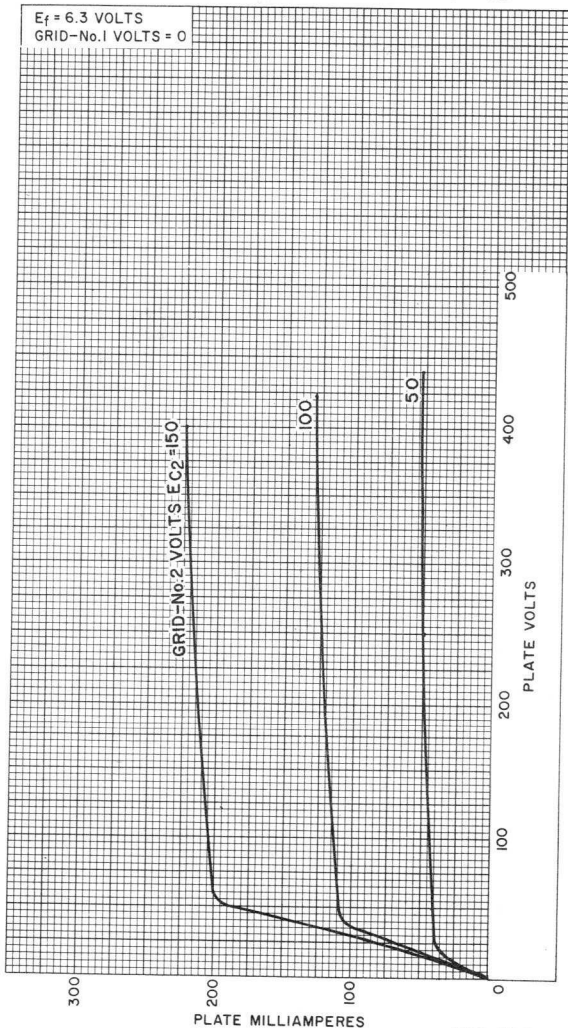

92CM-11824



AVERAGE CHARACTERISTICS

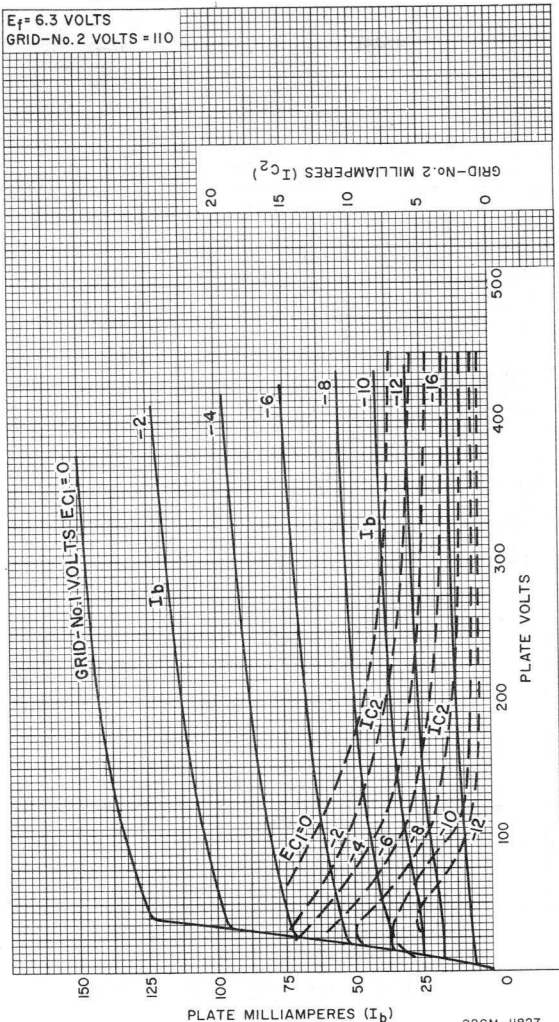

92CM-11827



6GC5

OPERATION CHARACTERISTICS

$E_f = 6.3$ VOLTS
 PLATE VOLTS = 110
 GRID-NO.2 VOLTS = 110
 GRID-NO.1 VOLTS = -7.5
 SIGNAL VOLTS (RMS) = 5.3

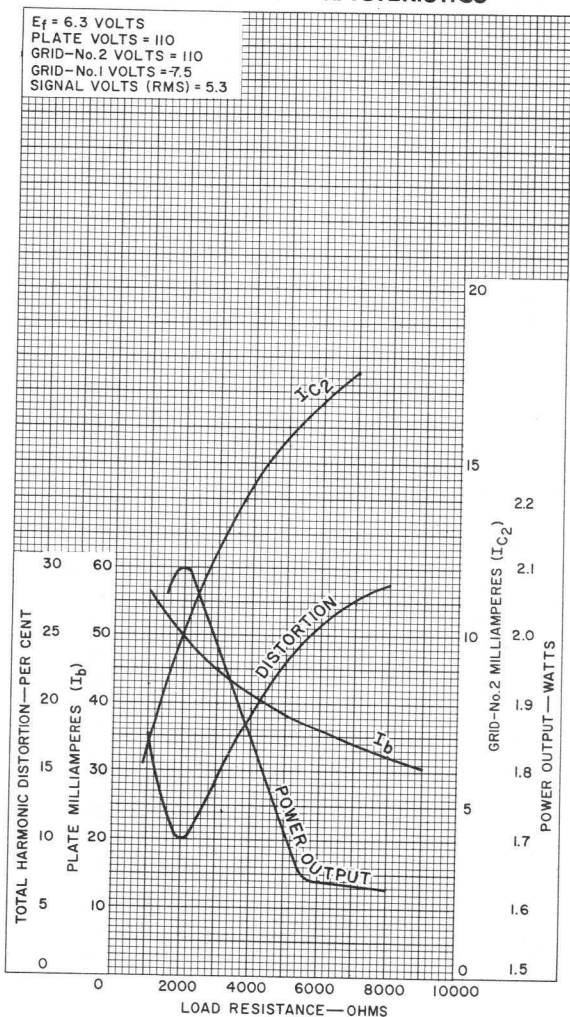

92CM-11828

RADIO CORPORATION OF AMERICA
 Electron Tube Division

Harrison, N. J.



Beam Power Tube

DUODECAR TYPE

GENERAL DATA

Electrical:

Heater Characteristics and Ratings:

Voltage (AC or DC)	6.3 ± 0.6	volts
Current at heater volts = 6.3	1.200	amp

Peak heater-cathode voltage:

Heater negative with respect to cathode	200	max.	volts
Heater positive with respect to cathode	200 ^a	max.	volts

Direct Interelectrode Capacitances (Approx.):^b

Grid No. 1 to plate	0.34	pf
Grid No.1 to cathode & grid No.3, grid No.2, and heater	16.0	pf
Plate to cathode & grid No.3, grid No.2, and heater	7.0	pf

Characteristics, Class A₁ Amplifier:

Plate Voltage	60	150	250	5000	volts
Grid-No.2 Voltage	150	150	150	150	volts
Grid-No.1 Voltage	0	-22.5	-22.5	-	volts
Mu-Factor, Grid No.2 to Grid No.1	-	4.4	-	-	
Plate Resistance (Approx.).	-	-	18000	-	ohms
Transconductance.	-	-	7300	-	μmhos
Plate Current	345 ^c	-	65	-	ma
Grid-No.2 Current	27 ^c	-	1.8	-	ma
Grid-No.1 Voltage (Approx.) for plate ma. = 1	-	-	-42	-100	volts

Mechanical:

Operating Position	Any
Type of Cathode	Coated Unipotential
Maximum Overall Length	2.875"
Seated Length	2.250" to 2.500"
Diameter	1.437" to 1.563"
Bulb	T12
Base	Large-Button Duodecar 12-Pin (JEDEC No.E12-74)
Basing Designation for BOTTOM VIEW	12BJ

- Pin 1-Heater
- Pin 2-Grid No.2
- Pin 3-Grid No.1
- Pin 4-Cathode, Grid No.3
- Pin 5-Do Not Use^d
- Pin 6-Do Not Use^d

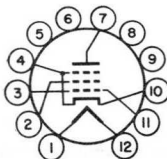

- Pin 7-Plate
- Pin 8-Do Not Use^d
- Pin 9-Do Not Use^d
- Pin 10-Cathode, Grid No.3
- Pin 11-Grid No.1
- Pin 12-Heater



6GE5

HORIZONTAL-DEFLECTION AMPLIFIER

Maximum Ratings, Design-Maximum Values:

For operation in a 525-line, 30-frame system^e

DC PLATE-SUPPLY VOLTAGE	770 max.	volts
PEAK POSITIVE-PULSE PLATE VOLTAGE ^f	6500 max.	volts
PEAK NEGATIVE-PULSE PLATE VOLTAGE	1500 max.	volts
DC GRID-No.2 (SCREEN-GRID) VOLTAGE.	220 max.	volts
DC GRID-No.1 (CONTROL-GRID) VOLTAGE	-55 max.	volts
PEAK NEGATIVE-PULSE GRID-No.1 VOLTAGE	330 max.	volts
CATHODE CURRENT:		
Peak.	550 max.	ma
Average	175 max.	ma
GRID-No.2 INPUT	3.5 max.	watts
PLATE DISSIPATION ^g	17.5 max.	watts
BULB TEMPERATURE (At hottest point on bulb surface).	220 max.	°C

Maximum Circuit Values:

Grid-No.1-Circuit Resistance:

For grid resistor-bias operation. 1 max. megohm

a The dc component must not exceed 100 volts.

b Without external shield.

c This value can be measured by a method involving a recurrent wave form such that the maximum ratings of the tube will not be exceeded.

d Socket terminals 5,6,8, and 9 should not be used as tie points.

e As described in "Standards of Good Engineering Practice Concerning Television Broadcast Stations," Federal Communications Commission.

f This rating is applicable where the duration of the voltage pulse does not exceed 15 per cent of one horizontal scanning cycle. In a 525-line, 30-frame system; 15 per cent of one horizontal scanning cycle is 10 microseconds.

g An adequate bias resistor or other means is required to protect the tube in the absence of excitation.

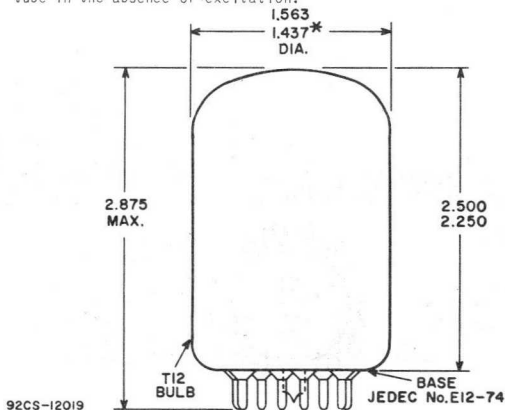

ALL DIMENSIONS IN INCHES
* APPLIES TO MINIMUM DIAMETER EXCEPT IN THE AREA OF THE SEAL.

RADIO CORPORATION OF AMERICA
Electron Tube Division

Harrison, N. J.



Dual Triode

With High-Mu Unit and Low-Mu Unit

NOVAR TYPE

For Combined Vertical-Deflection-Oscillator
and-Amplifier Service in TV Receivers

Electrical:

Heater Characteristics and Ratings:

Voltage (AC or DC)	6.3 ± 0.6	volts
Current at heater volts = 6.3	0.985	amp
Peak heater-cathode voltage (Each unit):		
Heater negative with respect to cathode	200 max.	volts
Heater positive with respect to cathode	200 ^a max.	volts

Direct Inter-electrode Capacitances (Approx.):

	Unit No. 1	Unit No. 2	
Grid to plate	4.6	9.0	pf
G to (K,H)	2.4	6.5	pf
P to (K,H)	0.26	1.4	pf

Mechanical:

Operating Position	Any
Types of Cathodes	Coated Unipotential
Maximum Overall Length	2.380"
Seated Length	1.750" to 2.000"
Diameter	1.062" to 1.188"
Dimensional Outline	See <i>General Section</i>
Bulb	T9
Base	Small-Button Novar, 9-Pin with Exhaust Tip (JEDEC No. E9-89)

Basing Designation for BOTTOM VIEW 9QD

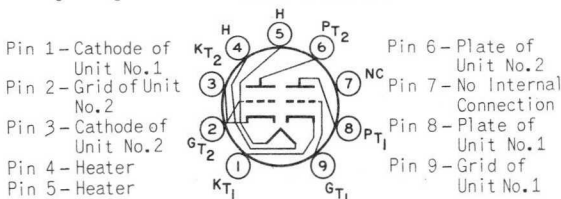

Characteristics, Class A₁ Amplifier:

	Unit No. 1	Unit No. 2	
Plate Voltage	250	60 150 250	volts
Grid Voltage	-3	0 -20 -28	volts
Amplification Factor	64	- 5.4 -	
Plate Resistance (Approx.)	40000	- 750 -	ohms
Plate Current	1.4	95 50 10	ma
Grid-Voltage (Approx.) for			
plate $\mu = 10$	-5.5	- - -	volts
100	-	- -45 -	volts



6GF7A

VERTICAL-DEFLECTION OSCILLATOR

Values are for Unit No. 1

Maximum Ratings, Design-Maximum Values:

For operation in a 525-line, 30-frame system^b

DC Plate Voltage	330 max.	volts
Peak Negative Pulse-Grid Voltage	400 max.	volts
Cathode Current:		
Peak	77 max.	ma
Average.	22 max.	ma
Plate Dissipation.	1.5 max.	watts

Maximum Circuit Values:

Grid-Circuit Resistance:

For grid-resistor-bias or cathode-bias operation	2.2 max.	megohms
---	----------	---------

VERTICAL-DEFLECTION AMPLIFIER

Values are for Unit No. 2

Maximum Ratings, Design-Maximum Values Except as Noted:

For operation in a 525-line, 30-frame system^b

DC Plate Voltage	330 max.	volts
Peak Positive-Pulse Plate Voltage (Absolute-maximum value) ^c	1500 ^d max.	volts
Peak Negative-Pulse Grid Voltage	250 max.	volts
Cathode Current:		
Peak	175 max.	ma
Average.	50 max.	ma
Plate Dissipation.	11 max.	watts

Maximum Circuit Values:

Grid-Circuit Resistance:

For grid-resistor-bias operation	2.2 max.	megohms
For cathode-bias operation	2.2 max.	megohms

^a The dc component must not exceed 100 volts.

^b As described in "Standards of Good Engineering Practice Concerning Television Broadcast Stations" Federal Communications Commission.

^c This rating is applicable where the duration of the voltage pulse does not exceed 15 per cent of one vertical scanning cycle. In a 525-line, 30-frame system, 15 per cent of one vertical scanning cycle is 2.5 milliseconds.

^d Under no circumstances should this absolute-maximum value be exceeded.



AVERAGE PLATE CHARACTERISTICS Unit No.1

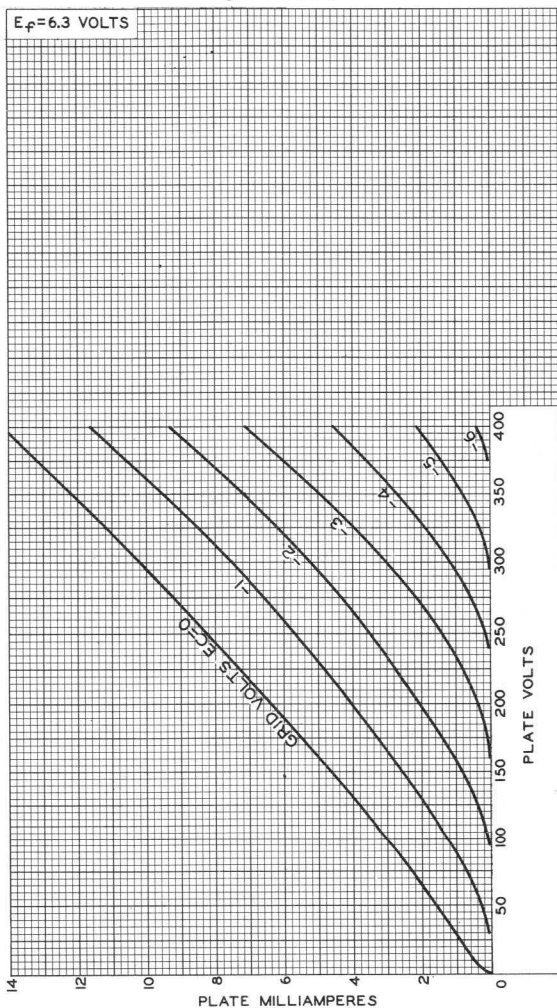

92CM-9912



6GF7A

AVERAGE PLATE CHARACTERISTICS Unit No.2

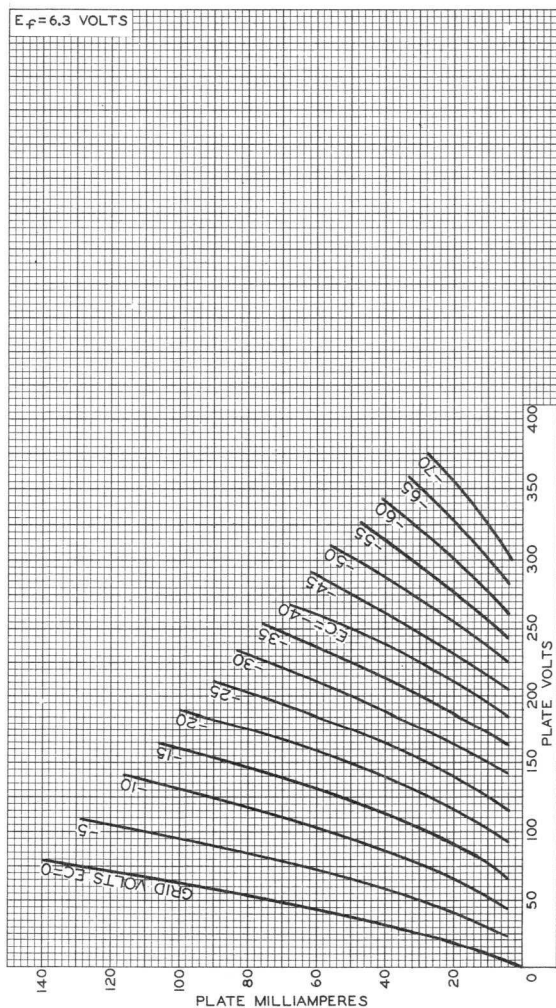

92CM-10466



AVERAGE CHARACTERISTICS Unit No.1

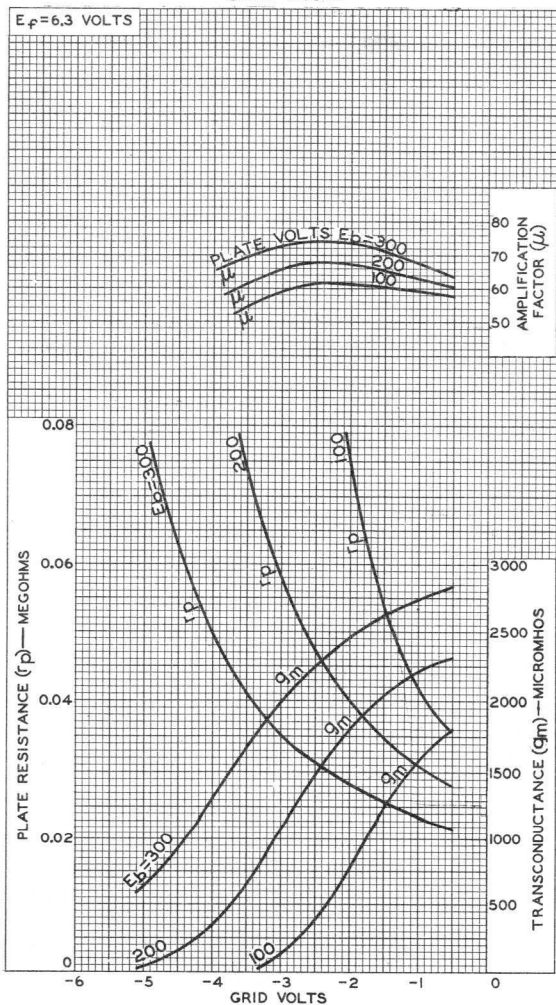

92CM-9915R1



6GF7A

AVERAGE CHARACTERISTICS Unit No.2

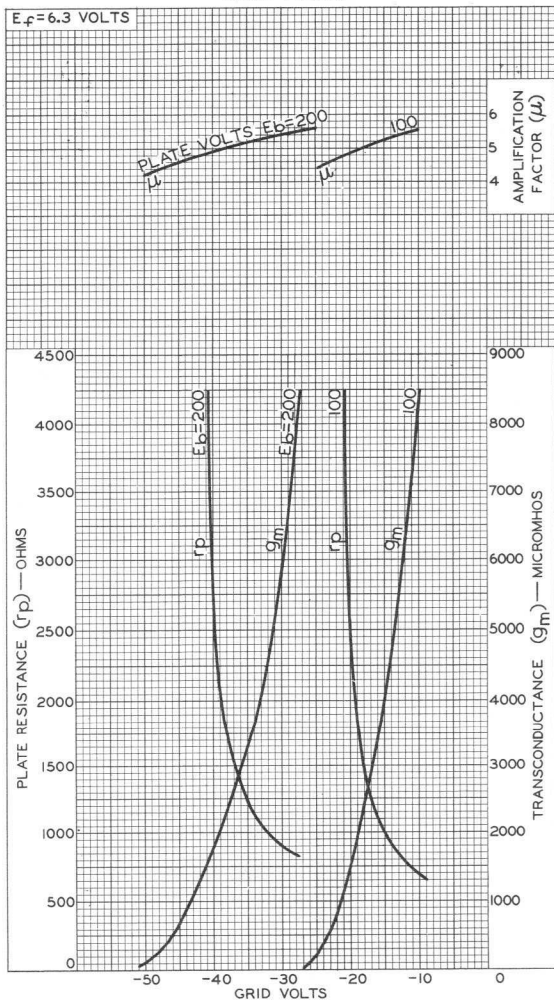

92CM-10467



Medium-Mu Triode— Sharp-Cutoff Pentode

9-PIN MINIATURE TYPE

For Multivibrator-Type Horizontal-Deflection Oscillator, AGC Amplifier, and Sync-Separator Applications

GENERAL DATA

Electrical:

Heater Characteristics and Ratings:

Voltage (AC or DC)	6.3 ^a	6.3 ± 0.6	volts
Current	0.450 ± 0.030	0.450 ^b	amp
Warm-up time (Average)	11	—	sec

Peak heater-cathode voltage (Each unit):

Heater negative with respect to cathode	200 max.	volts
Heater positive with respect to cathode	200 ^c max.	volts

Direct Interelectrode Capacitances:

	Without External Shield	With External Shield ^d	
<i>Triode Unit:</i>			
Grid to plate	1.7	1.7	pf
Grid to cathode, pentode grid No.3 & pentode cathode & internal shield, and heater.	3.0	3.2	pf
Plate to cathode, pentode grid No.3 & pentode cathode & internal shield, and heater.	1.4	1.9	pf
Heater to cathode	3.0	3.0 ^e	pf
<i>Pentode Unit:</i>			
Grid No.1 to plate	0.02 max.	0.01 max.	pf
Grid No.1 to cathode & grid No.3 & internal shield, grid No.2, and heater	5.0	5.0	pf
Plate to cathode & grid No.3 & internal shield, grid No.2, and heater.	2.6	3.4	pf
Heater to cathode & grid No.3 & internal shield	3.0	3.0 ^e	pf

Characteristics, Class A₁ Amplifier:

	Triode Unit	Pentode Unit	
Plate Voltage	125	125	volts
Grid-No.2 Voltage	—	125	volts
Grid-No.1 Voltage	-1	-1	volt
Amplification Factor	46	—	
Plate Resistance (Approx.)	5400	20000	ohms
Transconductance	8500	7500	μmhos



6GH8A

Plate Current	13.5	12	ma
Grid-No.2 Current	-	4	ma
Grid-No.1 Voltage (Approx.) for plate $\mu a = 10$	-8	-8	volts

Mechanical:

Operating Position	Any
Type of Cathodes	Coated Unipotential
Maximum Overall Length	2-3/16"
Maximum Seated Length	1-15/16"
Length, Base Seat to Bulb Top (Excluding tip)	1-9/16" \pm 3/32"
Diameter	0.750" to 0.875"
Dimensional Outline	See <i>General Section</i>
Bulb	T6-1/2
Base	Small-Button Noval 9-Pin (JEDEC No. E9-1)
Basing Designation for BOTTOM VIEW	9AE

- Pin 1 - Triode Plate
- Pin 2 - Pentode
Grid No.1
- Pin 3 - Pentode
Grid No.2
- Pin 4 - Heater
- Pin 5 - Heater
- Pin 6 - Pentode Plate

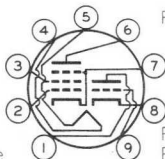

- Pin 7 - Pentode
Cathode,
Pentode
Grid No.3,
Internal
Shield
- Pin 8 - Triode Cathode
- Pin 9 - Triode Grid

HORIZONTAL-DEFLECTION OSCILLATOR

For operation in a 525-line, 30-frame system^f

Maximum Ratings, Design-Maximum Values:

	Triode Unit	Pentode Unit	
PLATE VOLTAGE	330 max.	350 max.	volts
GRID-No.2 (SCREEN-GRID) VOLTAGE	-	330 max.	volts
GRID-No.1 (CONTROL-GRID) VOLTAGE:			
Positive-bias value	0 max.	0 max.	volts
Peak-negative value	-	175 max.	volts
PLATE DISSIPATION	2.5 max.	2.5 max.	watts
GRID-No.2 INPUT	-	0.55 max.	watts
CATHODE CURRENT:			
Peak	-	300 max.	ma
Average	-	20 max.	ma

Maximum Circuit Values (Each Unit):

Grid-No.1-Circuit Resistance: For fixed-bias or cathode-bias operation	2.2 max.	megohms
--	----------	---------

- ^a At heater amperes = 0.450.
- ^b At heater volts = 6.3.
- ^c The dc component must not exceed 100 volts.
- ^d With external shield JEDEC No.315 connected to cathode of unit under test except as noted.
- ^e With external shield JEDEC No.315 connected to ground.
- ^f As described in "Standards of Good Engineering Practice Concerning Television Broadcast Stations," Federal Communications Commission.



INTERELECTRODE LEAKAGE

Leakage Resistance between Plate of Each Unit and All Other Electrodes of both units tied together 100 min. megohms

This test is performed under the following conditions: heater volts = 6.3; and plate 300 volts negative with respect to all other electrodes tied together.

Leakage Resistance between Grid No.1 of Each Unit and All Other Electrodes of both units tied together 100 min. megohms

This test is performed under the following conditions: heater volts = 6.3; and grid 100 volts negative with respect to all other electrodes tied together.



6GH8A

AVERAGE PLATE CHARACTERISTICS Triode Unit

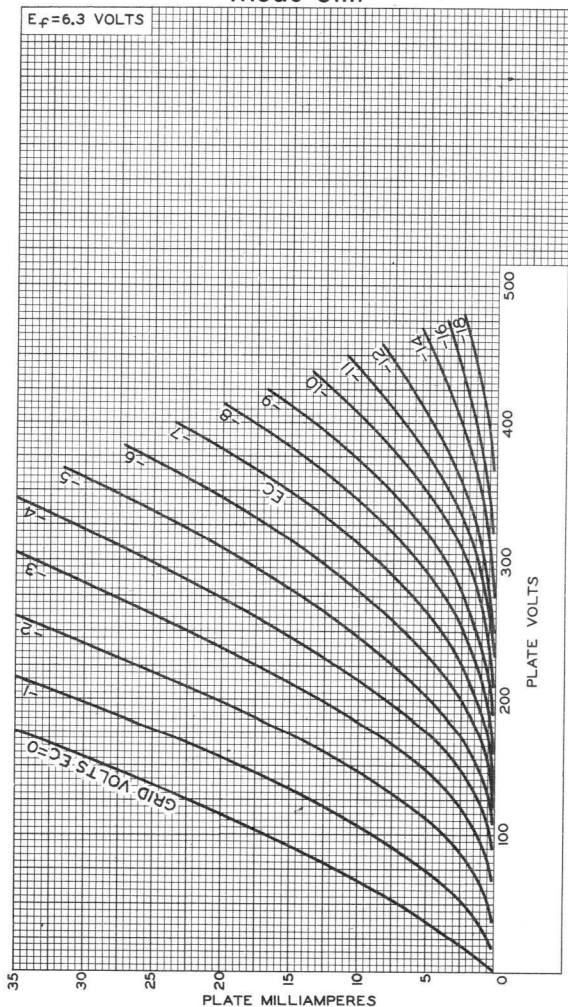

92CM-1042IRI



AVERAGE CHARACTERISTICS Triode Unit

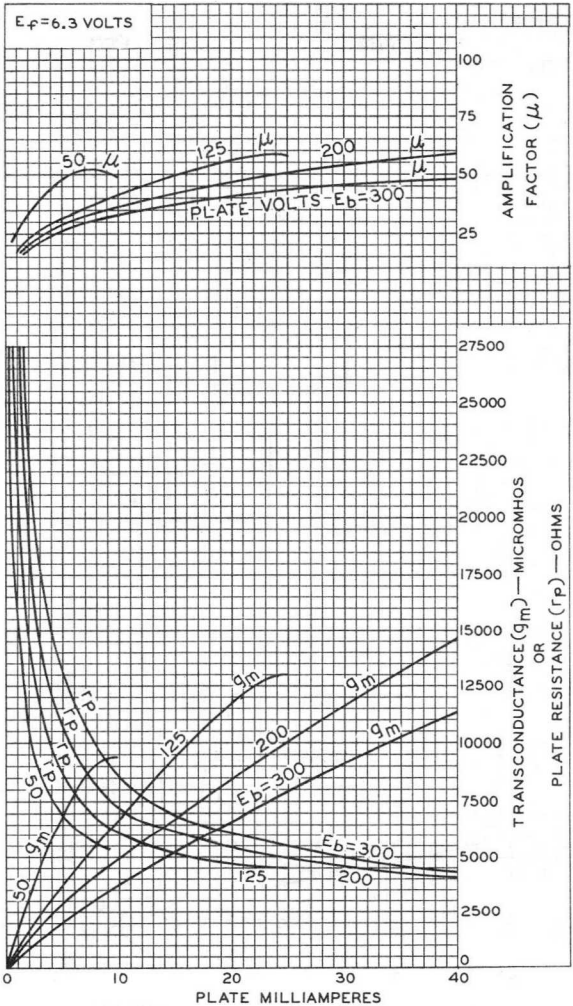

92CM-10428



6GH8A

AVERAGE CHARACTERISTICS Pentode Unit

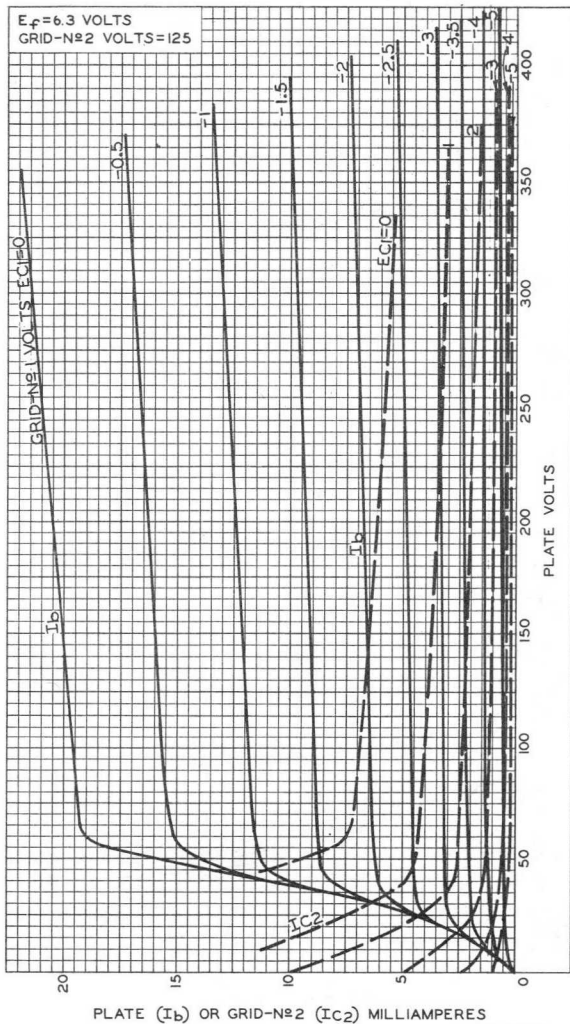

92CM-10436



AVERAGE CHARACTERISTICS Pentode Unit

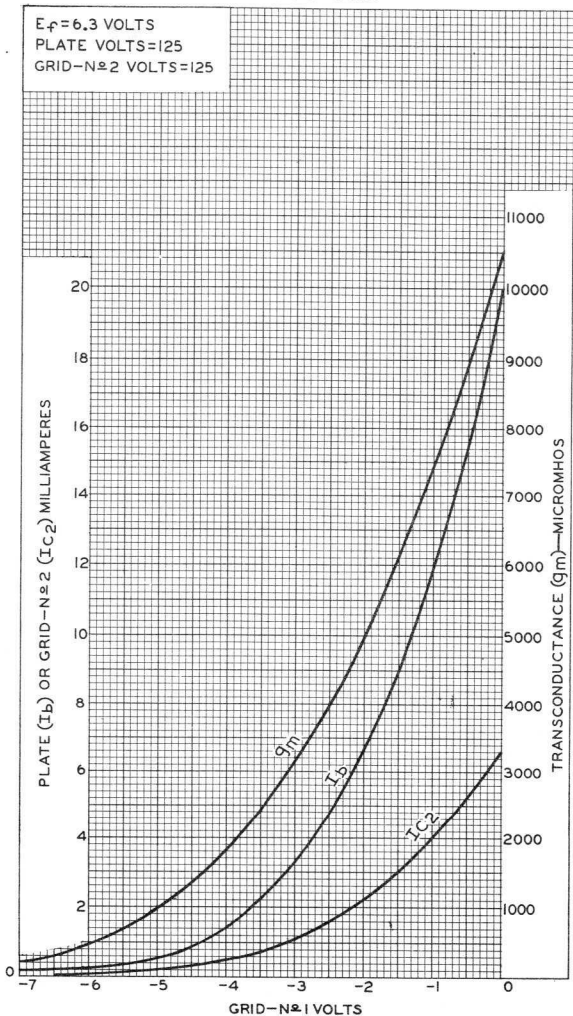

92CM-10417





Beam Power Tube

NOVAR TYPE

For Horizontal-Deflection-Amplifier
Service in Black-and-White TV Receivers

Electrical:

Heater Ratings and Characteristics:

Voltage (AC or DC)	6.3 ± 0.6	volts
Current at heater volts = 6.3	1.200	amp
Peak heater-cathode voltage:		
Heater negative with respect to cathode	200 max.	volts
Heater positive with respect to cathode	200 max. ^a	volts

Direct Interelectrode Capacitances (Approx.):^b

Grid No.1 to plate	0.26	pf
Input: G ₁ to (K, G ₃ , G ₂ , H)	15.0	pf
Output: P to (K, G ₃ , G ₂ , H)	6.5	pf

Mechanical:

Operating Position	Any
Type of Cathode	Coated Unipotential
Maximum Overall Length	3.505"
Seated Length	2.875" to 3.125"
Diameter	1.438" to 1.562"
Dimensional Outline	See <i>General Section</i>
Bulb	T12
Cap	Skirted Miniature (JEDEC C1-2 or C1-3)
Base	Large-Button Novar 9-Pin with Exhaust Tip (JEDEC No. E9-88)

Basing Designation for BOTTOM VIEW. 9QK

- Pin 1-Grid No.2
- Pin 2-Grid No.1
- Pin 3-Cathode,
Grid No.3
- Pin 4-Heater
- Pin 5-Heater
- Pin 6-Grid No.1
- Pin 7-Grid No.2
- Pin 8-No Internal
Connection
- Pin 9-Do Not Use
Cap-Plate

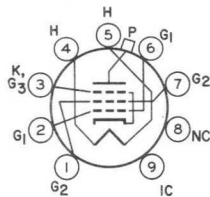

Characteristics, Class A₁ Amplifier:

	Triode Connection	Pentode Connection	
Plate Voltage	150	60 250	volts
Grid-No.2 Voltage	150	150 150	volts
Grid-No.1 Voltage	-22.5	0 -22.5	volts
Mu-factor, Grid No.2 to Grid No.1	4.4	- -	
Plate Resistance (Approx.)	-	- 15000	ohms
Transconductance	-	- 7100	μmhos



6GJ5A

	Triode Connection	Pentode Connection	
Plate Current	-	390 ^c	70 ma
Grid-No.2 Current	-	32 ^c	2.1 ma
Grid-No.1 Voltage (Approx.) for plate ma = 1.	-	-	-42 volts

HORIZONTAL-DEFLECTION AMPLIFIER

Maximum Ratings, Design-Maximum Values:

For operation in a 525-line, 30-frame system^d

DC Plate-Supply Voltage	770	max.	volts
Peak Positive-Pulse Plate Voltage ^e	6500	max.	volts
Peak Negative-Pulse Plate Voltage	1500	max.	volts
DC Grid-No.2 (Screen-Grid) Voltage.	220	max.	volts
DC Grid-No.1 (Control-Grid) Voltage	-55	max.	volts
Peak Negative-Pulse Grid-No.1 Voltage	330	max.	volts
Cathode Current:			
Peak	550	max.	ma
Average	175	max.	ma
Grid-No.2 Input	3.5	max.	watts
Plate Dissipation ^f	17.5	max.	watts
Bulb Temperature (At hottest point on bulb surface).	240	max.	°C

Maximum Circuit Values:

Grid-No.1-Circuit Resistance:			
For grid resistor-bias operation.	1	max.	megohm

^a The dc component must not exceed 100 volts.

^b without external shield.

^c This value can be measured by a method involving a recurrent wave form such that the maximum ratings of the tube will not be exceeded.

^d As described in "Standards of Good Engineering Practice Concerning Television Broadcast Stations," Federal Communications Commission.

^e This rating is applicable where the duration of the voltage pulse does not exceed 15 per cent of one horizontal scanning cycle. In a 525-line, 30-frame system, 15 per cent of one horizontal scanning cycle is 10 microseconds.

^f An adequate bias resistor or other means is required to protect the tube in the absence of excitation.



AVERAGE CHARACTERISTICS

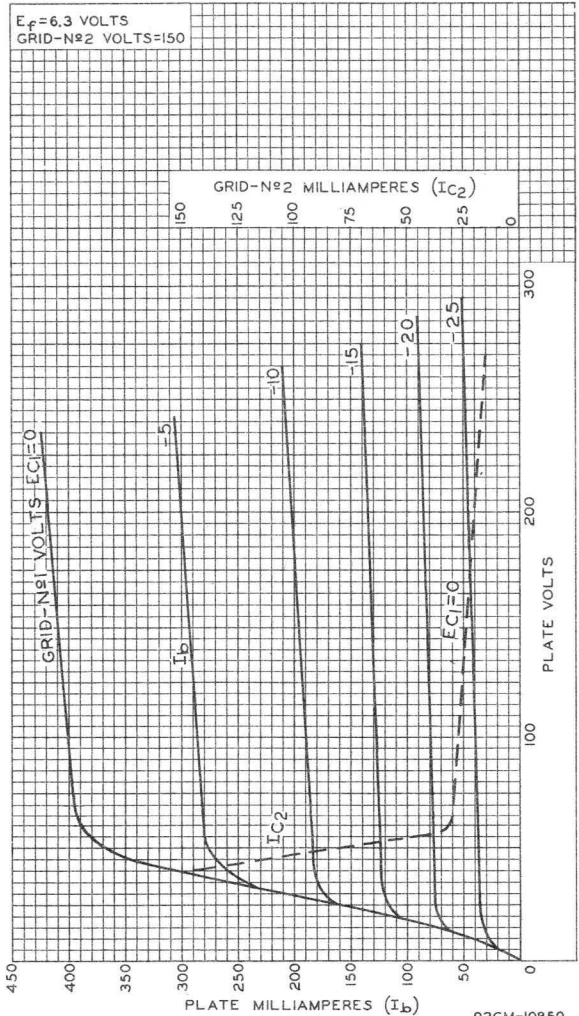



Medium-Mu Triode— Sharp-Cutoff Pentode

ELECTRICAL

Heater Characteristics and Ratings

Voltage (AC or DC)	6.3 ± 0.6	V
Current at 6.3 V	0.410	A
Heater-cathode voltage ^a	110 max	V

Direct Interelectrode Capacitances (Approx.)

<i>Triode Unit</i>		
P _T to G _T	1.8	pF
G _T to K, H	3.3	pF
P _T to all except G _{1p}	1.7	pF
<i>Pentode Unit (With external shield)</i>		
Input	6.2	pF
Output	3.5	pF
P _p to G _{1p}	0.009	pF
G _{1p} to G _{2p}	1.5	pF
<i>Between Triode and Pentode Units</i>		
P _T to P _p	0.025 max	pF
P _p to G _T	0.01 max	pF
P _T to G _{1p}	0.01 max	pF
G _T to G _{1p}	0.01 max	pF

MECHANICAL

Operating Position	Any
Type of Cathode	Coated Unipotential
Maximum Overall Length	2 in
Maximum Seated Length	1-3/4 in
Diameter	0.750 to 0.875 in
Envelope	JEDEC T6-1/2
Base	Small-Button Noval 9-Pin (JEDEC No.E9-1)

TERMINAL DIAGRAM (Bottom View)

- Pin 1—Cathode, Pentode
Grid No.3, Internal Shield
- Pin 2—Pentode Grid No.1
- Pin 3—Same as Pin 1
- Pin 4—Heater
- Pin 5—Heater
- Pin 6—Pentode Plate
- Pin 7—Pentode Grid No.2
- Pin 8—Triode Plate
- Pin 9—Triode Grid

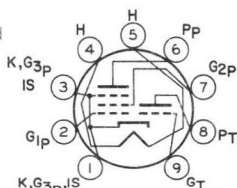

9QA

CHARACTERISTICS

	<i>Triode Unit</i>	<i>Pentode Unit</i>	
Plate Voltage	100	170	V
Grid-No.2 Voltage	-	120	V
Grid-No.1 Voltage	-3	-1.2	V
Amplification Factor	20	55 ^b	



	Triode Unit	Pentode Unit	
Plate Resistance (Approx.)	-	0.35	MΩ
Transconductance	9000	11000	μmhos
Plate Current.	15	10	mA
Grid No.2 Current.	-	3	mA

DESIGN-MAXIMUM RATINGS

	Triode Unit	Pentode Unit	
Plate-Supply Voltage	600	600	V
DC Plate Voltage	140	275	V
Grid-No.2 Supply Voltage	-	600	V
DC Grid-No.2 (Screen-Grid) Voltage . .	-	275	V
DC Grid-No.1 (Control-Grid) Voltage. .	-	-50	V
Cathode Current.	22	20	mA
Plate Dissipation.	1.8	2.4	W
Grid-No.2 Input ^c	-	0.55	W

MAXIMUM CIRCUIT VALUES

Grid-No.1-Circuit Resistance			
For fixed-bias operation	0.5	1	MΩ
For cathode-bias operation	0.5	2.2	MΩ

^a The hum should be minimized in intercarrier receiver applications by limiting the heater-cathode voltage to 100 volts rms, and in AM receivers to 50 volts rms.

^b Grid No.2 to grid No.1; approximate value.

^c When control grid bias is between -1.5 and -2 volts, screen dissipation is limited to 0.50 watt. When this bias is greater than -2 volts, maximum screen dissipation is 0.36 watt.



High-Mu Triode

7-PIN MINIATURE TYPE
For VHF-Amplifier Applications

GENERAL DATA

Electrical:

Heater, for Unipotential Cathode:

Voltage (AC or DC)	6.3 ± 10%	volts
Current at 6.3 volts.	0.18	amp
Direct Interelectrode Capacitances (Approx.): ^a		
Grid to plate	0.52	μμf
Grid to cathode, internal shield, and heater.	5	μμf
Plate to cathode, internal shield, and heater.	3.5	μμf
Heater to cathode	2.5 ^b	μμf

Characteristics, Class A₁ Amplifier:

Plate Voltage	135	volts
Grid Voltage.	-1	volt
Amplification Factor.	78	
Plate Resistance (Approx.).	5400	ohms
Transconductance.	15000	μμhos
Plate Current	11.5	ma
Grid Voltage (Approx.) for transconductance (μμhos) =		
150	-4.2	volts
1500.	-2.5	volts
Input Resistance ^c	275	ohms
Input Capacitance ^c	11.2	μμf
Noise Figure ^d	4.7	db

Mechanical:

Operating Position.	Any
Maximum Overall Length.	2-1/8"
Maximum Seated Length	1-7/8"
Length, Base Seat to Bulb Top (Excluding tip)	1-1/2" ± 3/32"
Diameter.	0.650" to 0.750"
Dimensional Outline	See <i>General Section</i>
Bulb.	T5-1/2
Base.	Small-Button Miniature 7-Pin (JEDEC No. E7-1)
Basing Designation for BOTTOM VIEW.	7FP

Pin 1 - Cathode
Pin 2 - Grid
Pin 3 - Heater
Pin 4 - Heater

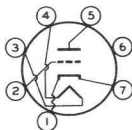

Pin 5 - Plate
Pin 6 - Internal Shield
Pin 7 - Cathode



6GK5

AMPLIFIER — Class A₁

Maximum Ratings, Design-Maximum Values:

PLATE VOLTAGE.	200 max.	volts
GRID VOLTAGE:		
Negative-bias value.	50 max.	volts
Positive-bias value.	0 max.	volts
AVERAGE CATHODE CURRENT.	22 max.	ma
PLATE DISSIPATION.	2.5 max.	watts
PEAK HEATER-CATHODE VOLTAGE:		
Heater negative with respect to cathode. .	100 max.	volts
Heater positive with respect to cathode. .	100 max.	volts

Maximum Circuit Values:

Grid-Circuit Resistance:

For cathode-bias operation 1 max. megohm

- a With external shield JEDEC No.316 connected to cathode except as noted.
- b With external shield JEDEC No.316 and internal shield connected to ground.
- c Measured at 200 Mc with heater volts = 6.3 and plate effectively grounded for rf voltages.
- d For a neutralized triode amplifier at a frequency of 200 Mc with signal-source impedance adjusted for minimum noise output.



AVERAGE PLATE CHARACTERISTICS

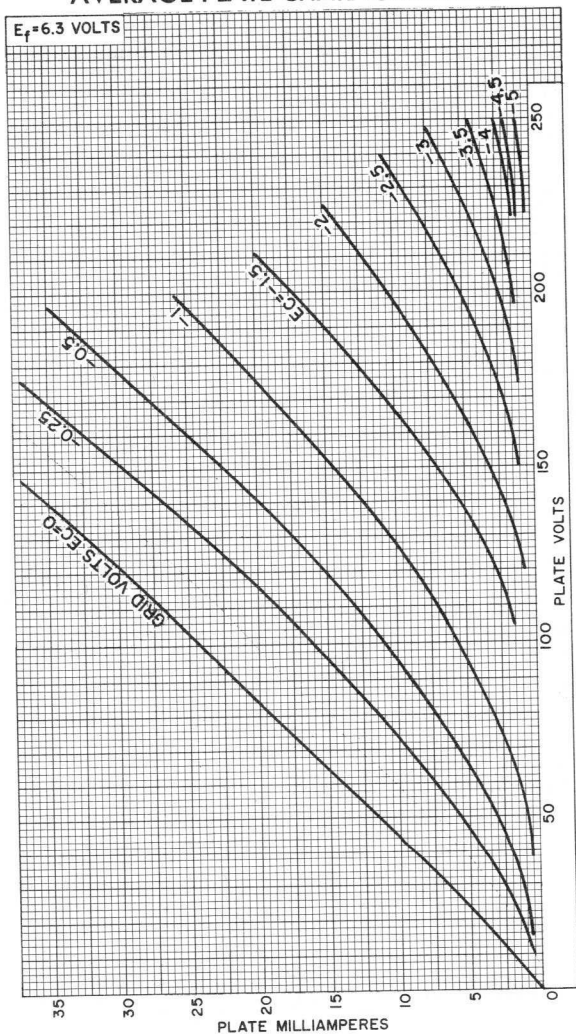

92CM-11024



6GK5

AVERAGE CHARACTERISTICS

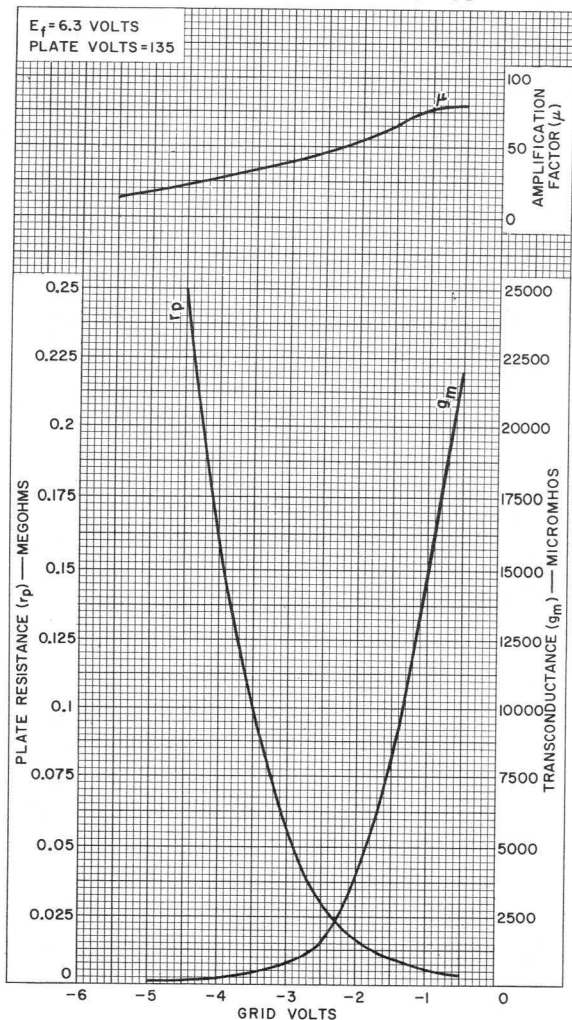

92CM-11023



Power Pentode

9-PIN MINIATURE TYPE

GENERAL DATA

Electrical:

Heater, for Unipotential Cathode:

Voltage (AC or DC)	6.3 ± 10%	volts
Current at 6.3 volts.	0.76	amp

Direct Interelectrode Capacitances:^a

Grid No.1 to plate.	0.14 max.	μf
Grid No.1 to cathode, grid No.3 & internal shield, grid No.2, and heater.	10	μf
Plate to cathode, grid No.3 & internal shield, grid No.2, and heater.	7	μf

Characteristics, Class A₁ Amplifier:

Plate Supply Voltage.	250	volts
Grid-No.2 Supply Voltage.	250	volts
Cathode Resistor.	135	ohms
Mu-Factor, Grid No.2 to Grid No.1	19	
Plate Resistance (Approx.).	38000	ohms
Transconductance.	11300	μmhos
Plate Current	48	ma
Grid-No.2 Current	5.5	ma

Mechanical:

Operating Position.	Any
Maximum Overall Length.	3-1/16"
Maximum Seated Length	2-13/16"
Length, Base Seat to Bulb Top (Excluding tip)	2-7/16" ± 3/32"
Diameter.	0.750" to 0.875"
Dimensional Outline	See <i>General Section</i>
Bulb.	T6-1/2
Base.	Small-Button Noval 9-Pin (JEDEC No.E9-1)
Basing Designation for BOTTOM VIEW.	9GK

- Pin 1 - Cathode
- Pin 2 - Grid No.1
- Pin 3 - Grid No.3,
Internal
Shield
- Pin 4 - Heater
- Pin 5 - Heater

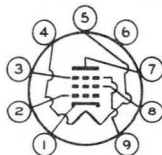

- Pin 6 - No Connection
- Pin 7 - Plate
- Pin 8 - Grid No.2
- Pin 9 - Grid No.3,
Internal
Shield

AF POWER AMPLIFIER — Class A₁

Maximum Ratings, Design-Maximum Values:

PLATE SUPPLY VOLTAGE.	600 max.	volts
PLATE VOLTAGE	330 max.	volts
GRID-No.2 SUPPLY VOLTAGE.	600 max.	volts
GRID-No.2 (SCREEN-GRID) VOLTAGE	330 max.	volts



6GK6

GRID-No.1 (CONTROL-GRID) VOLTAGE:

Negative-bias value	100 max.	volts
CATHODE CURRENT	65 max.	ma

GRID-No.2 INPUT:

Peak	4 max.	watts
Average	2 max.	watts

PLATE DISSIPATION	13.2 max.	watts
-----------------------------	-----------	-------

PEAK HEATER-CATHODE VOLTAGE:

Heater negative with respect to cathode.	100 max.	volts
Heater positive with respect to cathode.	100 max.	volts

Typical Operation:

Plate Supply Voltage	250	volts
Grid-No.2 Supply Voltage	250	volts
Cathode Resistor	135	ohms
Peak AF Grid-No.1 Voltage	7.3	volts
Zero-Signal Plate Current	48	ma
Max.-Signal Plate Current	50.6	ma
Zero-Signal Grid-No.2 Current	5.5	ma
Max.-Signal Grid-No.2 Current	10	ma
Effective Load Resistance	5200	ohms
Total Harmonic Distortion	10	%
Max.-Signal Power Output	5.7	watts

Maximum Circuit Values:

Grid-No.1-Circuit Resistance:

For fixed-bias operation	0.3 max.	megohm
For cathode-bias operation	1 max.	megohm

PUSH-PULL AF POWER AMPLIFIER — Class AB₁

Maximum Ratings, Design-Maximum Values:

PLATE SUPPLY VOLTAGE	600 max.	volts
PLATE VOLTAGE	330 max.	volts
GRID-No.2 SUPPLY VOLTAGE	600 max.	volts
GRID-No.2 (SCREEN-GRID) VOLTAGE	330 max.	volts

GRID-No.1 (CONTROL-GRID) VOLTAGE:

Negative-bias value	100 max.	volts
CATHODE CURRENT	65 max.	ma

GRID-No.2 INPUT:

Peak	4 max.	watts
Average	2 max.	watts

PLATE DISSIPATION	13.2 max.	watts
-----------------------------	-----------	-------

PEAK HEATER-CATHODE VOLTAGE:

Heater negative with respect to cathode.	100 max.	volts
Heater positive with respect to cathode.	100 max.	volts

Typical Operation:

Values are for 2 tubes

Plate Supply Voltage	250	300	volts
Grid-No.2 Supply Voltage	250	300	volts
Cathode Resistor	130	130	ohms
Peak AF Grid-No.1-to-Grid-No.1 Voltage	22.4	28	volts
Zero-Signal Plate Current	62	72	ma



Max.-Signal Plate Current	75	92	ma
Zero-Signal Grid-No.2 Current	7	8	ma
Max.-Signal Grid-No.2 Current	15	22	ma
Effective Load Resistance (Plate to plate).	8000	8000	ohms
Total Harmonic Distortion	3	4	%
Max.-Signal Power Output.	11	17	watts

Maximum Circuit Values:

Grid-No.1-Circuit Resistance:

For fixed-bias operation.	0.3 max.	megohm
For cathode-bias operation.	1 max.	megohm

PUSH-PULL AF POWER AMPLIFIER — Class B

Maximum Ratings, Design-Maximum Values:

PLATE SUPPLY VOLTAGE.	600 max.	volts
PLATE VOLTAGE	330 max.	volts
GRID-No.2 SUPPLY VOLTAGE.	600 max.	volts
GRID-No.2 (SCREEN-GRID) VOLTAGE	330 max.	volts
GRID-No.1 (CONTROL-GRID) VOLTAGE:		
Negative-bias value	100 max.	volts
CATHODE CURRENT	65 max.	ma
GRID-No.2 INPUT:		
Peak.	4 max.	watts
Average	2 max.	watts
PLATE DISSIPATION	13.2 max.	watts
PEAK HEATER-CATHODE VOLTAGE:		
Heater negative with respect to cathode. .	100 max.	volts
Heater positive with respect to cathode. .	100 max.	volts

Typical Operation:

Values are for 2 tubes

Plate Voltage	250	300	volts
Grid-No.2 Voltage	250	300	volts
Grid-No.1 Voltage	-11.6	-14.7	volts
Peak AF Grid-No.1-to-Grid-No.1 Voltage. .	22.4	28	volts
Zero-Signal Plate Current	20	15	ma
Max.-Signal Plate Current	75	92	ma
Zero-Signal Grid-No.2 Current	2.2	1.6	ma
Max.-Signal Grid-No.2 Current	15	22	ma
Effective Load Resistance (Plate to plate).	8000	8000	ohms
Total Harmonic Distortion	3	4	%
Max.-Signal Power Output.	11	17	watts

Maximum Circuit Values:

Grid-No.1-Circuit Resistance:

For fixed-bias operation.	0.3 max.	megohm
For cathode-bias operation.	1 max.	megohm

^a Without external shield.



6GK6

AVERAGE CHARACTERISTICS

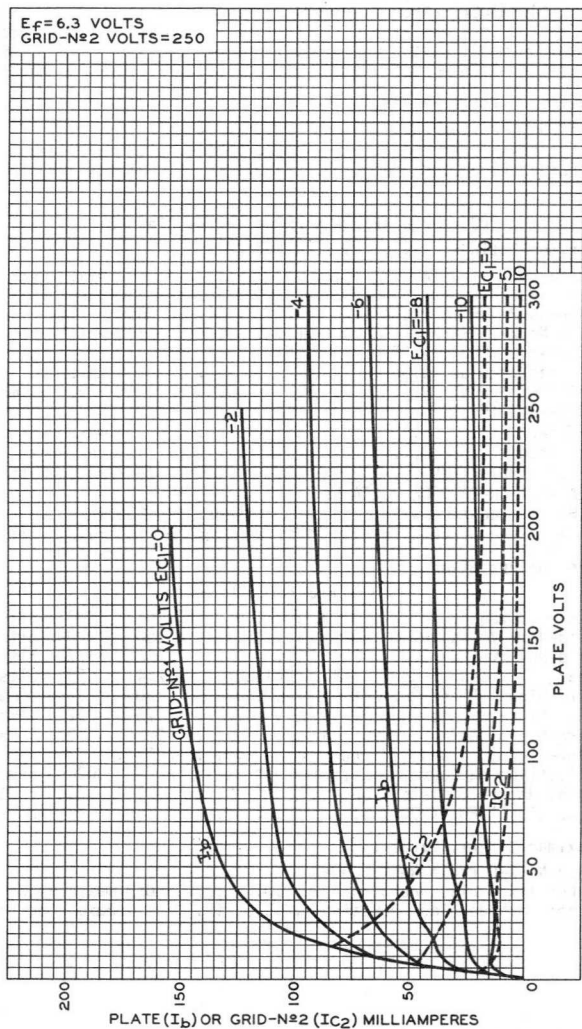

92CM-9903



OPERATION CHARACTERISTICS

$E_c = 6.3$ VOLTS
 PLATE VOLTS = 250
 GRID-N₂ VOLTS = 250
 GRID-N₁ VOLTS = -7.3
 AF GRID-N₁ VOLTS
 (RMS) = 4.4

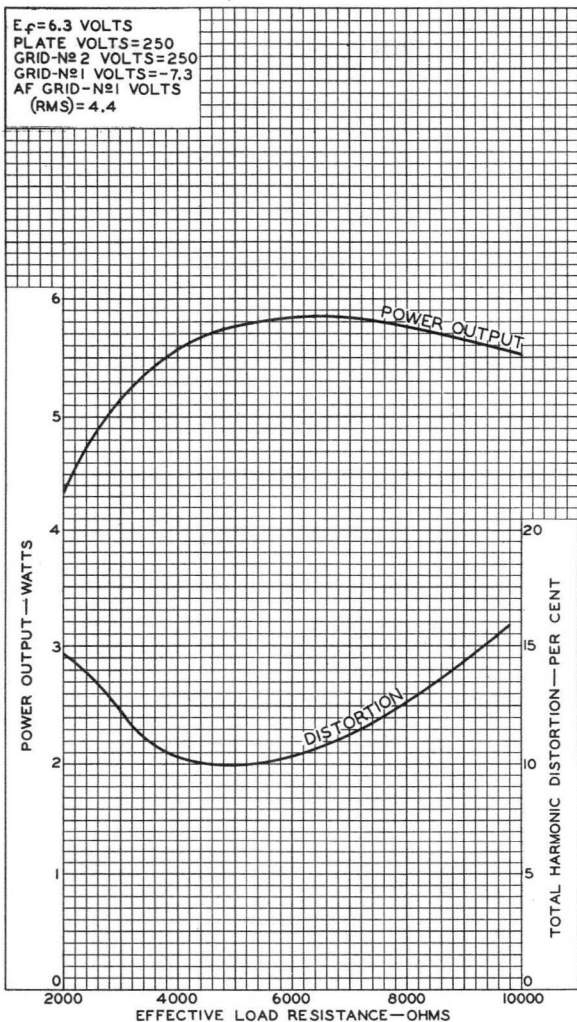

92CM-9902



5250



Dual Triode With High-Mu Unit and Low-Mu Unit

GENERAL DATA

Electrical:

Heater Characteristics and Ratings:

Voltage (AC or DC)	6.3 ± 0.6	volts
Current at heater volts = 6.3	1.05	amp
Peak heater-cathode voltage (Each unit):		
Heater negative with		
respect to cathode	200 max.	volts
Heater positive with		
respect to cathode	200 ^a max.	volts

Direct Interelectrode Capacitances (Approx.):^b

	Unit No. 1	Unit No. 2	
Grid to plate.	4.0	8.0	pf
Grid to cathode and heater .	2.2	6.0	pf
Plate to cathode and heater.	0.6	1.3	pf

Characteristics, Class A₁ Amplifier:

	Unit No. 1		Unit No. 2		
Plate Voltage.	250	275	60	175	volts
Grid Voltage	-3	^c	0 ^d	-25	volts
Amplification Factor	66	-	-	5	
Plate Resistance (Approx.) . .	30000	-	-	780	ohms
Transconductance	2200	1600	-	6400	μhos
Plate Current.	2	13	100	46	ma
Grid Voltage (Approx.) for					
plate μa =					
20	-5.3	-	-	-	volts
200.	-	-	-	-60	volts

Mechanical:

Operating Position	Any
Type of Cathodes	Coated Unipotential
Maximum Overall Length	3"
Maximum Seated Length.	2-7/16"
Maximum Diameter	1-9/32"
Bulb	T9
Base	Intermediate-Shell Octal 8-Pin, (JEDEC Group 1, No. B8-6)

Basing Designation for BOTTOM VIEW 8BD

Pin 1 - Grid of Unit No. 2	Pin 5 - Plate of Unit No. 1
Pin 2 - Plate of Unit No. 2	Pin 6 - Cathode of Unit No. 1
Pin 3 - Cathode of Unit No. 2	Pin 7 - Heater
Pin 4 - Grid of Unit No. 1	Pin 8 - Heater

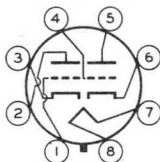

VERTICAL-DEFLECTION OSCILLATOR

Values are for Unit No. 1

Maximum Ratings, Design-Maximum Values:

For operation in a 525-line, 30-frame system^e

DC PLATE VOLTAGE.	350 max.	volts
PEAK NEGATIVE-PULSE GRID VOLTAGE.	400 max.	volts
PLATE DISSIPATION	1 max.	watt

Maximum Circuit Values:

Grid-Circuit Resistance:

For fixed-bias operation.	1 max.	megohm
For cathode-bias operation.	2.2 max.	megohms

VERTICAL-DEFLECTION AMPLIFIER

Values are for Unit No. 2

Maximum Ratings, Design-Maximum Values:

For operation in a 525-line, 30-frame system^e

DC PLATE VOLTAGE.	550 max.	volts
PEAK POSITIVE-PULSE PLATE VOLTAGE ^f	1500 max.	volts
PEAK NEGATIVE-PULSE GRID VOLTAGE.	250 max.	volts
CATHODE CURRENT:		
Peak.	175 max.	ma
Average	50 max.	ma
PLATE DISSIPATION	10 ^g max.	watts

Maximum Circuit Values:

Grid-Circuit Resistance:

For fixed-bias operation.	1 max.	megohm
For cathode-bias operation.	2.2 max.	megohms

^a The dc component must not exceed 100 volts.

^b Without external shield.

^c Adjusted for plate ma.=13.

^d Applied for short interval (two seconds maximum) so as not to damage tube.

^e As described in "Standards of Good Engineering Practice Concerning Television Broadcast Stations," Federal Communications Commission.

^f This rating is applicable when the duration of the voltage pulse does not exceed 15 per cent of one vertical scanning cycle. In a 525-line, 30-frame system, 15 per cent of one vertical scanning cycle is 2.5 milli-seconds.

^g In stages operating with grid-leak bias, an adequate cathode-bias resistor or other suitable means is required to protect the tube in the absence of excitation.



6GL7

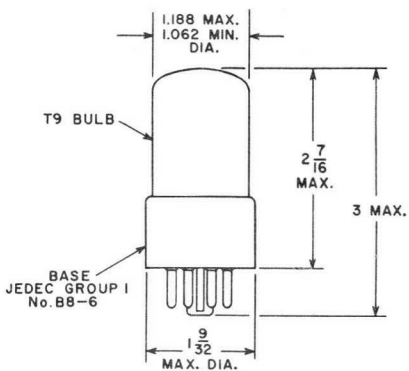

ALL DIMENSIONS IN INCHES



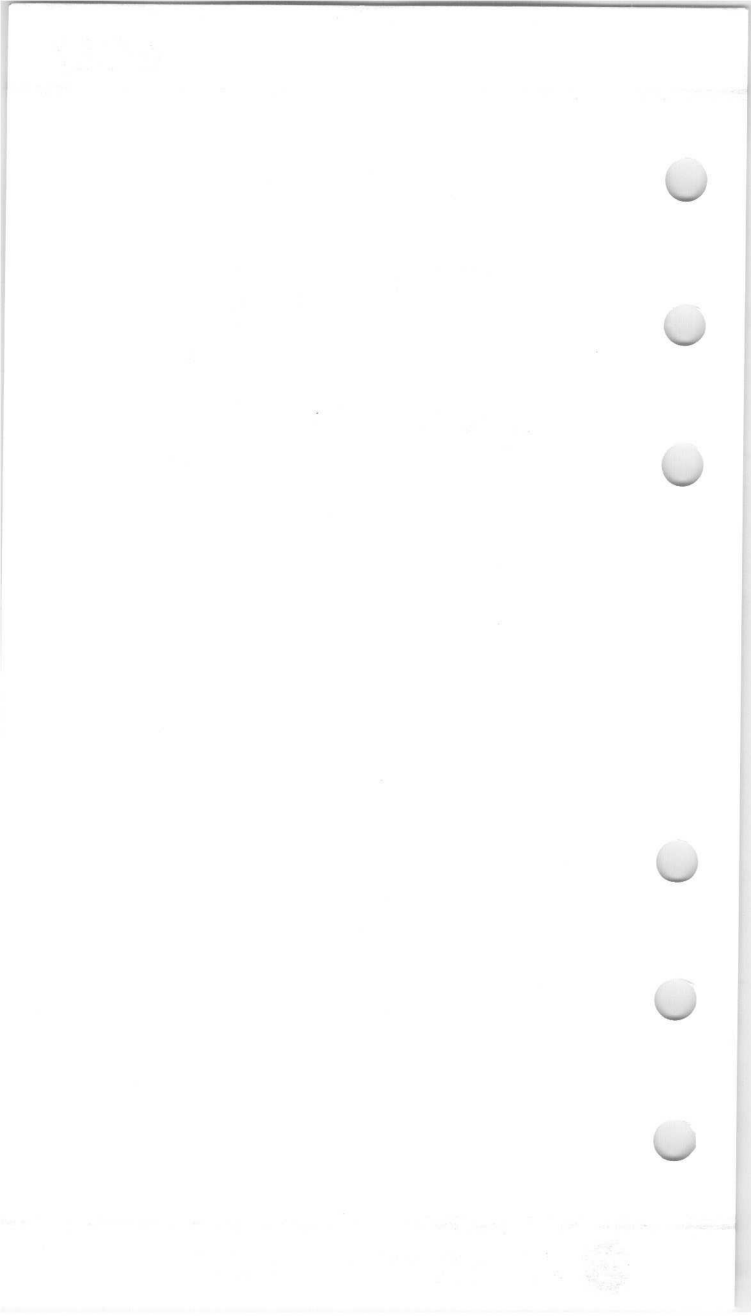

Semiremote-Cutoff Pentode

7-PIN MINIATURE TYPE

For Gain-Controlled, 40-Mc, Picture-IF Stages of TV Receivers

GENERAL DATA

Electrical:

Heater, for Unipotential Cathode:

Voltage (AC or DC)	6.3 ± 10%	volts
Current at 6.3 volts	0.4	amp

Direct Interelectrode Capacitances:

	Without External Shield	With External Shield [▲]	
Grid No.1 to plate	0.036 max.	0.026 max.	μf
Grid No.1 to cathode, grid No.3 & internal shield, grid No.2, and heater . . .	10	10	μf
Plate to cathode, grid No.3 & internal shield, grid No.2, and heater	2.4	3.4	μf

Characteristics, Class A₁ Amplifier:

Plate Supply Voltage	125	volts
Grid No.3 and Internal Shield	<i>Connected to cathode at socket</i>	
Grid-No.2 Supply Voltage	125	volts
Cathode Resistor	56	ohms
Plate Resistance (Approx.)	0.2	megohm
Transconductance	13000	μmhos
Plate Current	14	ma
Grid-No.2 Current	3.4	ma
Grid-No.1 Voltage (Approx.) for transconductance (μmhos) = 60	-15	volts

Mechanical:

Operating Position	Any
Maximum Overall Length	2-1/8"
Maximum Seated Length	1-7/8"
Length, Base Seat to Bulb Top (Excluding tip)	1-1/2" ± 3-32"
Diameter	0.650" to 0.750"
Dimensional Outline	See <i>General Section</i>
Bulb	T5-1/2
Base	Small-Button Miniature 7-Pin (JEDEC No.E7-1)
Basing Designation for BOTTOM VIEW	7CM

Pin 1 - Grid No.1
Pin 2 - Cathode
Pin 3 - Heater
Pin 4 - Heater
Pin 5 - Plate

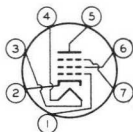

Pin 6 - Grid No.2
Pin 7 - Grid No.3,
Internal
Shield



6GM6

AMPLIFIER — Class A₁

Maximum Ratings, Design-Maximum Values:

PLATE VOLTAGE. 330 max. volts

GRID No.3 (SUPPRESSOR GRID). . . *Connect to cathode at socket*

GRID-No.2 (SCREEN-GRID) SUPPLY VOLTAGE . . . 330 max. volts

GRID-No.2 VOLTAGE. *See Grid-No.2 Input*

Rating Chart at front of Receiving Tube Section

GRID-No.1 (CONTROL-GRID) VOLTAGE:

Positive-bias value. 0 max. volts

GRID-No.2 INPUT:

For grid-No.2 voltages up

to 165 volts 0.65 max. watt

For grid-No.2 voltages be-

tween 165 and 330 volts. *See Grid-No.2 Input*

Rating Chart at front of Receiving Tube Section

PLATE DISSIPATION. 3.1 max. watts

PEAK HEATER-CATHODE VOLTAGE:

Heater negative with respect to cathode. 200 max. volts

Heater positive with respect to cathode. 200[•] max. volts

▲ With external shield JEDEC No.316 connected to cathode.

● The dc component must not exceed 100 volts.

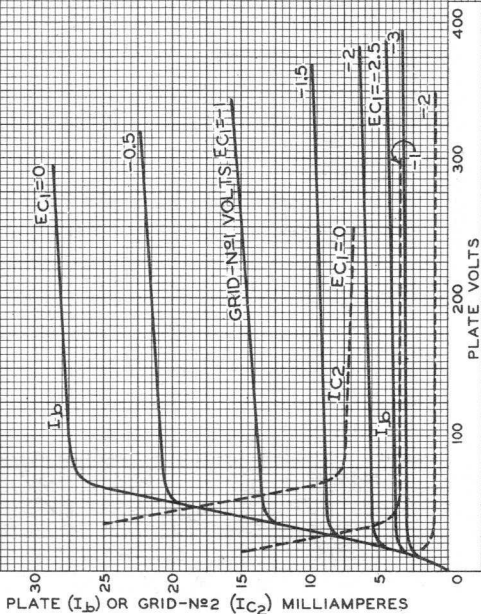

AVERAGE CHARACTERISTICS

 $E_f = 6.3$ VOLTSGRID N^o3 AND INTERNAL SHIELD CONNECTED
TO CATHODE AT SOCKET.GRID-N^o2 VOLTS=125

92CM-10390RI



6GM6

AVERAGE CHARACTERISTICS

$E_f = 6.3$ VOLTS
PLATE VOLTS = 125
GRID N^o3 AND INTERNAL SHIELD CONNECTED
TO CATHODE AT SOCKET.
GRID-N^o2 VOLTS = 125

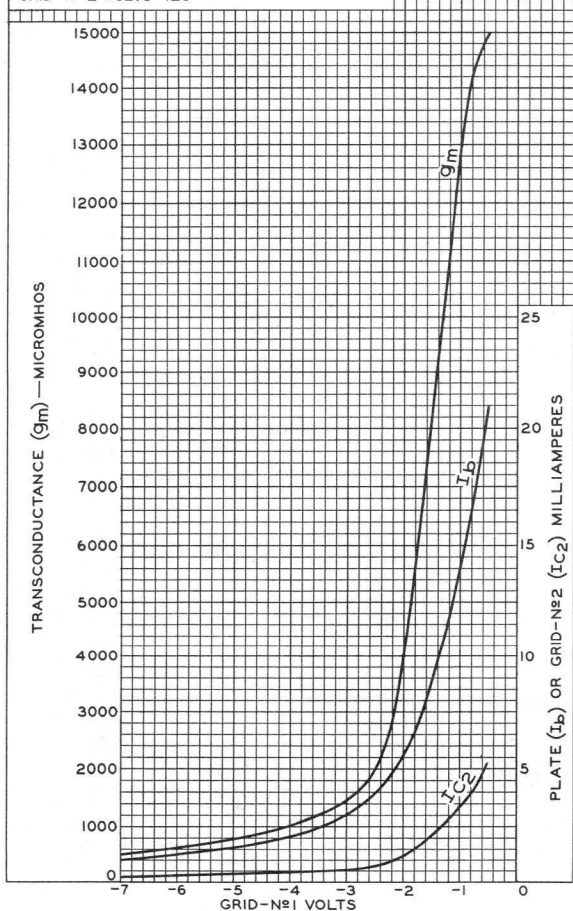

92CM-1039IRI



High-Mu Triode— Sharp-Cutoff Pentode

9-PIN MINIATURE TYPE

GENERAL DATA

Electrical:

Heater, for Unipotential Cathodes:

Voltage (AC or DC)	6.3 ± 10%	volts
Current at 6.3 volts	0.75	amp

Direct Interelectrode Capacitances:^a

Triode Unit:

Grid to plate	4.4	μf
Grid to cathode and heater	2.4	μf
Plate to cathode and heater	0.36	μf

Pentode Unit:

Grid No.1 to plate	0.1 max.	μf
Grid No.1 to cathode & internal shield & grid No.3, grid No.2, and heater.	11	μf
Plate to cathode & internal shield & grid No.3, grid No.2, and heater.	4.2	μf
Triode grid to pentode plate	0.018 max.	μf
Pentode grid No.1 to triode plate	0.005 max.	μf
Pentode plate to triode plate	0.17 max.	μf

Characteristics, Class A₁ Amplifier:

	Triode Unit	Pentode Unit	
Plate Supply Voltage	250	60 200	volts
Grid-No.2 Supply Voltage	—	150 150	volts
Grid-No.1 Voltage	-2	0 —	volts
Cathode Resistor	—	— 100	ohms
Amplification Factor	100	— —	
Plate Resistance (Approx.)	37000	— 60000	ohms
Transconductance	2700	— 11500	μmhos
Plate Current	2	55 ^b 25	ma
Grid-No.2 Current	—	18 ^b 5.5	ma
Grid-No.1 Voltage (Approx.) for plate μa = 100	—	— -10	volts
Grid Voltage (Approx.) for plate μa = 20	-5	— —	volts

Mechanical:

Operating Position	Any
Maximum Overall Length	2-5/8"
Maximum Seated Length	2-3/8"
Length, Base Seat to Bulb Top (Excluding tip)	2" ± 3/32"
Diameter	0.750" to 0.875"
Dimensional Outline	See General Section
Bulb	T6-1/2



6GN8

Base Small-Button Noval 9-Pin (JEDEC No. E9-1)
 Basing Designation for BOTTOM VIEW. 9DX

Pin 1 - Triode
 Cathode
 Pin 2 - Triode
 Grid
 Pin 3 - Triode
 Plate
 Pin 4 - Heater
 Pin 5 - Heater

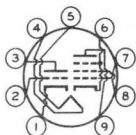

Pin 6 - Pentode
 Cathode,
 Grid No. 3,
 Internal
 Shield
 Pin 7 - Pentode
 Grid No. 1
 Pin 8 - Pentode
 Grid No. 2
 Pin 9 - Pentode
 Plate

AMPLIFIER — Class A₁

Maximum Ratings, Design-Maximum Values:

	<i>Triode Unit</i>	<i>Pentode Unit</i>	
PLATE VOLTAGE	330 max.	330 max.	volts
GRID-No. 2 (SCREEN-GRID) SUPPLY VOLTAGE	-	330 max.	volts
GRID-No. 2 VOLTAGE	-	See <i>Grid-No. 2 Input</i>	

Rating Chart at front of Receiving Tube Section

GRID-No. 1 (CONTROL-GRID) VOLTAGE:			
Positive-bias value	0 max.	0 max.	volts
PLATE DISSIPATION	1 max.	5 max.	watts
GRID-No. 2 INPUT:			
For grid-No. 2 voltages up to 165 volts	-	1.1 max.	watts
For grid-No. 2 voltages between 165 and 330 volts		See <i>Grid-No. 2 Input</i>	

Rating Chart at front of Receiving Tube Section

PEAK HEATER-CATHODE VOLTAGE:			
Heater negative with respect to cathode.	200 max.	200 max.	volts
Heater positive with respect to cathode.	200 ^c max.	200 ^c max.	volts

Maximum Circuit Values:

	<i>Triode Unit</i>	<i>Pentode Unit</i>	
Grid-No. 1-Circuit Resistance:			
For fixed-bias operation.	0.5 max.	0.25 max.	megohm
For cathode-bias operation.	1 max.	1 max.	megohm

^a Without external shield.

^b This value can be measured by a method involving a recurrent wave form such that the maximum ratings of the tube will not be exceeded.

^c The dc component must not exceed 100 volts.



AVERAGE PLATE CHARACTERISTICS Triode Unit

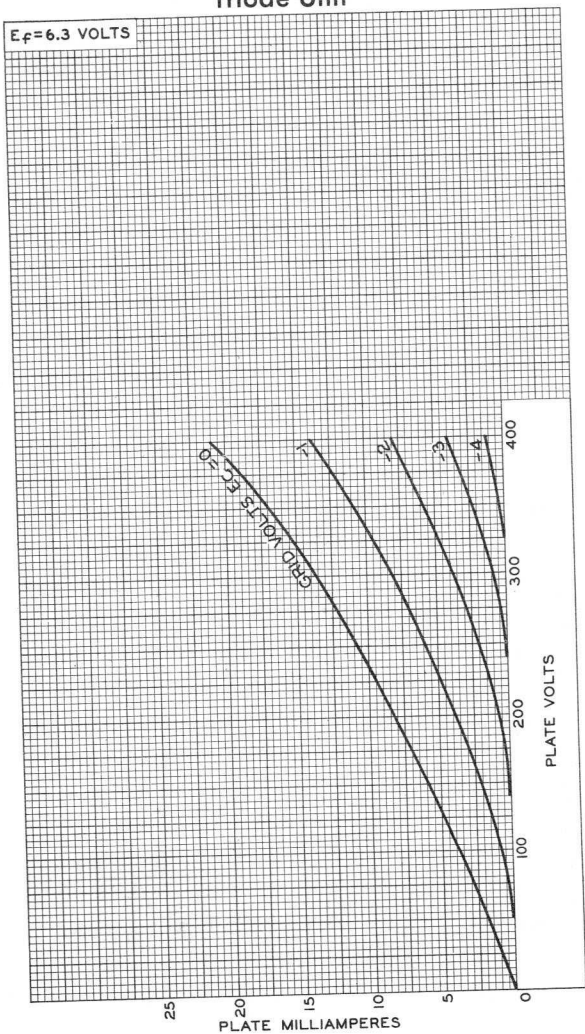

92CM-9907R1



6GN8

AVERAGE CHARACTERISTICS Triode Unit

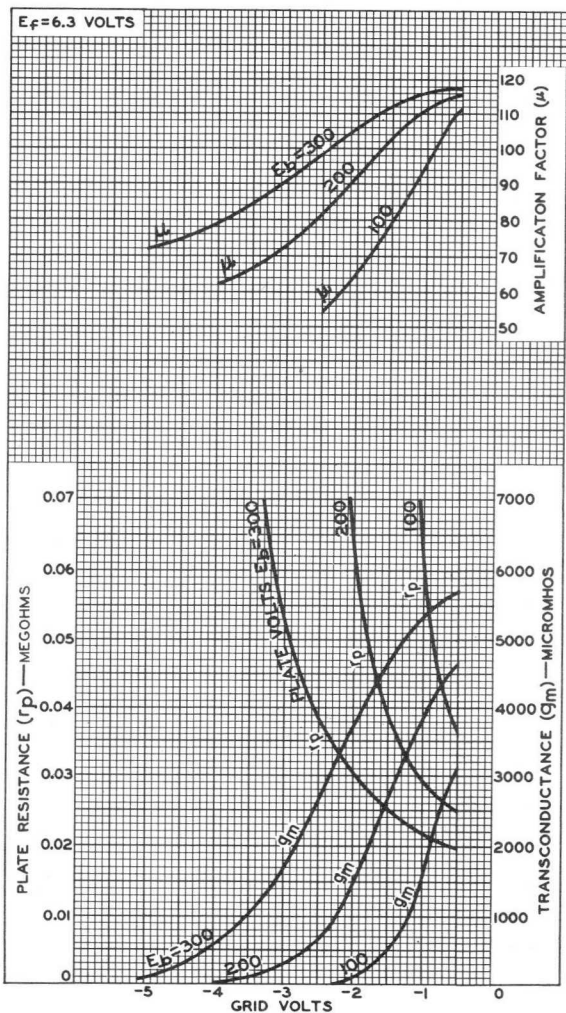

92CM-11025

RADIO CORPORATION OF AMERICA
Electron Tube Division

Harrison, N. J.



AVERAGE CHARACTERISTICS Pentode Unit

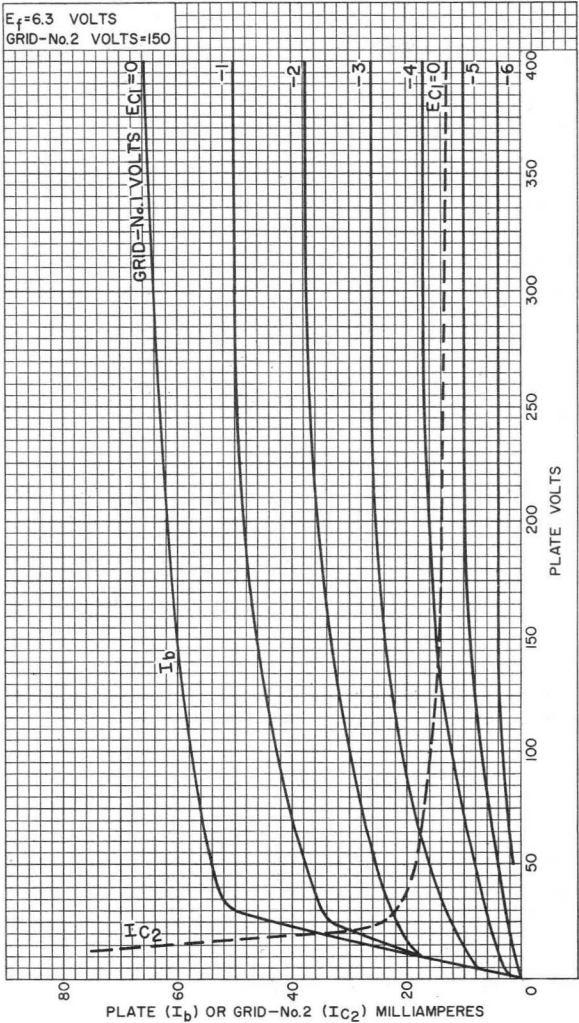

6GN8

AVERAGE CHARACTERISTICS Pentode Unit

$E_f = 6.3$ VOLTS
PLATE VOLTS = 200
GRID-NO. 2 VOLTS = 150

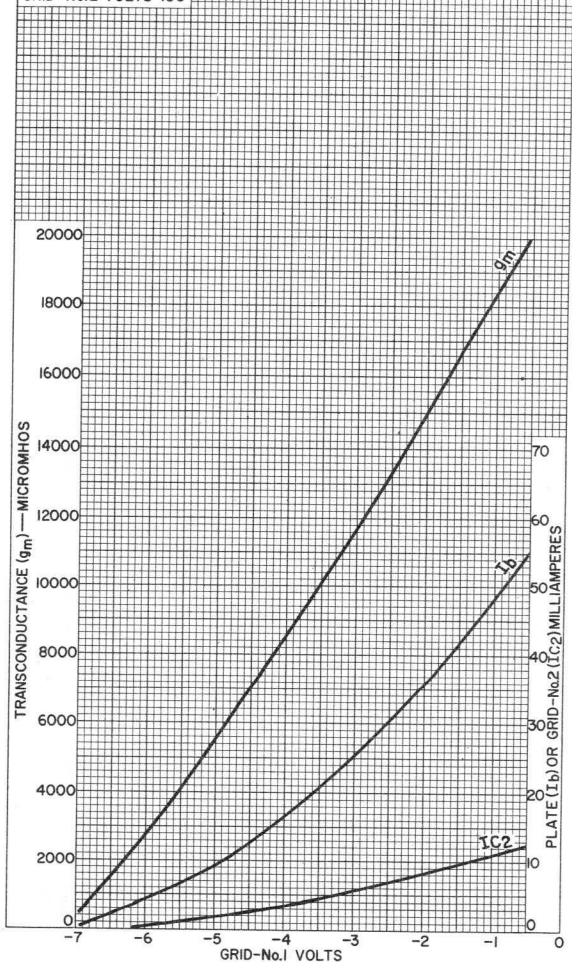

92CM-11022

RADIO CORPORATION OF AMERICA
Electron Tube Division

Harrison, N. J.



Beam Power Tube

NOVAR TYPE

For TV Horizontal-Deflection-Amplifier Applications

GENERAL DATA

Electrical:

Heater Characteristics and Ratings:

Voltage (AC or DC)	6.3 ± 0.6	volts
Current at heater volts = 6.3	1.200	amp
Peak heater-cathode voltage:		
Heater negative with respect to cathode	200 max.	volts
Heater positive with respect to cathode	200 ^a max.	volts

Direct Interelectrode Capacitances (Approx.):^b

Grid No.1 to plate	0.26	pf
Grid No.1 to cathode & grid No.3, grid No.2, and heater	15.0	pf
Plate to cathode & grid No.3, grid No.2, and heater	6.5	pf

Characteristics, Class A₁ Amplifier:

		Triode Connection ^c		
Plate Voltage	60	250	150	volts
Grid-No.2 Voltage	150	150	150	volts
Grid-No.1 Voltage	0	-22.5	-22.5	volts
Amplification Factor	-	-	4.4	
Plate Resistance (Approx.)	-	15000	-	ohms
Transconductance	-	7100	-	μmhos
Plate Current	390 ^d	70	-	ma
Grid-No.2 Current	32 ^d	2.1	-	ma
Grid-No.1 Voltage (Approx.) for plate ma. = 0.1	-	-42	-	volts

Mechanical:

Operating Position	Any
Type of Cathode	Coated Unipotential
Maximum Overall Length	3.410"
Maximum Seated Length	3.030"
Length, Base Seat to Bulb Top (Excluding tip)	2.510" to 2.690"
Diameter	1.438" to 1.562"
Bulb	T12
Socket	Cinch Mfg. Co. No.149 19 00 033, Industrial Electronic Hardware Co. No. S0-0968-SL1, or equivalent
Base	Large-Button Novar 9-Pin (JEDEC No.E9-76)

← Indicates a change.



6GT5

Basing Designation for BOTTOM VIEW. 9NZ

Pin 1-Grid No.2
Pin 2-Grid No.1
Pin 3-Cathode,
Grid No.3
Pin 4-Heater

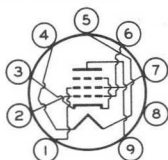

Pin 5-Heater
Pin 6-Grid No.1
Pin 7-Grid No.2
Pin 8-Do Not Use
Pin 9-Plate

HORIZONTAL-DEFLECTION AMPLIFIER

Maximum Ratings, Design-Maximum Values:

For operation in a 525-line, 30-frame system^e

DC PLATE-SUPPLY VOLTAGE	770 max.	volts
PEAK POSITIVE-PULSE PLATE VOLTAGE ^f	6500 max.	volts
PEAK NEGATIVE-PULSE PLATE VOLTAGE	1500 max.	volts
DC GRID-No.2 (SCREEN-GRID) VOLTAGE.	220 max.	volts
DC GRID-No.1 (CONTROL-GRID) VOLTAGE	-55 max.	volts
PEAK NEGATIVE-PULSE GRID-No.1 VOLTAGE	330 max.	volts
CATHODE CURRENT:		
Peak.	550 max.	ma
Average	175 max.	ma
GRID-No.2 INPUT	3.5 max.	watts
PLATE DISSIPATION ^g	17.5 max.	watts
BULB TEMPERATURE (At hottest point on bulb surface).	240 max.	°C

Maximum Circuit Values:

Grid-No.1-Circuit Resistance:

For grid-resistor-bias operation. 1 max. megohm

^a The dc component must not exceed 100 volts.

^b without external shield.

^c with grid No.2 connected to plate.

^d This value can be measured by a method involving a recurrent wave form such that the maximum ratings of the tube will not be exceeded.

^e As described in "Standards of Good Engineering Practice Concerning Television Broadcast Stations", Federal Communications Commission.

^f This rating is applicable where the duration of the voltage pulse does not exceed 15 per cent of one horizontal scanning cycle. In a 525-line, 30-frame system, 15 per cent of one horizontal scanning cycle is 10 microseconds.

^g An adequate bias resistor or other means is required to protect the tube in the absence of excitation.



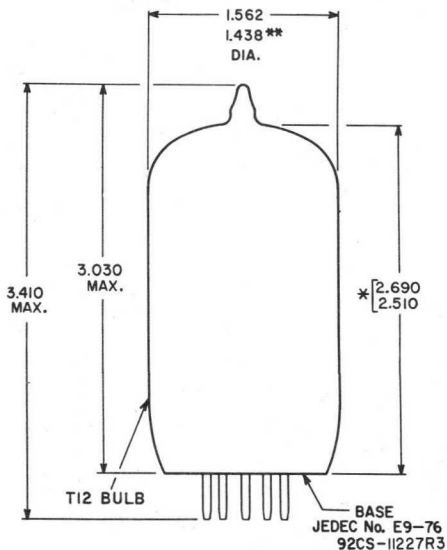

ALL DIMENSIONS IN INCHES

- ** APPLIES IN ZONE STARTING 0.375" FROM BASE SEAT.
- * MEASURED FROM BASE SEAT TO BULB-TOP LINE AS DETERMINED BY A RING GAUGE OF 0.600" INSIDE DIAMETER.



6GT5

AVERAGE CHARACTERISTICS

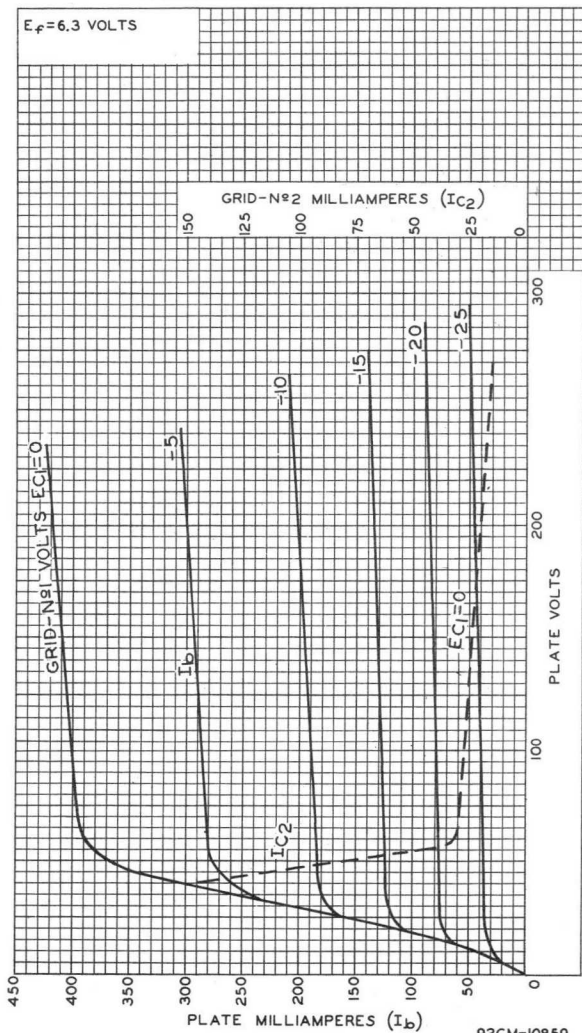

Beam Power Tube

NOVAR TYPE

For Horizontal-Deflection-Amplifier
Service in Black-and-White TV Receivers

Electrical:

Heater Characteristics and Ratings:

Voltage (AC or DC)	6.3 ± 0.6	volts
Current at heater volts = 6.3	1.200	amp
Peak heater-cathode voltage:		
Heater negative with respect to cathode.	200 max.	volts
Heater positive with respect to cathode.	200 ^a max.	volts

Direct Interelectrode Capacitances (Approx):^b

Grid No.1 to Plate	0.26	pf
Input: G ₁ to (K+G ₃ ,G ₂ ,H).	15.0	pf
Output: P to (K+G ₃ ,G ₂ ,H).	6.5	pf

Mechanical:

Operating Position	Any
Type of Cathode	Coated Unipotential
Maximum Overall Length	2.880"
Seated Length	2.250" to 2.500"
Diameter	1.438" to 1.562"
Dimensional Outline	See <i>General Section</i>
Bulb	T12
Base	Large-Button Novar 9-Pin with Exhaust Tip (JEDEC No. E9-88)
Basing Designation for BOTTOM VIEW	9NZ

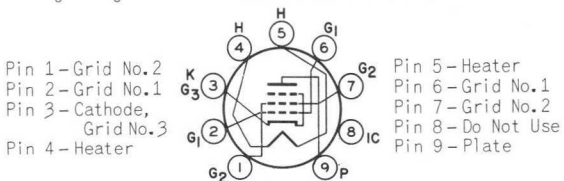

Characteristics, Class A₁ Amplifier:

	Triode Connection ^c	Pentode Connection	
Plate Voltage.	150	60	250 volts
Grid-No.2 Voltage.	150	150	150 volts
Grid-No.1 Voltage.	-22.5	0	-22.5 volts
Amplification Factor	4.4	-	-
Plate Resistance (Approx.)	-	-	15000 ohms
Transconductance	-	-	7100 μmhos
Plate Current.	-	390 ^d	70 ma
Grid-No.2 Current.	-	32 ^d	2.1 ma
Grid-No.1 Voltage (Approx.) for plate ma = 0.1	-	-	-42 volts



6GT5A

HORIZONTAL-DEFLECTION AMPLIFIER

Maximum Ratings, Design-Maximum Values:

For operation in a 525-line, 30-frame system^e

DC Plate-Supply Voltage.	770 max.	volts
Peak Positive-Pulse Plate Voltage ^f	6500 max.	volts
Peak Negative-Pulse Plate Voltage.	1500 max.	volts
DC Grid-No.2 (Screen-Grid) Voltage	220 max.	volts
DC Grid-No.1 (Control-Grid) Voltage.	-55 max.	volts
Peak Negative-Pulse Grid-No.1 Voltage.	330 max.	volts
Cathode Current:		
Peak	550 max.	ma
Average.	175 max.	ma
Grid-No.2 Input.	3.5 max.	watts
Plate Dissipation ^g	17.5 max.	watts
Bulb Temperature (At hottest point on bulb surface)	240 max.	°C

Maximum Circuit Values:

Grid-No.1-Circuit Resistance:

For grid-resistor-bias operation 1 max. megohm

^a The dc component must not exceed 100 volts.

^b Without external shield.

^c With grid No.2 connected to plate.

^d This value can be measured by a method involving a recurrent wave form such that the maximum ratings of the tube will not be exceeded.

^e As described in "Standards of Good Engineering Practice Concerning Television Broadcast Stations", Federal Communications Commission.

^f This rating is applicable where the duration of the voltage pulse does not exceed 15 per cent of one horizontal scanning cycle. In a 525-line, 30-frame system, 15 per cent of one horizontal scanning cycle is 10 microseconds.

^g An adequate bias resistor or other means is required to protect the tube in the absence of excitation.



AVERAGE CHARACTERISTICS

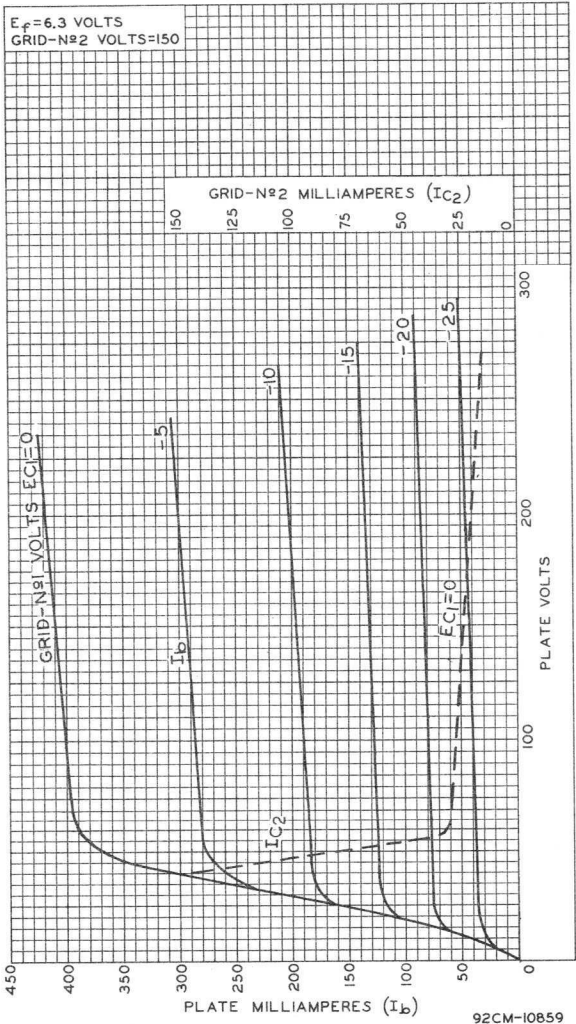



Beam Hexode

ELECTRICAL

Heater Characteristics and Ratings

Voltage (AC or DC)	6.3 ± 0.6	V
Current at 6.3 V	0.220	A
Maximum heater-cathode voltage		
Heater negative with respect to cathode		
Peak	200	V
Heater positive with respect to cathode		
Peak	200	V
DC component	100	V

Direct Interelectrode Capacitances (Approx.)

Without external shield		
Grid No.1 to plate	0.018	pF
Input: G1 to (K + G4 + G2, G3, H)	7.0	pF
Output: P to (K + G4 + G2, G3, H)	3.2	pF

MECHANICAL

Operating Position	Any
Type of Cathode	Coated Unipotential
Maximum Overall Length	2-1/8 in
Maximum Seated Length	1-7/8 in
Length, Base Seat to Bulb Top (Excluding tip)	1-1/2 ± 3/32 in
Diameter	0.650 to 0.750 in
Dimensional Outline (JEDEC No.5-2)	See <i>General Section</i>
Envelope	JEDEC T5-1/2
Base	Small-Button Miniature 7-Pin (JEDEC No.E7-1)

TERMINAL DIAGRAM (Bottom View)

- Pin 1—Grid No.1
- Pin 2—Cathode, Grid No.2, Grid No.4
- Pin 3—Heater
- Pin 4—Heater
- Pin 5—Plate
- Pin 6—Grid No.3
- Pin 7—Same as Pin 2

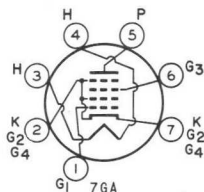

CHARACTERISTICS

Plate Voltage	135	275	V
Grid-No.3 Voltage	135	135	V
Grid-No.1 Voltage	-0.4	-0.4	V
Plate Resistance (Approx.)	0.67	0.165	MΩ
Transconductance	15000	15500	μmhos
Plate Current	9	10	mA
Grid-No.3 Current	0.25	0.17	mA
Grid-No.1 Voltage (Approx.)	-6.2	-6.5	V
For transconductance = 100 μmhos			
Noise Figure	5.9	5.7	dB
At 200 Mc/s			



6GU5

DESIGN-MAXIMUM RATINGS

Plate Voltage.	300	V
Grid-No.3 (Screen-Grid) Voltage.	150	V
Grid-No.1 (Control-Grid) Voltage		
Negative-bias value.	50	V
Positive-bias value.	0	V
Cathode Current.	20	mA
Grid-No.3 Input.	0.15	W
Plate Dissipation.	3	W

MAXIMUM CIRCUIT VALUES

Grid-No.1-Circuit Resistance		
For fixed-bias operation	0.5	MΩ



Medium-Mu Twin Triode

9-PIN MINIATURE TYPE

For Use in the Matrixing Circuits of Color TV Receivers.
Also Useful in Phase-Inverter and Multivibrator Circuits, and as a General-Purpose Amplifier Tube.

GENERAL DATA

Electrical:

Heater Characteristics and Ratings:

Voltage (AC or DC) . . .	6.3 ^a	6.3 ± 0.6	volts
Current	0.600 ± 0.040	0.600 ^b	ma
Warm-up time (Average).	11	-	sec
Peak heater-cathode voltage			

(Each unit):

Heater negative with respect to cathode.	200 max.	volts
Heater positive with respect to cathode.	200 ^c max.	volts

Direct Interelectrode Capacitances (Approx.):^d

	Unit No. 1	Unit No. 2	
Grid to plate	3.0	3.0	pf
Grid to cathode and heater.	3.4	3.6	pf
Plate to cathode and heater	0.44	0.34	pf
Plate of unit No.1 to plate of unit No.2.	1.0	1.0	pf

Characteristics, Class A₁ Amplifier (Each unit):

Plate Voltage	250	volts
Grid Voltage.	-10.5	volts
Amplification Factor.	17	
Plate Resistance (Approx.).	5500	ohms
Transconductance.	3100	μmhos
Plate Current	11.5	ma
Plate Current for grid volts = -14.	4	ma
Grid Voltage (Approx.) for plate μa = 50.	-23	volts

Mechanical:

Operating Position.	Any
Type of Cathodes.	Coated Unipotential
Maximum Overall Length.	2-5/8"
Maximum Seated Length.	2-3/8"
Length, Base Seat to Bulb Top (Excluding tip)	2" ± 3/32"
Diameter.	0.750" to 0.875"
Dimensional Outline	See <i>General Section</i>
Bulb.	T6-1/2
Base.	Small-Button Noval 9-Pin (JEDEC No.E9-1)



6GU7

Basing Designation for BOTTOM VIEW. 9LP

Pin 1 -Plate of
Triode No.2
Pin 2 -Grid of
Triode No.2
Pin 3 -Cathode of
Triode No.2
Pin 4 -Heater
Pin 5 -Heater

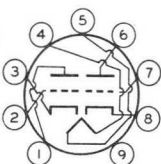

Pin 6 -Plate of
Triode No.1
Pin 7 -Grid of
Triode No.1
Pin 8 -Cathode of
Triode No.1
Pin 9 -No Internal
Connection

AMPLIFIER — Class A₁

Values are for Each Unit

Maximum Ratings, Design-Maximum Values:

PLATE VOLTAGE. 330 max. volts
GRID VOLTAGE:
Positive-bias value. 0 max. volts
PLATE DISSIPATION. 3 max. watts

Maximum Circuit Values:

Grid-Circuit Resistance:
For fixed-bias operation 1 max. megohm

- a At heater amperes = 0.600.
- b At heater volts = 6.3.
- c The dc component must not exceed 100 volts.
- d without external shield.



AVERAGE PLATE CHARACTERISTICS

Each Unit

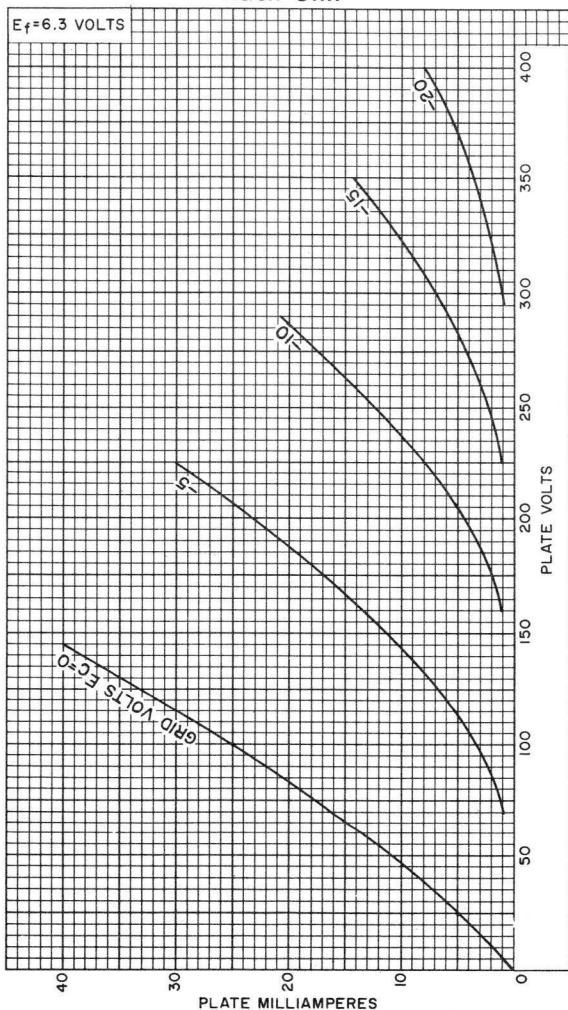

92CM-11966



1000



Beam Power Tube

DUODECAR TYPE

Electrical:

Heater Characteristics and Ratings:

Voltage (AC or DC)	6.3 ± 0.6	volts
Current at heater volts = 6.3.	1.200	amp
Peak heater-cathode voltage:		
Heater negative with respect to cathode.	200 max.	volts
Heater positive with respect to cathode.	200 ^a max.	volts

Direct Interelectrode Capacitances (Approx):^b

G1 to P.	0.6	pf
Input: G1 to (K+G3,G2,H).	16	pf
Output: P to (K+G3,G2,H)	7.0	pf

Mechanical:

Operating Position	Any
Type of Cathode.	Coated Unipotential
Maximum Overall Length	3.625"
Seated Length.	2.000" to 2.250"
Diameter	1.437" to 1.563"
Dimensional Outline.	See <i>General Section</i>
Bulb	T12
Cap.	Skirted Miniature (JEDEC No.C1-3)
Base	Large-Button Duodecar 12-Pin (JEDEC No.E12-74)
Basing Designation for BOTTOM VIEW	12DR

- Pin 1-Heater
- Pin 2-No Internal Connection
- Pin 3-Grid No.2
- Pin 4-Cathode, Grid No.3
- Pin 5-Grid No.1
- Pin 6-Same as Pin 2
- Pin 7-Grid No.2
- Pin 8-Same as Pin 2
- Pin 9-Grid No.1
- Pin 10-Same as Pin 4
- Pin 11-Grid No.2
- Pin 12-Heater
- Cap-Plate

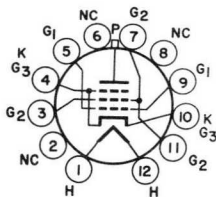

Characteristics, Class A₁ Amplifier:

	Triode Connec- tion ^c				
Plate Voltage.	5000	60	250	150	volts
Grid-No.2 Voltage.	150	150	150	150	volts
Grid-No.1 Voltage.	-	0	-22.5	-22.5	volts
Amplification Factor	-	-	-	4.4	
Plate Resistance (Approx.)	-	-	18000	-	ohms
Transconductance	-	-	7300	-	μmhos
Plate Current.	-	345 ^d	65	-	ma
Grid-No.2 Current.	-	27 ^d	1.8	-	ma
Grid-No.1 Voltage (Approx.) for plate ma. = 1	-100	-	-42	-	volts



6GV5

HORIZONTAL-DEFLECTION AMPLIFIER

Maximum Ratings, Design-Maximum Values:

For operation in a 525-line, 30-frame system^e

DC Plate-Supply Voltage.	770 max.	volts
Peak Positive-Pulse Plate Voltage ^f	6500 max.	volts
Peak Negative-Pulse Plate Voltage.	1500 max.	volts
DC Grid-No.2 (Screen-Grid) Voltage	220 max.	volts
DC Grid-No.1 (Control-Grid) Voltage.	-55 max.	volts
Peak Negative-Pulse Grid-No.1 Voltage.	330 max.	volts
Cathode Current:		
Peak	550 max.	ma
Average.	175 max.	ma
Grid-No.2 Input.	3.5 max.	watts
Plate Dissipation ^g	17.5 max.	watts
Bulb Temperature (At hottest point on bulb surface.	220 max.	°C

Maximum Circuit Values:

Grid-No.1-Circuit Resistance:

For grid-resistor-bias operation 1 max. megohm

- ^a The dc component must not exceed 100 volts.
- ^b Without external shield.
- ^c With grid No.2 connected to plate.
- ^d This value can be measured by a method involving a recurrent wave form such that the maximum ratings of the tube will not be exceeded.
- ^e As described in "Standards of Good Engineering Practice Concerning Television Broadcast Stations", Federal Communications Commission.
- ^f This rating is applicable where the duration of the voltage pulse does not exceed 15 per cent of one horizontal scanning cycle. In a 525-line, 30-frame system, 15 per cent of one horizontal scanning cycle is 10 microseconds.
- ^g An adequate bias resistor or other means is required to protect the tube in the absence of excitation.



Beam Power Tube

GENERAL DATA

Electrical:

Heater, for Unipotential Cathode:

Voltage (AC or DC)	6.3 ± 10%	volts
Current at 6.3 volts	1.2	amp

Mu-Factor, Grid No.2 to Grid No.1

for plate volts = 150, grid-No.2 volts = 150, grid-No.1 volts = -22.5	4.4	
---	-----	--

Direct Interelectrode Capacitances

(Approx.): ^a		
Grid No.1 to plate	0.5	μmf
Grid No.1 to cathode & grid No.3, grid No.2, and heater	17	μmf
Plate to cathode & grid No.3, grid No.2, and heater	7	μmf

Characteristics, Class A₁ Amplifier:

Plate Voltage	60	250	volts
Grid-No.2 Voltage	150	150	volts
Grid-No.1 Voltage	0	-22.5	volts
Plate Resistance (Approx.)	-	15000	ohms
Transconductance	-	7100	μmhos
Plate Current	390 ^b	70	ma
Grid-No.2 Current	32 ^b	2.1	ma
Grid-No.1 Voltage (Approx.) for plate ma. = 1	-	-42	volts

Mechanical:

Operating Position	Any
Maximum Overall Length	4-1/4"
Seated Length	3-1/2" ± 3/16"
Diameter	1.438" to 1.562"
Bulb	T12
Cap	Skirted Miniature (JEDEC No.C1-3)
Base	Short Medium-Shell Octal 6-Pin with External Barriers, Style B, Arrangement 2 (JEDEC No.B6-122)

Basing Designation for BOTTOM VIEW 6AM

- Pin 2 - Heater
- Pin 3 - No Connection
- Pin 4 - Grid No.2
- Pin 5 - Grid No.1

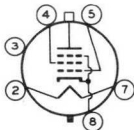

- Pin 7 - Heater
- Pin 8 - Cathode,
Grid No.3
Cap - Plate



6GW6

HORIZONTAL-DEFLECTION AMPLIFIER

Maximum Ratings, Design-Maximum Values:

For operation in a 525-line, 30-frame system^c

DC PLATE-SUPPLY VOLTAGE	770	max.	volts
PEAK POSITIVE-PULSE PLATE VOLTAGE ^d	6500	max.	volts
PEAK NEGATIVE-PULSE PLATE VOLTAGE	1500	max.	volts
DC GRID-No.2 (SCREEN-GRID) VOLTAGE.	220	max.	volts
DC GRID-No.1 (CONTROL-GRID) VOLTAGE	-55	max.	volts
PEAK NEGATIVE-PULSE GRID-No.1 VOLTAGE	330	max.	volts
CATHODE CURRENT:			
Peak	550	max.	ma
Average	175	max.	ma
GRID-No.2 INPUT	3.5	max.	watts
PLATE DISSIPATION ^e	17.5	max.	watts
PEAK HEATER-CATHODE VOLTAGE:			
Heater negative with respect to cathode	200	max.	volts
Heater positive with respect to cathode	200 ^f	max.	volts
BULB TEMPERATURE (At hottest point on bulb surface).			
	240	max.	°C

Maximum Circuit Values:

Grid-No.1-Circuit Resistance:

For grid resistor-bias operation.	1	max.	megohm
---	---	------	--------

^a Without external shield.

^b This value can be measured by a method involving a recurrent wave form such that the maximum ratings of the tube will not be exceeded.

^c As described in "Standards of Good Engineering Practice Concerning Television Broadcast Stations," Federal Communications Commission.

^d This rating is applicable where the duration of the voltage pulse does not exceed 15 per cent of one horizontal scanning cycle. In a 525-line, 30-frame system, 15 per cent of one horizontal scanning cycle is 10 microseconds.

^e An adequate bias resistor or other means is required to protect the tube in the absence of excitation.

^f The dc component must not exceed 100 volts.



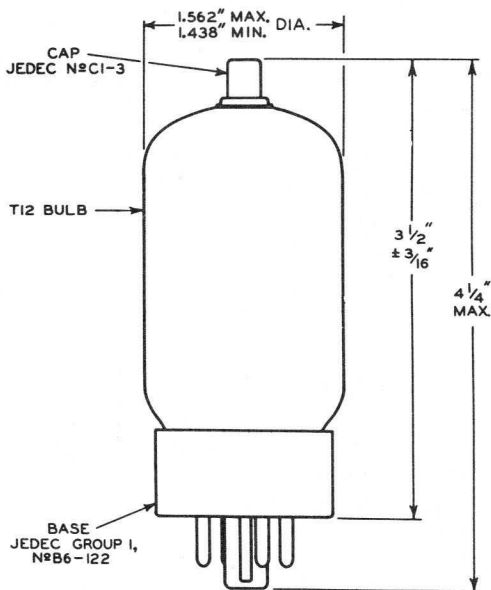

92CS-10820RI



AVERAGE CHARACTERISTICS

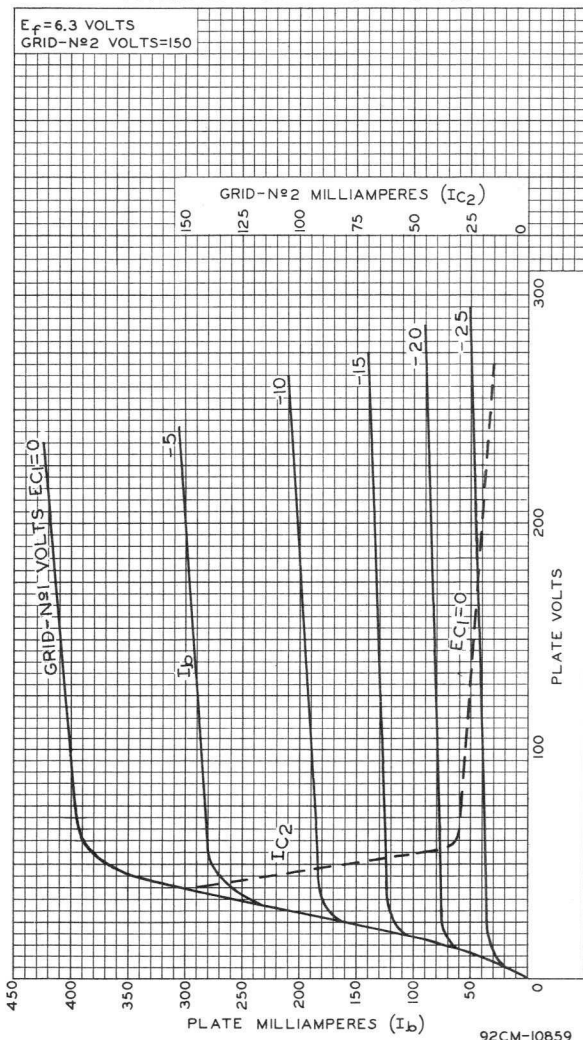

92CM-10859



6GW8/ECL86

High-Mu Triode- Sharp-Cutoff Pentode

Electrical:

Heater Characteristics and Ratings:

Voltage (AC or DC)	6.3	volts
Current at heater volts = 6.3	0.660	amp
Peak heater-cathode voltage	100	volts

Direct Interelectrode Capacitances:

Triode Unit:

Grid to plate	1.4	pf
Input: G_T to (K_T , H)	2.3	pf
Output: P_T to (K_T , H)	2.5	pf
Grid to heater	0.006 max.	pf

Pentode Unit:

Grid No.1 to plate	0.4 max.	pf
Input: G_{1P} to ($K_P+G_{3P}+IS, G_{2P}, H$)	10.0	pf
Grid No.1 to heater	0.24 max.	pf
Triode plate to pentode grid No.1	0.2 max.	pf
Triode grid to pentode plate	0.006 max.	pf
Triode grid to pentode grid No.1	0.02 max.	pf
Triode plate to pentode plate	0.15 max.	pf

Mechanical:

Operating Position	Any
Maximum Overall Length	3-1/16"
Maximum Seated Length	2-13/16"
Length, Base Seat to Bulb Top (Excluding Tip)	2-7/16" \pm 3/32"
Diameter	0.750" to 0.875"
Dimensional Outline (JEDEC No.6-4)	See <i>General Section</i>
Bulb	T6-1/2
Base	Small-Button Noval 9-Pin (JEDEC No.E9-1)
Basing Designation for BOTTOM VIEW	9LZ

- Pin 1 - Triode Grid
- Pin 2 - Triode Cathode
- Pin 3 - Pentode Grid No.2
- Pin 4 - Heater
- Pin 5 - Heater
- Pin 6 - Pentode Plate
- Pin 7 - Pentode Cathode, Grid No.3,
Internal Shield
- Pin 8 - Pentode Grid No.1
- Pin 9 - Triode Plate

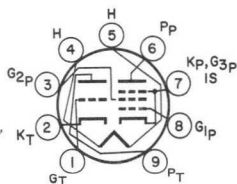

6GW8/ECL86

CLASS A₁ AMPLIFIER

Characteristics:

	Triode Unit	Pentode Unit	
Plate Voltage	250	250	volts
Grid No.2 (Screen-Grid) Voltage . . .	-	250	volts
Grid No.1 (Control-Grid) Voltage . . .	-1.9	-7	volts
Amplification Factor	100	21 ^a	
Plate Resistance (Approx.)	-	48000	ohms
Transconductance	1600	10000	μmhos
Plate Current	1.2	36	ma
Grid-No.2 Current	-	6	ma

Maximum Ratings, Design-Center Values:

Plate Supply Voltage	550	550	volts
Plate Voltage	300	300	volts
Grid-No.2 Supply Voltage	-	550	volts
Grid-No.2 Voltage	-	300	volts
Average Cathode Current	4	55	ma
Grid-No.2 Input	-	1.8	watts
Plate Dissipation	0.5	9	watts
Grid-No.1 Voltage at grid No.1 μa = 0.3	-1.3	-1.3	volts

Maximum Circuit Values:

Grid-No.1 Circuit Resistance: For fixed-bias operation	1	0.5	megohm
---	---	-----	--------

^a Grid No.1 to Grid No.2



Sharp-Cutoff Pentode

With Two Independent Control Grids

7-PIN MINIATURE TYPE

For FM Sound-Detector Service

GENERAL DATA

Electrical:

Heater, for Unipotential Cathode:

Voltage (AC or DC)	6.3	volts
Current	0.45 ± 6%	amp
Warm-up time (Average)	11	sec

Direct Interelectrode Capacitances

(Approx.):^a

Grid No.1 to plate	0.022	μf
Grid No.1 to cathode & internal shield, grid No.3, grid No.2, and heater	8	μf
Grid No.3 to plate	1.6	μf
Grid No.1 to grid No.3	0.11	μf
Grid No.3 to cathode & internal shield, plate, grid No.2, grid No.1, and heater	7.5	μf

Characteristics, Class A₁ Amplifier:

Plate Supply Voltage	150	volts
Grid-No.3 Supply Voltage	0	volts
Grid-No.2 Supply Voltage	100	volts
Grid-No.1 Supply Voltage	0	volts
Cathode Resistor	180	ohms
Plate Resistance (Approx.)	0.14	megohm
Transconductance, Grid No.1 to Plate	3700	μmhos
Transconductance, Grid No.3 to Plate	750	μmhos
Plate Current	3.7	ma
Grid-No.2 Current	3	ma
Grid-No.1 Supply Voltage (Approx.) for plate $\mu\alpha = 20$	-4.5	volts
Grid-No.3 Supply Voltage (Approx.) for plate $\mu\alpha = 20$	-7	volts

Mechanical:

Operating Position	Any
Maximum Overall Length	2-1/8"
Maximum Seated Length	1-7/8"
Length, Base Seat to Bulb Top (Excluding tip)	1-1/2" ± 3/32"
Diameter	0.650" to 0.750"
Dimensional Outline	See <i>General Section</i>
Bulb	T5-1/2
Base	Small-Button Miniature 7-Pin (JEDEC No.E7-1)



6GX6

Basing Designation for BOTTOM VIEW. 7EN

Pin 1—Grid No.1
 Pin 2—Cathode,
 Internal
 Shield
 Pin 3—Heater

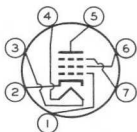

Pin 4—Heater
 Pin 5—Plate
 Pin 6—Grid No.2
 Pin 7—Grid No.3

FM SOUND-DETECTOR SERVICE

Maximum Ratings, Design-Maximum Values:

PLATE VOLTAGE	300	max.	volts
GRID-No.3 (CONTROL-GRID) VOLTAGE:			
Negative value (DC and Peak AC)	100	max.	volts
Positive value (DC and Peak AC)	25	max.	volts
GRID-No.2 (SCREEN-GRID) SUPPLY VOLTAGE.	300	max.	volts
GRID-No.2 VOLTAGESee <i>Grid-No.2 Input Rating Chart</i> at front of Receiving Tube Section		
GRID-No.1 (CONTROL-GRID) VOLTAGE:			
Negative-bias value	50	max.	volts
Positive-bias value	0	max.	volts
GRID-No.2 INPUT:			
For grid-No.2 voltages up to 150 volts.	1	max.	watt
For grid-No.2 voltages between 150 and 300 voltsSee <i>Grid-No.2 Input Rating Chart</i> at front of Receiving Tube Section		
GRID-No.3 INPUT	0.1	max.	watt
PLATE DISSIPATION	1.7	max.	watts
PEAK HEATER-CATHODE VOLTAGE:			
Heater negative with respect to cathode.	200	max.	volts
Heater positive with respect to cathode.	200 ^b	max.	volts

Maximum Circuit Values:

Grid-No.3—Circuit Resistance.	0.68	max.	megohm
Grid-No.1—Circuit Resistance:			
For fixed-bias operation.	0.22	max.	megohm
For cathode-bias operation.	0.47	max.	megohm

^a Without external shield.

^b The dc component must not exceed 100 volts.



AVERAGE CHARACTERISTICS

$E_f = 6.3$ VOLTS
 GRID-No. 3 VOLTS=0
 GRID-No. 2 VOLTS=100

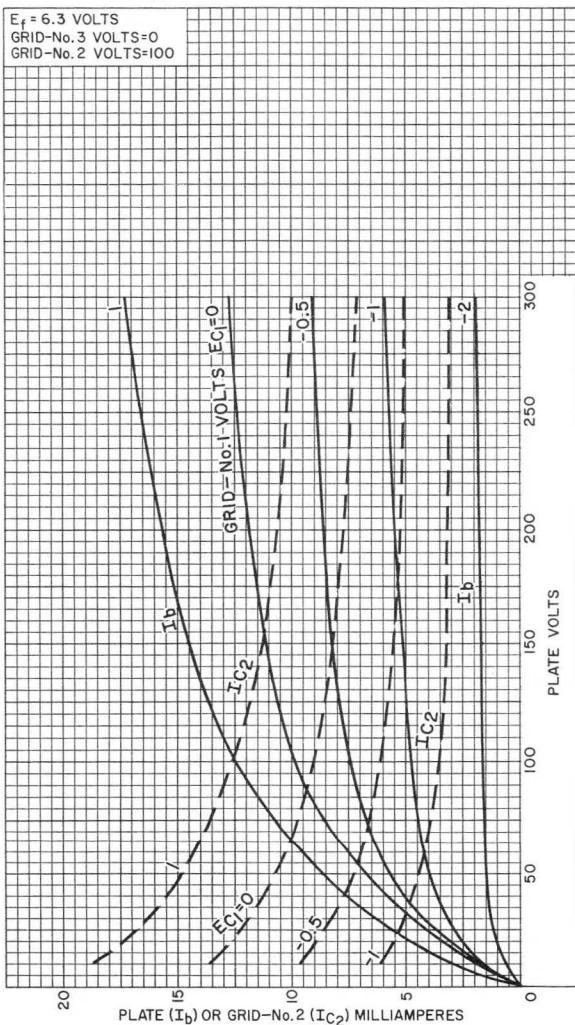

92CM-11002



6GX6

AVERAGE CHARACTERISTICS

$E_f = 6.3$ VOLTS
PLATE VOLTS = 150
GRID-NO. 2 VOLTS = 100

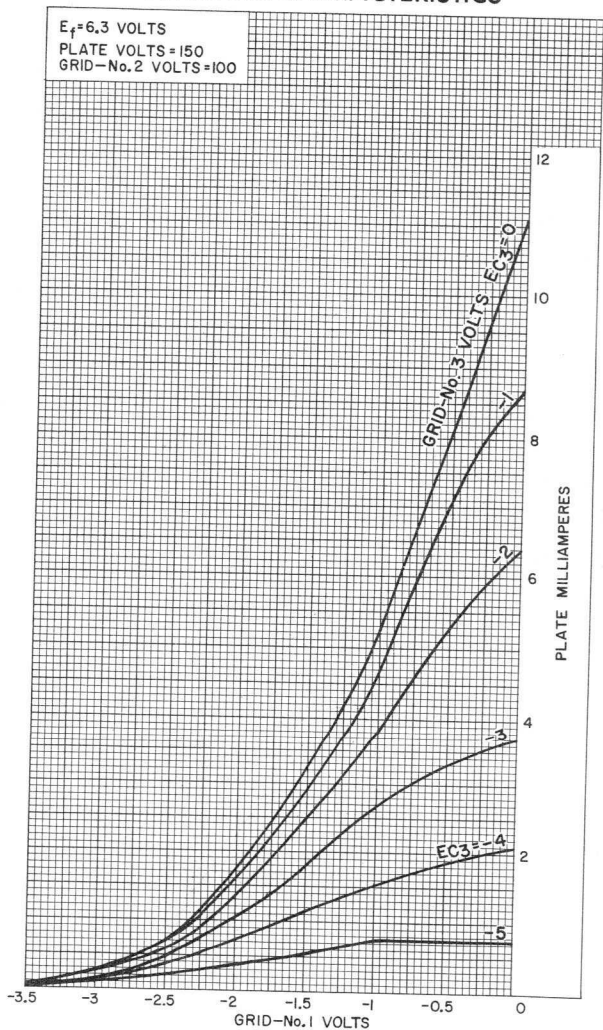

92CM-11005

RADIO CORPORATION OF AMERICA
Electron Tube Division

Harrison, N. J.



AVERAGE CHARACTERISTICS

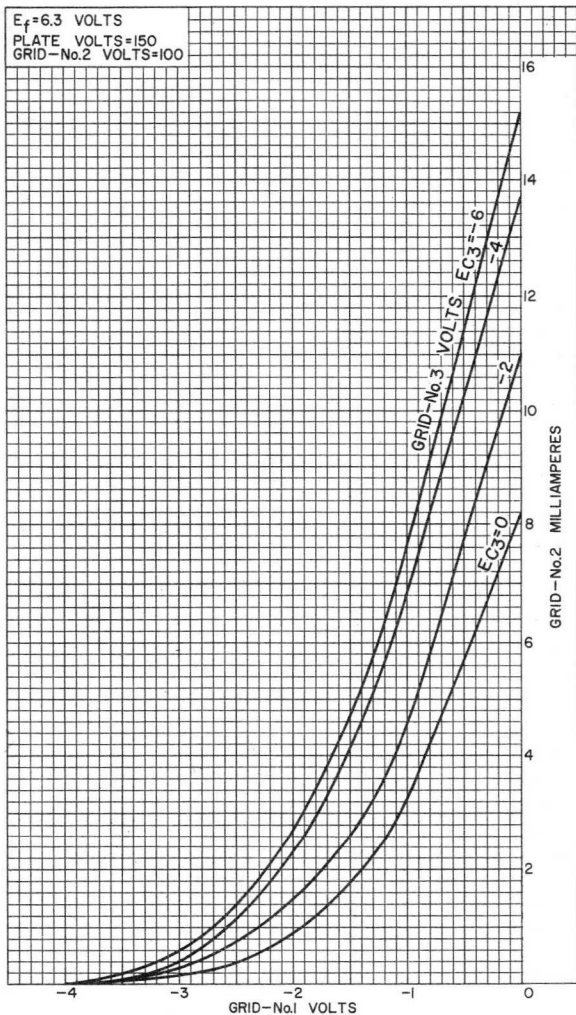

92CM-11007



6GX6

AVERAGE CHARACTERISTICS

$E_f = 6.3$ VOLTS
GRID-No.2 VOLTS = 100
GRID-No.1 VOLTS = 0

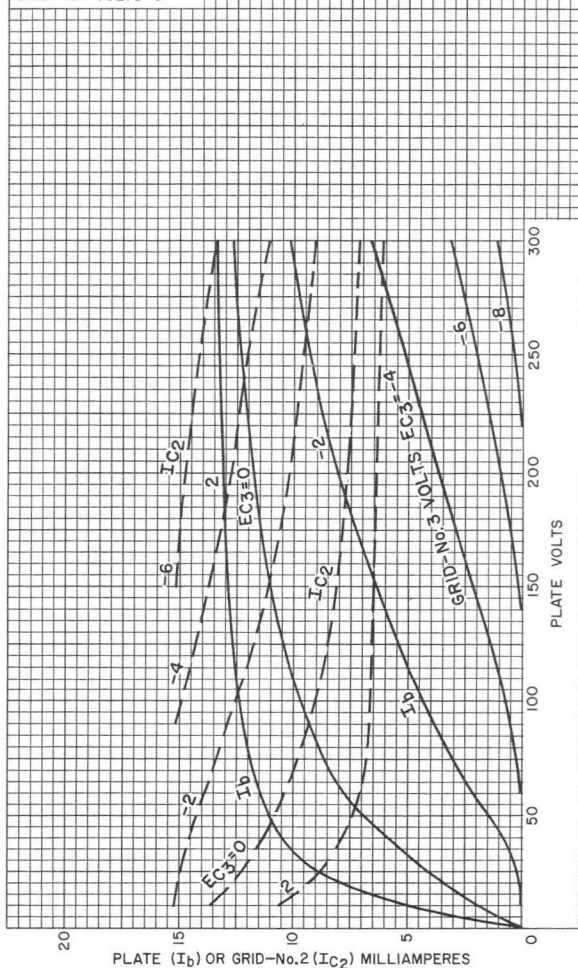

92CM-11003

RADIO CORPORATION OF AMERICA
Electron Tube Division

Harrison, N. J.



AVERAGE CHARACTERISTICS

$E_f = 6.3$ VOLTS
 PLATE VOLTS=150
 GRID-No.2 VOLTS=100

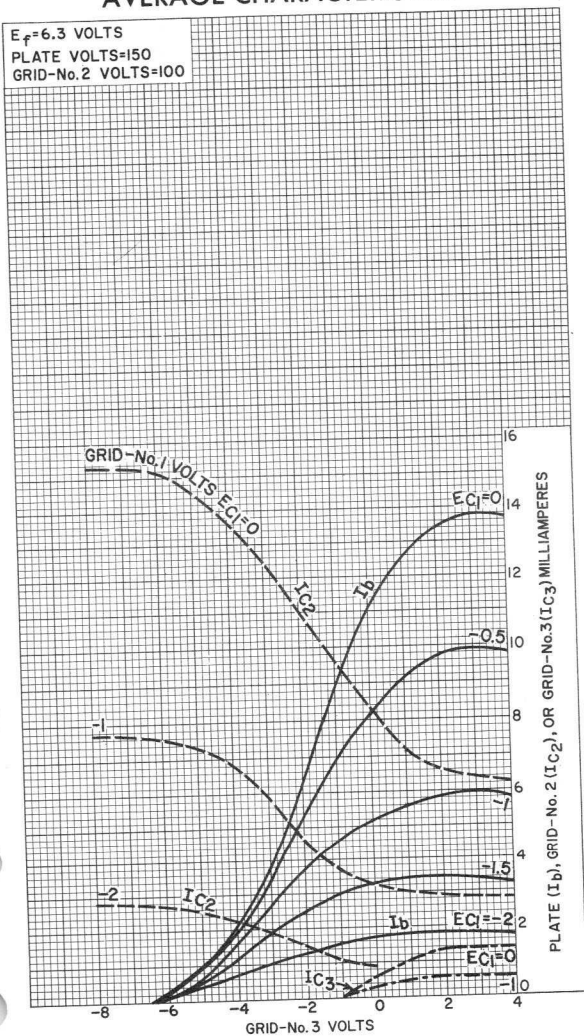

92CM-11006



6GX6

AVERAGE GRID-No.1 OPERATION CHARACTERISTIC

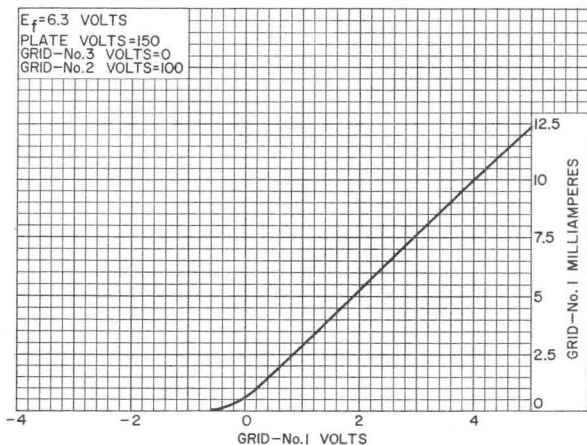

92CS-11004



Sharp-Cutoff Pentode

With Two Independent Control Grids

7-PIN MINIATURE TYPE

With Heater Having Controlled Warm-Up Time

GENERAL DATA

Electrical:

Heater, for Unipotential Cathode:

Voltage (AC or DC)	6.3	volts
Current	0.45 ± 6%	amp
Warm-up time (Average)	11	sec

Direct Interelectrode Capacitances
(Approx.):^a

Grid No.1 to plate	0.026	μf
Grid No.1 to cathode & internal shield, grid No.3, grid No.2, and heater	8	μf
Grid No.3 to plate	1.6	μf
Grid No.1 to grid No.3	0.12	μf
Grid No.3 to cathode & internal shield, plate, grid No.2, grid No.1, and heater	6.5	μf

Characteristics, Class A₁ Amplifier:

Plate Supply Voltage	150	volts
Grid-No.3 Supply Voltage	0	volts
Grid-No.2 Supply Voltage	100	volts
Grid-No.1 Supply Voltage	0	volts
Cathode Resistor	180	ohms
Plate Resistance (Approx.)	0.14	megohm
Transconductance, Grid No.1 to Plate	3700	μmhos
Transconductance, Grid No.3 to Plate	750	μmhos
Plate Current	3.7	ma
Grid-No.2 Current	3	ma
Grid-No.1 Supply Voltage (Approx.) for plate $\mu a = 20$	-4.5	volts
Grid-No.3 Supply Voltage (Approx.) for plate $\mu a = 20$	-7	volts

Mechanical:

Operating Position	Any
Maximum Overall Length	2-1/8"
Maximum Seated Length	1-7/8"
Length, Base Seat to Bulb Top (Excluding tip)	1-1/2" ± 3/32"
Diameter	0.650" to 0.750"
Dimensional Outline	See <i>General Section</i>
Bulb	T5-1/2
Base	Small-Button Miniature 7-Pin (JEDEC No.E7-1)



6GY6

Basing Designation for BOTTOM VIEW. 7EN

Pin 1-Grid No.1
Pin 2-Cathode,
Internal
Shield
Pin 3-Heater

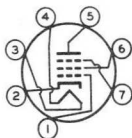

Pin 4-Heater
Pin 5-Plate
Pin 6-Grid No.2
Pin 7-Grid No.3

GATED AGC AMPLIFIER & NOISE INVERTER

For operation in a 525-line, 30-frame system^b

Maximum Ratings, Design-Maximum Values:

PLATE VOLTAGE.	300	max.	volts
PEAK POSITIVE-PULSE PLATE VOLTAGE ^c	600	max.	volts
GRID-No.3 (CONTROL-GRID) VOLTAGE:			
Negative-bias value.	100	max.	volts
Positive-bias value.	0	max.	volts
GRID-No.2 (SCREEN-GRID) SUPPLY VOLTAGE	300	max.	volts
GRID-No.2 VOLTAGE.	See <i>Grid-No.2 Input Rating Chart</i> at front of Receiving Tube Section		
GRID-No.1 (CONTROL-GRID) VOLTAGE:			
Negative-bias value.	50	max.	volts
Positive-bias value.	0	max.	volts
GRID-NO.2 INPUT:			
For grid-No.2 voltages up to 150 volts	1	max.	watt
For grid-No.2 voltages between 150 and 300 volts.	See <i>Grid-No.2 Input Rating Chart</i> at front of Receiving Tube Section		
PLATE DISSIPATION.	1.7	max.	watts
PEAK HEATER-CATHODE VOLTAGE:			
Heater negative with respect to cathode.	200	max.	volts
Heater positive with respect to cathode.	200 ^d	max.	volts

Maximum Circuit Values:

Grid-No.3-Circuit Resistance	0.68	max.	megohm
Grid-No.1-Circuit Resistance:			
For fixed-bias operation	0.22	max.	megohm
For cathode-bias operation	0.47	max.	megohm

^a Without external shield.

^b As described in "Standards of Good Engineering Practice Concerning Television Broadcast Stations," Federal Communications Commission.

^c This rating is applicable when the duration of the voltage pulse does not exceed 15 per cent of one horizontal scanning cycle. In a 525-line, 30-frame system, 15 per cent of one horizontal scanning cycle is 10 microseconds.

^d The dc component must not exceed 100 volts.



AVERAGE CHARACTERISTICS

$E_f = 6.3$ VOLTS
 GRID-No. 3 VOLTS=0
 GRID-No. 2 VOLTS=100

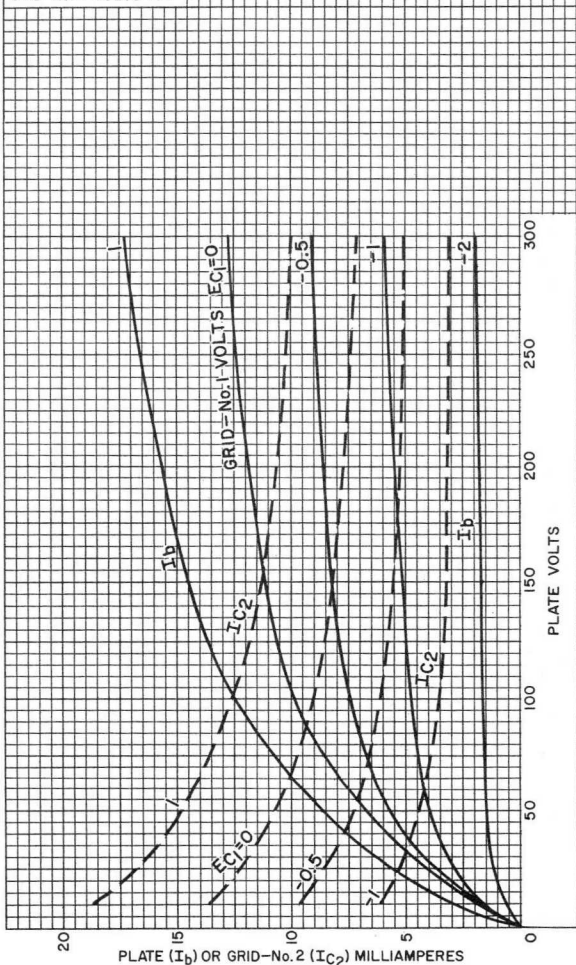

92CM-11002



6GY6

AVERAGE CHARACTERISTICS

$E_f = 6.3$ VOLTS
GRID-No.2 VOLTS = 100
GRID-No.1 VOLTS = 0

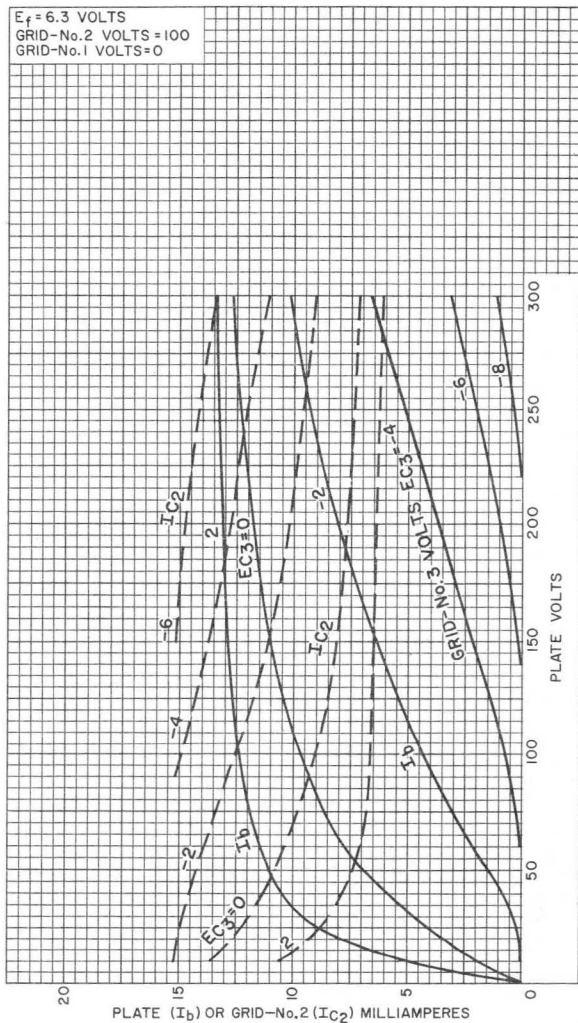

92CM-11003

RADIO CORPORATION OF AMERICA
Electron Tube Division

Harrison, N. J.



AVERAGE CHARACTERISTICS

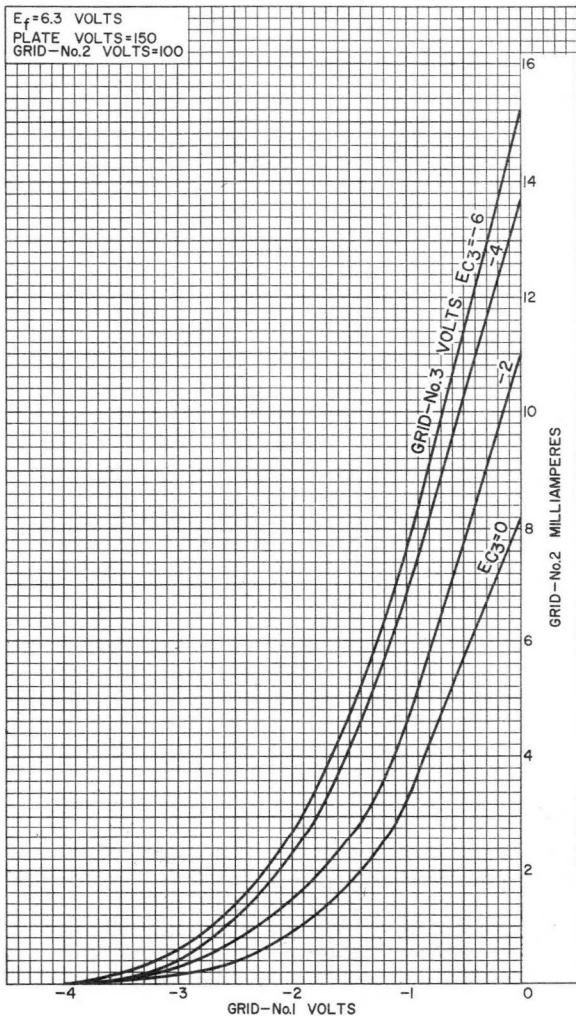

92CM-11007



6GY6

AVERAGE CHARACTERISTICS

$E_f = 6.3$ VOLTS
PLATE VOLTS = 150
GRID-NO. 2 VOLTS = 100

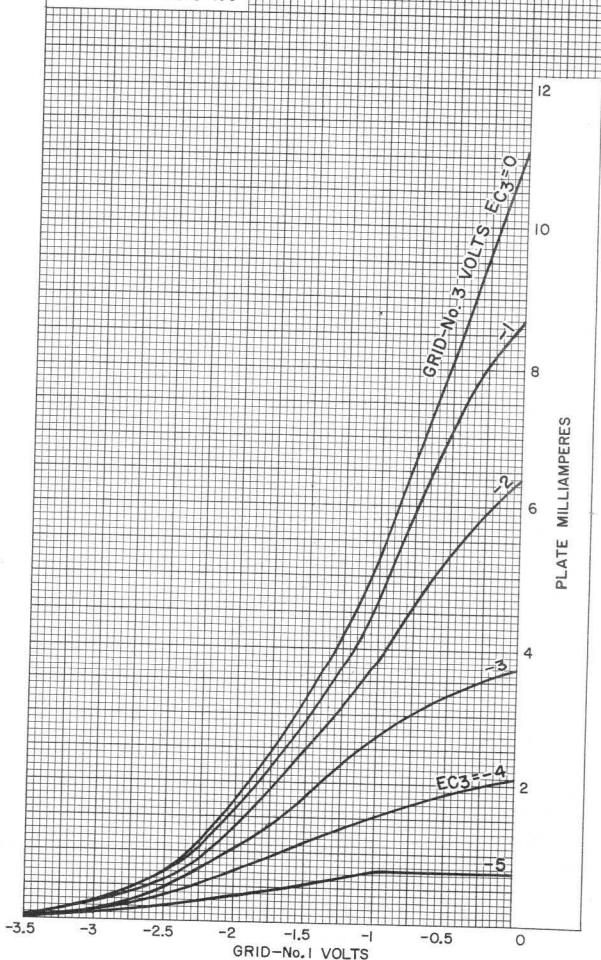

92CM-11005

RADIO CORPORATION OF AMERICA
Electron Tube Division

Harrison, N. J.





6H6
6H6-GT/G

6H6, 6H6-GT/G

TWIN DIODE

Heater		Coated Unipotential Cathodes	
Voltage	6.3	a-c or d-c volts	
Current	0.3	amp.	
		6H6	6H6-GT/G
Direct Interelectrode Cap. ^o			
Plate #1 to Cathode #1	3.0	3.0	μuf
Plate #2 to Cathode #2	3.4	4.0	μuf
Plate #1 to Plate #2	0.10 max.	0.10 max.	μuf
Maximum Overall Length	1-3/4"	3-5/16"	
Maximum Seated Height	1-3/16"	2-3/4"	
Maximum Diameter	1-5/16"	1-5/16"	
Bulb	Metal Shell MT-8	T-9	
Base	{ Small Wafer { Octal 7-Pin	{ Intermed. Shell { Octal 7-Pin	
Basing Designation	70	G-7Q	
Pin 1 { 6H6, Shell { 6H6-GT/G, Internal shield		Pin 4 - Cathode #2	
Pin 2 - Heater		Pin 5 - Plate #1	
Pin 3 - Plate #2		Pin 7 - Heater	
RCA Socket		Pin 8 - Cathode #1	
Mounting Position		Stock No. 9924	Any

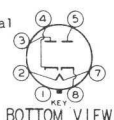

Maximum Ratings Are Design-Center Values

RECTIFIER OR DOUBLER

Peak Inverse Voltage	420 max. volts
Peak Plate Current per Plate	48 max. ma.
D-C Heater-Cathode Potential	330 max. volts

As Half-Wave Rectifier: *

A-C Plate Voltage per Plate (RMS)	117	150 max. volts
Total Effect. Plate-Supply Impedance per Plate [▲]	15 min.	40 min. ohms
D-C Output Current per Plate	8 max.	8 max. ma.

As Voltage Doubler:

	Half-Wave	Full-Wave
A-C Plate Voltage per Plate (RMS)	117	117 volts
Total Effect. Plate-Supply Impedance per Plate [▲]	30 min.	15 min. ohms
D-C Output Current	8 max.	8 max. ma.

^o With shell or external and internal shields connected to cathodes.
 * In half-wave service, the two units may be used separately or in parallel.
 ▲ When a filter-input condenser larger than 40 μf is used, it may be necessary to use more plate-supply impedance than the minimum value shown to limit the peak plate current to the rated value.

Circuits for the 6H6 and 6H6-GT/G are the same as those shown under Type 2525.

← Indicates a change.

6H6



6H6

AVERAGE CHARACTERISTICS
HALF-WAVE RECTIFICATION - SINGLE DIODE

$E_f = 6.3$ VOLTS

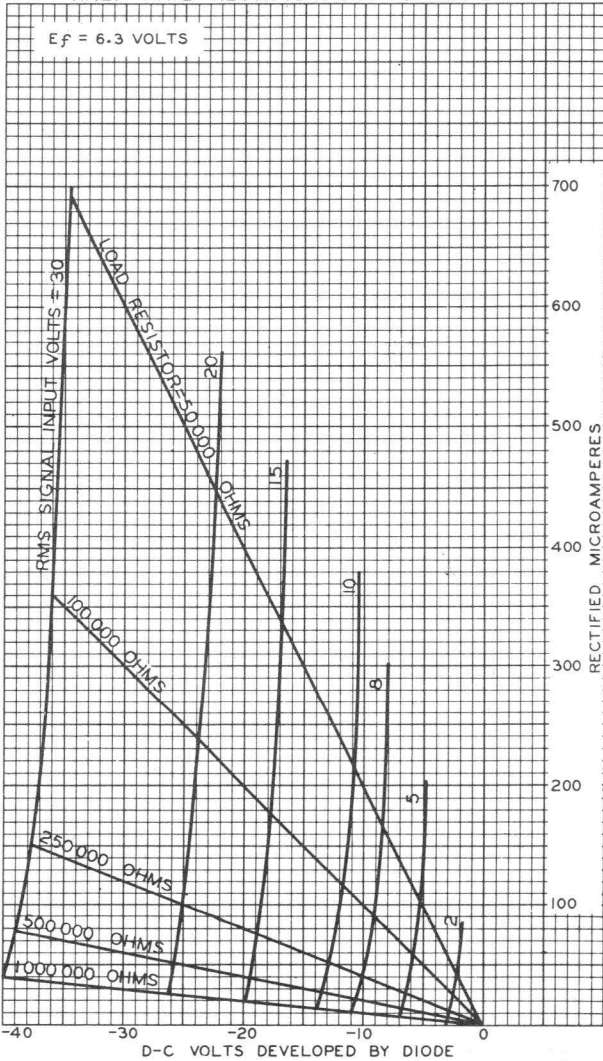

Power Pentode

9-PIN MINIATURE TYPE

GENERAL DATA

Electrical:

Heater Characteristics and Ratings (*Design-Maximum Values*):

Voltage (AC or DC)	6.3 ± 0.6	volts
Current at heater volts = 6.3	0.760	amp
Peak heater-cathode voltage:		
Heater negative with respect to cathode	200 max.	volts
Heater positive with respect to cathode	200 ^a max.	volts
Direct Interelectrode Capacitances (Approx.): ^b		
Grid No.1 to plate	0.18	μf
Grid No.1 to cathode, grid No.3, grid No.2, and heater	13.0	μf
Plate to cathode, grid No.3, grid No.2, and heater	8.0	μf

Characteristics, Class A₁ Amplifier:

Plate Supply Voltage	60	250	250	volts
Grid No.3	<i>Connected to cathode at socket</i>			
Grid-No.2 Supply Voltage	250	125	250	volts
Grid-No.1 Voltage	0	-	-	volts
Cathode Resistor	-	33	100	ohms
Mu-Factor, Grid No.2 to Grid No.1	-	-	33	
Plate Resistance (Approx.)	-	28000	24000	ohms
Transconductance	-	24000	20000	μmhos
Plate Current	150 ^c	40	40	ma
Grid-No.2 Current	37 ^c	4.2	6.2	ma
Grid-No.1 Voltage (Approx.) for plate μ _a = 100	-	-6.4	-13	volts

Mechanical:

Operating Position	Any
Type of Cathode	Coated Unipotential
Maximum Overall Length	3-1/16"
Maximum Seated Length	2-13/16"
Length, Base Seat to Bulb Top (Excluding tip)	2-7/16" ± 3/32"
Diameter	0.750" to 0.850"
Dimensional Outline	See <i>General Section</i>
Bulb	T6-1/2
Basing Designation for BOTTOM VIEW	9PU

- Pin 1 - Cathode
- Pin 2 - Grid No.1
- Pin 3 - Grid No.3
- Pin 4 - Heater
- Pin 5 - Heater

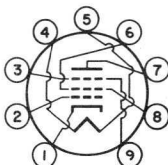

- Pin 6 - Grid No.2
- Pin 7 - Plate
- Pin 8 - Grid No.2
- Pin 9 - Grid No.3



6HB6

VERTICAL-DEFLECTION AMPLIFIER

Maximum Ratings, Design-Maximum Values:

For operation in a 525-line, 30-frame system^d

DC PLATE VOLTAGE.	350 max.	volts
PEAK POSITIVE-PULSE PLATE VOLTAGE ^e . . .	2500 max.	volts
GRID No.3 (SUPPRESSOR GRID) . . .	<i>Connect to cathode at socket</i>	
DC GRID-No.2 (SCREEN-GRID) VOLTAGE. . .	300 max.	volts
GRID No.1 (CONTROL-GRID) VOLTAGE. . . .	-100 max.	volts
GRID-No.2 INPUT	2 max.	watts
PLATE DISSIPATION	10 max.	watts

Maximum Circuit Values:

Grid-No.1-Circuit Resistance:

For fixed-bias operation.	1 max.	megohm
For cathode-bias operation.	2.2 max.	megohms

^a The dc component must not exceed 100 volts.

^b Without external shield.

^c This value can be measured by a method involving a recurrent wave form such that the maximum ratings of the tube will not be exceeded.

^d As described in "Standards of Good Engineering Practice Concerning Television Broadcast Stations," Federal Communications Commission.

^e This rating is applicable when the duration of the voltage pulse does not exceed 15 per cent of one vertical scanning cycle. In a 525-line, 30-frame system, 15 per cent of one vertical scanning cycle is 2.5 milliseconds.



Medium-Mu Triode— Sharp-Cutoff Pentode

9-PIN MINIATURE TYPE

For VHF Oscillator-Mixer Service in TV Receivers

Electrical:

Heater Characteristics and Ratings:

Voltage (AC or DC)	6.3 ± 0.6 ^a	volts
Current at heater volts = 6.3.	0.450 ^b	amp
Warm-up time (Average)	11	sec
Peak heater-cathode voltage:		
Heater negative with respect to cathode	200 max.	volts
Heater positive with respect to cathode	200 ^c max.	volts

Direct Interelectrode Capacitances:^d

Triode Unit:

G _T to P _T	1.9	pf
Input: G _T to (K+G _{3P} +I _S ,H)	3.0	pf
Output: P _T to (K+G _{3P} +I _S ,H)	1.9	pf

Pentode Unit:

G _{1P} to P _P	0.010 max.	pf
Input: G _{1P} to (K+G _{3P} +I _S ,G _{2P} ,H)	5.0	pf
Output: G _{1P} to (K+G _{3P} +I _S ,G _{2P} ,H)	3.4	pf
H to K ^e	3.8	pf

Characteristics, Class A₁ Amplifier:

	Triode Unit	Pentode Unit	
Plate Supply Voltage	150	125	volts
Grid-No.2 Supply Voltage	—	125	volts
Grid-No.1 Supply Voltage	0	-1	volts
Cathode Resistor	56	—	ohms
Amplification Factor	40	—	
Plate Resistance (Approx.)	5000	20000	ohms
Transconductance	8500	6400	μmhos
Plate Current	18	12	ma
Grid-No.2 Current	—	4	ma
Grid-No.1 Voltage (Approx.) for plate μa = 10.	-12	-9	volts

Mechanical:

Operating Position	Any
Type of Cathode	Coated Unipotential
Maximum Overall Length	2-3/16"
Maximum Seated Length	1-15/16"
Length, Base Seat to Bulb Top (Excluding Tip)	1-9/16" ± 3/32"
Diameter	0.750" to 0.875"
Dimensional Outline	See <i>General Section</i>
Bulb	T6-1/2



6HB7

Base Small-Button Noval 9-Pin (JEDEC No. E9-1)
 Basing Designation for BOTTOM VIEW. 9QA

- Pin 1 - Cathode, Pentode
 Grid No. 3,
 Internal Shield
- Pin 2 - Pentode Grid No. 1
- Pin 3 - Same as Pin 1
- Pin 4 - Heater
- Pin 5 - Heater
- Pin 6 - Pentode Plate
- Pin 7 - Pentode Grid No. 2
- Pin 8 - Triode Plate
- Pin 9 - Triode Grid

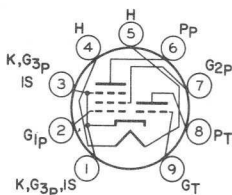

AMPLIFIER — Class A₁

Maximum Ratings, *Design-Maximum Values:*

	<i>Triode Unit</i>	<i>Pentode Unit</i>	
Plate Voltage	330 max.	330 max.	volts
Grid-No. 2 (Screen-Grid) Supply Voltage.	—	330 max.	volts
Grid-No. 2 Voltage	See <i>Grid-No. 2 Input Rating Chart</i> at front of Receiving Tube Section		
Grid-No. 1 (Control-Grid) Voltage:			
Positive-bias value	0 max.	0 max.	volts
Grid-No. 2 Input:			
For grid-No. 2 voltages up to 165 volts	—	0.55 max.	watt
For grid-No. 2 voltages between 165 and 330 volts	See <i>Grid-No. 2 Input Rating Chart</i> at front of Receiving Tube Section		
Plate Dissipation	2.5 max.	3.1 max.	watts

Maximum Circuit Values:

Grid-No. 1 Circuit Resistance:			
For fixed-bias operation.	0.5 max.	0.25 max.	megohm
For cathode-bias operation.	1.0 max.	0.5 max.	megohm

- a For parallel heater operation.
- b For series heater operation current must be limited to 0.450 ± 0.030 amperes.
- c The dc component must not exceed 100 volts.
- d with external shield JEDEC No. 315 connected to cathode except as noted.
- e With external shield JEDEC No. 315 connected to ground.



AVERAGE PLATE CHARACTERISTICS Triode Unit

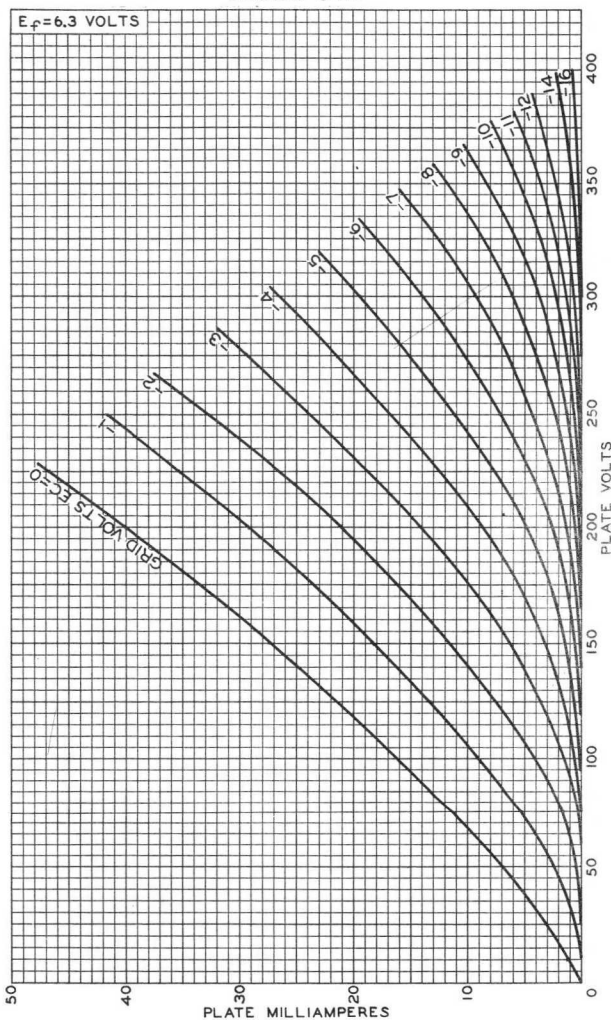

92CM-9866



6HB7

AVERAGE CHARACTERISTICS Triode Unit

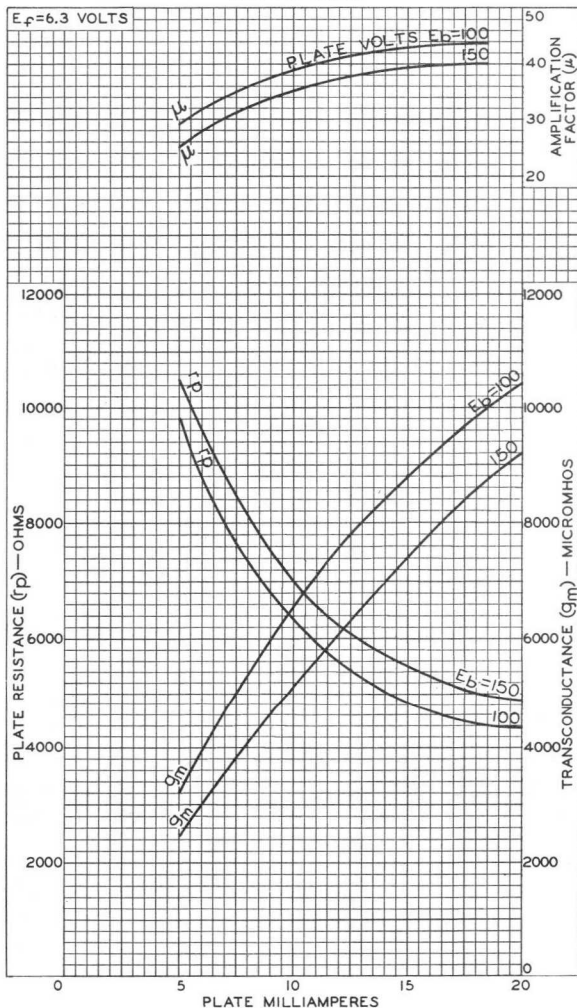

92CM-9882RI



AVERAGE CHARACTERISTICS Pentode Unit

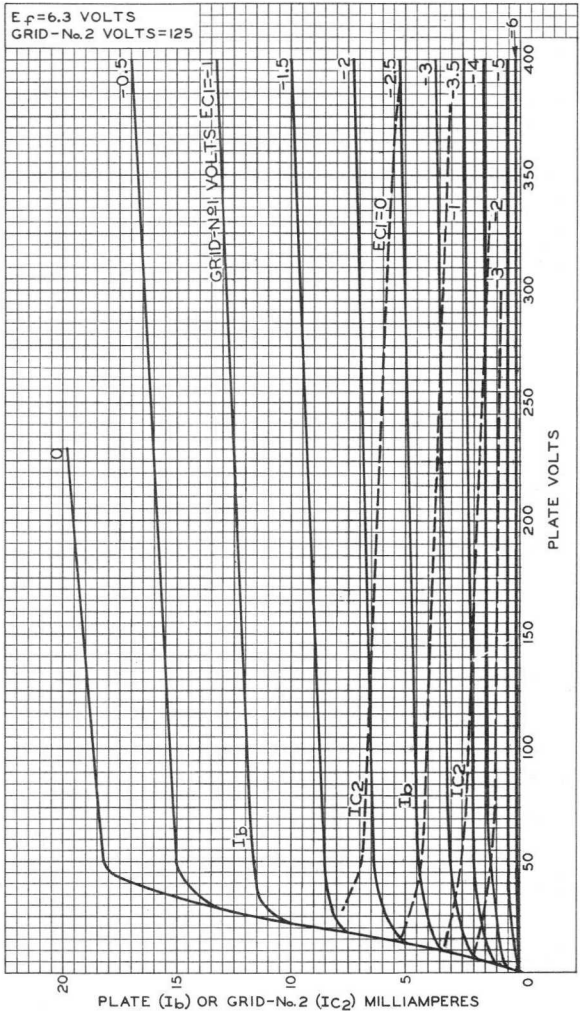

92CM-9867RI



6HB7

AVERAGE CHARACTERISTICS Pentode Unit

$E_f = 6.3$ VOLTS
PLATE VOLTS = 125
GRID-№2 VOLTS = 125

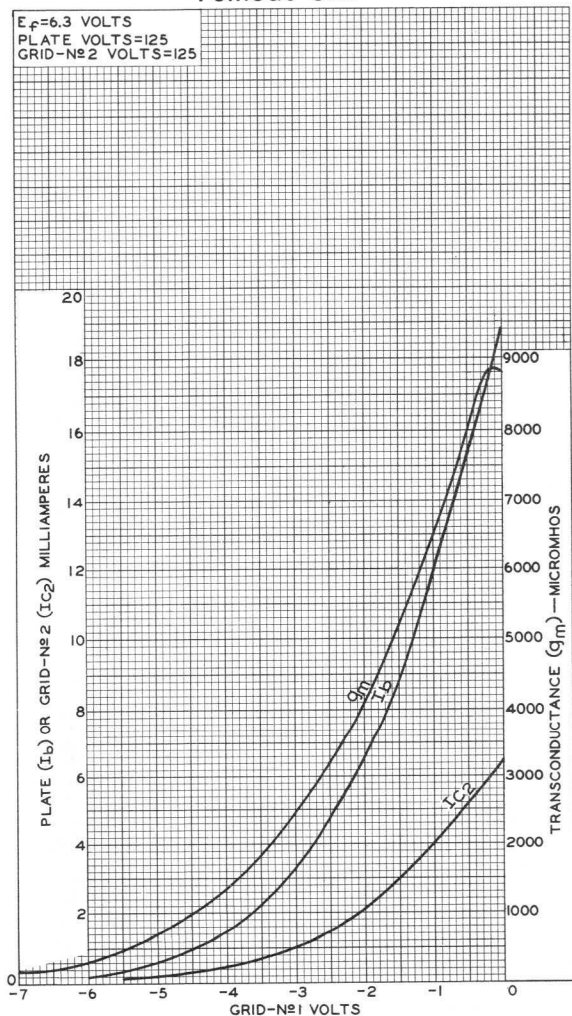

92CM-9868RI



Beam Power Tube

Duodecar Type

For Vertical-Deflection-Amplifier

Circuits in TV Receivers

ELECTRICAL CHARACTERISTICS - Bogey Values

Heater Voltage, ac or dc . . .	E_h	6.3	V
Heater Current	I_h	0.8	A
Direct Interelectrode Capacitances: ^a			
Grid No.1 to plate	c_{g1-p}	0.54	pF
Input: G1 to (K,G3,G2,H)	c_i	9.5	pF
Output: P to (K,G3,G2,H)	c_o	7.0	pF

For the following characteristics, see Conditions below:

Plate Resistance (approx.) . . .	r_p	—	50000	Ω
Transconductance	g_m	—	4100	μmho
DC Plate Current	I_b	180 ^b	43	mA
DC Grid-No.2 Current	I_{c2}	20 ^b	3.5	mA
Cutoff DC Grid-No.1 Voltage for $I_b = 100 \mu\text{A}$	$E_{c1(\text{co})}$	—	-50	V

Conditions:

Heater Voltage	E_h	6.3	6.3	V
DC Plate Voltage	E_b	60	250	V
DC Grid-No.2 Voltage	E_{c2}	250	250	V
DC Grid-No.1 Voltage	E_{c1}	0 ^c	-20	V

MECHANICAL CHARACTERISTICS

Maximum Overall Length	2.875in (73.02 mm)
Maximum Seated Length	2.500in (63.5 mm)
Maximum Diameter	1.188in (30.1 mm)
Dimensional Outline	JEDEC 9-60
Envelope	JEDEC T9
Base	Small-Button Duodecar 12-Pin (JEDEC E12-70)
Terminal Diagram	JEDEC 12EY
Type of Cathode	Coated Unipotential
Operating Position	Any

MAXIMUM RATINGS - Design-Maximum Values^dFor operation as a Vertical-Deflection-Amplifier Tube
in a 525-line, 30-frame system

DC Plate Supply Voltage	E_{bb}	350	V
Peak Positive-Pulse Plate Voltage ^e	e_{bm}	2500	V

6HE5

DC Grid-No.2 (Screen-Grid) Voltage .	E_{c2}	300	V
Heater-Cathode Voltage:			
Peak	e_{hkm}	±200	V
Average	E_{hk}	100	V
Heater Voltage, ac or dc	E_h	5.7 to 6.9	V
Cathode Current:			
Peak	i_{km}	260	mA
Average	$I_{k(av)}$	75	mA
Grid-No.2 Input	P_{g2}	2.75	W
Plate Dissipation ^f	P_b	12	W
Envelope Temperature (at hottest point on envelope surface.)	T_E	200	°C

MAXIMUM CIRCUIT VALUES

Grid-No.1-Circuit Resistance

With fixed bias	R_{g1}	1.0	$M\Omega$
With cathode bias	R_{g1}	2.2	$M\Omega$

- ^a Measured without external shield in accordance with the current issue of EIA Standard RS-191.
- ^b This value can be measured by a method involving a recurrent waveform such that the Maximum Ratings of the tube will not be exceeded.
- ^c Applied for two seconds maximum so as not to damage tube.
- ^d Unless otherwise specified, as defined in the current issue of EIA Standard RS-239.
- ^e This rating is applicable when the duration of the voltage pulse does not exceed 15% of one vertical scanning cycle. In a 525-line, 30-frame system, 15% of one vertical scanning cycle is 2.5 ms.
- ^f An adequate bias resistor or other means is required to protect the tube in the absence of excitation.

TERMINAL DIAGRAM - Bottom View

- Pin 1 - Heater
- Pin 2 - Grid No.1
- Pin 3 - Grid No.2
- Pin 4 - Grid No.3, Cathode
- Pin 5 - No Connection
- Pin 6 - Plate
- Pin 7 - No Connection
- Pin 8 - No Connection
- Pin 9 - Grid No.1
- Pin 10 - Grid No.2
- Pin 11 - Grid No.3, Cathode
- Pin 12 - Heater

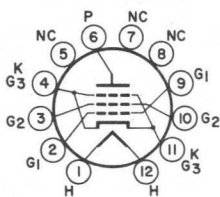

JEDEC 12EY

High-Mu Triode— Sharp-Cutoff Pentode

9-PIN MINIATURE TYPE

GENERAL DATA

Electrical:

Heater, for Unipotential Cathodes:

Voltage (AC or DC)	6.3 ± 10%	volts
Current at 6.3 volts	0.75	amp

Direct Interelectrode Capacitances:▲

Triode Unit:

Grid to plate	3.5	μf
Grid to cathode, pentode cathode & grid No.3 & internal shield, and heater	2.8	μf
Plate to cathode, pentode cathode & grid No.3 & internal shield, and heater	2.6	μf

Pentode Unit:

Grid No.1 to plate	0.1 max.	μf
Grid No.1 to cathode & internal shield & grid No.3, grid No.2, and heater	10	μf
Plate to cathode & internal shield & grid No.3, grid No.2, and heater	4.2	μf
Triode grid to pentode plate	0.015 max.	μf

Characteristics, Class A₁ Amplifier:

	Triode Unit	Pentode Unit	
Plate Supply Voltage	200	45	200 volts
Grid-No.2 Supply Voltage	—	125	125 volts
Grid-No.1 Voltage	-2	0	— volts
Cathode Resistor	—	—	68 ohms
Amplification Factor	70	—	—
Plate Resistance (Approx.)	17500	—	75000 ohms
Transconductance	4000	—	12500 μmhos
Plate Current	4	40●	25 ma
Grid-No.2 Current	—	15●	7 ma
Grid-No.1 Voltage (Approx.) for plate μa = 100	—	—	-9 volts
Grid-No.1 Voltage (Approx.) for plate μa = 20	-6	—	— volts

Mechanical:

Operating Position	Any
Maximum Overall Length	2-5/8"
Maximum Seated Length	2-3/8"



6HF8

Length, Base Seat to Bulb Top (Excluding tip) . . . 2" \pm 3/32"
 Diameter 0.750" to 0.875"
 Dimensional Outline. See *General Section*
 Bulb T6-1/2
 Base Small-Button Noval 9-Pin (JEDEC No.E9-1)
 Basing Designation for BOTTOM VIEW 9DX

Pin 1 - Triode
 Cathode

Pin 2 - Triode
 Grid

Pin 3 - Triode
 Plate

Pin 4 - Heater

Pin 5 - Heater

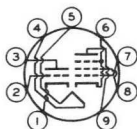

Pin 6 - Pentode
 Cathode,
 Grid No.3,
 Internal
 Shield

Pin 7 - Pentode
 Grid No.1

Pin 8 - Pentode
 Grid No.2

Pin 9 - Pentode
 Plate

AMPLIFIER — Class A₁

Maximum Ratings, Design-Maximum Values:

	<i>Triode Unit</i>	<i>Pentode Unit</i>	
PLATE VOLTAGE.	330 max.	330 max.	volts
GRID-No.2 (SCREEN-GRID) SUPPLY VOLTAGE	-	330 max.	volts
GRID-No.2 VOLTAGE.	-	See <i>Grid-No.2 Input</i>	
<i>Rating Chart</i> at front of Receiving Tube Section			
GRID-No.1 (CONTROL-GRID) VOLTAGE:			
Positive-bias value.	0 max.	0 max.	volts
GRID-No.2 INPUT:			
For grid-No.2 voltages up to 165 volts.	-	1.1 max.	watts
For grid-No.2 voltages between 165 and 330 volts.	-	See <i>Grid-No.2 Input</i>	
<i>Rating Chart</i> at front of Receiving Tube Section			
PLATE DISSIPATION.	1 max.	5 max.	watts
PEAK HEATER-CATHODE VOLTAGE:			
Heater negative with respect to cathode	200 max.	200 max.	volts
Heater positive with respect to cathode	200* max.	200* max.	volts

Maximum Circuit Values:

	<i>Triode Unit</i>	<i>Pentode Unit</i>	
Grid-No.1-Circuit Resistance:			
For fixed-bias operation	0.5 max.	0.25 max.	megohm
For cathode-bias operation.	1 max.	1 max.	megohm



- ▲ Without external shield.
- This value can be measured by a method involving a recurrent wave form such that the maximum ratings of the tube will not be exceeded.
- ★ The dc component must not exceed 100 volts.



6HF8

AVERAGE PLATE CHARACTERISTICS Triode Unit

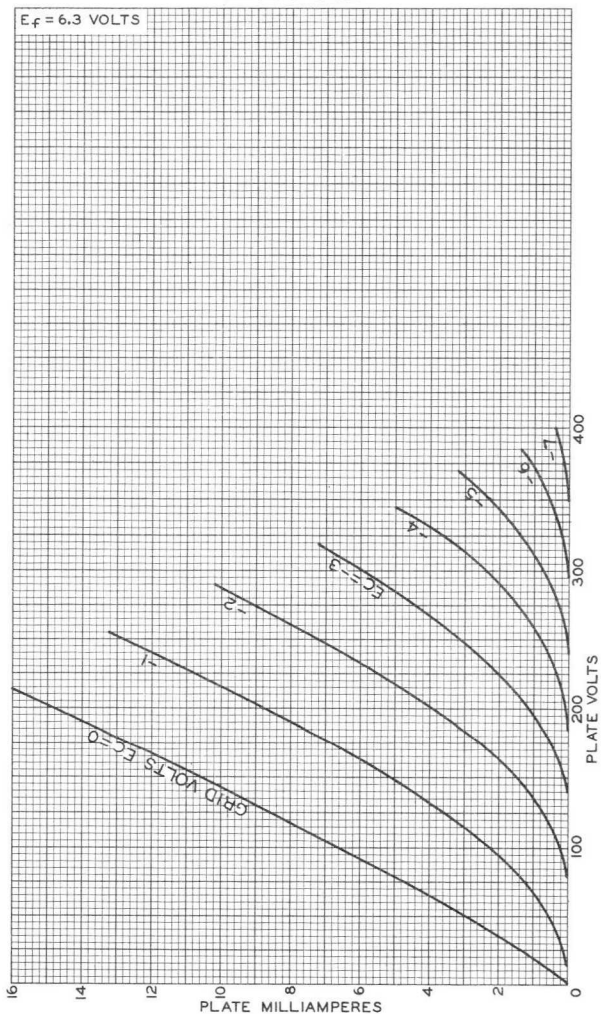

92CM-8644

RADIO CORPORATION OF AMERICA
Electron Tube Division

Harrison, N. J.



AVERAGE CHARACTERISTICS Triode Unit

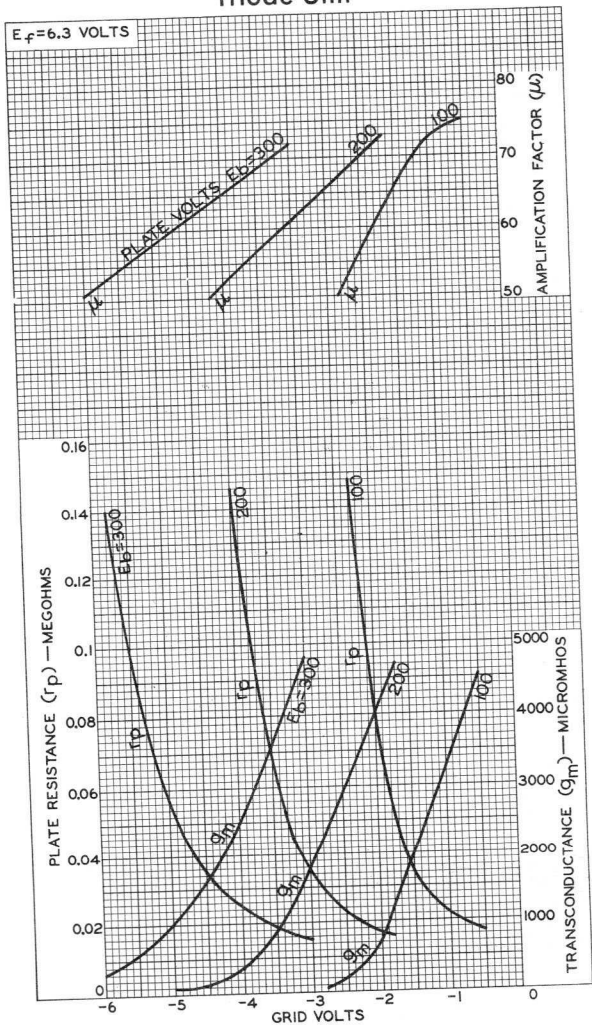

92CM-10874



6HF8

AVERAGE CHARACTERISTICS Pentode Unit

$E_f = 6.3$ VOLTS
GRID-N ϕ 2 VOLTS = 125

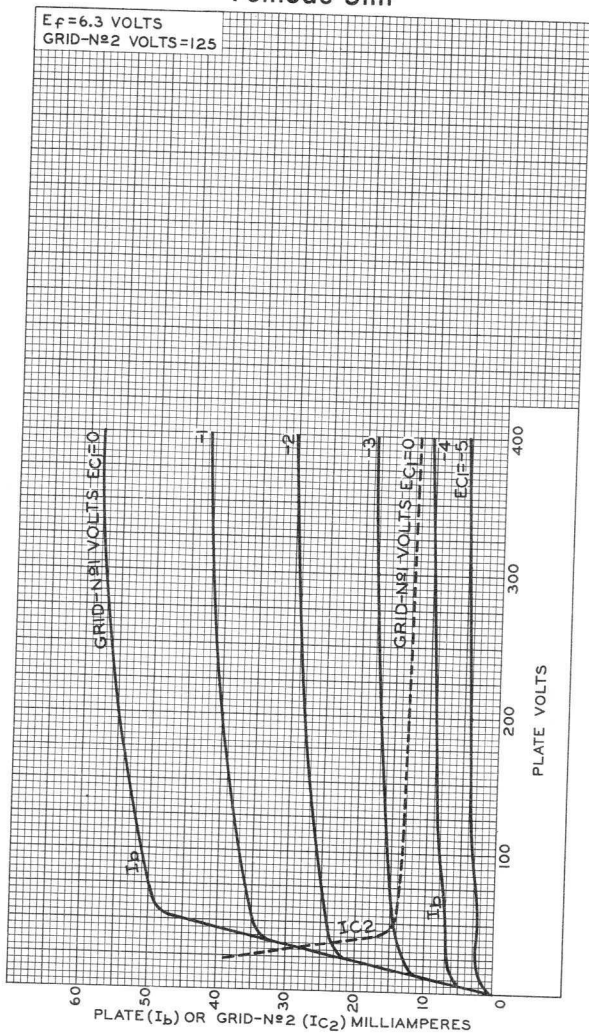

92CM-9906

RADIO CORPORATION OF AMERICA
Electron Tube Division

Harrison, N. J.



AVERAGE CHARACTERISTICS

Pentode Unit

$E_f = 6.3$ VOLTS
 PLATE VOLTS = 200
 GRID-N \circ 2 VOLTS = 125

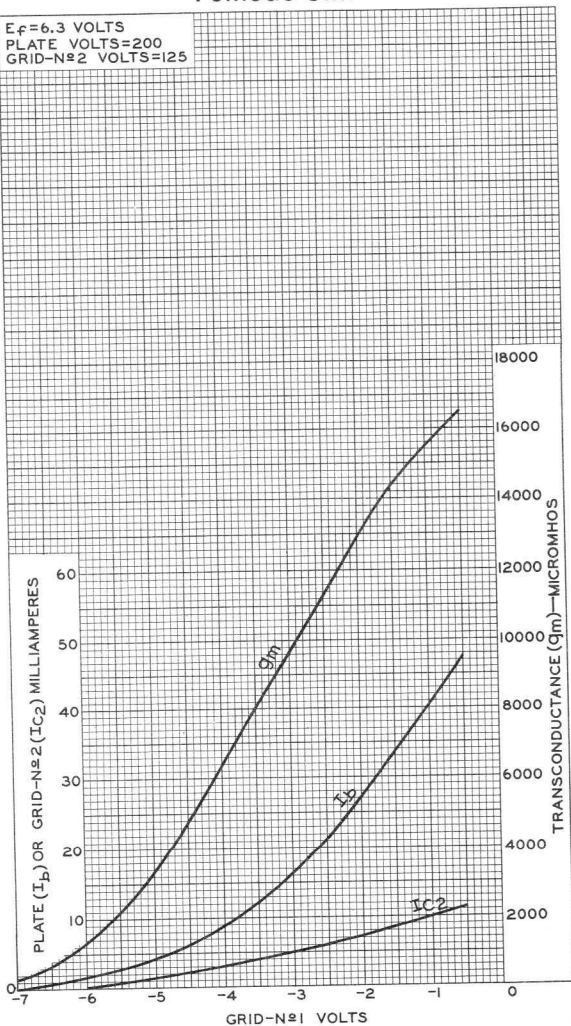

92CM-9905RI





Beam Power Tube

7-PIN MINIATURE TYPE
 CONTROLLED CATHODE WARM-UP TIME MINIMIZES
 EXTRANEIOUS SOUND DURING RECEIVER WARM UP.

For Use in the Audio Output Stages of Television Receivers

Electrical:

Heater Characteristics and Ratings:

Voltage (AC or DC)	6.3 ± 0.6 volts
Current at heater volts = 6.3	0.450 amp
Peak heater-cathode voltage:	
Heater negative with respect to cathode	200 max. volts
Heater positive with respect to cathode	200 ^a max. volts

Minimum Cathode Warm-up Time:^b

Heater volts = 6.3, plate and grid-No.2 volts = 250, and cathode resistor (ohms) = 680.	14	sec
---	----	-----

Direct Interelectrode Capacitances

(Approx.):

G1 to P	0.4	pf
Input: G1 to (K+G3, G2, H).	8.0	pf
Output: P to (K+G3, G2, H)	8.5	pf

Mechanical:

Operating Position	Any
Type of Cathode	Coated Unipotential
Maximum Overall Length	2-5/8"
Maximum Seated Length	2-3/8"
Length, Base Seat to Bulb Top. (Excluding Tip).	2" ± 3/32"
Diameter	0.650" to 0.750"
Dimensional Outline	See <i>General Section</i>
Bulb	T5-1/2
Base	Small-Button Miniature 7-Pin (JEDEC No. E7-1)
Basing Designation for BOTTOM VIEW	7BZ

Pin 1 - Grid No.1
 Pin 2 - Cathode,
 Grid No.3
 Pin 3 - Heater

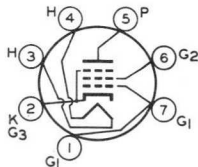

Pin 4 - Heater
 Pin 5 - Plate
 Pin 6 - Grid No.2
 Pin 7 - Grid No.1

AMPLIFIER - Class A₁

Maximum Ratings, Design-Maximum Values:

Plate Voltage	275 max.	volts
Grid-No.2 (Screen-Grid) Voltage	275 max.	volts
Grid-No.2 Input	2 max.	watts



6HG5

Plate Dissipation.	12 max.	watts
Bulb Temperature (At hottest point on bulb surface).	250 max.	°C

Typical Operation and Characteristics:

Plate Voltage.	180	250	volts
Grid-No.2 Voltage.	180	250	volts
Grid-No.1 (Control-Grid) Voltage	-8.5	-12.5	volts
Peak AF Grid-No.1 Voltage.	8.5	12.5	volts
Zero-Signal Plate Current.	29	45	ma
Max.-Signal Plate Current.	30	47	ma
Zero-Signal Grid-No.2 Current.	3	4.5	ma
Max.-Signal Grid-No.2 Current.	4	7	ma
Plate Resistance (Approx.)	58000	52000	ohms
Transconductance	3700	4100	μmhos
Load Resistance.	5500	5000	ohms
Total Harmonic Distortion.	8	8	%
Max.-Signal Power Output	2	4.5	watts

Maximum Circuit Values:

Grid-No.1-Circuit Resistance:

For fixed-bias operation	0.1 max.	megohm
For cathode-bias operation	0.5 max.	megohm

^a The dc component must not exceed 100 volts.

^b The time interval between the instant all electrode voltages are applied and the instant a current of one milliamperere flows in the plate circuit of the 6HG5.



AVERAGE CHARACTERISTICS

$E_f = 6.3$ VOLTS
 GRID-No. 2 VOLTS = 250

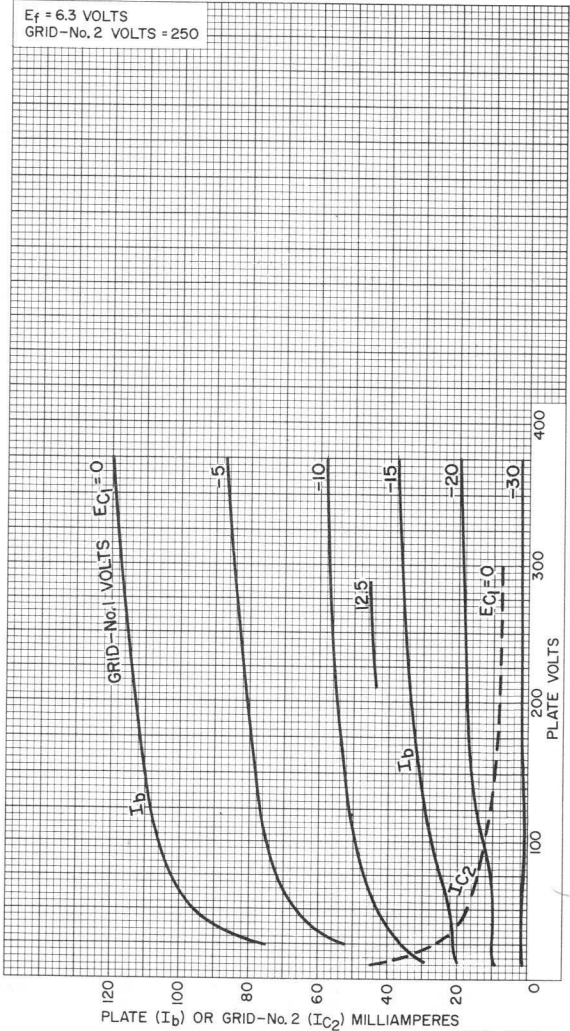

92CM-12368



6HG5

OPERATION CHARACTERISTICS

$E_f = 6.3$ VOLTS PLATE VOLTS = 250 GRID-NO.2 VOLTS = 250
GRID-NO.1 VOLTS = -12.5 SIGNAL VOLTS (RMS) = 8.8

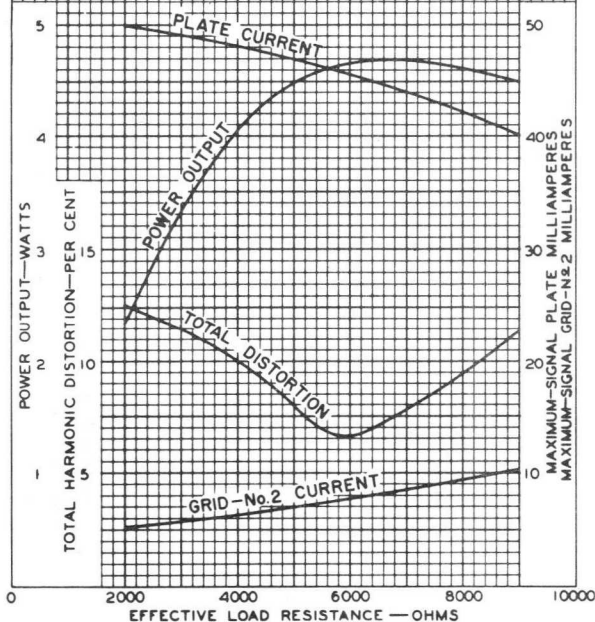

92CM-6339R2



Diode—Sharp-Cutoff Pentode

With Heater Having Controlled Warm-Up Time

GENERAL DATA

Electrical:

Heater Characteristics and Ratings (*Design-Maximum Values*):

Voltage (AC or DC)	6.3 ^a	6.3 ± 0.6	volts
Current	0.450 ± 0.030	0.450 ^b	amp
Warm-up time (Average)	11	—	sec

Peak heater-cathode

voltage (Each unit):

Heater negative with respect to cathode	200 ^c max.	volts
Heater positive with respect to cathode	200 ^c max.	volts

Direct Interelectrode Capacitances:^d

Diode Unit:

Plate to cathode and heater	2.4	μf
Cathode to plate and heater	3.0	μf

Pentode Unit:

Grid No.1 to plate	0.015 max.	μf
Grid No.1 to cathode, grid No.3 & internal shield, grid No.2, and heater	7.0	μf
Plate to cathode, grid No.3 & internal shield, grid No.2, and heater	3.2	μf
Diode plate to pentode grid No.1	0.005 max.	μf
Diode cathode to pentode plate	0.15 max.	μf
Diode plate to pentode plate	0.035 max.	μf

Characteristics, Class A₁ Amplifier:

Plate Supply Voltage	125	volts
Grid No.3	Connected to cathode at socket	
Grid-No.2 Supply Voltage	125	volts
Cathode Resistor	56	ohms
Plate Resistance (Approx.)	0.2	megohm
Transconductance	9300	μmhos
Plate Current	11.5	ma
Grid-No.2 Current	3.6	ma
Grid-No.1 Voltage (Approx.) for plate μa = 20	-6	volts
Grid-No.1 Voltage (Approx.) for plate ma = 2, and cathode resistor (ohms) = 0	-3	volts

Mechanical:

Operating Position	Any
Type of Cathodes	Coated Unipotential
Maximum Overall Length	2-3/16"
Maximum Seated Length	1-15/16"
Length, Base Seat to Bulb Top (Excluding tip)	1-9/16" ± 3/32"



6HJ8

Diameter 0.750" to 0.875"
 Dimensional Outline See *General Section*
 Bulb T6-1/2
 Base Small-Button Noval 9-Pin (JEDEC No. E9-1)
 Basing Designation for BOTTOM VIEW 9CY

Pin 1 - Pentode Cathode
 Pin 2 - Pentode Grid No.1
 Pin 3 - Pentode Grid No.2
 Pin 4 - Heater
 Pin 5 - Heater
 Pin 6 - Pentode Plate

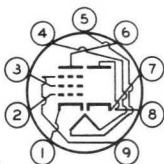

Pin 7 - Diode Cathode
 Pin 8 - Diode Plate
 Pin 9 - Pentode Grid No.3, Internal Shield

PENTODE UNIT — Class A₁ Amplifier

Maximum Ratings, Design-Maximum Values:

PLATE VOLTAGE 330 max. volts
 GRID No.3 (SUPPRESSOR GRID) Connect to cathode at socket
 GRID-No.2 (SCREEN-GRID) SUPPLY VOLTAGE . . . 330 max. volts
 GRID-No.2 VOLTAGE See *Grid-No.2 Input Rating Chart*
 at front of Receiving Tube Section
 GRID-No.1 (CONTROL-GRID) VOLTAGE:
 Positive-bias value 0 max. volts
 GRID-No.2 INPUT:
 For grid-No.2 voltages up to 165 volts. . 0.55 max. watt
 For grid-No.2 voltages between 165
 and 330 volts See *Grid-No.2 Input Rating Chart*
 at front of Receiving Tube Section
 PLATE DISSIPATION 3.2 max. watts

Maximum Circuit Values:

Grid-No.1-Circuit Resistance:
 For fixed-bias operation 0.25 max. megohm
 For cathode-bias operation 1 max. megohm

DIODE UNIT

Maximum Ratings, Design-Maximum Values:

DC PLATE CURRENT 5 max. ma

Characteristics, Instantaneous Value:

Plate Current for plate volts = 10. 50 ma

a At heater amperes = 0.450.
 b At heater volts = 6.3.
 c The dc component must not exceed 100 volts.
 d Without external shield.



Medium-Mu Triode— Sharp-Cutoff Pentode

9-PIN MINIATURE TYPE

For Video and Bandpass Amplifier Applications in TV Receivers

Electrical:

Heater Characteristics and Ratings:

Voltage (AC or DC)	6.3 ± 0.6 ^a	volts
Current at heater volts = 6.3	0.600 ^b	amp
Warm-up time (Average)	11	sec
Peak heater-cathode voltage (Each unit):		
Heater negative with respect to cathode	200 max.	volts
Heater positive with respect to cathode	200 ^c max.	volts

Direct Interelectrode Capacitances:

	Without External Shield	With External Shield ^d	
<i>Triode Unit:</i>			
G _T to P _T	2.8	2.8	pf
Input: G _T to (K _T , K _P +G _{3P} +IS, H)	2.8	3.0	pf
Output: P _T to (K _T , K _P +G _{3P} +IS, H)	1.6	2.4	pf

Pentode Unit:

G _{1P} to P _P	0.030 max.	0.026 max.	pf
Input: G _{1P} to (K _P +G _{3P} +IS, G _{2P} , H)	7.5	7.5	pf
Output: P _P to (K _P +G _{3P} +IS, G _{2P} , H)	2.4	3.0	pf

Mechanical:

Operating Position	Any
Type of Cathodes	Coated Unipotential
Maximum Overall Length	2-3/16"
Maximum Seated Length	1-15/16"
Length, Base Seat to Bulb Top (Excluding tip)	1-9/16" ± 3/32"
Diameter	0.750" to 0.875"
Dimensional Outline	See <i>General Section</i>
Bulb	T6-1/2
Base	Small-Button Noval 9-Pin (JEDEC No. E9-1)
Basing Designation for BOTTOM VIEW	9AE

- Pin 1—Triode Plate
- Pin 2—Pentode Grid No.1
- Pin 3—Pentode Grid No.2
- Pin 4—Heater
- Pin 5—Heater
- Pin 6—Pentode Plate
- Pin 7—Pentode Cathode,
Grid No.3,
Internal Shield
- Pin 8—Triode Cathode
- Pin 9—Triode Grid

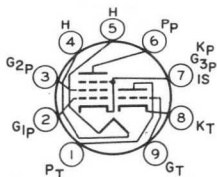

6HL8

Characteristics:

	Triode Unit	Pentode Unit	
Plate Voltage.	125	125	volts
Grid-No.2 Voltage.	-	125	volts
Grid-No.1 Voltage.	-1	-1	volt
Amplification Factor	40	-	
Plate Resistance (Approx.)	5000	150000	ohms
Transconductance	7000	10000	μ mhos
Plate Current.	12.5	12	ma
Grid-No.2 Current.	-	4.5	ma
Grid-No.1 Voltage (Approx.) for plate μ a = 20.	-	-7	volts

AMPLIFIER — Class A₁

Maximum Ratings, Design-Maximum Values:

	Triode Unit	Pentode Unit	
Plate Voltage.	330 max.	330 max.	volts
Grid-No.2 (Screen-Grid) Supply Voltage	-	330 max.	volts
Grid-No.2 Voltage.	See <i>Grid-No.2 Input Rating Chart</i> at front of Receiving Tube Section		
Grid-No.1 (Control-Grid) Voltage:			
Positive-bias value.	0 max.	0 max.	volts
Grid-No.2 Input:			
For grid-No.2 voltages up to 165 volts.	-	0.55 max.	watt
For grid-No.2 voltages between 165 and 330 volts.	See <i>Grid-No.2 Input Rating Chart</i> at front of Receiving Tube Section		
Plate Dissipation.	2.5 max.	2.5 max.	watts

Maximum Circuit Values:

Grid-No.1-Circuit Resistance:			
For fixed-bias operation	1 max.	0.25 max.	megohm
For self-bias operation.	1 max.	1 max.	megohm

a For parallel heater operation.

b For series heater operation current must be limited to 0.600 ± 0.040 amperes.

c The dc component must not exceed 100 volts.

d With external shield, JEDEC No.315, connected to cathode of unit under test.



6HM5/6HA5

High-Mu Triode

7-PIN MINIATURE TYPE

Useful as Grounded-Cathode RF-Amplifier Tube in VHF Tuners

Electrical:

Heater Characteristics and Ratings:

Voltage (AC or DC)	6.3 ± 0.6	volts
Current at heater volts = 6.3	0.180	amp
Peak heater-cathode voltage:		
Heater negative with respect to cathode	110 max.	volts
Heater positive with respect to cathode	110 max.	volts

Direct Interelectrode Capacitances:^a

Grid to plate	0.36	pf
Grid to cathode, internal shield, external shield, and heater	4.3	pf
Plate to cathode, internal shield, external shield, and heater	2.9	pf
Cathode to plate	0.080	pf
Cathode to grid, internal shield, external shield, and heater	3.1	pf
Heater to cathode	2.3	pf
Heater to grid	0.070 max.	pf

Characteristics, Class A₁ Amplifier:

Plate Voltage	135	volts
Grid Voltage	-1	volt
Amplification Factor	72	
Plate Resistance (Approx.)	5000	ohms
Transconductance	14500	μmhos
Plate Current	11.5	ma
Grid Voltage (Approx.) for Transconductance (μmhos) = 150	-5.7	volts

Mechanical:

Operating Position	Any
Type of Cathode	Coated Unipotential
Maximum Overall Length	2-1/8"
Maximum Seated Length	1-7/8"
Length, Base Seat to Bulb Top (Excluding tip)	1-1/2" ± 3/32"
Diameter	0.650" to 0.750"
Dimensional Outline	See <i>General Section</i>
Bulb	T5-1/2
Base	Small-Button Miniature 7-Pin (JEDEC No. E7-1)



6HM5/6HA5

Basing Designation for BOTTOM VIEW. 7GM

Pin 1 - Grid
 Pin 2 - Cathode
 Pin 3 - Heater
 Pin 4 - Heater

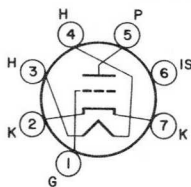

Pin 5 - Plate
 Pin 6 - Internal Shield
 Pin 7 - Cathode

AMPLIFIER - Class A₁

Maximum Ratings, Design-Maximum Values:

Plate Supply Voltage.	600 max.	volts
Plate Voltage	220 max.	volts
Grid Voltage:		
Negative-bias value	50 max.	volts
Positive-bias value	0 max.	volts
Cathode Current	22 max.	ma
Plate Dissipation	2.6 max.	watts

Typical Operation:

Plate Voltage	135	volts
Grid Voltage. Adjusted for grid $\mu a = 10$		
Plate Load Resistance	1000	ohms
Amplification Factor.	80	
Plate Resistance (Approx.).	4000	ohms
Transconductance.	20000	μ hos
Plate Current	19	ma

Maximum Circuit Values:

Grid-Circuit Resistance:		
For fixed-bias operation.	1 max.	megohm
For cathode-bias operation.	1 max.	megohm

^a With external shield JEDEC No.316 connected to cathode.



6HM5/6HA5

AVERAGE CHARACTERISTICS

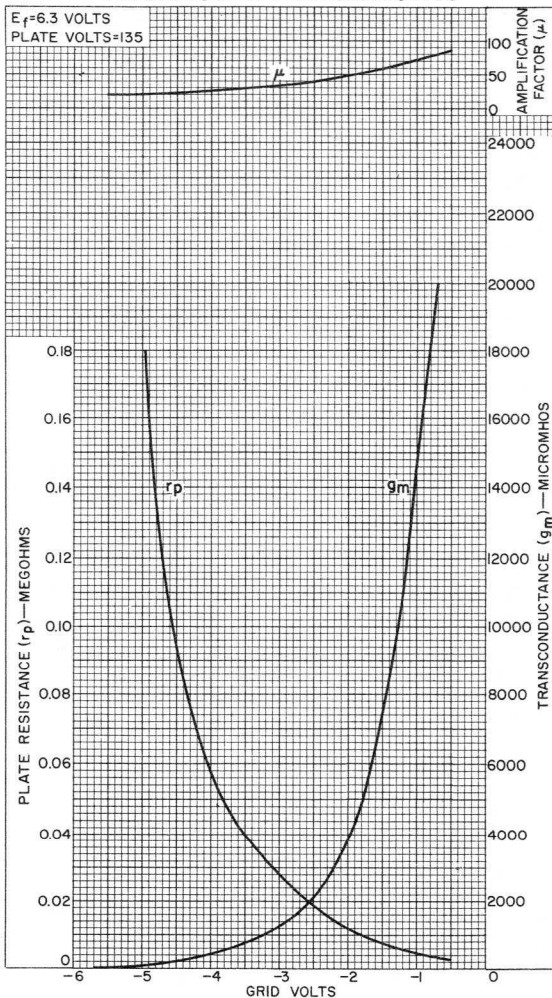

92CM-12224



RADIO CORPORATION OF AMERICA
Electronic Components and Devices
Harrison, N. J.

DATA 2
10-63

6HM5/6HA5

AVERAGE PLATE CHARACTERISTICS

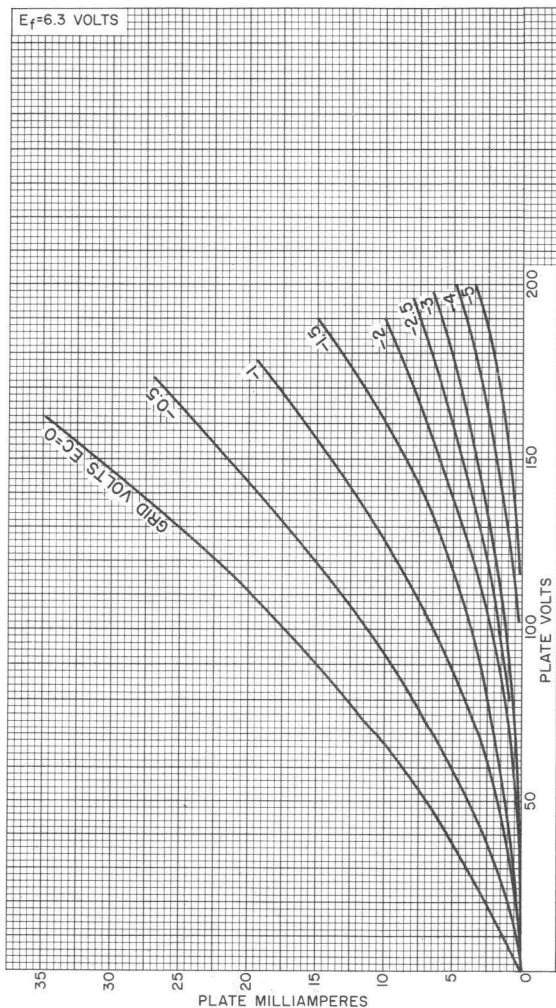

92CM-12223



Semiremote-Cutoff Pentode

7-PIN MINIATURE TYPE

For Intermediate-Frequency-Amplifier Applications in FM, AM, and AM/FM Receivers
With Heater Having Controlled Warm-Up Time

GENERAL DATA

Electrical:

Heater Characteristics and Ratings (*Design-Maximum Values*):

Voltage (AC or DC)	6.3 ^a	6.3 ± 0.6	volts
Current	0.450 ± 0.030	0.450 ^b	amp
Warm-up time (Average)	11	-	sec
Peak heater-cathode voltage:			

Heater negative with respect to cathode	200	max.	volts
Heater positive with respect to cathode	200 ^c	max.	volts

Direct Interelectrode Capacitances:^d

Grid No.1 to plate	0.006	max.	μf
Grid No.1 to cathode, grid No.3 & internal shield, grid No.2, and heater	8.8		μf
Plate to cathode, grid No.3 & internal shield, grid No.2, and heater	5.2		μf

Characteristics, Class A₁ Amplifier:

Plate Supply Voltage	200	volts
Grid No.3	<i>Connected to cathode at socket</i>	
Grid-No.2 Supply Voltage	115	volts
Grid-No.1 Supply Voltage	0	volts
Cathode Resistor	68	ohms
Plate Resistance (Approx.)	0.5	megohm
Transconductance	8500	μmhos
Plate Current	13.2	ma
Grid-No.2 Current	4.3	ma
Grid-No.1 Voltage (Approx.) for transconductance (μmhos) = 60	-15	volts

Mechanical:

Operating Position	Any
Type of Cathode	Coated Unipotential
Maximum Overall Length	2-1/8"
Maximum Seated Length	1-7/8"
Length, Base Seat to Bulb Top (Excluding tip)	1-1/2" ± 3/32"
Diameter	0.650" to 0.750"
Dimensional Outline	See <i>General Section</i>
Bulb	T5-1/2
Base	Small-Button Miniature 7-Pin (JEDEC No.E7-1)



6HR6

Basing Designation for BOTTOM VIEW. 7BK

Pin 1-Grid No.1
Pin 2-Grid No.3,
Internal
Shield
Pin 3-Heater

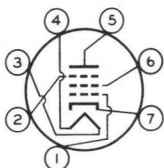

Pin 4-Heater
Pin 5-Plate
Pin 6-Grid No.2
Pin 7-Cathode

AMPLIFIER — Class A₁

Maximum Ratings, Design-Maximum Values:

PLATE VOLTAGE 300 max. volts
GRID No.3 (SUPPRESSOR GRID) Connect to cathode at socket
GRID-No.2 (SCREEN-GRID) SUPPLY VOLTAGE. . . 300 max. volts
GRID-No.2 VOLTAGE See Grid-No.2 Input Rating Chart
at front of Receiving Tube Section

GRID-No.1 (CONTROL-GRID) VOLTAGE:
Negative-bias value 50 max. volts
Positive-bias value 0 max. volts

GRID-No.2 INPUT:
For grid-No.2 voltages
up to 150 volts 1 max. watt
For grid-No.2 voltages be-
tween 150 and 300 volts . See Grid-No.2 Input Rating Chart
at front of Receiving Tube Section

PLATE DISSIPATION 3 max. watts

Maximum Circuit Values:

Grid-No.1-Circuit Resistance:
For fixed-bias operation. 0.5 max. megohm
For cathode-bias operation. 1 max. megohm

- a At heater amperes = 0.450.
- b At heater volts = 6.3.
- c The dc component must not exceed 100 volts.
- d without external shield.



AVERAGE CHARACTERISTICS

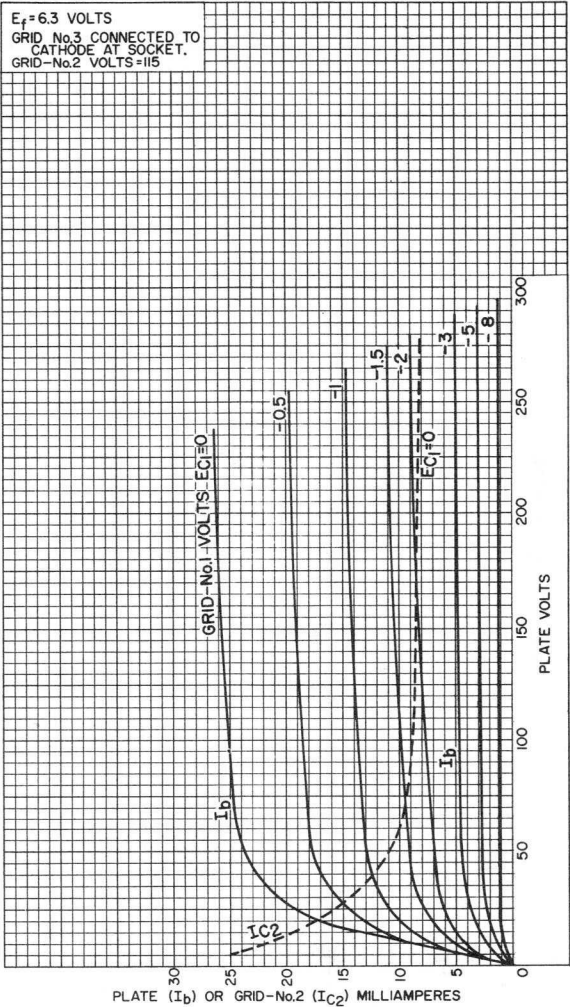

6HR6

AVERAGE CHARACTERISTICS

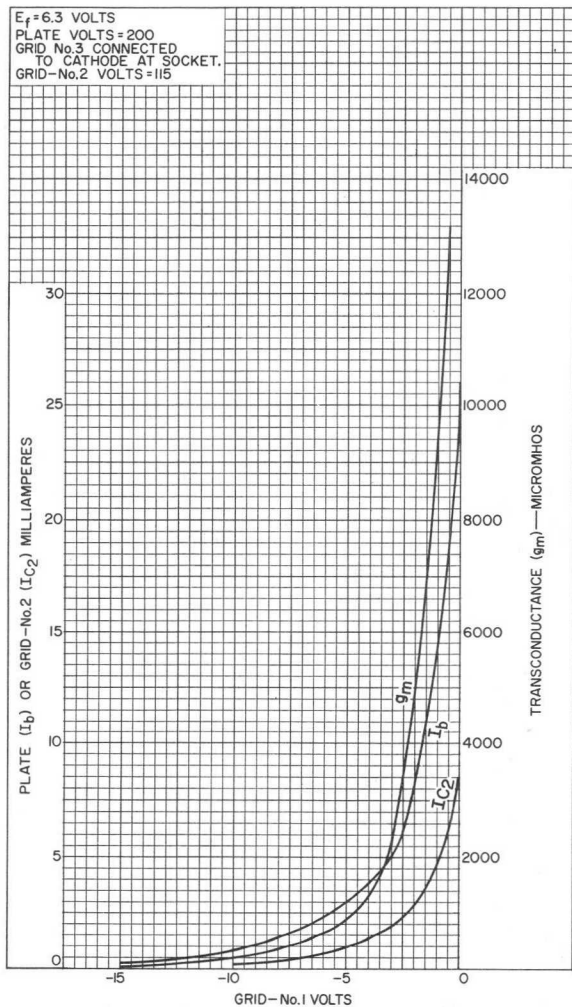

92CM-11533



Sharp-Cutoff Pentode

7-PIN MINIATURE TYPE

With Heater Having Controlled Warm-Up Time

GENERAL DATA

Electrical:

Heater Characteristics and Ratings (<i>Design-Maximum Values</i>):			
Voltage (AC or DC)	6.3 ^a	6.3 ± 0.6	volts
Current	0.450 ± 0.030	0.450 ^b	amp
Warm-up time (Average)	11	-	sec
Peak heater-cathode voltage:			
Heater negative with respect to cathode	200	max.	volts
Heater positive with respect to cathode	200 ^c	max.	volts
Direct Interelectrode Capacitances: ^d			
Grid No.1 to plate	0.006	max.	μf
Grid No.1 to cathode, grid No.3 & internal shield, grid No.2, and heater	8.8		μf
Plate to cathode, grid No.3 & internal shield, grid No.2, and heater	5.2		μf

Characteristics, Class A₁ Amplifier:

Plate Supply Voltage	75	150	volts
Grid No.3	Connected to cathode at socket		
Grid-No.2 Supply Voltage	75	75	volts
Grid-No.1 Supply Voltage	0	0	volts
Cathode Resistor	68	68	ohms
Amplification Factor ^e	50	-	
Plate Resistance (Approx.)	-	0.5	megohm
Transconductance	-	9500	μmhos
Plate Current	-	8.8	ma
Grid-No.2 Current	-	2.8	ma
Grid-No.1 Voltage (Approx.) for plate μa = 20	-	-4	volts

Mechanical:

Operating Position	Any
Type of Cathode	Coated Unipotential
Maximum Overall Length	2-1/8"
Maximum Seated Length	1-7/8"
Length, Base Seat to Bulb Top (Excluding tip)	1-1/2" ± 3/32"
Diameter	0.650" to 0.750"
Dimensional Outline	See <i>General Section</i>
Bulb	T5-1/2
Base	Small-Button Miniature 7-Pin (JEDEC No.E7-1)



6HS6

Basing Designation for BOTTOM VIEW. 7BK

Pin 1-Grid No.1
Pin 2-Grid No.3,
Internal
Shield
Pin 3-Heater

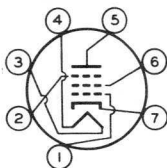

Pin 4-Heater
Pin 5-Plate
Pin 6-Grid No.2
Pin 7-Cathode

AMPLIFIER — Class A₁

Maximum Ratings, Design-Maximum Values:

PLATE VOLTAGE.	300 max.	volts
GRID No.3 (SUPPRESSOR GRID).	Connect to cathode at socket	
GRID-No.2 (SCREEN-GRID)		
SUPPLY VOLTAGE.	300 max.	volts
GRID-No.2 VOLTAGE.	See Grid-No.2 Input Rating Chart at front of Receiving Tube Section	
GRID-No.1 (CONTROL-GRID) VOLTAGE:		
Negative-bias value.	50 max.	volts
Positive-bias value.	0 max.	volts
GRID-No.2 INPUT:		
For grid-No.2 voltages up to 150 volts	1 max.	watt
For grid-No.2 voltages between 150 and 300 volts.	See Grid-No.2 Input Rating Chart at front of Receiving Tube Section	
PLATE DISSIPATION.	3 max.	watts

Maximum Circuit Values:

Grid-No.1-Circuit Resistance:		
For fixed-bias operation	0.5 max.	megohm
For cathode-bias operation	1 max.	megohm

- a At heater amperes = 0.450.
- b At heater volts = 6.3.
- c The dc component must not exceed 100 volts.
- d Without external shield.
- e Triode connection (Grid No.2 connected to plate).



AVERAGE CHARACTERISTICS

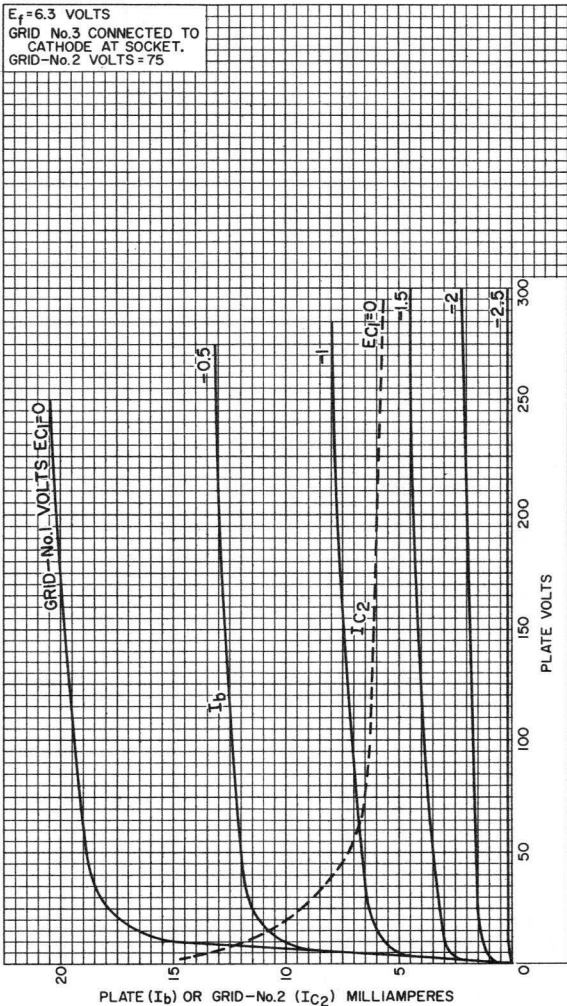

92CM-11483



AVERAGE CHARACTERISTICS

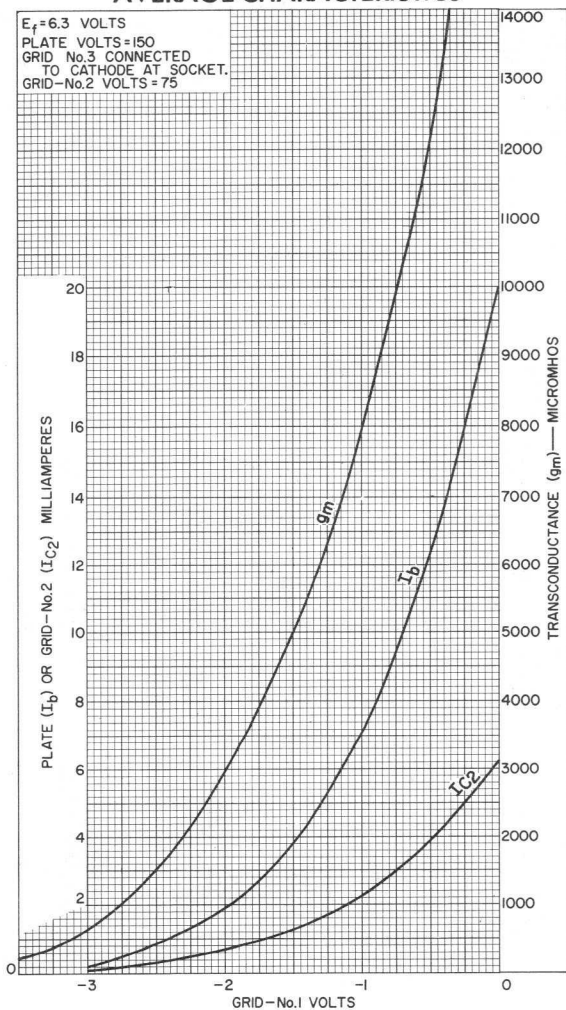

92CM-11484



Sharp-Cutoff Twin Pentode

With Common Cathode, Grid No.1, & Grid No.2

9-PIN MINIATURE TYPE

GENERAL DATA

Electrical:

Heater Characteristics and Ratings (*Design-Maximum Values*):

Voltage (AC or DC)	6.3 ± 0.6	volts
Current at heater volts = 6.3	0.300	amp

Peak heater-cathode voltage:

Heater negative with respect to cathode	200	max.	volts
---	-----	------	-------

Heater positive with respect to cathode	200 ^a	max.	volts
---	------------------	------	-------

Direct Interelectrode Capacitances:^b

Grid No.3 to plate (Each unit)	2.0	pf
--	-----	----

Grid No.1 to all other electrodes	6.0	pf
---	-----	----

Grid No.3 (Each unit) to all other electrodes	3.6	pf
---	-----	----

Plate (Each unit) to all other electrodes	3.0	pf
---	-----	----

Grid No.3 (Unit No.1) to grid No.3 (Unit No.2)	0.015	max.	pf
--	-------	------	----

Characteristics, Class A₁ Amplifier:*With one unit operating and plate and grid No.3 of other unit connected to ground*

Plate Voltage	100	100	volts
-------------------------	-----	-----	-------

Grid-No.3 Voltage	0	0	volts
-----------------------------	---	---	-------

Grid-No.2 Voltage	67.5	67.5	volts
-----------------------------	------	------	-------

Grid-No.1 Voltage	0	^c	volts
-----------------------------	---	--------------	-------

Grid-No.3-to-Plate Transconductance	-	450	μmhos
---	---	-----	-------

Grid-No.1-to-Plate Transconductance	1100	-	μmhos
---	------	---	-------

Plate Current	-	2	ma
-------------------------	---	---	----

Grid-No.3 Voltage (Approx.) for plate μa = 100	-	-3.5	volts ←
--	---	------	---------

Grid-No.1 Voltage (Approx.) for plate μa = 100	-	-2.3	volts
--	---	------	-------

With both units operating

Plate Voltage (Each unit)	100	100	volts
-------------------------------------	-----	-----	-------

Grid-No.3 Voltage (Each unit)	-10	0	volts
---	-----	---	-------

Grid-No.2 Voltage	67.5	67.5	volts
-----------------------------	------	------	-------

Grid-No.1 Voltage	^c	^c	volts
-----------------------------	--------------	--------------	-------

Plate Current (Each unit)	-	2	ma
-------------------------------------	---	---	----

Grid-No.2 Current	7	4.4	ma
-----------------------------	---	-----	----

Cathode Current	7.1	8.5	ma
---------------------------	-----	-----	----

← Indicates a change.



6HS8

Mechanical:

Operating Position	Any
Type of Cathode	Coated Unipotential
Maximum Overall Length	2-5/8"
Maximum Seated Length	2-3/8"
Length, Base Seat to Bulb Top (Excluding tip)	2" ± 3/32"
Diameter	0.750" to 0.875"
Dimensional Outline	See <i>General Section</i>
Bulb	T6-1/2
Base	Small-Button Noval 9-Pin (JEDEC No. E9-1)

→ Basing Designation for BOTTOM VIEW, 9FG

- Pin 1 - Cathode
- Pin 2 - Grid No.2,
Internal
Shield
- Pin 3 - Plate of
Unit No.2
- Pin 4 - Heater
- Pin 5 - Heater

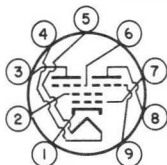

- Pin 6 - Grid No.3 of
Unit No.2
- Pin 7 - Grid No.1
- Pin 8 - Plate of
Unit No.1
- Pin 9 - Grid No.3 of
Unit No.1

AMPLIFIER — Class A₁

Maximum Ratings, Design-Maximum Values:

PLATE VOLTAGE (Each unit)	300 max.	volts
GRID-No.3 (SUPPRESSOR-GRID) VOLTAGE (Each unit):		
Peak positive value	50 max.	volts
DC negative value	50 max.	volts
DC positive value	3 max.	volts
GRID-No.2 (SCREEN-GRID) VOLTAGE	150 max.	volts
GRID-No.1 (CONTROL-GRID) VOLTAGE:		
Negative-bias value	50 max.	volts
CATHODE CURRENT	12 max.	ma
GRID-No.2 INPUT	0.75 max.	watt
PLATE DISSIPATION (Each unit)	1.1 max.	watts

Maximum Circuit Values:

Grid-No.3-Circuit Resistance (Each unit).	0.5 max.	megohm
Grid-No.1-Circuit Resistance.	0.5 max.	megohm

^a The dc component must not exceed 100 volts.

^b without external shield.

^c Adjusted to give a dc grid-No.1 current of 100 microamperes.

→ Indicates a change.



AVERAGE PLATE CHARACTERISTICS

Each Unit

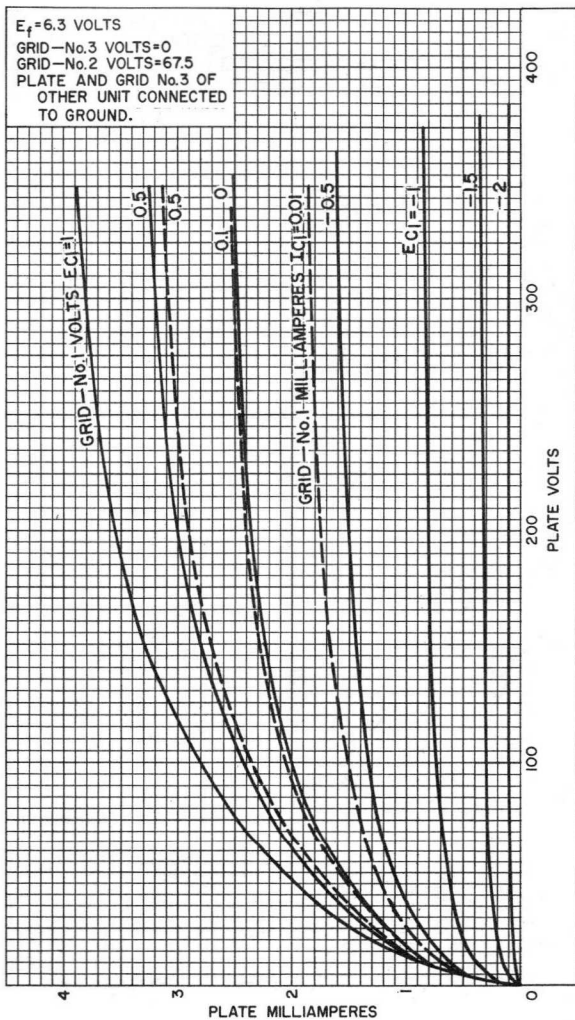

92CM-11099



6HS8

AVERAGE PLATE CHARACTERISTICS Each Unit

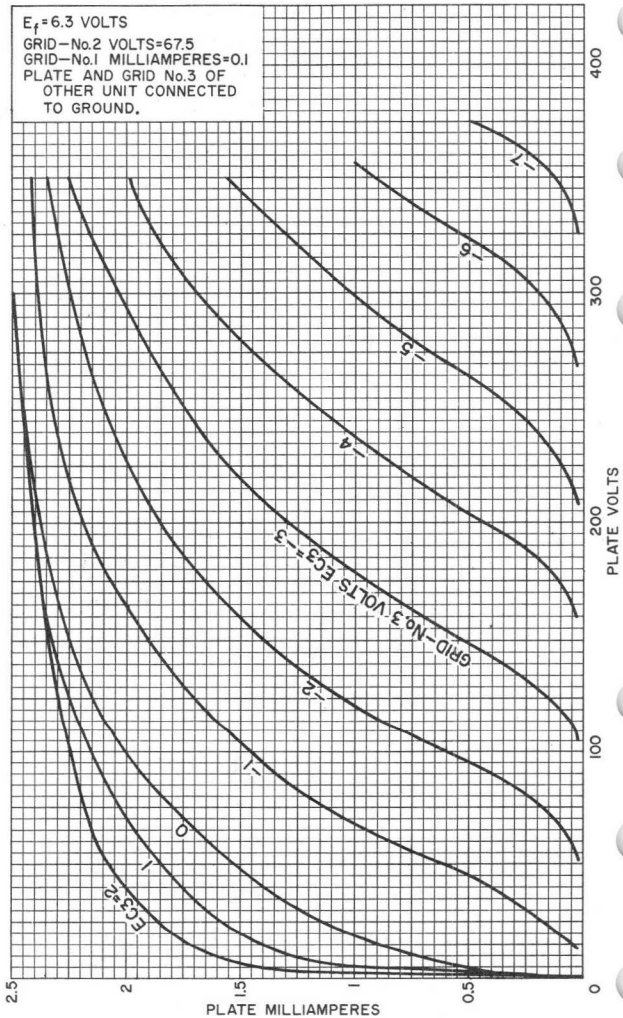

92CM-11102



AVERAGE CHARACTERISTICS Each Unit

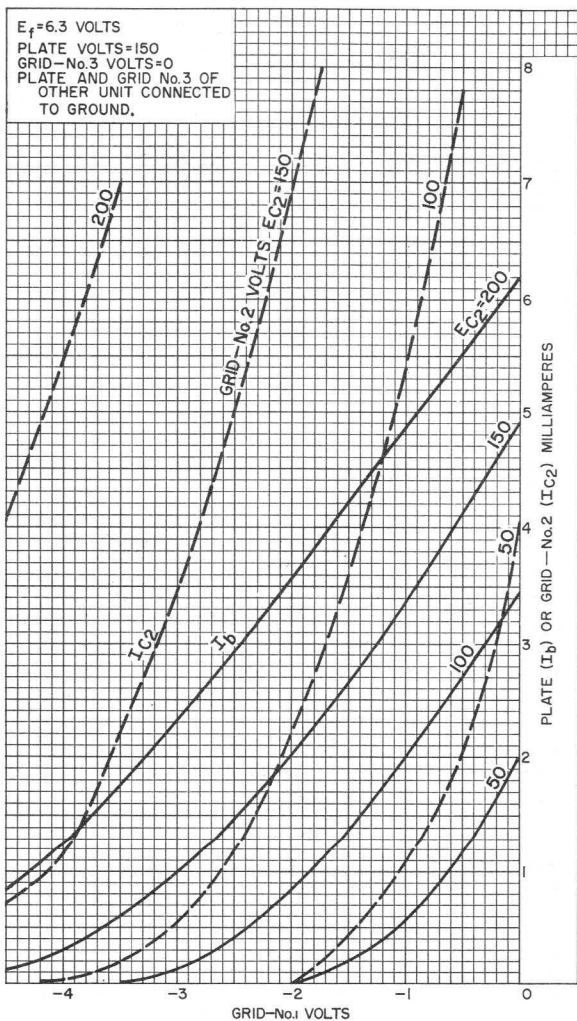

92CM—11104



6HS8

AVERAGE CHARACTERISTICS Each Unit

$E_f = 6.3$ VOLTS
 PLATE VOLTS = 150
 GRID-No.1 MILLIAMPERES = 0.1
 PLATE AND GRID No.3 OF
 OTHER UNIT CONNECTED
 TO GROUND.

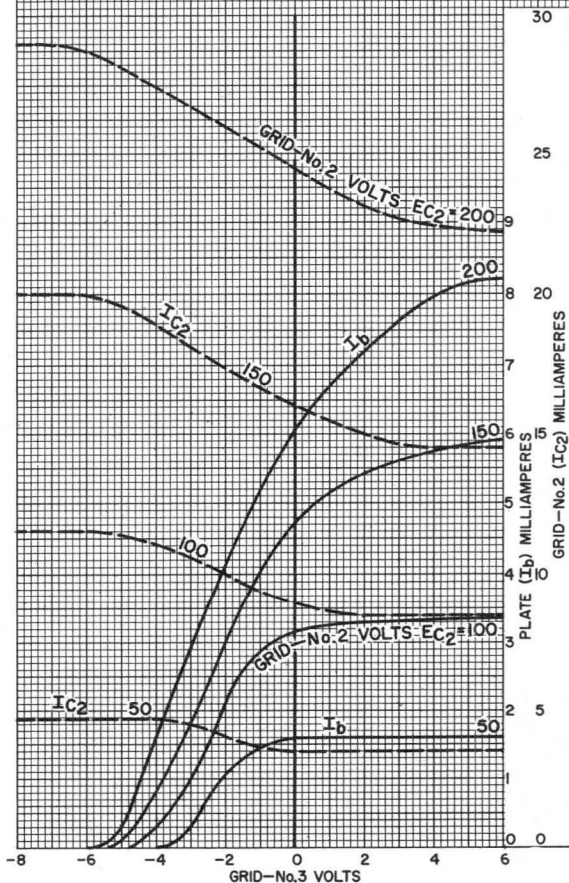

92CM-11105



Sharp-Cutoff Pentode

With Two Independent Control Grids

7-PIN MINIATURE TYPE

With Heater Having Controlled Warm-Up Time

GENERAL DATA

Electrical:Heater Characteristics and Ratings (*Design-Maximum Values*):

Voltage (AC or DC)	6.3 ^a	6.3 ± 0.6	volts
Current	0.450 ± 0.030	0.450 ^b	amp
Warm-up time (Average)	11	—	sec
Peak heater-cathode voltage:			
Heater negative with respect to cathode	200	max.	volts
Heater positive with respect to cathode	200 ^c	max.	volts

Direct Interelectrode Capacitances

(Approx):^d

Grid No.1 to plate	0.023	pf
Grid No.1 to cathode & internal shield, grid No.3, grid No.2 & internal shield, and heater	8.2	pf
Grid No.1 to grid No.3	0.09	pf
Grid No.3 to plate	1.6	pf
Grid No.3 to cathode & internal shield, plate, grid No.2 & internal shield, grid No.1, and heater	7.2	pf

Characteristics, Class A₁ Amplifier:

Plate Supply Voltage	150	volts
Grid-No.3 Supply Voltage	0	volts
Grid-No.2 Supply Voltage	100	volts
Grid-No.1 Supply Voltage	0	volts
Cathode Resistor	180	ohms
Plate Resistance (Approx.)	0.11	megohm
Transconductance, Grid No.1 to Plate	3400	μmhos
Transconductance, Grid No.3 to Plate	600	μmhos
Plate Current	3.2	ma
Grid-No.2 Current	3.2	ma
Grid-No.1 Supply Voltage (Approx.) for plate $\mu a = 20$	-4.5	volts
Grid-No.3 Supply Voltage (Approx.) for plate $\mu a = 20$	-7	volts

Mechanical:

Operating Position	Any
Type of Cathode	Coated Unipotential
Maximum Overall Length	2-1/8"
Maximum Seated Length	1-7/8"
Length, Base Seat to Bulb Top (Excluding tip)	1-1/2" ± 3/32"
Diameter	0.650" to 0.750"



6HZ6

Bulb. T5-1/2
 Base. Small-Button Miniature 7-Pin (JEDEC No.E7-1)
 Basing Designation For BOTTOM VIEW. 7EN

Pin 1 - Grid No.1
 Pin 2 - Cathode,
 Internal
 Shield
 Pin 3 - Heater

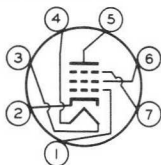

Pin 4 - Heater
 Pin 5 - Plate
 Pin 6 - Grid No.2,
 Internal
 Shield
 Pin 7 - Grid No.3

FM SOUND-DETECTOR SERVICE

Maximum Ratings, Design-Maximum Values:

PLATE VOLTAGE	300 max.	volts
GRID-No.3 (CONTROL-GRID) VOLTAGE:		
Negative value (DC and peak).	100 max.	volts
Positive value (DC and peak).	25 max.	volts
GRID-No.2 (SCREEN-GRID) SUPPLY VOLTAGE. . .	300 max.	volts
GRID-No.2 VOLTAGE	See <i>Grid-No.2 Input Rating Chart</i> at front of Receiving Tube Section	
GRID-No.1 (CONTROL-GRID) VOLTAGE:		
Negative-bias value	50 max.	volts
Positive-bias value	0 max.	volts
GRID-No.3 INPUT	0.1 max.	watt
GRID-No.2 INPUT:		
For grid-No.2 voltages up to 150 volts	1 max.	watt
For grid-No.2 voltages between 150 volts and 300 volts	See <i>Grid-No.2 Input Rating Chart</i> at front of Receiving Tube Section	
PLATE DISSIPATION	1.7 max.	watts

Maximum Circuit Values:

Grid-No.3-Circuit Resistance.	0.68 max.	megohm
Grid-No.1-Circuit Resistance:		
For fixed-bias operation.	0.22 max.	megohm
For cathode-bias operation.	0.47 max.	megohm

- ^a At heater amperes = 0.450.
- ^b At heater volts = 6.3.
- ^c The dc component must not exceed 100 volts.
- ^d Without external shield.



AVERAGE CHARACTERISTICS

$E_f = 6.3$ VOLTS
 PLATE VOLTS = 150
 GRID-NO. 2 VOLTS = 100

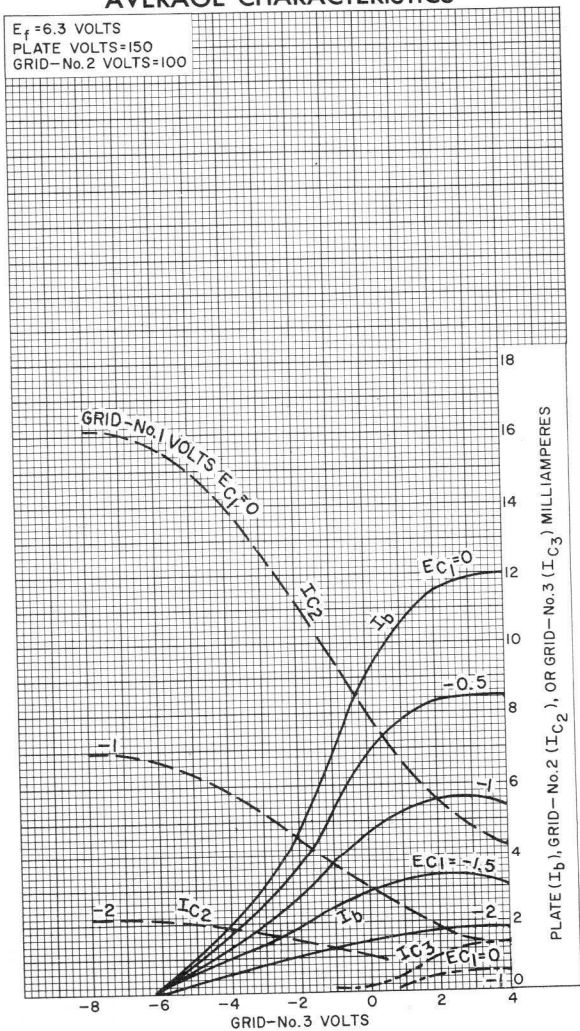

92CM-11789



6HZ6

AVERAGE GRID-No.1 CHARACTERISTIC

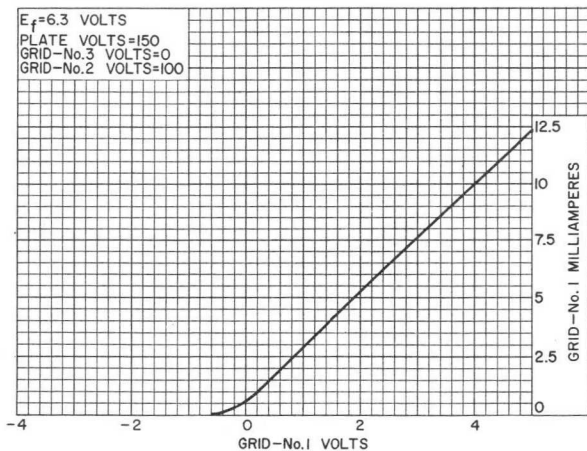

92CS-11004



AVERAGE CHARACTERISTICS

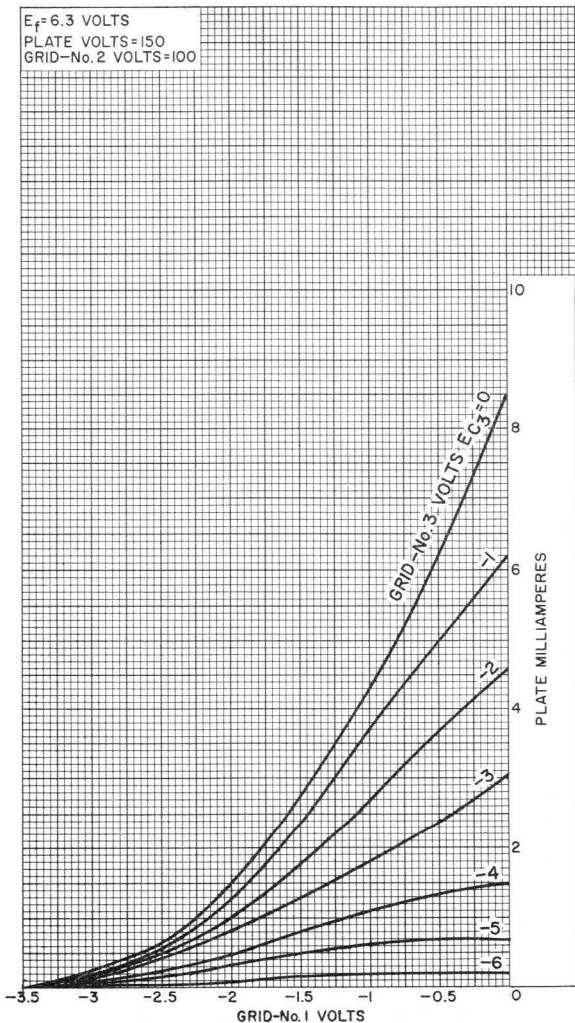

92CM-11788



6HZ6

AVERAGE CHARACTERISTICS

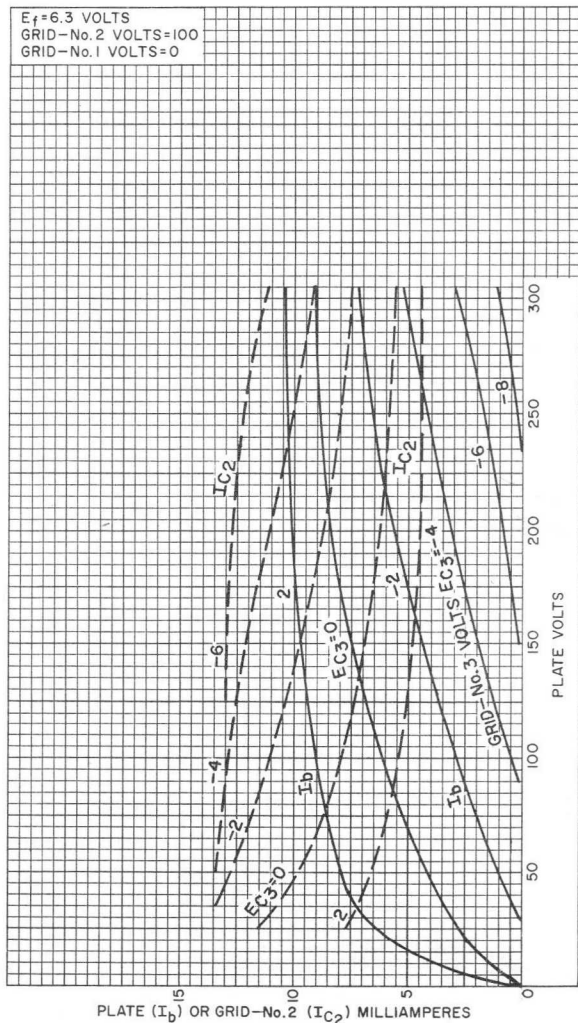

92CM-11793



AVERAGE CHARACTERISTICS

$E_f = 6.3$ VOLTS
 PLATE VOLTS = 150
 GRID-No.2 VOLTS = 100

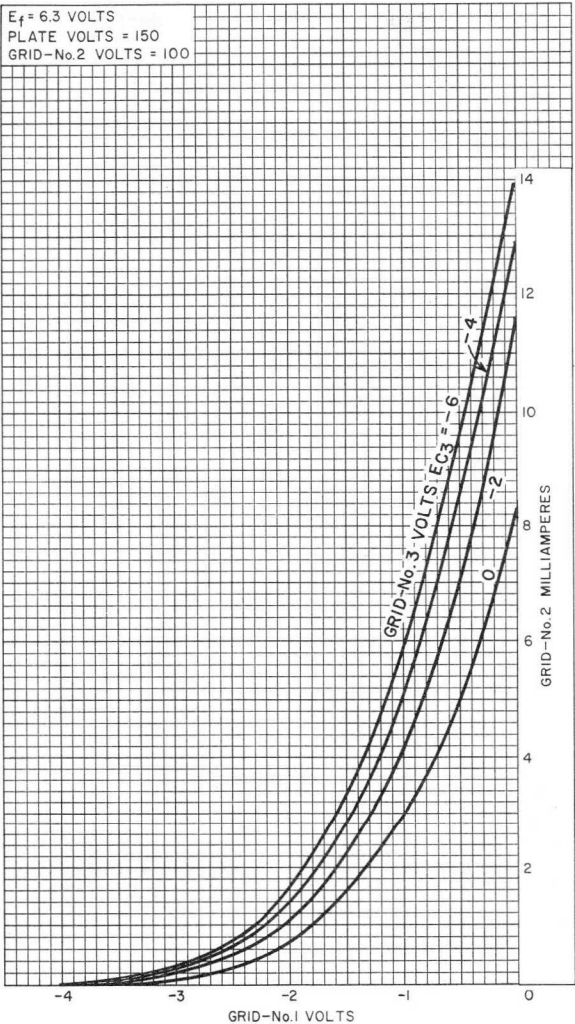

92CM-11791



6HZ6

AVERAGE CHARACTERISTICS

$E_f = 6.3$ VOLTS
GRID-NO.3 VOLTS=0
GRID-NO.2 VOLTS=100

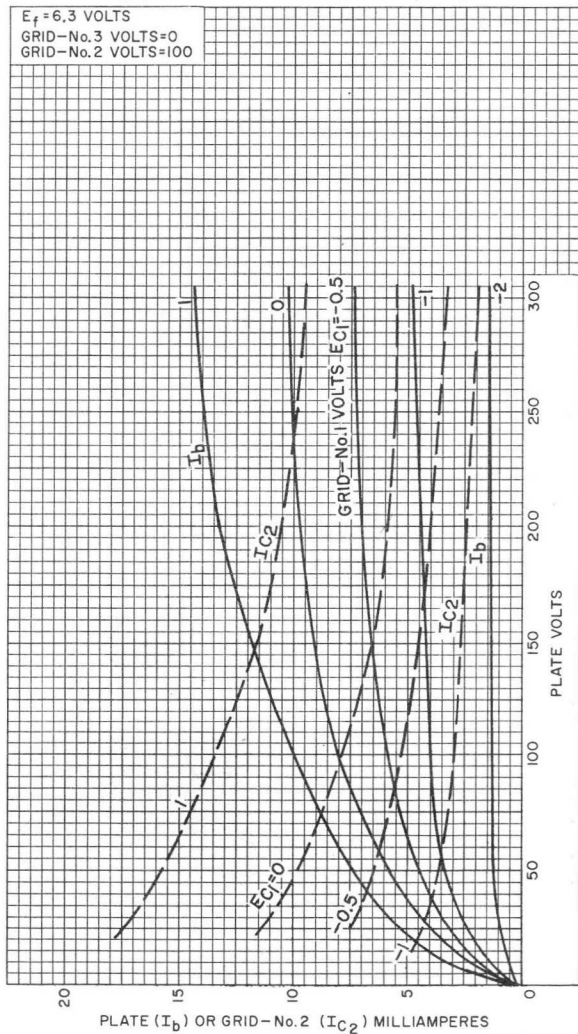

92CM-11792



Medium-Mu Twin Triode

7-PIN MINIATURE TYPE

With Heater Having Controlled Warm-Up Time

GENERAL DATA

Electrical:

Heater, for Unipotential Cathode:

Voltage (AC or DC)	6.3	volts
Current	0.45 ± 6%	amp
Warm-up time (Average)	11	sec

Direct Interelectrode Capacitances (Approx.):

	Without External Shield	With External Shield ^a	
<i>Unit No. 1</i>			
Grid to plate	1.6	1.5	μμf
Grid to cathode and heater . . .	2.2	2.6	μμf
Plate to cathode and heater . . .	0.4	1.6	μμf
<i>Unit No. 2</i>			
Grid to plate	1.6	1.5	μμf
Grid to cathode and heater . . .	2.2	2.6	μμf
Plate to cathode and heater . . .	0.4	1	μμf

Characteristics, Class A₁ Amplifier (Each Unit):

Plate Supply Voltage	100	volts
Cathode Resistor ^b	50 ^c	ohms
Amplification Factor	38	
Plate Resistance (Approx.)	7100	ohms
Transconductance	5300	μmhos
Plate Current	8.5	ma

Mechanical:

Operating Position	Any
Maximum Overall Length	2-1/8"
Maximum Seated Length	1-7/8"
Length, Base Seat to Bulb Top (Excluding tip) . . .	1-1/2" ± 3/32"
Diameter	0.650" to 0.750"
Dimensional Outline	See <i>General Section</i>
Bulb	T5-1/2
Base	Small-Button Miniature 7-Pin (JEDEC No. E7-1)
Basing Designation for BOTTOM VIEW7BF

Pin 1 - Plate of
Unit No. 2
Pin 2 - Plate of
Unit No. 1
Pin 3 - Heater
Pin 4 - Heater

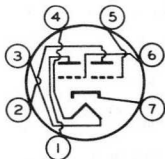

Pin 5 - Grid of
Unit No. 1
Pin 6 - Grid of
Unit No. 2
Pin 7 - Cathode



6J6A

AMPLIFIER — Class A₁

Values are for Each Unit

Maximum Ratings, Design-Center Values:

PLATE VOLTAGE	300 max.	volts
GRID VOLTAGE:		
Positive-bias value	0 max.	volts
PLATE DISSIPATION	1.5 max.	watts
PEAK HEATER-CATHODE VOLTAGE:		
Heater negative with respect to cathode.	100 max.	volts
Heater positive with respect to cathode.	100 max.	volts

Maximum Circuit Values:

Grid-Circuit Resistance:		
For cathode-bias operation	0.5 max.	megohm

RF POWER AMPLIFIER & OSCILLATOR — Class C Telegraphy

Key-down conditions per tube without modulation

Values are for Each Unit

Maximum Ratings, Design-Center Values:

DC PLATE VOLTAGE	300 max.	volts
DC GRID VOLTAGE:		
Negative-bias value	40 max.	volts
Positive-bias value	0 max.	volts
DC PLATE CURRENT	15 max.	ma
DC GRID CURRENT	8 max.	ma
DC PLATE INPUT	4.5 max.	watts
PLATE DISSIPATION	1.5 max.	watts
PEAK HEATER-CATHODE VOLTAGE:		
Heater negative with respect to cathode.	100 max.	volts
Heater positive with respect to cathode.	100 max.	volts

Typical Push-Pull Operation at Frequencies up to 50 Mc:^d

Values are for Both Units

DC Plate Voltage	150	volts
DC Grid Voltage:		
From a fixed supply of	-10	volts
From a grid resistor of	625	ohms
From a cathode resistor of	220	ohms
DC Plate Current	30	ma
DC Grid Current (Approx.) ^e	16	ma
Driving Power (Approx.) ^e	0.35	watt
Useful Power Output (Approx.)	3.5	watts

^a With external shield JEDEC No.316 connected to cathode.

^b Fixed-bias operation is not recommended.

^c Value is for both units operating at the specified conditions.

^d Approximately 1 watt can be obtained when the 6J6A is used at 250 Mc as a push-pull oscillator with a plate voltage of 150 volts, with maximum-rated plate dissipation, and with a grid resistor of 2000 ohms common to both units

^e For effect of load resistance on grid current and driving power, refer to *TUBE RATINGS—Grid Current and Driving Power* in the General Section.



AVERAGE CHARACTERISTICS Each Unit

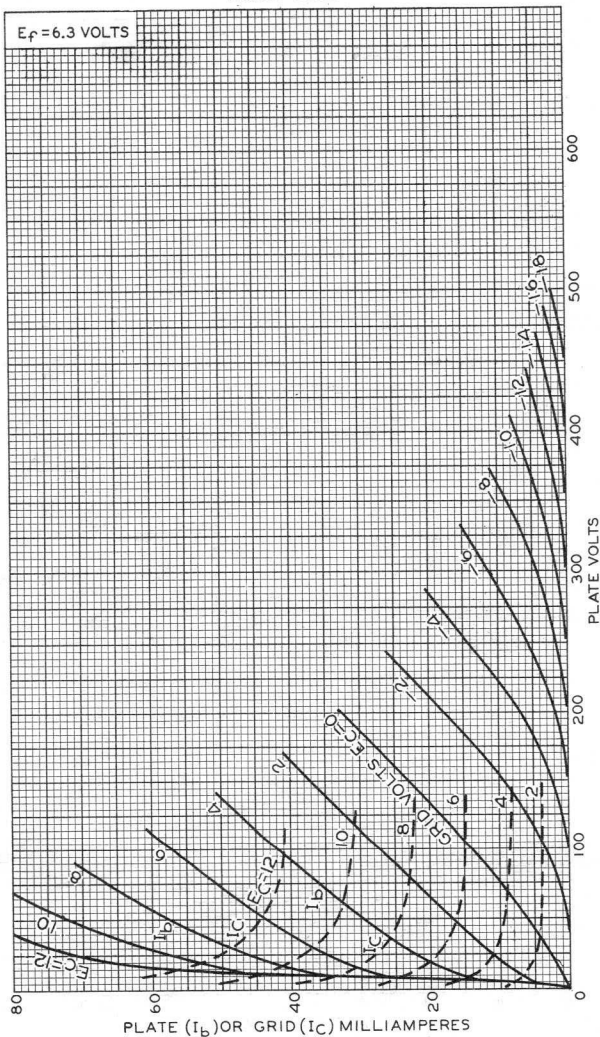

92CM-6403RI



6J6A

AVERAGE PLATE CHARACTERISTICS Each Unit

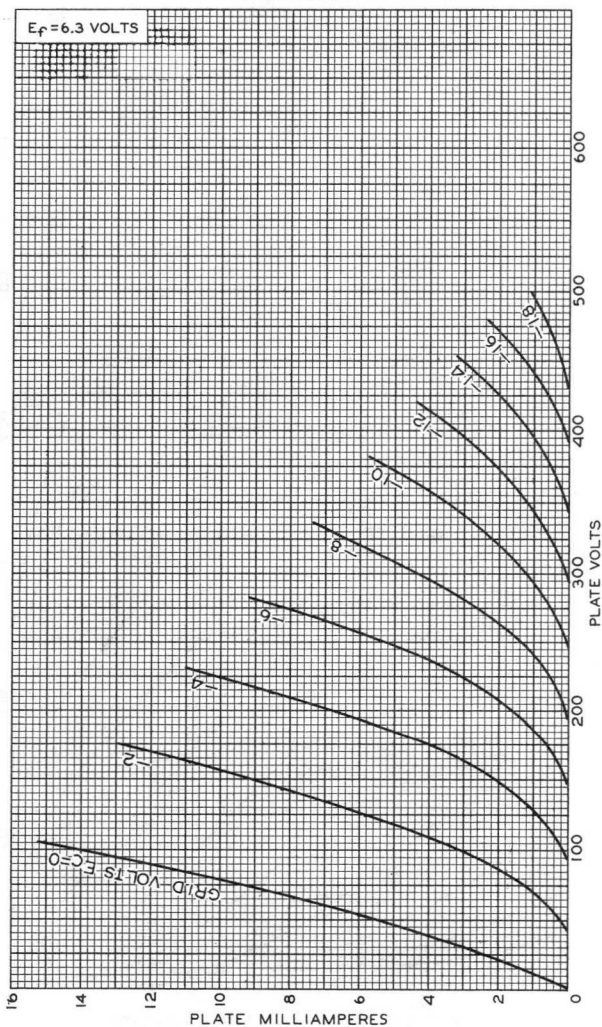

92CM-6402RI

RADIO CORPORATION OF AMERICA
Electron Tube Division

Harrison, N. J.



AVERAGE CHARACTERISTICS Each Unit

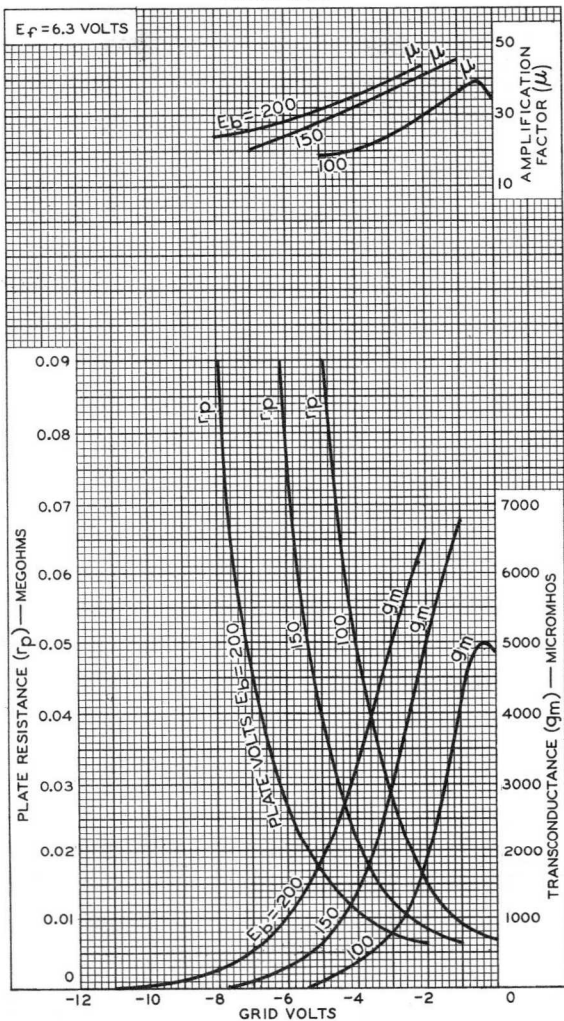

92CM-7672RI



0218

1953



Pentode— Beam Power Tube

For Combined Limiter, Quadrature-Grid Discriminator, and
Audio Power Output Applications in FM and TV Receivers

DUODECAR TYPE

Electrical:

Heater Characteristics and Ratings:

Voltage (AC or DC)	6.3 ± 0.6 volts
Current at heater volts = 6.3	0.950 amp
Peak heater-cathode voltage:	
Heater negative with respect to cathode	200 max. volts
Heater positive with respect to cathode	200 ^a max. volts

Direct Interelectrode Capacitances:^b

Beam Power Unit:

Grid No.1 to plate	0.2	pf
Input: G_{1B} to ($K_B + G_{3B}, G_{2B}, H$)	11	pf
Output: P_B to ($K_B + G_{3B}, G_{2B}, H$)	7.0	pf

Pentode Unit:

Grid No.1 to plate	0.01	pf
G_{1P} to ($K_P + IS, P_P, G_{3P}, G_{2P}, H$)	4.0	pf
G_{3P} to ($K_P + IS, P_P, G_{2P}, G_{1P}, H$)	3.2	pf

Mechanical:

Operating Position	Any
Types of Cathodes	Coated Unipotential
Maximum Overall Length	2.375"
Seated Length	1.750" to 2.000"
Diameter	1.062" to 1.188"
Dimensional Outline (JEDEC 9-58)	See General Section
Bulb	T9
Base	Small-Button Duodecar 12-Pin (JEDEC E12-70)
Basing Designation for BOTTOM VIEW	12BT

- Pin 1 - Heater
- Pin 2 - Beam Power Grid No.2
- Pin 3 - Beam Power Cathode,
Beam Power Grid No.3
- Pin 4 - Pentode Plate
- Pin 5 - Pentode Grid No.3
- Pin 6 - Pentode Grid No.2
- Pin 7 - Pentode Grid No.1
- Pin 8 - Pentode Cathode,
Internal Shields
- Pin 9 - Beam Power Plate
- Pin 10 - No Internal Connection
- Pin 11 - Beam Power Grid No.1
- Pin 12 - Heater

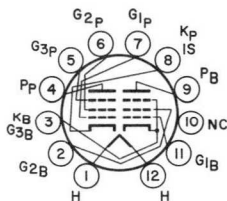

PENTODE UNIT — LIMITER & DISCRIMINATOR SERVICE

Maximum Ratings, *Design-Maximum Values:*

Plate Supply Voltage.	330	volts
Grid-No.3 (Quadrature-Grid) Voltage	c	
Grid-No.2 (Accelerator-Grid) Voltage.	110	volts
Grid-No.1 (Limiter-Grid) Voltage:		
Positive-peak value	60	volts
Cathode Current	13	ma

Typical Operation:

Input-Signal

<i>Center Frequency</i>	4.5	10.7	10.7	Mc
Plate Supply Voltage.	270	85	285	volts
Plate Voltage	62	121	122	volts
Grid-No.3 Voltage	c	c	c	c
Grid-No.2 Voltage	100	55	100	volts
Cathode-Circuit				
Resistance ^d	200-400	200-400	200-400	ohms
Peak AF Output Voltage.	16.8	6	16.6	volts
Minimum Grid-No.1				
Signal Voltage (RMS)				
for AM rejection ^d	2	1.25	2	volts
Minimum Grid-No.1				
Signal Voltage (RMS)				
for limiting action ^e	1.25	1.25	1.25	volts
Plate Current	0.44	0.25	0.49	ma
Grid-No.2 Current	10	4.1	9.8	ma
Plate Load Resistor	0.33	0.085	0.33	megohm
Linearity Resistor.	1000	470	1500	ohms
Integrating Capacitor	0.001	0.002	0.001	μ f
Coupling Capacitor.	0.25	0.25	0.01	μ f
Frequency Deviation	± 25	± 75	± 75	kc
AM Rejection:				
For grid-No.1 signal				
volts (RMS) = 2	25	31	20	db
For grid-No.1 signal				
volts (RMS) = 3	30	30	29	db
Total Harmonic				
Distortion.	1.8	2	1.6	%

BEAM POWER UNIT — AMPLIFIER — Class A₁Maximum Ratings, *Design-Maximum Values:*

Plate Voltage	275	volts
Grid-No.2 (Screen-Grid) Voltage.	275	volts
Plate Dissipation.	10	watts
Grid-No.2 Input.	2	watts

Typical Operation and Characteristics:

Plate Voltage.	250	volts
Grid-No.2 Voltage.	250	volts
Grid-No.1 (Control-Grid) Voltage	-8	volts
Peak AF Grid-No.1 Voltage.	8	volts

Zero-Signal Plate Current.	35	ma
Max.-Signal Plate Current.	39	ma
Zero-Signal Grid No.2 Current.	2.5	ma
Max.-Signal Grid No.2 Current.	7	ma
Plate Resistance (Approx.)	0.1	megohm
Transconductance	6500	μ mhos
Load Resistance.	5000	ohms
Total Harmonic Distortion.	10	%
Max.-Signal Power Output	4.2	watts

Maximum Circuit Values:

Grid-No.1-Circuit Resistance:

For fixed-bias operation	0.25	megohm
For cathode-bias operation	0.5	megohm

a The dc component must not exceed 100 volts.

b Without external shield.

c For proper operation of the pentode unit of the type shown in the accompanying Typical Quadrature-Grid-FM Detector Circuit, the Q of the tuned circuit (L_1 , C_6) should be sufficiently high to develop a 4-volt rms signal at the quadrature grid when a 2-volt rms signal at the center frequency is applied to grid No.1.

It is recommended that L_1 be shunted by a capacitance of at least 10 μ mf. This capacitance may be composed of tube capacitance, stray capacitance, the distributed capacitance of L_1 , and a fixed capacitor.

d The cathode-circuit resistance should be adjusted for maximum AM rejection at the AF output of the circuit at the specified grid-No.1 signal voltage. AM rejection is measured with an applied signal containing 30 per cent amplitude modulation and 30 per cent frequency modulation.

e At signal levels above specified value, limiting is within ± 3 decibels.

OPERATING CONSIDERATIONS FOR PENTODE UNIT

To insure proper phasing of the signal voltage developed at the quadrature grid, the components of the quadrature-grid circuit should be shielded from those of the control-grid circuit.

To obtain a symmetrical discriminator-response curve, the plate currents for no input signal and for unmodulated input signal should be equal. To assure this equality, it is necessary that the plate voltage and grid-No.2 voltage have the proper values.

The proper plate voltage for any grid-No.2 voltage may be determined from the accompanying *Operating Characteristics, Pentode Unit* curve. This curve may also be used to determine the average dynamic plate current for any combination of grid-No.2 voltage and plate voltage.



TYPICAL QUADRATURE-GRID-
FM-DETECTOR CIRCUIT

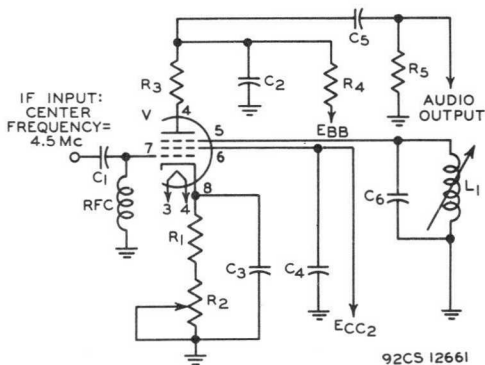

- C_1 : 100 μf
 C_2 : Integrating capacitor,
 0.001 μf
 C_3, C_4 : 0.01 μf
 C_5 : 0.25 μf
 C_6 : 10 μf ^c
 L_1 : c
 R_1 : 200 ohms
 R_2 : Cathode-bias
 potentiometer, 200 ohms

- R_3 : Linearity resistor,
 1000 ohms
 R_4 : Plate-load resistor,
 0.33 megohm
 R_5 : 0.47 megohm
 V : Pentode Unit of
 Electron-tube-type
 6J10

^c For footnote see end of data.

Information furnished by RCA is believed to be accurate and reliable. However, no responsibility is assumed by RCA for its use; nor for any infringements of patents or other rights of third parties which may result from its use. No license is granted by implication or otherwise under any patent or patent rights of RCA.

AVERAGE PLATE CHARACTERISTICS

Pentode Unit

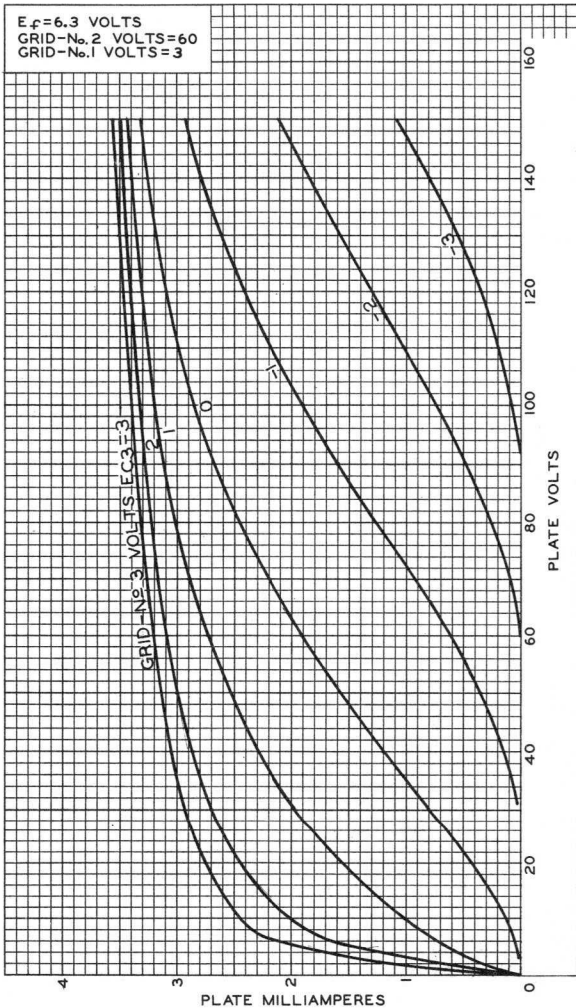

92CM-10319



AVERAGE CHARACTERISTICS Pentode Unit

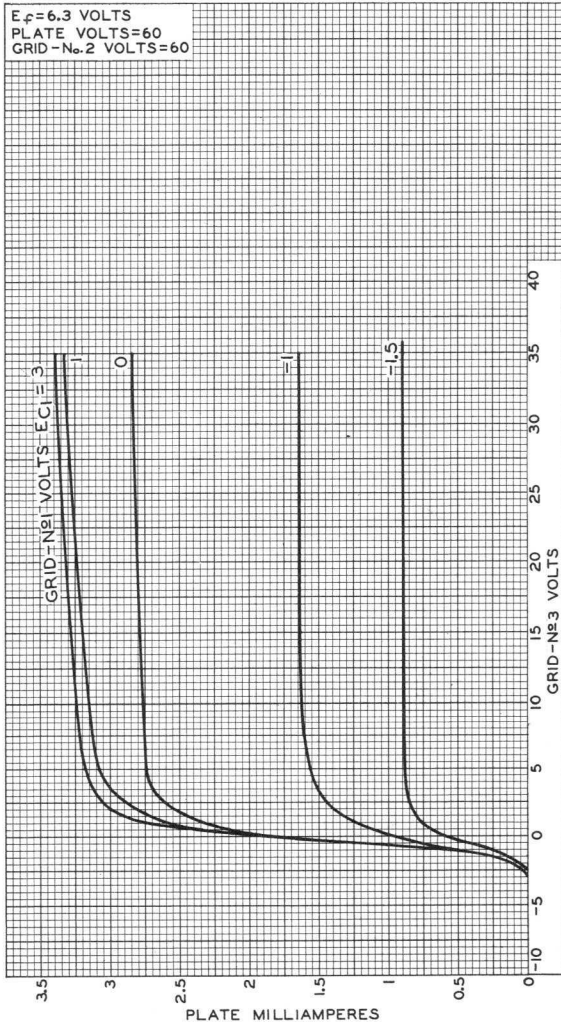

92CM-10320



AVERAGE CHARACTERISTICS

Pentode Unit

$E_p = 6.3$ VOLTS
 PLATE VOLTS = 60
 GRID-No.2 VOLTS = 60

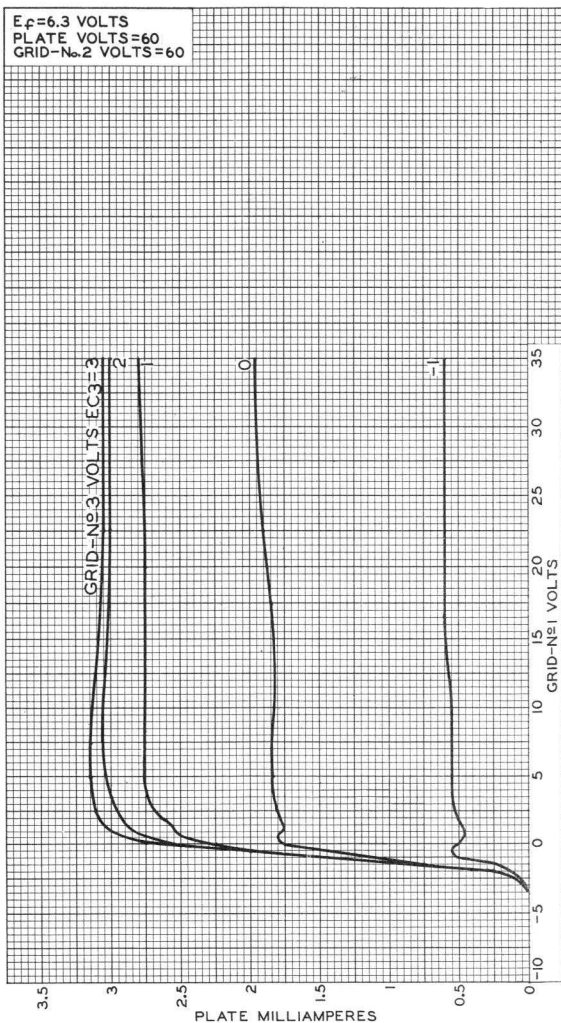

92CM-10322



OPERATION CHARACTERISTICS Pentode Unit

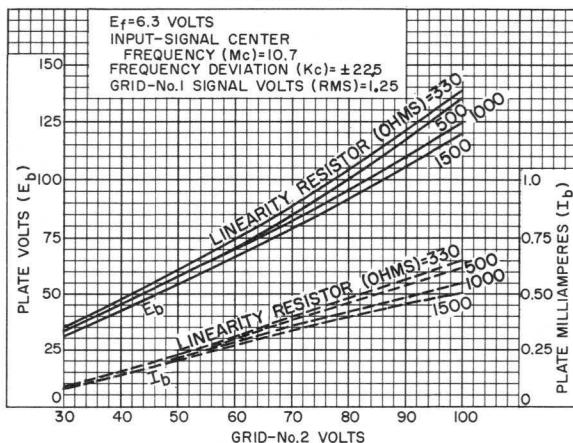

92CS-12662

OPERATION CHARACTERISTICS Beam Power Unit

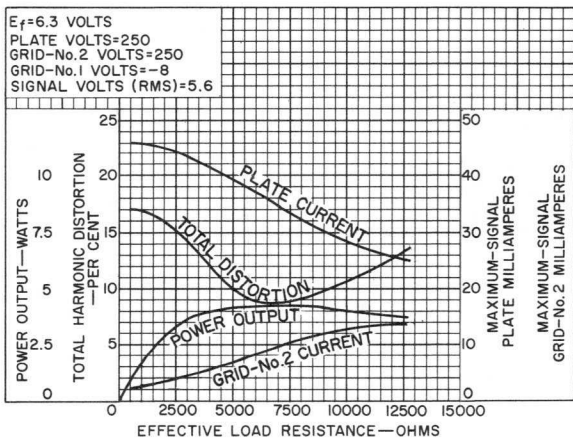

92CS-12663



AVERAGE CHARACTERISTICS

Beam Power Unit

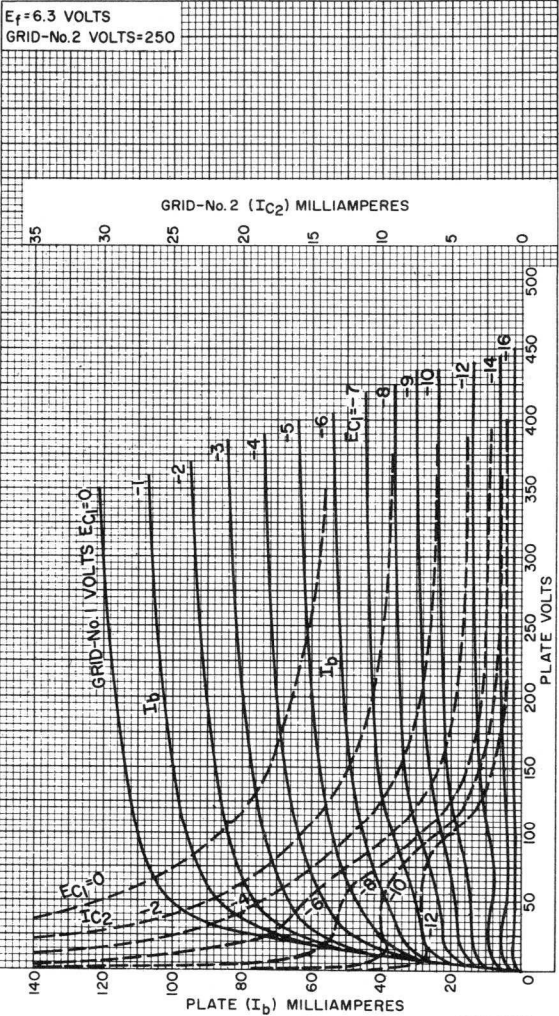

92CM-12669





6JB6A

Beam Power Tube

NOVAR TYPE

SEPARATE GRID-NO.3 BASE-PIN TERMINAL FOR "SNIVETS" CONTROL^a

For Horizontal-Deflection-Amplifier
Service in Black-and-White TV Receivers

Electrical:

Heater Characteristics and Ratings:

Voltage (AC or DC)	6.3 ± 0.6	volts
Current at heater volts = 6.3	1.200	amp
Peak heater-cathode voltage:		
Heater negative with respect to cathode	200	max. volts
Heater positive with respect to cathode	200 ^b	max. volts

Direct Interelectrode Capacitances (Approx.):^c

Grid No.1 to plate	0.2	pf
Input: G1 to (K+G3, G2, H)	15.0	pf
Output: P to (K+G3, G2, H)	6.0	pf

Mechanical:

Operating Position	Any
Type of Cathode	Coated Unipotential
Maximum Overall Length	3.505"
Seated Length	2.875" ± 3.125"
Diameter	1.438" ± 1.562"
Dimensional Outline	See General Section
Bulb	T12
Cap	Skirted Miniature (JEDEC No. C1-2 or C1-3)
Base	Large-Button Novar 9-Pin with Exhaust Tip (JEDEC No. E9-88)
Basing Designation for BOTTOM VIEW	9QL

- Pin 1-Grid No.2
- Pin 2-Grid No.1
- Pin 3-Cathode
- Pin 4-Heater
- Pin 5-Heater
- Pin 6-Grid No.1
- Pin 7-Grid No.2
- Pin 8-Grid No.3
- Pin 9-Do Not Use
- Cap-Plate

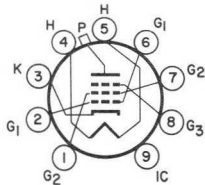

Characteristics, Class A₁ Amplifier:

	Triode Connection	Pentode Connection	
Plate Voltage	150	60	250 volts
Grid No.3	-	Connected to cathode at socket	
Grid-No.2 Voltage	150	150	150 volts
Grid-No.1 Voltage	-22.5	0	-22.5 volts
Amplification Factor	4.4	-	-
Plate Resistance (Approx.)	-	-	15000 ohms



6JB6A

	Triode Connection	Pentode Connection	
Transconductance	-	-	7100 μ mhos
Plate Current	-	390 ^d	70 ma
Grid-No.2 Current	-	32 ^d	2.1 ma
Grid-No.1 Voltage (Approx.) for plate current = 1 ma. . .	-	-	-42 volts

HORIZONTAL-DEFLECTION AMPLIFIER

Maximum Ratings, Design-Maximum Values:

For operation in a 525-line, 30-frame system^e

DC Plate-Supply Voltage	770 max.	volts
Peak Positive-Pulse Plate Voltage ^f	6500 max.	volts
Peak Negative-Pulse Plate Voltage	1500 max.	volts
DC Grid-No.3 Voltage ^a	70 max.	volts
DC Grid-No.2 (Screen-Grid) Voltage	220 max.	volts
DC Grid-No.1 (Control-Grid) Voltage	-55 max.	volts
Peak Negative-Pulse Grid-No.1 Voltage . . .	330 max.	volts
Cathode Current:		
Peak	550 max.	ma
Average	175 max.	ma
Grid-No.2 Input	3.5 max.	watts
Plate Dissipation ^g	17.5 max.	watts
Bulb Temperature (At hottest point on bulb surface). . . .	240 max.	°C

Maximum Circuit Values:

Grid-No.1-Circuit Resistance: For grid-resistor bias operation ^f	1 max.	megohm
--	--------	--------

^a A positive voltage may be applied to grid No.3 to reduce interference from "snivets" which may occur in television receivers. A typical value for this voltage is 30 volts.

^b The dc component must not exceed 100 volts.

^c without external shield.

^d This value can be measured by a method involving a recurrent wave form such that the plate dissipation, grid-No.2 input, and cathode current will be kept within ratings in order to prevent damage to the tube.

^e As described in "Standards of Good Engineering Practice Concerning Television Broadcast Stations", Federal Communications Commission.

^f This rating is applicable where the duration of the voltage pulse does not exceed 15 per cent of one horizontal scanning cycle. In a 525 line, 30-frame system, 15 per cent of one horizontal scanning cycle is 10 microseconds.

^g It is essential that the plate dissipation be limited in the event of loss of grid signal. For this purpose, some protective means such as a cathode resistor of suitable value should be employed.



AVERAGE CHARACTERISTICS

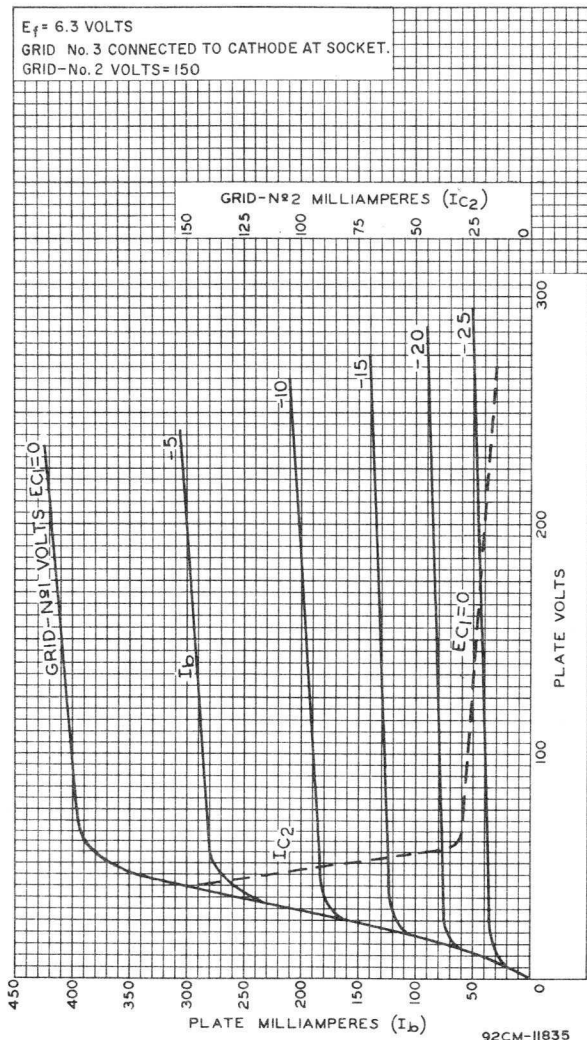



Sharp-Cutoff Pentode

9-PIN MINIATURE TYPE

FRAME-GRID CONSTRUCTION

DARK HEATER

*For Use in IF-Amplifier Stages of Color-
and Black-and-White TV Receivers*

ELECTRICAL CHARACTERISTICS

Bogey Values^a

Heater Voltage (AC or DC)	E_h	6.3	V
Heater Current	I_h	0.300	A
Direct Interelectrode Capacitances			
Without external shield			
Grid No.1 to plate	C_{g1-p}	0.019 max	pF
Input: G1 to (K, G3+IS, G2, H)	C_i	8.5	pF
Output: P to (K, G3+IS, G2, H)	C_o	3.0	pF

For the following characteristics, see Conditions

Plate Resistance (Approx.)	r_p	180	Ω
Transconductance	g_m	16000	μmho
DC Plate Current	I_b	14	mA
DC Grid-No.2 Current	I_{c2}	3.4	mA
Cutoff DC Grid-No.1 Voltage	$E_{c1(c)}$	-3	V

Plate $\mu\text{A} = 100$

Conditions

Heater Voltage	E_h	Bogey Value	V
DC Plate Supply Voltage	E_{bb}	125	V
Grid No.3	-	Connected to cathode at socket	
DC Grid-No.2 Supply Voltage	E_{cc2}	125	V
Cathode Resistor	R_k	56	Ω

MECHANICAL CHARACTERISTICS

Operating Position	Any
Type of Cathode	Coated Unipotential
Maximum Overall Length	2.187 in
Maximum Seated Length	1.937 in
Length, Base Seat to Bulb Top	1.469 to 1.656 in
Excluding tip	
Maximum Diameter	0.875 in
Dimensional Outline (JEDEC 6-2)	See <i>General Section</i>
Envelope	JEDEC T6-1/2
Base	Small-Button Noval 9-Pin (JEDEC E9-1)



6JC6A

TERMINAL DIAGRAM (Bottom View)

- Pin 1 - Cathode
- Pin 2 - Grid No.1
- Pin 3 - Cathode
- Pin 4 - Heater
- Pin 5 - Heater
- Pin 6 - No Internal Connection
- Pin 7 - Plate
- Pin 8 - Grid No.2
- Pin 9 - Grid No.3,
Internal Shield

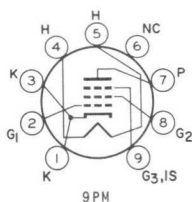

DESIGN-MAXIMUM RATINGS

For operation as a Class A₁ Amplifier Tube

DC Plate Voltage	E_b	330	V
Positive DC Grid-No.3 (Suppressor-Grid) Voltage	E_{c3}	0	V
DC Grid-No.2 (Screen-Grid) Supply Voltage	E_{cc2}	330	V
DC Grid-No.2 Voltage	E_{c2}	See Grid-No. 2	

Input Rating Chart

at front of Receiving Tube Section

DC Grid-No.1 (Control-Grid) Voltage Positive-bias value.	E_{c1}	0	V
Heater-Cathode Voltage Peak	e_{hkm}	±200	V
DC	E_{hk}	100	V
Heater Voltage (AC or DC).	E_h	5.7 to 6.9	V
Grid-No.2 Input For $E_{c2} \leq 165$ V.	P_{g2}	0.7	W
For $E_{c2} \geq 165$ V and ≤ 330 V.	-	See Grid-No. 2	

Input Rating Chart

at front of Receiving Tube Section

Plate Dissipation.	P_b	3.1	W
----------------------------	-------	-----	---

MAXIMUM CIRCUIT VALUES

Grid-No.1 Circuit Resistance	$R_{g1(ckt)}$		
For fixed-bias operation	-	0.25	MΩ
For cathode-bias operation	-	1	MΩ

^a Unless otherwise specified.



Typical Characteristics

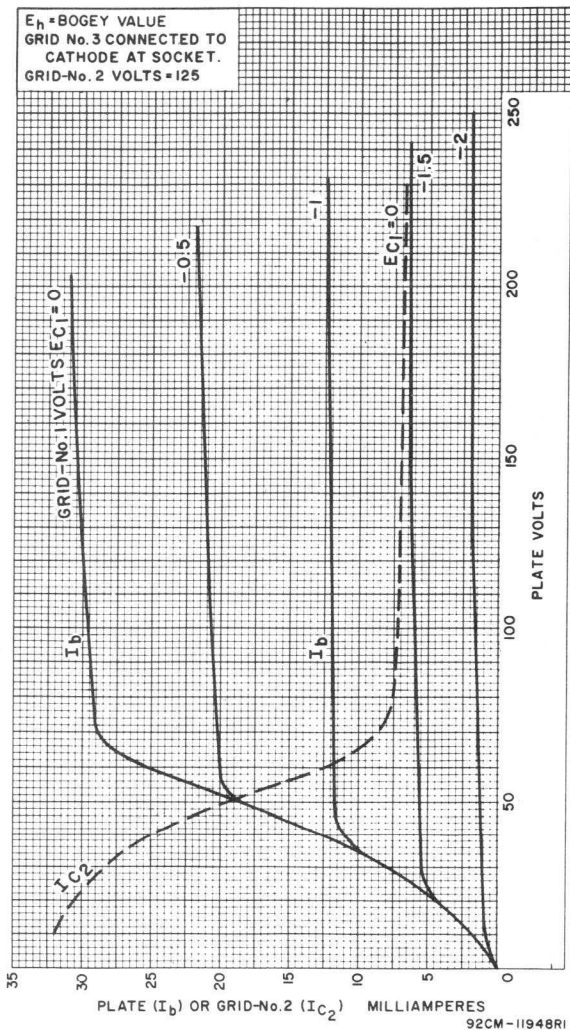

Typical Characteristics

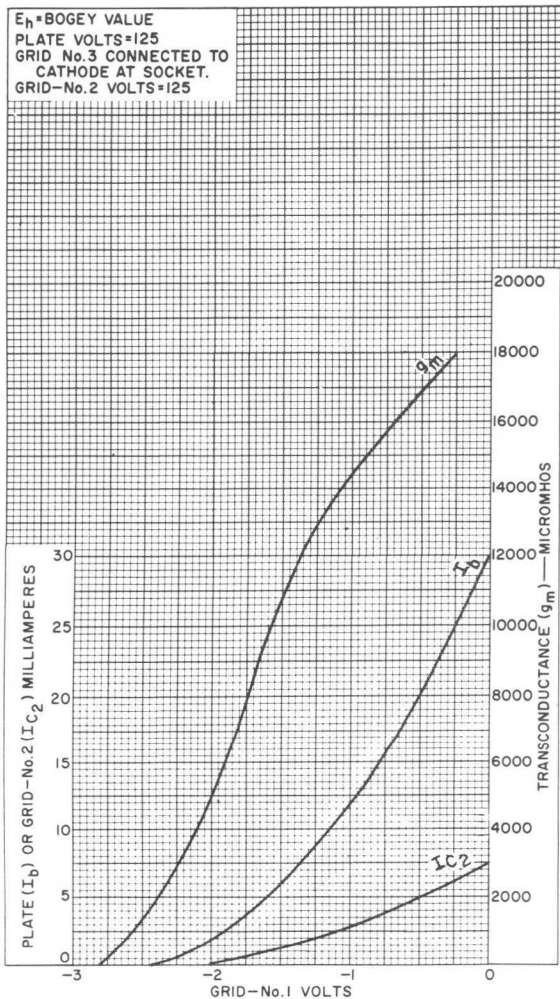

92CM - 11949R1



Medium-Mu Triode— Sharp-Cutoff Pentode

9-PIN MINIATURE TYPE

With Heater Having Controlled Warm-Up Time

GENERAL DATA

Electrical:Heater Characteristics and Ratings (*Design-Maximum Values*):

Voltage (AC or DC)	6.3 ^a	6.3 ± 0.6	volts
Current	0.450 ± 0.030	0.450 ^b	amp
Warm-up time (Average)	11	—	sec

Peak heater-cathode
voltage:Heater negative with
respect to cathode 200 max. voltsHeater positive with
respect to cathode 200^c max. volts

Direct Interelectrode Capacitances:

	<i>Without External Shield</i>	<i>With External Shield^d</i>	
<i>Triode Unit:</i>			
Grid to plate	1.3	1.2	μf
Grid to cathode and heater	2.8	3.2	μf
Plate to cathode and heater	0.44	0.9	μf
<i>Pentode Unit:</i>			
Grid No.1 to plate	0.038 max.	0.018 max.	μf
Grid No.1 to cathode & grid No.3 & internal shield, grid No.2, and heater	4.8	5.0	μf
Plate to cathode & grid No.3 & internal shield, grid No.2, and heater	0.9	1.6	μf
Pentode grid No.1 to triode plate	0.05 max.	0.036 max.	μf
Pentode plate to triode plate	0.075 max.	0.012 max.	μf
Heater to cathode	6.5	6.5 ^e	μf

Characteristics, Class A₁ Amplifier:

	<i>Triode Unit</i>	<i>Pentode Unit</i>		
Plate Voltage	125	100	125	volts
Grid-No.2 Voltage	—	70	125	volts
Grid-No.1 Voltage	-1	0	-1	volt
Amplification Factor	40	—	—	
Plate Resistance (Approx.)	6000	—	300000	ohms
Transconductance	6500	5700	5500	μmhos



6JC8

	<i>Triode Unit</i>	<i>Pentode Unit</i>	
Plate Current.	12	-	9 ma
Grid-No.2 Current.	-	-	2.2 ma
Grid-No.1 Voltage (Approx.) for plate $\mu = 20$	-7	-	6.5 volts

Mechanical:

Operating Position	Any		
Type of Cathode.	Coated Unipotential		
Maximum Overall Length	2-3/16"		
Maximum Seated Length.	1-15/16"		
Length, Base Seat to Bulb Top (Excluding tip)	1-9/16" \pm 3/32"		
Diameter	0.750" to 0.875"		
Dimensional Outline.	See <i>General Section</i>		
Bulb	T6-1/2		
Base	Small-Button Noval 9-Pin (JEDEC No. E9-1)		
Basing Designation for BOTTOM VIEW9PA		

- Pin 1 - Pentode
Grid No.3,
Cathode,
Internal
Shield
- Pin 2 - Pentode
Grid No.1
- Pin 3 - Pentode
Grid No.2
- Pin 4 - Heater

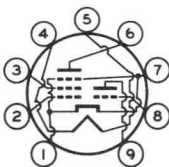

- Pin 5 - Heater
- Pin 6 - Pentode
Plate
- Pin 7 - Pentode
Grid No.3,
Cathode,
Internal
Shield
- Pin 8 - Triode Grid
- Pin 9 - Triode Plate

AMPLIFIER — Class A₁

Maximum Ratings, Design-Maximum Values:

	<i>Triode Unit</i>	<i>Pentode Unit</i>	
PLATE VOLTAGE.	275 max.	275 max.	volts
GRID-No.2 (SCREEN-GRID) SUPPLY VOLTAGE	-	275 max.	volts
GRID-No.2 VOLTAGE.	-	See <i>Grid-No.2 Input</i>	
<i>Rating Chart at front of Receiving Tube Section</i>			
GRID-No.1 (CONTROL-GRID) VOLTAGE:			
Positive-bias value.	0 max.	0 max.	volts
PLATE DISSIPATION.	1.7 max.	2.3 max.	watts
GRID-No.2 INPUT:			
For grid-No.2 voltages up to 137.5 volts.	-	0.45 max.	watt
For grid-No.2 voltages between 137.5 and 275 volts.	-	See <i>Grid-No.2 Input</i>	
<i>Rating Chart at front of Receiving Tube Section</i>			

Maximum Circuit Values:

	<i>Triode Unit</i>	<i>Pentode Unit</i>	
Grid-No.1-Circuit Resistance:			
For fixed-bias operation	-	0.1 max.	megohm
For cathode-bias operation.	-	0.5 max.	megohm



- a At heater amperes = 0.450.
- b At heater volts = 6.3.
- c The dc component must not exceed 100 volts.
- d With external shield JEDEC No.315 connected to pin 3 except as noted.
- e With external shield JEDEC No.315 connected to pin 6.



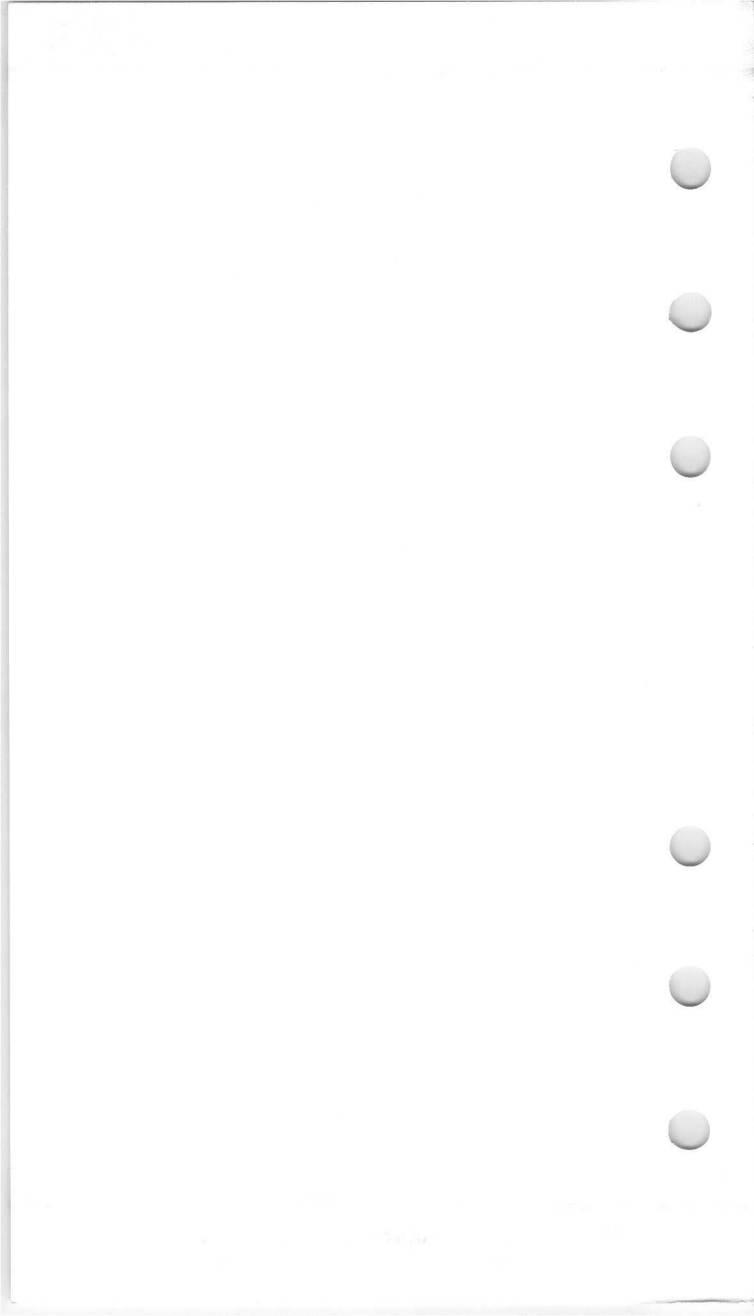

Sharp-Cutoff Pentode

9-PIN MINIATURE TYPE
FRAME-GRID CONSTRUCTION

For Use as High-Gain Intermediate-Frequency-Amplifier Tube in Television Receivers. No External Shield Required. Cutoff Characteristic Approaching Semiremote.

GENERAL DATA

Electrical:

Heater Characteristics and Ratings:

Voltage (AC or DC) 6.3 ± 0.6 volts
Current at heater volts = 6.3 0.300 amp

Peak heater-cathode voltage:

Heater negative with respect to cathode 200 max. volts

Heater positive with respect to cathode 200^a max. volts

Direct Interelectrode Capacitances:^b

Grid No.1 to plate 0.019 max. pf

Grid No.1 to cathode, grid No.3 & internal shield, grid No.2, and heater 8.2 pf

Plate to cathode, grid No.3 & internal shield, grid No.2, and heater 3.0 pf

Characteristics, Class A₁ Amplifier:

Plate Supply Voltage 125 volts

Grid-No.3 Voltage 0 volts

Grid-No.2 Supply Voltage 125 volts

Grid-No.1 Supply Voltage 0 volts

Cathode Resistor 56 ohms

Plate Resistance (Approx.) 160000 ohms

Transconductance 14000 μ mhos

Plate Current 15 ma

Grid-No.2 Current 4 ma

Grid-No.1 Voltage (Approx.) for transconductance (μ mhos) = 600 -4.5 volts

Mechanical:

Operating Position Any

Type of Cathode Coated Unipotential

Maximum Overall Length 2-3/16"

Maximum Seated Length 1-15/16"

Length, Base Seat to Bulb Top (Excluding tip) 1-9/16" \pm 3/32"

Diameter 0.750" to 0.875"

Dimensional Outline See *General Section*

Bulb T6-1/2

Base Small-Button Noval 9-Pin (JEDEC No.E9-1)



6JD6

Basing Designation for BOTTOM VIEW. 9PM

- Pin 1 -Cathode
- Pin 2 -Grid No.1
- Pin 3 -Cathode
- Pin 4 -Heater
- Pin 5 -Heater
- Pin 6 -No Internal Connection

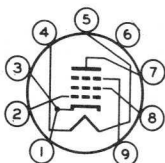

- Pin 7 -Plate
- Pin 8 -Grid No.2
- Pin 9 -Grid No.3
- Internal Shield

AMPLIFIER — Class A₁

Maximum Ratings, Design-Maximum Values:

- PLATE VOLTAGE 330 max. volts
- GRID-NO.3 (SUPPRESSOR-GRID) VOLTAGE:
 - Positive value. 0 max. volts
- GRID-NO.2 (SCREEN-GRID) SUPPLY VOLTAGE. . . 330 max. volts
- GRID-NO.2 VOLTAGE See *Grid-No.2 Input Rating Chart*
at front of Receiving Tube Section
- GRID-NO.1 (CONTROL-GRID) VOLTAGE:
 - Positive-bias value 0 max. volts
- GRID-NO.2 INPUT:
 - For grid-No.2 voltages up to 165 volts 0.6 max. watt
 - For grid-No.2 voltages between 165 and 330 volts . See *Grid-No.2 Input Rating Chart*
at front of Receiving Tube Section
- PLATE DISSIPATION 2.5 max. watts

Maximum Circuit Values:

- Grid-No.1-Circuit Resistance:
 - For fixed-bias operation. 0.25 max. megohm
 - For cathode-bias operation. 1 max. megohm

^a The dc component must not exceed 100 volts.
^b without external shield.



AVERAGE CHARACTERISTICS

 $E_f = 6.3$ VOLTS

GRID No.3 CONNECTED TO CATHODE AT SOCKET.

GRID-No.2 VOLTS = 125

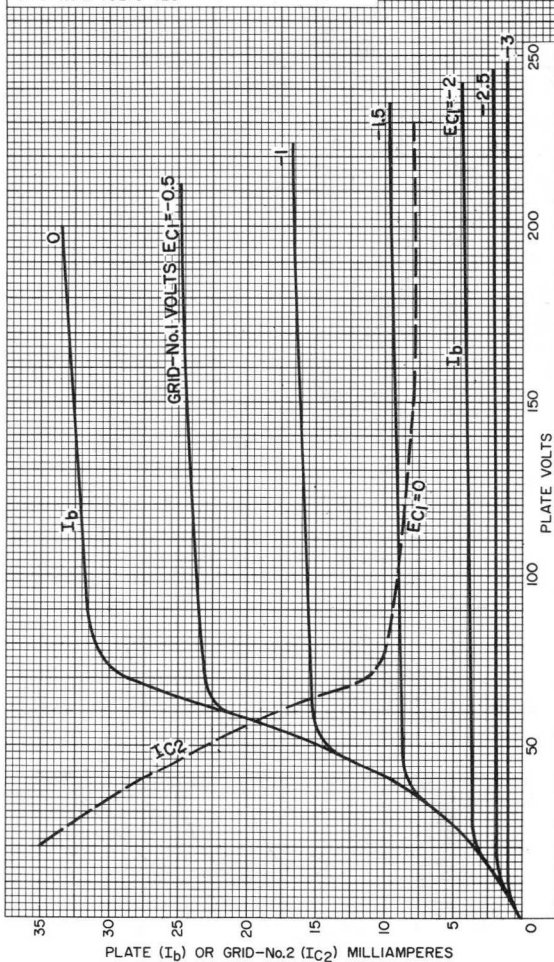

92CM-11951



AVERAGE CHARACTERISTICS

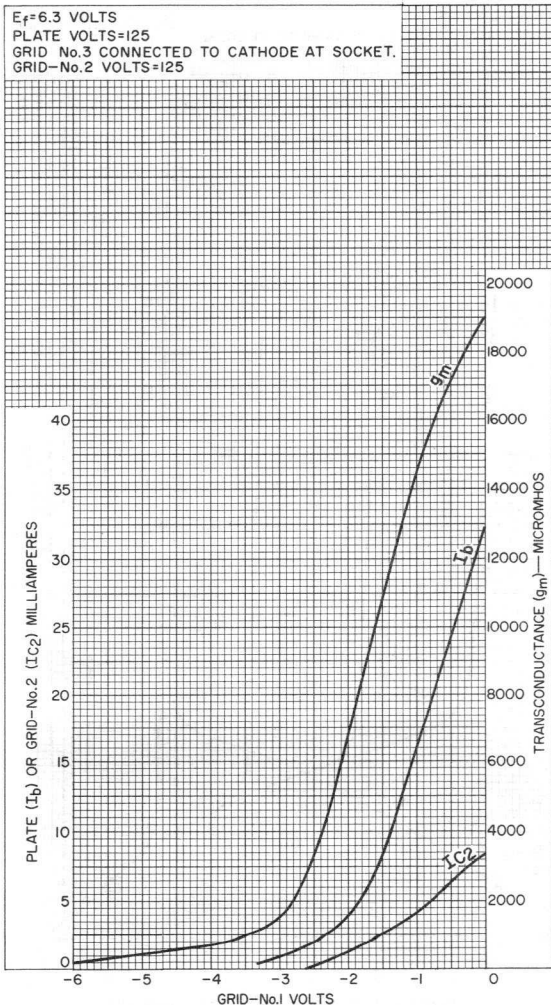

92CM-11952R1



Beam Power Tube

NOVAR TYPE

For Horizontal-Deflection-Amplifier Service
in Low-B+, Black-and-White TV Receivers

ELECTRICAL

Heater Characteristics and Ratings

Voltage (AC or DC)	6.3 ± 0.6	V
Current at 6.3 V.	1.600	A
Maximum heater-cathode voltage:		
Heater negative with respect to cathode:		
Peak	200	V
Heater positive with respect to cathode:		
Peak	200	V
DC component	100	V

Direct Interelectrode Capacitances (Approx.)^a

Grid No.1 to plate	1.2	pF
Input: G1 to (K, G3, G2, H)	22.0	pF
Output: P to (K, G3, G2, H)	9.0	pF

MECHANICAL

Operating Position	Any
Type of Cathode	Coated Unipotential
Maximum Overall Length	3.550 in
Seated Length	2.910 to 3.170 in
Diameter	1.438 to 1.562 in
Dimensional Outline	See <i>General Section</i>
Bulb	T12
Cap	Skirted Miniature (JEDEC No. C1-2 or C1-3)
Base	Large-Button Novar 9-Pin with Exhaust Tip (JEDEC No. E9-88)

TERMINAL DIAGRAM (Bottom View)

- Pin 1 - Grid No.2
- Pin 2 - Grid No.1
- Pin 3 - Cathode
- Pin 4 - Heater
- Pin 5 - Heater
- Pin 6 - Grid No.1
- Pin 7 - Grid No.2
- Pin 8 - Grid No.3
- Pin 9 - Do Not Use
- Cap - Plate

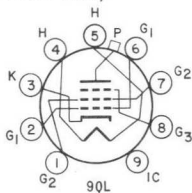

CHARACTERISTICS

Peak Positive-Pulse Plate Voltage ^b	6500	-	-	V
Plate Voltage	-	50	130	V
Grid No.3	Connected to cathode at socket			
Grid-No.2 Voltage	125	125	125	V
Grid-No.1 Voltage	-	0	-20	V
Plate Resistance (Approx.)	-	-	12000	Ω



6JF6

Transconductance	-	-	10000	μ mho
Plate Current	-	525 ^c	80	mA
Grid-No.2 Current		32 ^c	2.5	mA
Grid-No.1 Voltage (Approx.)	-125	-	-40	V

For plate mA = 1

Triode Amplification Factor (Triode connection: grid No.2 connected to plate at socket. Plate volts = grid-No.2 volts = 125; grid-No.1 volts = -20)	-	-	4.1	
---	---	---	-----	--

HORIZONTAL-DEFLECTION AMPLIFIER

Maximum Ratings, Design-Maximum Values

For operation in a 525-line, 30-frame system

DC Plate Supply Voltage		770	V
Peak Positive-Pulse Plate Voltage ^d		6500	V
Peak Negative-Pulse Plate Voltage		1500	V
DC Grid-No.3 Voltage ^e		100	V
DC Grid-No.2 (Screen-Grid) Voltage		220	V
Peak Negative-Pulse Grid-No.1 (Control-Grid) Voltage		330	V
Cathode Current			
Peak		950	mA
Average		275	mA
Grid-No.2 Input		3.5	W
Plate Dissipation ^f		17	W
Bulb Temperature		240	°C

At hottest point on bulb surface

MAXIMUM CIRCUIT VALUES

Grid-No.1-Circuit Resistance

For grid-resistor-bias operation ^f	0.47	M Ω
For plate-pulsed operation	10	M Ω

(Horizontal-deflection circuits only)

^a Without external shield.

^b Under conditions shown in footnote^d.

^c This value can be measured by a method involving a recurrent waveform such that the maximum ratings of the tube will not be exceeded.

^d This rating is applicable where the duration of the voltage pulse does not exceed 15 per cent of one horizontal scanning cycle. In a 525-line, 30-frame system, 15 per cent of one horizontal scanning cycle is 10 microseconds.

^e In horizontal-deflection-amplifier service, a positive voltage may be applied to grid No.3 to reduce interference from "snivets" which may occur in both vhf and uhf television receivers. Atypical value for this voltage is 50 volts.

^f An adequate bias resistor or other means is required to protect the tube in the absence of excitation.



Average Characteristics

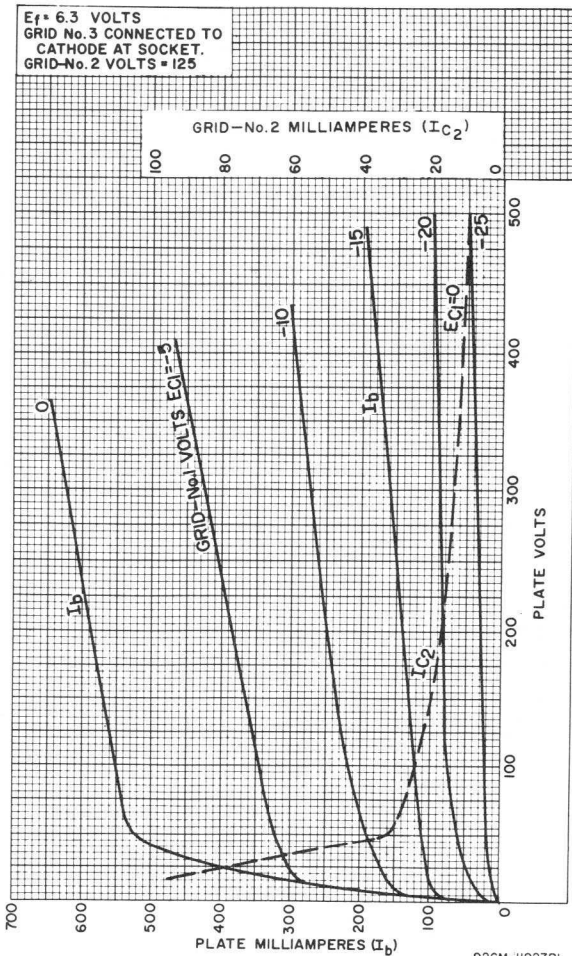

92CM-11927R1



Average Characteristics

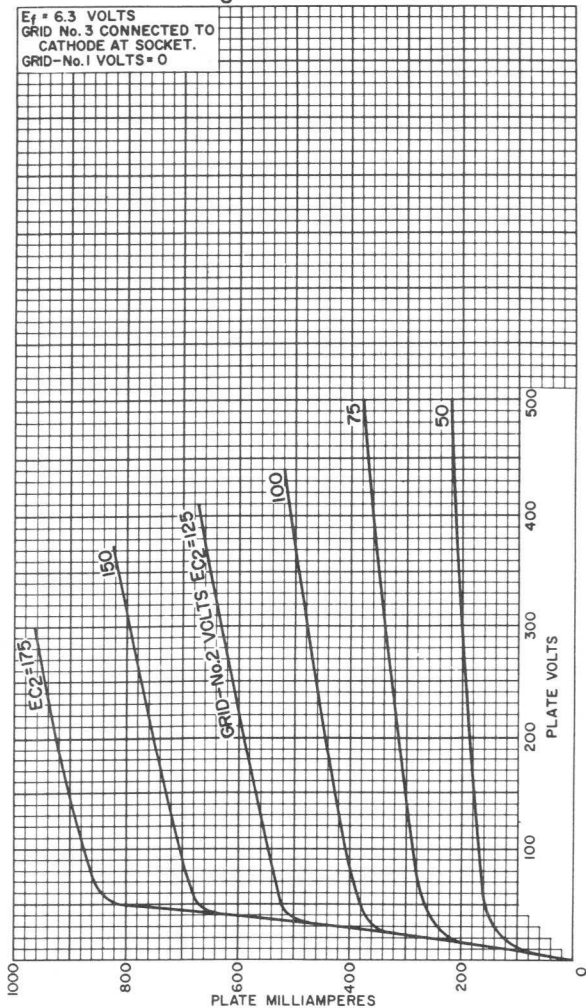

92CM-11923R2



Beam Power Tube

NOVAR TYPE

SEPARATE GRID-No.3 BASE-PIN TERMINAL FOR "SNIVETS" CONTROL^a

For Horizontal-Deflection-Amplifier Service
in Low-B+ Black-and-White TV Receivers

Electrical:

Heater Characteristics and Ratings:

Voltage (AC or DC)	6.3 ± 0.6	volts
Current at heater volts = 6.3	1.600	amp
Peak heater-cathode voltage:		
Heater negative with respect to cathode	200 max.	volts
Heater positive with respect to cathode	200 ^b max.	volts

Direct Interelectrode Capacitances (Approx.)^c

Grid No.1 to plate	0.7	pf
Input: G1 to (K,G3,G2,H)	22.0	pf
Output: P to (K,G3,G2,H)	9.0	pf

Mechanical:

Operating Position	Any
Type of Cathode	Coated Unipotential
Maximum Overall Length	3.130"
Seated Length	2.500" to 2.750"
Diameter	1.438" to 1.562"
Dimensional Outline	See <i>General Section</i>
Bulb	T12
Base	Large-Button Novar 9-Pin with Exhaust Tip (JEDEC No. E9-88)

Basing Designation for BOTTOM VIEW 9QU

- Pin 1 - Grid No.2
- Pin 2 - Grid No.1
- Pin 3 - Cathode
- Pin 4 - Heater
- Pin 5 - Heater
- Pin 6 - Grid No.3
- Pin 7 - Grid No.2
- Pin 8 - Do Not Use
- Pin 9 - Plate

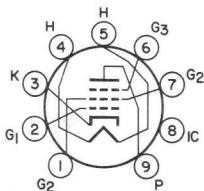

Characteristics, Class A₁ Amplifier:

	Triode Connection ^d	Pentode Connection	
Plate Voltage	125	50	130 volts
Grid No.3	Connected to cathode at socket		
Grid-No.2 Voltage	-	125	125 volts
Grid-No.1 Voltage	-20	0	-20 volts
Amplification Factor	4.1	-	-
Plate Resistance (Approx.)	-	-	12000 ohms
Transconductance	-	-	10000 μ hos
Plate Current	-	525 ^e	80 ma
Grid-No.2 Current	-	32 ^e	2.5 ma
Grid-No.1 Voltage (Approx.) for plate ma = 1	-	-	-40 volts



6JG6A

HORIZONTAL-DEFLECTION AMPLIFIER

Maximum Ratings, Design-Maximum Values:

For operation in a 525-line, 30-frame system^f

DC Plate Supply Voltage.	770 max.	volts
Peak-Positive-Pulse Plate Voltage ^g	6500 max.	volts
Peak Negative-Pulse Plate Voltage.	1500 max.	volts
DC Grid-No.3 (Suppressor-Grid) Voltage ^a	75 max.	volts
DC Grid-No.2 (Screen-Grid) Voltage	220 max.	volts
DC Grid-No.1 (Control-Grid) Voltage:		
Negative-bias value.	55 max.	volts
Peak Negative-Pulse Grid-No.1 Voltage.	330 max.	volts
Cathode Current:		
Peak	950 max.	ma
Average.	275 max.	ma
Grid-No.2 Input.	3.5 max.	watts
Plate Dissipation ^h	17 max.	watts
Bulb Temperature (At hottest point on bulb surface)	220 max.	°C

Maximum Circuit Values:

Grid-No.1-Circuit Resistance:		
For grid-No.1-resistor-bias operation.	2.2 max.	megohms

^a A positive voltage may be applied to grid No.3 to reduce interference from "snivets" which may occur in television receivers. A typical value for this voltage is 30 volts.

^b The dc component must not exceed 100 volts.

^c Without external shield.

^d With grid No.2 connected to plate at socket.

^e This value can be measured by a method involving a recurrent waveform such that the maximum ratings of the tube will not be exceeded.

^f As described in "Standards of Good Engineering Practice Concerning Television Broadcast Stations," Federal Communications Commission.

^g This rating is applicable where the duration of the voltage pulse does not exceed 15 per cent of one horizontal scanning cycle. In a 525-line, 30-frame system 15 per cent of one horizontal scanning cycle is 10 microseconds.

^h An adequate bias resistor or other means is required to protect the tube in the absence of excitation.



AVERAGE CHARACTERISTICS

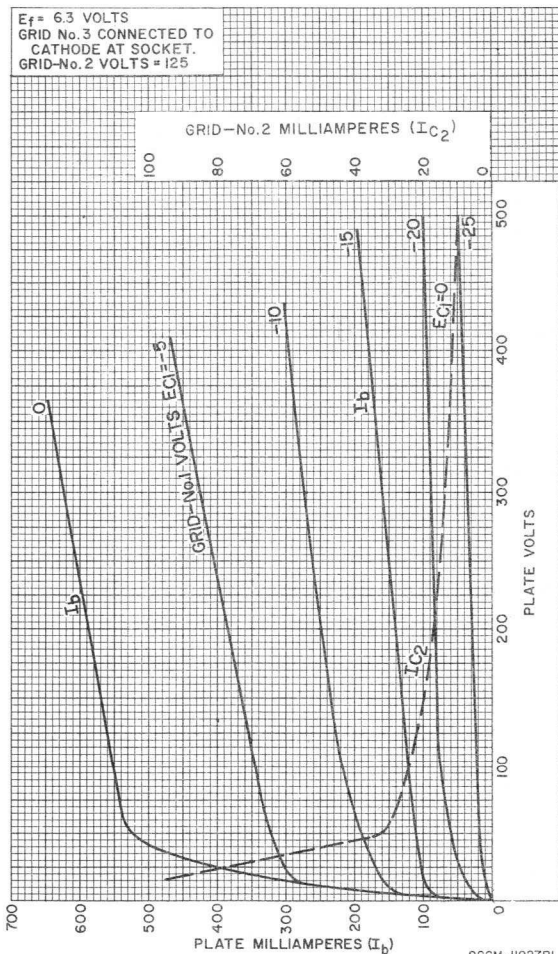

6JG6A

AVERAGE PLATE CHARACTERISTICS

$E_f = 6.3$ VOLTS
GRID No. 3 CONNECTED TO
CATHODE AT SOCKET.
GRID-No.1 VOLTS = 0

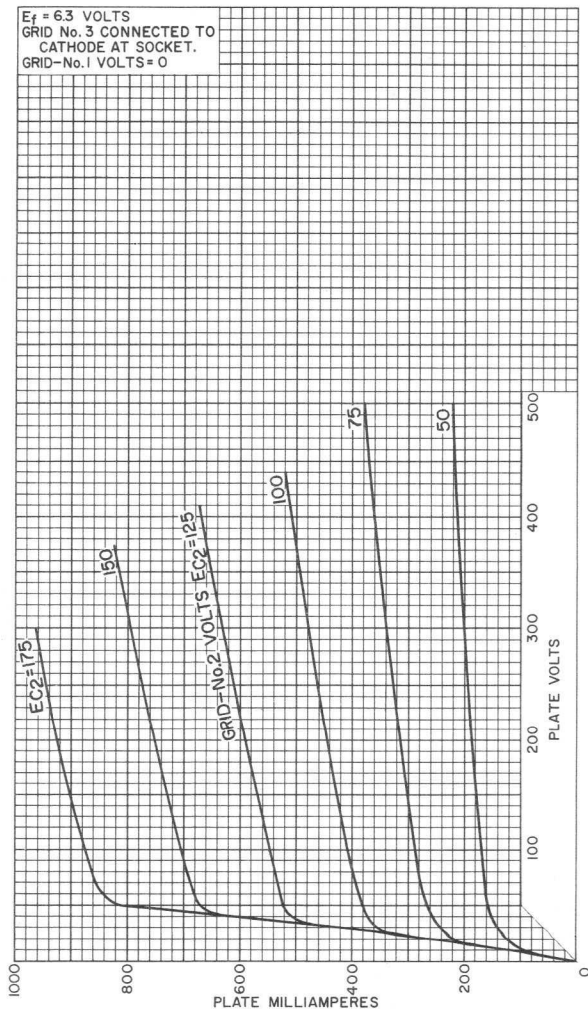

92CM-11923RI



Semiremote-Cutoff Pentode

7-PIN MINIATURE TYPE

For Use in Gain-Controlled Picture-IF
Amplifier Stages of Color TV Receivers

GENERAL DATA

Electrical:

Heater Characteristics and Ratings:

Voltage (AC or DC)	6.3 ± 0.6	volts
Current at heater volts = 6.3	0.300	amp
Peak heater-cathode voltage:		
Heater negative with respect to cathode	200	volts
Heater positive with respect to cathode	200 ^a	volts

Direct Interelectrode Capacitances:

	Without External Shield	With External Shield ^b	
Grid No.1 to plate	0.025 max.	0.015 max.	pf
Grid No.1 to cathode, grid No.3 & internal shield, grid No.2, and heater	7	7	pf
Plate to cathode, grid No.3 & internal shield, grid No.2, and heater	2	3	pf

Characteristics, Class A₁ Amplifier:

Plate Supply Voltage	125	volts
Grid No.3	Connected to cathode at socket	
Grid-No.2 Supply Voltage	125	volts
Cathode Resistor	56	ohms
Plate Resistance (Approx.)	0.26	megohm
Transconductance	8000	μmhos
Plate Current	14	ma
Grid-No.2 Current	3.6	ma
Grid-No.1 Voltage (Approx.) for transconductance (μmhos) = 50 and cathode resistor (ohms) = 0	-19	volts
Transconductance Range for grid- No.1 volts = -4.5 and cathode resistor of 56 ohms	400 - 900	μmhos

Mechanical:

Mounting Position	Any
Type of Cathode	Coated Unipotential
Maximum Overall Length	2-1/8"
Maximum Seated Length	1-7/8"
Length, Base Seat to Bulb Top (Excluding tip)	1-1/2" ± 3/32"
Diameter	0.650" to 0.750"



6JH6

Dimensional Outline See *General Section*
Bulb. T5-1/2
Base. Small-Button Miniature 7-Pin (JEDEC No.E7-1)
Basing Designation for BOTTOM VIEW. 7CM

Pin 1 - Grid No.1
Pin 2 - Cathode
Pin 3 - Heater
Pin 4 - Heater

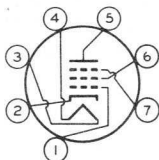

Pin 5 - Plate
Pin 6 - Grid No.2
Pin 7 - Grid No.3,
Internal
Shield

AMPLIFIER — Class A₁

Maximum Ratings, *Design-Maximum Values:*

PLATE VOLTAGE 300 max. volts
GRID-No.3 (SUPPRESSOR-GRID) VOLTAGE 0 max. volts
GRID-No.2 (SCREEN-GRID) SUPPLY VOLTAGE. 300 max. volts
GRID-No.2 VOLTAGE See *Grid-No.2 Input Rating Chart*
at front of Receiving Tube Section
GRID-No.1 (CONTROL-GRID) VOLTAGE:
Positive-bias value 0 max. volts
GRID-No.2 INPUT:
For grid-No.2 voltages
up to 150 volts 0.55 max. watt
For grid-No.2 voltages
between 150 and 300 volts . See *Grid-No.2 Input Rating Chart*
at front of Receiving Tube Section
PLATE DISSIPATION 2.3 max. watts

Maximum Circuit Values:

Grid-No.1-Circuit Resistance:

For fixed-bias operation. 0.25 max. megohm
For cathode-bias operation. 1 max. megohm

^a The dc component must not exceed 100 volts.

^b With external shield JEDEC No.316 connected to cathode.



AVERAGE CHARACTERISTICS

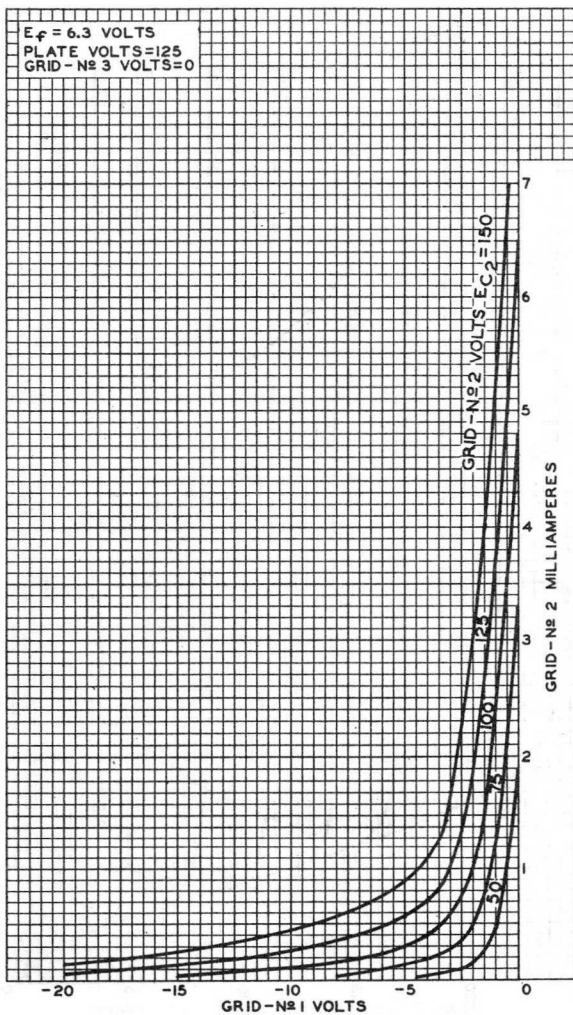

92CM-9485RI



RADIO CORPORATION OF AMERICA
 Electron Tube Division
 Harrison, N. J.

DATA 2
 4-63

AVERAGE CHARACTERISTICS

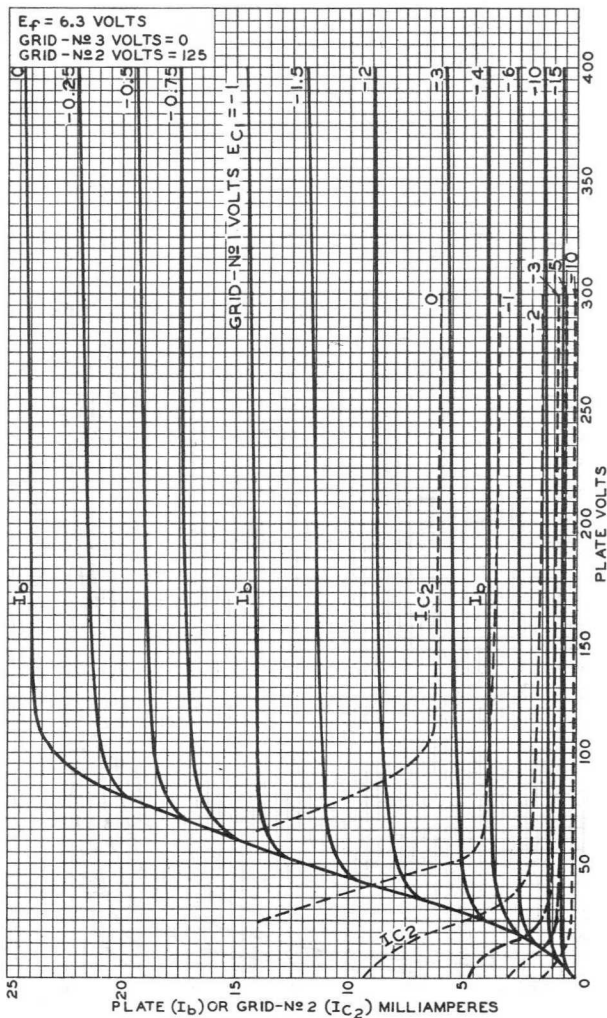

92CM-8508R2



AVERAGE CHARACTERISTICS

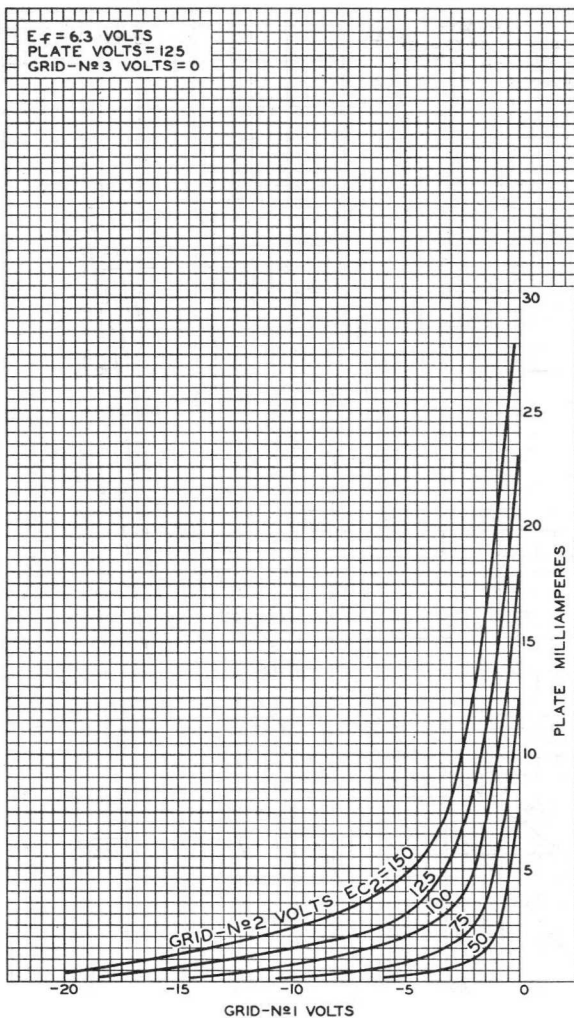

92CM-9481R1



6JH6

AVERAGE CHARACTERISTICS

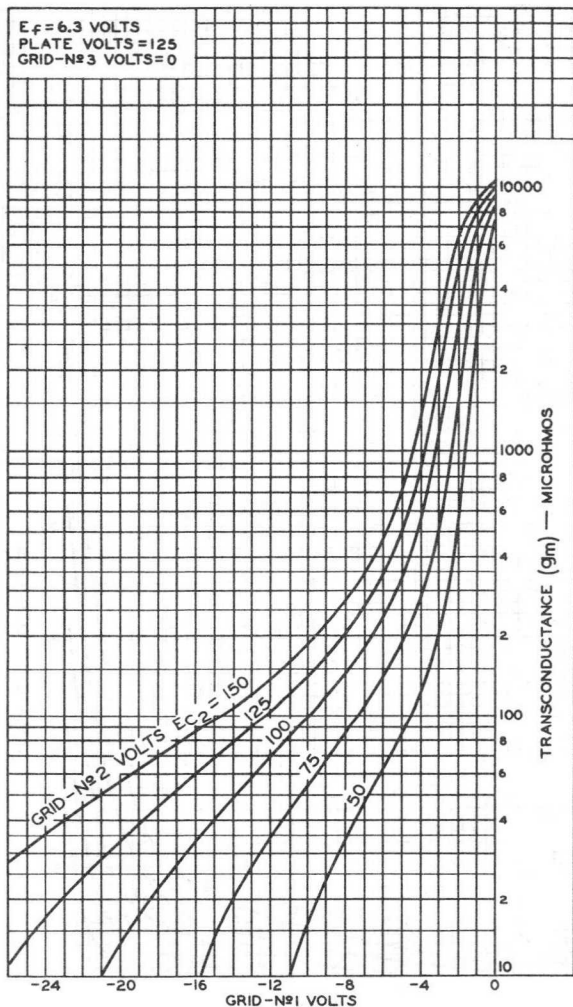

92CM-8509R1



Beam-Deflection Tube

9-PIN MINIATURE TYPE

GENERAL DATA

Electrical:

Heater Characteristics and Ratings (*Design-Maximum Values*):

Voltage (AC or DC)	6.3 ± 0.6	volts
Current at heater volts = 6.3	0.300	amp

Direct Interelectrode Capacitances:^a

Grid No.1 to all other electrodes except both plates.	7.5	μf
Grid No.1 to deflecting electrode No.1.	0.04 max.	μf
Grid No.1 to deflecting electrode No.2.	0.07 max.	μf
Plate No.1 to all other electrodes.	5.0	μf
Plate No.2 to all other electrodes.	5.0	μf
Plate No.1 to plate No.2.	0.4	μf
Deflecting electrode No.1 to all other electrodes	4.8	μf
Deflecting electrode No.2 to all other electrodes	4.8	μf
Deflecting electrode No.1 to deflecting electrode No.2.	0.38	μf

Characteristics, Class A₁ Amplifier:

*With both plates connected together and with both
deflecting electrodes connected to cathode at socket*

Plate-No.1 Supply Voltage	250	volts
Plate-No.2 Supply Voltage	250	volts
Grid-No.3 Voltage	250	volts
Cathode Resistor.	220	ohms
Total Plate Current	14	ma
Grid-No.3 Current	1.5	ma
Transconductance.	4400	μmhos
Grid-No.1 Voltage (Approx.) for total plate $\mu a = 10$	-13	volts

Mechanical:

Operating Position.	Any
Type of Cathode	Coated Unipotential
Maximum Overall Length.	2-5/8"
Maximum Seated Length	2-3/8"
Length, Base Seat to Bulb Top (Excluding tip)	2" ± 3/32"
Diameter.	0.750" to 0.875"
Dimensional Outline	See <i>General Section</i>
Bulb.	T6-1/2
Base.	Small-Button Noval 9-Pin (JEDEC No.E9-1)



6JH8

Basing Designation for BOTTOM VIEW. 9DP

- Pin 1 - Deflecting Electrode No. 2
- Pin 2 - Deflecting Electrode No. 1
- Pin 3 - Grid No. 3
- Pin 4 - Heater

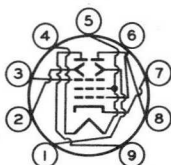

- Pin 5^b - Heater, Internal Shield, Grid No. 2
- Pin 6 - Grid No. 1
- Pin 7 - Cathode
- Pin 8 - Plate No. 2
- Pin 9 - Plate No. 1

COLOR-TV DEMODULATOR

Maximum Ratings, Design-Maximum Values:

PLATE VOLTAGE (Each plate)	330 max.	volts
PEAK DEFLECTING-ELECTRODE VOLTAGE (Each electrode):		
Negative value	165 max.	volts
Positive value	165 max.	volts
GRID-No. 3 (ACCELERATING-GRID) VOLTAGE	330 max.	volts
GRID-No. 2 (FOCUSING-GRID) VOLTAGE	<i>Connect to cathode at socket</i>	
GRID-No. 1 (CONTROL-GRID) VOLTAGE:		
Positive-bias value	0 max.	volts
GRID-No. 3 INPUT	1 max.	watt
CATHODE CURRENT	33 max.	ma
PLATE DISSIPATION (Each plate)	3 max.	watts

Typical Operation:

Plate Supply Voltage (Each plate)	250	volts
Grid-No. 3 Voltage	250	volts
Grid No. 2	<i>Connected to cathode at socket</i>	
Cathode Resistor	220	ohms
Maximum Deflecting-Electrode Switching Voltage ^c	20	volts
Deflecting-Electrode Voltage for minimum deflecting-electrode switching voltage ^c	-14	volts
Voltage Difference Between Deflecting Electrodes for plate-No. 1 current and plate-No. 2 current to be equal	0	volts
Maximum Plate-No. 1 Current for deflecting-electrode-No. 1 volts = -15, and deflecting-electrode-No. 2 volts = +15.	0.7	ma
Maximum Plate-No. 2 Current for deflecting-electrode-No. 1 volts = +15, and deflecting-electrode-No. 2 volts = -15.	0.7	ma



Maximum Deflecting-Electrode-No.1 Current for deflecting- electrode-No.1 volts = +25, and deflecting-electrode-No.2 volts = -25	0.1	ma
Maximum Deflecting-Electrode-No.2 Current for deflecting- electrode-No.1 volts = -25, and deflecting-electrode-No.2 volts = +25	0.1	ma

Maximum Circuit Values:

Grid-No.1-Circuit Resistance:		
For fixed-bias operation.	0.1 max.	megohm
For cathode-bias operation.	0.25 max.	megohm

a Without external shield.

b Pin 5 should be connected directly to cathode at socket.

c The Deflecting-Electrode Switching Voltage is the total voltage change on either deflecting electrode with an equal and opposite voltage change on the other deflecting electrode required to switch the plate current from one plate to the other plate.

OPERATING CONSIDERATIONS

This type should be located in equipment so that it is not subjected to stray magnetic fields which may affect the intrinsic operating plate-current balance.



Average Plate Characteristics

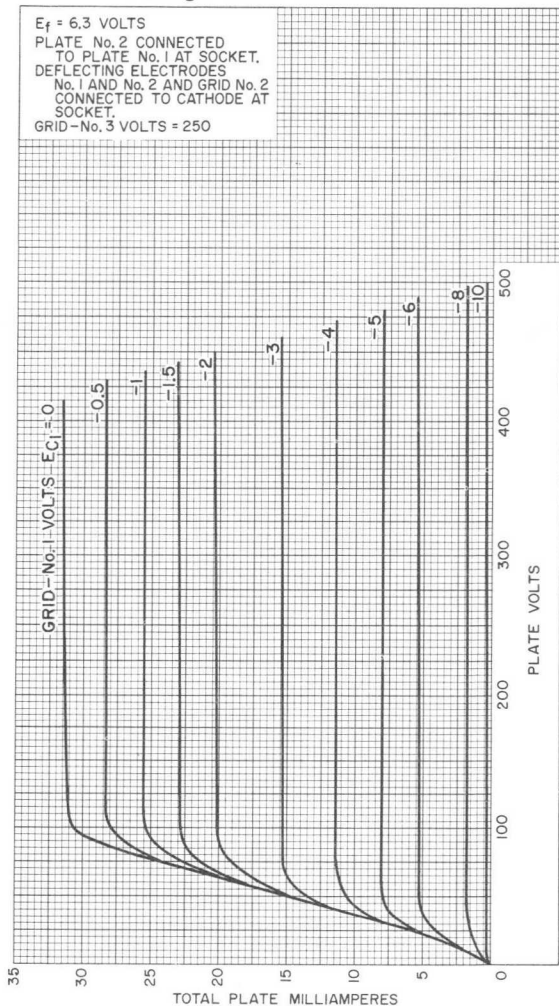

92CM-12938



Average Characteristics

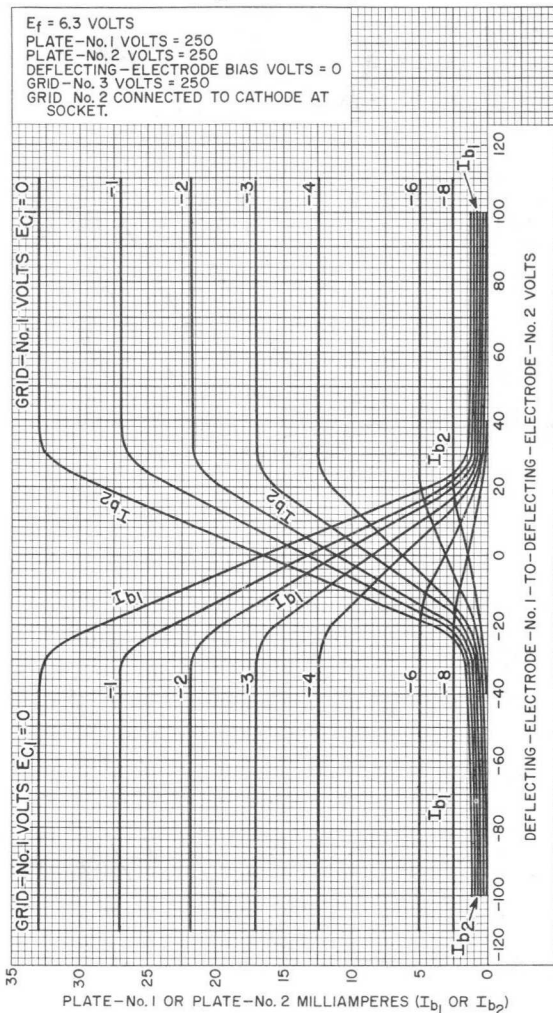

92CM-12939



Average Characteristics

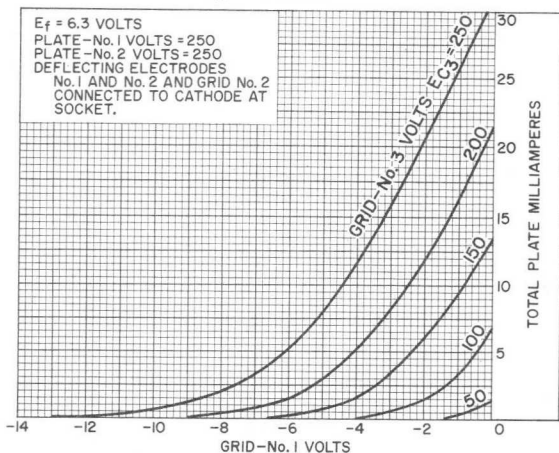

92CS-12936

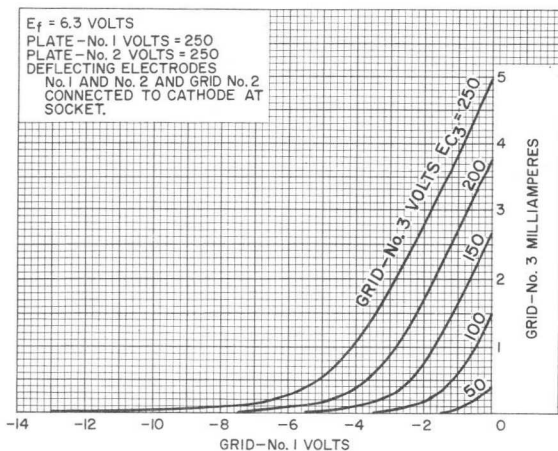

92CS-12937



Beam Power Tube

with an Integral Diode

9-PIN MINIATURE TYPE

PLATE DISSIPATION = 10 WATTS

DARK HEATER

*For Feedback-Stabilized Vertical Deflection**Amplifier Applications in Black-and-White and Color TV Receivers*

ELECTRICAL CHARACTERISTICS

Bogey Values

Heater Voltage (AC or DC)	E_h	6.3	V
Heater Current	I_h	1.2	A
Direct Interelectrode Capacitances Without external shield			
Grid No.1 to plate	e_{g1-p}	0.32	pF
Input: G1 to (K, G3+P _D , G2, H)	c_i	13.0	pF
Output: P to (K, G3+P _D , G2, H)	c_o	6.0	pF

For the following characteristics, see Conditions

Amplification Factor (Triode Connection) ^a	μ	6.5	
Plate Resistance (Approx.)	r_p	10.5	k Ω
Transconductance	g_m	4200	μ mho
DC Plate Current	I_b	150 ^b	35 mA
DC Grid-No.2 Current	I_{c2}	20 ^b	2.5 mA
Cutoff DC Grid-No.1 Voltage	$E_{c1}(co)$	-37	V
Plate mA = 1			
Instantaneous Diode-Plate-to-Cathode-Voltage Drop for instantaneous diode-plate current ($r_b(d)$) = 2 mA	$e_b(d)$	5	V

Conditions

Heater	E_h	6.3	6.3	V
DC Plate Voltage	E_b	40	140	V
DC Grid-No.3 Voltage	E_{c3}	0	0	V
DC Grid-No.2 Voltage	E_{c2}	120	140	V
DC Grid-No.1 Voltage	E_{c1}	0	-18	V

MECHANICAL CHARACTERISTICS

Operating Position				Any
Type of Cathode				Coated Unipotential
Dimensional Outline (JEDEC 6-4)				See General Section
Maximum Overall Length		3.062 in (77.77 mm)		
Maximum Seated Length		2.812 in (71.42 mm)		
Maximum Diameter		0.875 in (22.22 mm)		
Envelope				JEDEC Designation T6-1/2
Base				Small-Button Noval 9-Pin (JEDEC Designation E9-1)
Terminal Diagram				9RA



TERMINAL DIAGRAM (Bottom View)

- Pin 1 - Plate
- Pin 2 - Do Not Use
- Pin 3 - Grid No. 2
- Pin 4 - Heater
- Pin 5 - Heater
- Pin 6 - Grid No. 3,
Diode Plate
- Pin 7 - Grid No. 1
- Pin 8 - Grid No. 1
- Pin 9 - Cathode

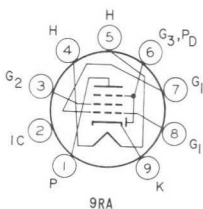

DESIGN-MAXIMUM RATINGS^c

For operation as a Feedback-Stabilized Vertical-Deflection-Amplifier Tube in Black-&White & Color Television Receivers in a 525-line, 30-frame system

DC Plate Voltage	E_b	425	V
Peak Positive-Pulse Plate Voltage (Absolute-Maximum Value) ^d	e_{bm}	2000	V
DC Grid-No. 3 & Diode-Plate Voltage.	$E_{c3}, E_b(d)$	+10	V
		-150	V
DC Grid-No. 2 (Screen-Grid) Voltage.	E_{c2}	330	V
Peak Negative-Pulse Grid-No. 1 (Control-Grid) Voltage	e_{c1m}	150	V
Heater-Cathode Voltage			
Peak	e_{hkm}	±200	V
Average ^e	$E_{hk}(av)$	100	V
Heater Voltage (AC or DC).	E_h	5.7 to 6.9	V
Cathode Current			
Peak	i_{km}	250	mA
Average ^e	$i_{k(av)}$	70	mA
Average Diode-Plate (& Grid-No. 3) Current ^e	$I_b(av) (d)$	1	mA
Grid-No. 2 Input	P_{g2}	2	W
Plate Dissipation	P_b	10	W
Envelope Temperature (At hottest point on envelope surface).	T_E	240	°C

MAXIMUM CIRCUIT VALUES

Grid-No. 1-Circuit Resistance	$R_{g1}(ckt)$		
For grid-No. 1-resistor-bias operation.	-	2.2	MΩ
For cathode-bias operation	-	2.2	MΩ

^a With grid No. 3 and diode plate connected to cathode and with grid No. 2 connected to plate at socket.

^b This value can be measured by a method involving a recurrent waveform such that the Maximum Ratings of the tube will not be exceeded.

^c Unless otherwise specified.

^d This rating is applicable where the duration of the voltage pulse does not exceed 15 per cent of one vertical scanning cycle. In a 525-line, 30-frame system, 15 per cent of one vertical scanning cycle is 2.5 ms.

^e Measured with a dc meter.



Typical Characteristics

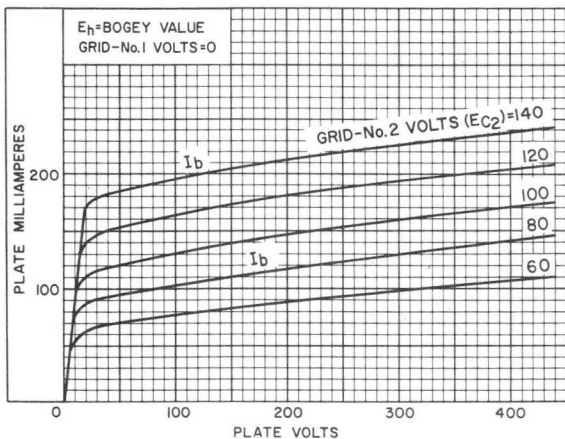

92CS-14660

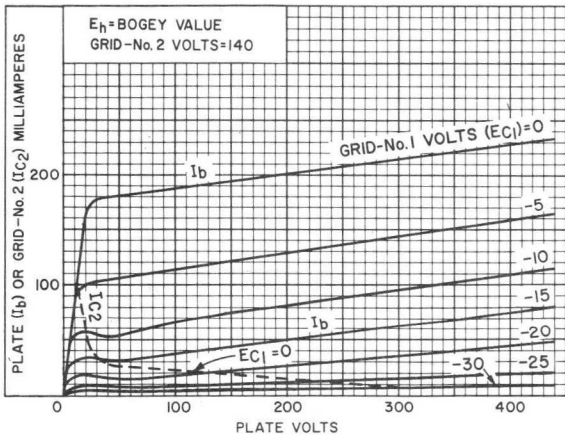

92CS-14661



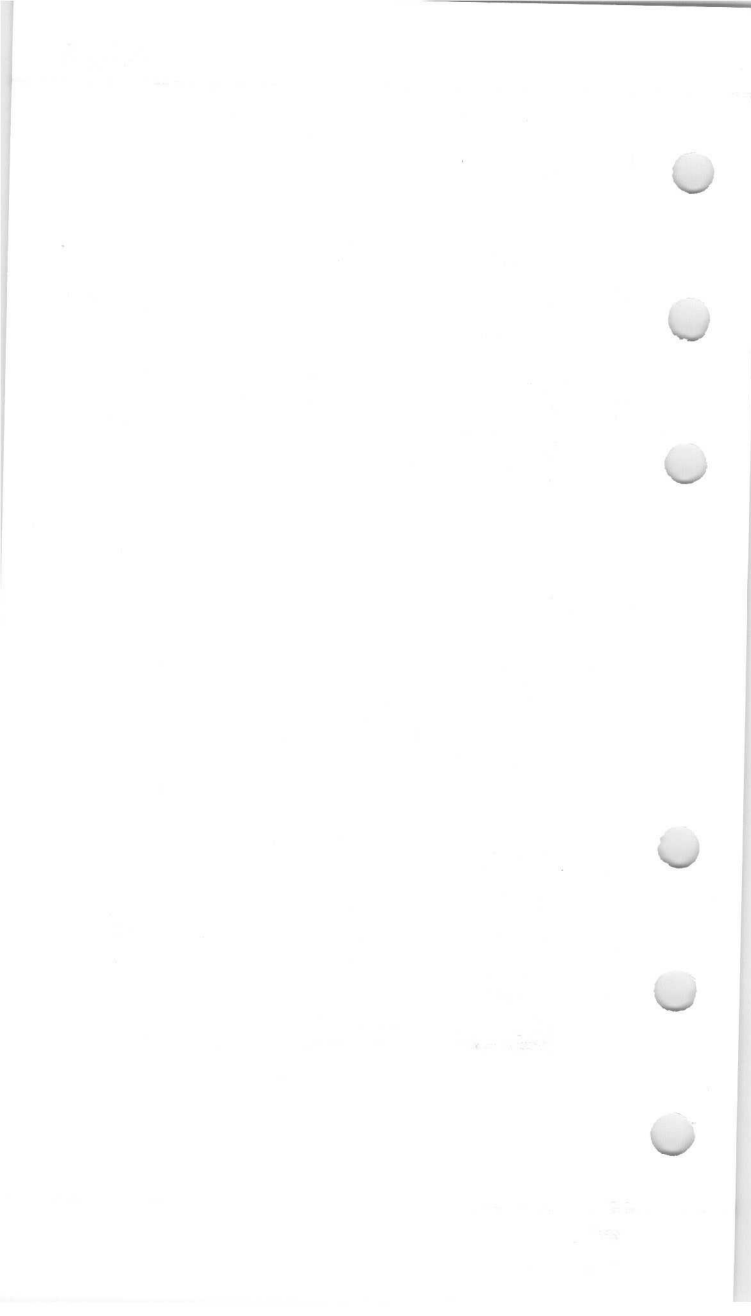

Beam Power Tube

Novar Type

For Horizontal-Deflection-Amplifier Service in
Low-B+, Black-and-White TV Receivers

ELECTRICAL CHARACTERISTICS - Bogey Values

Heater Voltage, ac or dc.	E_h	6.3	V
Heater Current	I_h	1.6	A
Direct Interelectrode Capacitances: ^a			
Grid No.1 to plate	c_{g1-p}	0.7	pF
Input: G1 to (K,G3,G2,H)	c_i	22.0	pF
Output: P to (K,G3,G2,H)	c_o	9.0	pF

For the following characteristics, see Conditions below:

Amplification Factor (Triode Connection) ^b	μ	-	-	4.7	-
Plate Resistance (Approx.)	r_p	-	-	-	18 k Ω
Transconductance	g_m	-	-	-	7000 μ mho
DC Plate Current	I_b	-	470 ^c	-	45 mA
DC Grid-No.2 Current	I_{c2}	-	32 ^c	-	1.5 mA
Cutoff DC Grid-No.1 Voltage for $I_b = 1$ mA	$E_{c1(co)}$	-75	-	-	-32 V

Conditions:

Heater Voltage	E_h	Bogey value			V
Peak Positive-Pulse Plate Voltage ^d	e_{bm}	6500	-	-	- V
DC Plate Voltage	E_b	-	50	125	130 V
Grid No.3	-	Connected to cathode at socket			
DC Grid-No.2 Voltage	E_{c2}	125	125	125	125 V
DC Grid-No.1 Voltage	E_{c1}	-	0	-20	-20 V

MECHANICAL CHARACTERISTICS

Maximum Overall Length	3.130 in (79.50 mm)
Maximum Seated Length	2.750 in (69.85 mm)
Maximum Diameter	1.562 in (39.67 mm)
Envelope	JEDEC Designation T12
Dimensional Outline	JEDEC Designation 12-96
Base ^e	Large-Button Novar 9-Pin with Exhaust Tip (JEDEC Designation E9-88)
Terminal Connections (See TERMINAL DIAGRAM)	JEDEC Designation 9QU
Type of Cathode	Coated Unipotential
Operating Position	Any

6JR6

MAXIMUM RATINGS - Design Maximum Values^f

*For operation as a Horizontal-Deflection-Amplifier
Tube in a 525-line, 30-frame system*

DC Plate Supply Voltage	E_{bb}	770	V
Peak Positive-Pulse Plate Voltage ^g	e_{bm}	6500	V
Peak Negative-Pulse Plate Voltage	$-e_{bm}$	1500	V
DC Grid-No.3 Voltage ^h	E_{c3}	75	V
DC Grid-No.2 (Screen-Grid) Voltage	E_{c2}	220	V
DC Grid-No.1 (Control-Grid) Voltage:			
Negative-bias value	$-E_{c1}$	55	V
Peak Negative-Pulse Grid No.1 Voltage	$-e_{clm}$	330	V
Heater-Cathode Voltage:			
Peak	e_{hkm}	±200	V
Average	$E_{hk(av)}$	100	V
Heater Voltage, ac or dc	E_h	5.7 to 6.9	V
Cathode Current:			
Peak	i_{km}	950	V
Average	$I_{k(av)}$	275	V
Grid-No.2 Input	P_{g2}	3.5	V
Plate Dissipation ^k	P_b	17	V
Envelope Temperature (at hottest point on envelope surface)	T_E	240	°C

MAXIMUM CIRCUIT VALUES

Grid-No.1-Circuit Resistance:	$R_{g1(ckt)}$		
For grid-No.1-resistor-bias operation		0.47	MΩ
For plate-pulsed operation (horizontal-deflection circuits only)		10	MΩ
^a Measured without external shield in accordance with the current issue of EIA Standard RS-191.			
^b With Grid No.2 connected to plate at socket.			
^c This value can be measured by a method involving a recurrent waveform such that the Maximum Ratings of the tube will not be exceeded.			
^d Under pulse-duration condition specified in Footnote ^g .			
^e Designed to mate with "Novar 9-contact" Socket generally available from your local RCA Distributor.			
^f As defined in the current issue of EIA Standard RS-239.			
^g This rating is applicable where the duration of the voltage pulse does not exceed 15% of one horizontal scanning cycle. In a 525-line, 30-frame system, 15% of one horizontal scanning cycle is 10 μs.			
^h In horizontal-deflection-amplifier service, a positive voltage may be applied to grid No.3 to reduce interference			

from "snivets" which may occur in both vhf and uhf television receivers. A typical operating value for this voltage is 30 V.

- k An adequate bias resistor or other means is required to protect the tube in the absence of excitation.

TERMINAL DIAGRAM (Bottom View)

- Pin 1 - Grid No.2
- Pin 2 - Grid No.1
- Pin 3 - Cathode
- Pin 4 - Heater
- Pin 5 - Heater
- Pin 6 - Grid No.3
- Pin 7 - Grid No.2
- Pin 8 - Do Not Use
- Pin 9 - Plate

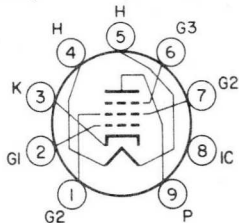

JEDEC 9QU

TYPICAL PLATE CHARACTERISTICS

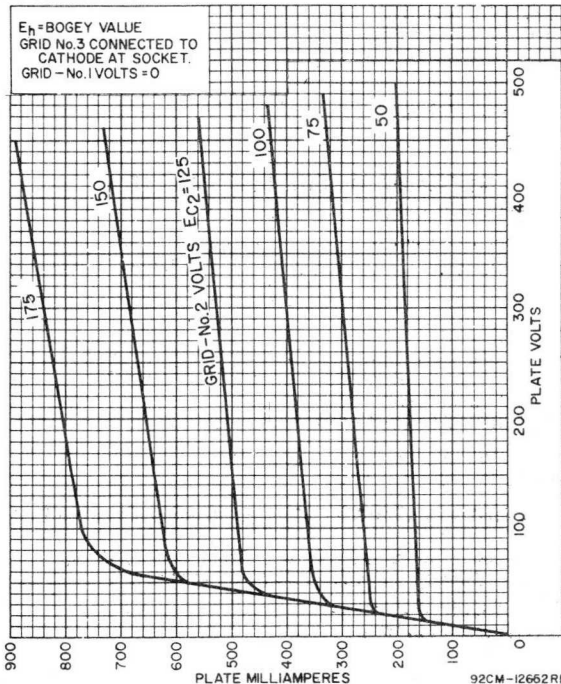

6JR6

TYPICAL CHARACTERISTICS

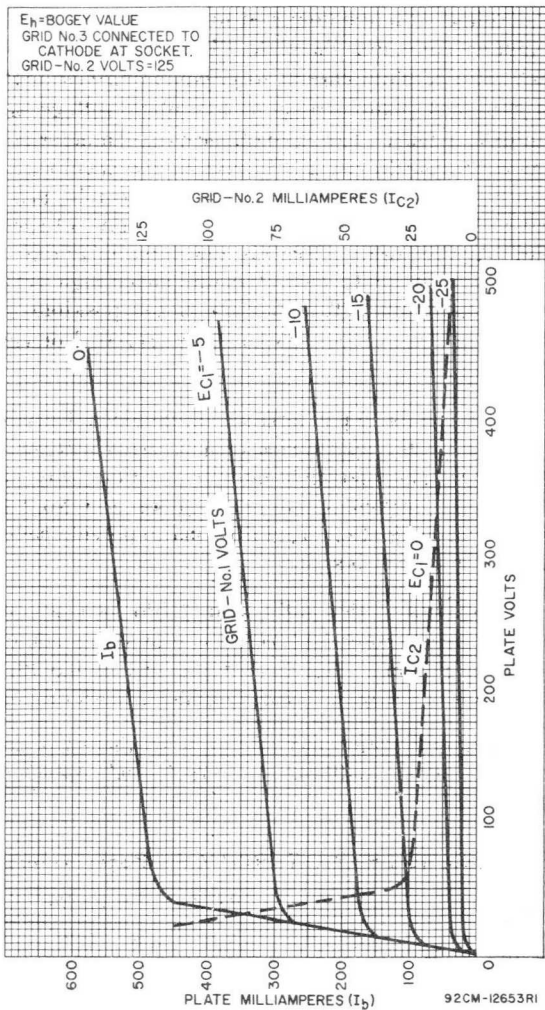

Beam Power Tube

NOVAR TYPE

SEPARATE GRID-No 3 BASE-PIN TERMINAL FOR "SNIVETS" CONTROL^a

For Horizontal-Deflection-Amplifier
Service in Black-and-White TV Receivers

Electrical:

Heater Ratings and Characteristics:

Voltage (AC or DC)	6.3 ± 0.6	volts
Current at heater volts = 6.3	1.200	amp
Peak heater-cathode voltage:		
Heater negative with respect to cathode.	200 max.	volts
Heater positive with respect to cathode.	200 ^b max.	volts

Direct Inter-electrode Capacitances (Approx.):^c

Grid No.1 to plate	0.26	pf
Input: G1 to (K, G3, G2, H)	15.0	pf
Output: P to (K, G3, G2, H)	6.5	pf

Mechanical:

Operating Position	Any
Type of Cathode	Coated Unipotential
Maximum Overall Length	2.880"
Seated Length	2.250" to 2.500"
Diameter	1.438" to 1.562"
Dimensional Outline	See <i>General Section</i>
Bulb	T12
Base	Large-Button Novar 9-Pin with Exhaust Tip (JEDEC No. E9-88)
Basing Designation for BOTTOM VIEW	9QU

- Pin 1 - Grid No.2
- Pin 2 - Grid No.1
- Pin 3 - Cathode
- Pin 4 - Heater

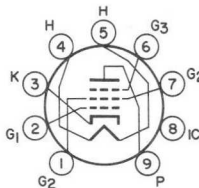

- Pin 5 - Heater
- Pin 6 - Grid No.3
- Pin 7 - Grid No.2
- Pin 8 - Do Not Use
- Pin 9 - Plate

Characteristics, Class A₁ Amplifier:

	Triode Connection ^d .	Pentode Connection	
Plate Voltage	150	60	250 volts
Grid No.3	-	Connected to Cathode at socket	
Grid-No.2 Voltage	150	150	150 volts
Grid-No.1 Voltage	-22.5	0	-22.5 volts
Amplification Factor	4.4	-	-
Plate Resistance (Approx.)	-	-	15000 ohms
Transconductance	-	-	7100 μmhos



6JT6A

	Triode Connection ^d	Pentode Connection	
Plate Current.	-	390 ^e 70	ma
Grid-No.2 Current.	-	32 ^e 2.1	ma
Grid-No.1 Voltage (Approx.) for plate ma = 1	-	-	-42 volts

HORIZONTAL-DEFLECTION AMPLIFIER

Maximum Ratings, Design-Maximum Values:

For operation in a 525-line, 30-frame system^f

DC Plate Supply Voltage.	770 max.	volts
Peak Positive-Pulse Plate Voltage ^g	6500 max.	volts
Peak Negative-Pulse Plate Voltage.	1500 max.	volts
DC Grid-No.3 (Suppressor-Grid) Voltage ^a	70 max.	volts
DC Grid-No.2 (Screen-Grid) Voltage	220 max.	volts
DC Grid-No.1 (Control-Grid) Voltage:		
Negative-bias value.	55 max.	volts
Peak Negative-Pulse Grid-No.1 Voltage.	330 max.	volts
Cathode Current:		
Peak	550 max.	ma
Average.	175 max.	ma
Grid-No.2 Input.	3.5 max.	watts
Plate Dissipation ^h	17.5 max.	watts
Bulb Temperature (At hottest point on bulb surface)	240 max.	°C

Maximum Circuit Values:

Grid-No.1-Circuit Resistance:	
For grid-resistor-bias operation	1 max. megohm

- ^a A positive voltage may be applied to grid No.3 to reduce interference from "snivets" which may occur in television receivers. A typical value for this voltage is 30 volts.
- ^b The dc component must not exceed 100 volts.
- ^c Without external shield.
- ^d With grid No.2 connected to plate at socket.
- ^e This value can be measured by a method involving a recurrent wave form such that the maximum ratings of the tube will not be exceeded.
- ^f As described in "Standards of Good Engineering Practice Concerning Television Broadcast Stations", Federal Communications Commission.
- ^g This rating is applicable where the duration of the voltage pulse does not exceed 15 per cent of one horizontal scanning cycle. In a 525-line, 30-frame system, 15 per cent of one horizontal scanning cycle is 10 microseconds.
- ^h An adequate bias resistor or other means is required to protect the tube in the absence of excitation.



AVERAGE CHARACTERISTICS

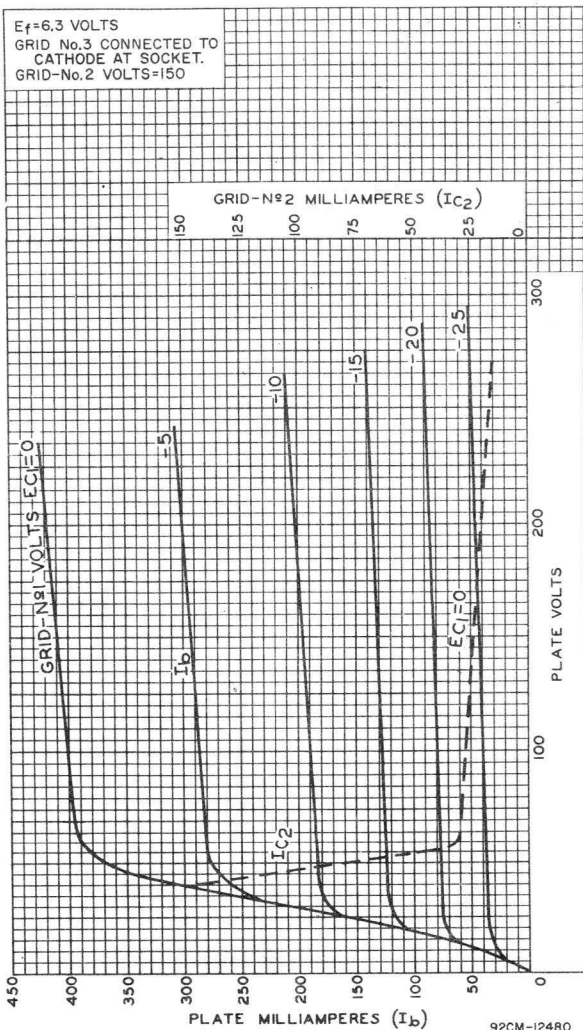



Beam Power Tube

NOVAR TYPE

For Horizontal-Deflection-Amplifier Service
in Low-B+, Black-and-White TV Receivers

ELECTRICAL CHARACTERISTICS

Bogey Values

Heater Voltage (AC or DC)	E_h	6.3	V
Heater Current	I_h	1.600	A
Direct Interelectrode Capacitances			
Without external shield			
Grid No.1 to plate	C_{g1-p}	1.2	pF
Input: G1 to (K, G3, G2, H)	C_i	22	pF
Output: P to (K, G3, G2, H)	C_o	9.0	pF

For the following characteristics, see Conditions

Amplification Factor	μ	-	-	4.7	-
Triode connection ^a					
Plate Resistance (Approx.)	r_p	-	-	-	18 k Ω
Transconductance	g_m	-	-	-	7000 μ mhos
DC Plate Current	I_b	-	470 ^b	-	45 mA
DC Grid-No.2 Current	I_{c2}	-	32 ^b	-	1.5 mA
Cutoff DC Grid-No.1 Voltage	$E_{c1}(co)$	-75	-	-	-32 V
Plate mA = 1					

Conditions

Heater Voltage	E_h	Bogey value			V
Peak Positive-Pulse					
Plate Voltage ^c	e_{bm}	6500	-	-	-
DC Plate Voltage	E_b	-	50	125	130
Grid No.3	Connected to cathode at socket				
DC Grid-No.2 Voltage	E_{c2}	125	125	125	125
DC Grid-No.1 Voltage	E_{c1}	-	0	-20	-20

MECHANICAL CHARACTERISTICS

Operating Position	Any
Type of Cathode	Coated Unipotential
Maximum Overall Length	3.550 in
Maximum Seated Length	3.170 in
Maximum Diameter	1.562 in
Dimensional Outline	See General Section
Envelope	JEDEC T12
Top Cap	Skirted Miniature (JEDEC C1-2 or C1-3)
Bases (alternates)	

Large-Button Novar 9-Pin (JEDEC E9-76)

Large-Button Novar 9-Pin with Exhaust Tip (JEDEC E9-88)



TERMINAL DIAGRAM (Bottom View)

- Pin 1 - Grid No. 2
- Pin 2 - Grid No. 1
- Pin 3 - Cathode
- Pin 4 - Heater
- Pin 5 - Heater
- Pin 6 - Grid No. 1
- Pin 7 - Grid No. 2
- Pin 8 - Grid No. 3
- Pin 9 - Do Not Use
- Top Cap - Plate

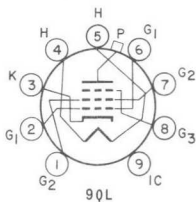

DESIGN-MAXIMUM RATINGS

*For operation as a Horizontal-Deflection-Amplifier
Tube in a 525-line, 30-frame system*

DC Plate Supply Voltage	Ebb	770	V
Peak Positive-Pulse Plate Voltage ^d . .	ebm	6500	V
Peak Negative-Pulse Plate Voltage . .	-ebm	1500	V
DC Grid-No.3 Voltage ^e	Ec3	75	V
DC Grid-No.2 (Screen-Grid) Voltage. .	Ec2	220	V
DC Grid-No.1 (Control-Grid) Voltage .	-Ec1	55	V
Negative-bias value			
Peak Negative-Pulse Grid-No.1 Voltage	-ec1m	330	V
Heater-Cathode Voltage			
Peak	ehkm	±200	V
Average	Ehk(av)	100	V
Heater Voltage (AC or DC)	Eh	5.7 to 6.9	V
Cathode Current			
Peak	ikm	950	mA
Average	Ik(av)	275	mA
Grid-No.2 Input	Pg2	3.5	W
Plate Dissipation ^f	Pb	17	W
Envelope Temperature.	TE	240	°C
At hottest point on envelope surface			

MAXIMUM CIRCUIT VALUES

Grid-No.1-Circuit Resistance	Rg1(ckt)		
For grid-No.1-resistor-bias operation.	-	0.47	MΩ
For plate-pulsed operation (horizontal-deflection circuits only)	-	10	MΩ

- ^a With grid No.2 connected to plate at socket.
- ^b This value can be measured by a method involving a recurrent waveform such that the Maximum Ratings of the tube will not be exceeded.
- ^c Under pulse-duration condition specified in Footnote d.
- ^d This rating is applicable where the duration of the voltage pulse does not exceed 15% of one horizontal scanning cycle. In a 525-line, 30-frame system, 15% of one horizontal scanning cycle is 10 μs.
- ^e In horizontal-deflection-amplifier service, a positive voltage may be applied to grid No.3 to reduce interference from "snivets" which may occur in both vhf and uhf television receivers. A typical operating value for this voltage is 30 V.
- ^f An adequate bias resistor or other means is required to protect the tube in the absence of excitation.



Typical Characteristics

E_h = BOGEY VALUE
 GRID No. 3 CONNECTED TO
 CATHODE AT SOCKET.
 GRID - No. 2 VOLTS = 125

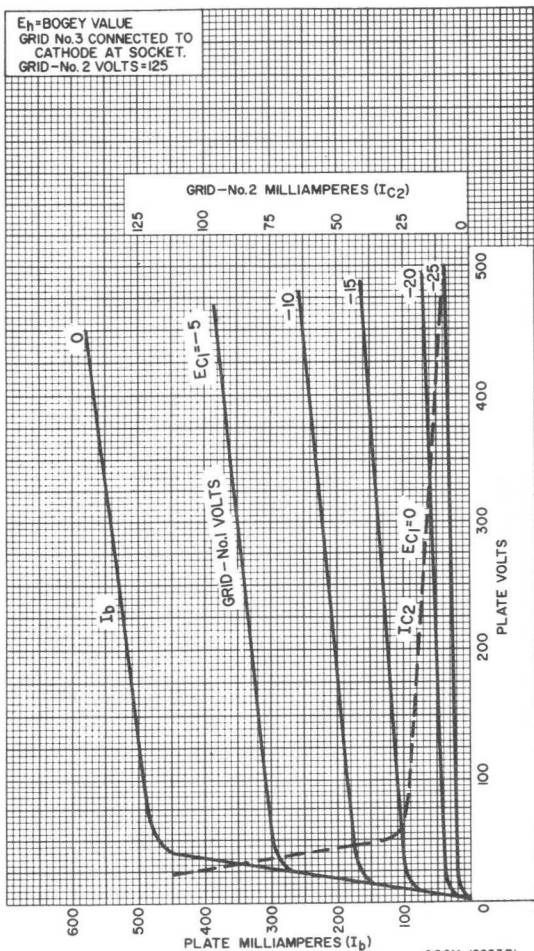

Typical Plate Characteristics

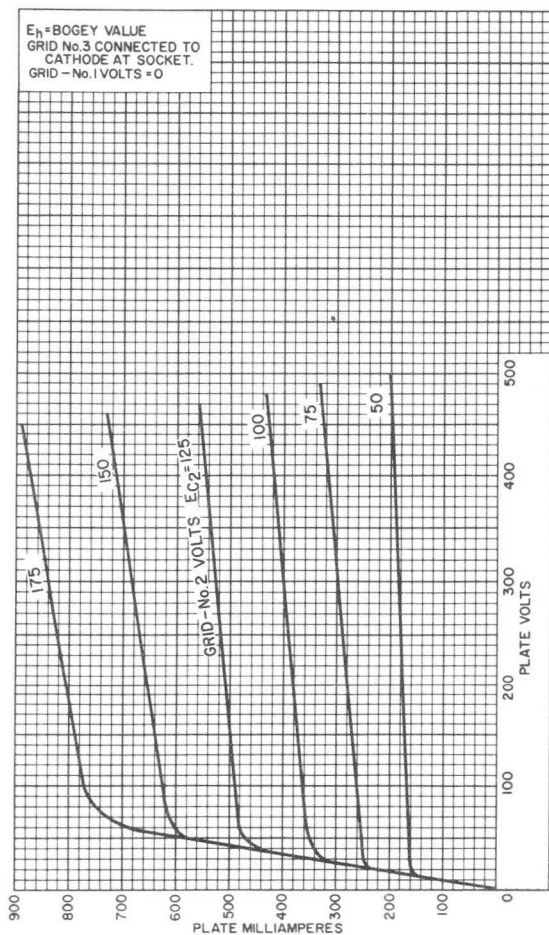

92CM-12652R1



Quadruple Diode

9-PIN MINIATURE TYPE

For Phase-Detector and Noise-Immune Color-Killer Circuits in Color-Television Receivers, and for FM-Stereo-Multiplex Equipment

Electrical:

Heater Characteristics and Ratings:

Voltage (AC or DC)	6.3 ± 0.6	volts
Current at heater volts = 6.3	0.600	amp
Peak heater-cathode voltage (Each unit):		
Heater negative with respect to cathode	300 max.	volts
Heater positive with respect to cathode	300 max.	volts

Direct Interelectrode Capacitances (Approx.):^a

P _{D1} +K _{D2} to K _{D1}	1.8	pf
P _{D1} +K _{D2} to P _{D2}	2.2	pf
P _{D2} to (IS,H)	0.62	pf
P _{D3} +K _{D4} to K _{D3}	1.9	pf
P _{D3} +K _{D4} to P _{D4}	2.2	pf
P _{D4} to (IS,H)	0.94	pf
K _{D1} to (IS,H)	1.8	pf
K _{D3} to (IS,H)	1.9	pf

Mechanical:

Operating Position	Any
Type of Cathodes	Coated Unipotential
Maximum Overall Length	2-3/16"
Maximum Seated Length	1-15/16"
Length, Base Seat to Bulb Top (Excluding tip)	1-9/16" ± 3/32"
Diameter	0.750" to 0.875"
Dimensional Outline	See <i>General Section</i>
Bulb	T6-1/2
Base	Small-Button Noval 9-Pin (JEDEC No. E9-1)
Basing Designation for BOTTOM VIEW	9PQ

- Pin 1 - Plate of Unit No. 4
- Pin 2 - Plate of Unit No. 3,
Cathode of Unit No. 4
- Pin 3 - Cathode of Unit No. 3
- Pin 4 - Heater
- Pin 5 - Heater
- Pin 6 - Internal Shield
- Pin 7 - Plate of Unit No. 2
- Pin 8 - Plate of Unit No. 1,
Cathode of Unit No. 2
- Pin 9 - Cathode of Unit No. 1

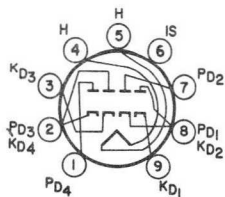

6JU8A

Maximum Ratings, Design-Maximum Values:

Values are for Each Unit

Peak Inverse Plate Voltage.	300 max.	volts
Peak Plate Current.	54 max.	ma
DC Output Current	9 max.	ma

Characteristics, Instantaneous Value:

Values are for Each Unit

Plate Current for plate volts = 10	60	ma
--	----	----

^a Without external shield.

ARRANGEMENT OF DIODE UNITS

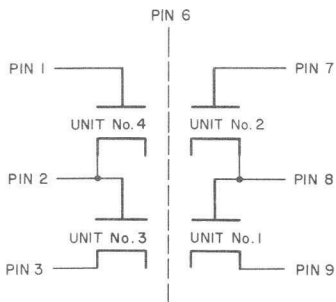

92CS-11532R1



High-Mu Triode— Sharp-Cutoff Pentode

9-PIN MINIATURE TYPE

For Sound-IF, Keyed-AGC, Sync-Separator, Sync-Amplifier,
Noise-Suppression Circuits, and Video Amplifier Service

GENERAL DATA

Electrical:

Heater Characteristics and Ratings:

Voltage (AC or DC)	6.3 ^a	6.3 ± 0.6	volts
Current	0.600 ± 0.040	0.600 ^b	amp
Warm-up time (Average)	11	—	sec

Peak heater-cathode voltage (Each unit):

Heater negative with respect to cathode	200 max.	volts
Heater positive with respect to cathode	200 ^c max.	volts

Direct Interelectrode Capacitances:^d

Triode Unit:

Grid to plate	2.2	pf
Grid to cathode and heater	3.0	pf
Plate to cathode and heater	2.0	pf

Pentode Unit:

Grid No.1 to plate	0.08 max.	pf
Grid No.1 to cathode & grid No.3 & internal shield, grid No.2 and heater	8.0	pf
Pentode plate to pentode cathode & grid No.3 & internal shield, grid No.2 and heater	3.2	pf
Pentode grid No.1 to triode plate	0.012 max.	pf
Pentode plate to triode plate	0.24 max.	pf

Characteristics, Class A₁ Amplifier:

Triode Unit

Plate Voltage	200	volts
Grid-No.1 Voltage	-2	volts
Amplification Factor	70	
Plate Resistance (Approx.)	17500	ohms
Transconductance	4000	μmhos
Plate Current	4	ma



6JV8

Triode Unit

Grid-No.1 Voltage (Approx.)
for plate $\mu a = 20$ -5 volts

Pentode Unit

Plate Voltage	40	60	125	200	volts
Grid-No.2 Voltage	125	200	125	200	volts
Grid-No.1 Voltage	0	0	-1	-2.9	volts
Plate Resistance (Approx.) -	-	-	100000	150000	ohms
Transconductance	-	-	11500	10700	μ mhos
Plate Current	28 ^e	51 ^e	22	22	ma
Grid-No.2 Current	9 ^e	14 ^e	4	4	ma
Grid-No.1 Voltage (Approx.) for plate $\mu a = 20$	-	-	-5.5	-9	volts

Mechanical:

Operating Position. Any
 Type of Cathodes. Coated Unipotential
 Maximum Overall Length. 2-5/8"
 Maximum Seated Length 2-3/8"
 Length from Base Seat to Bulb Top (Excluding tip) . 2" \pm 3/32"
 Diameter. 0.750" to 0.875"
 Dimensional Outline See *General Section*
 Bulb. T6-1/2
 Base. Small-Button Noval 9-Pin (JEDEC No. E9-1)
 Basing Designation for BOTTOM VIEW. 9DX

- Pin 1 -Triode Cathode
- Pin 2 -Triode Grid
- Pin 3 -Triode Plate
- Pin 4 -Heater
- Pin 5 -Heater
- Pin 6 -Pentode Cathode, Grid No.3, Internal Shield

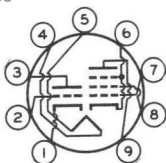

- Pin 7 -Pentode Grid No.1
- Pin 8 -Pentode Grid No.2
- Pin 9 -Pentode Plate

AMPLIFIER —Class A₁

Maximum Ratings, Design-Maximum Values:

	Triode Unit	Pentode Unit	
PLATE VOLTAGE	330 max.	330 max.	volts
GRID-NO.2 (SCREEN-GRID) VOLTAGE	-	330 max.	volts
GRID-NO.1 (CONTROL-GRID) VOLTAGE:			
Negative-bias value	50 max.	50 max.	volts
Positive-bias value	0 max.	0 max.	volts
PLATE DISSIPATION	1.1 max.	4 max.	watts
GRID-NO.2 INPUT	-	1.7 max.	watts



Maximum Circuit Values:

Grid-No.1 Circuit Resistance:

For fixed-bias operation. . .	0.5 max.	0.25 max.	megohm
For cathode-bias operation	1 max.	1 max.	megohm

a At heater amperes = 0.600.

b At heater volts = 6.3.

c The dc component must not exceed 100 volts.

d Without external shield.

e This value can be measured by a method involving a recurrent waveform such that the maximum ratings of the tube will not be exceeded.



6JV8

AVERAGE PLATE CHARACTERISTICS Triode Unit

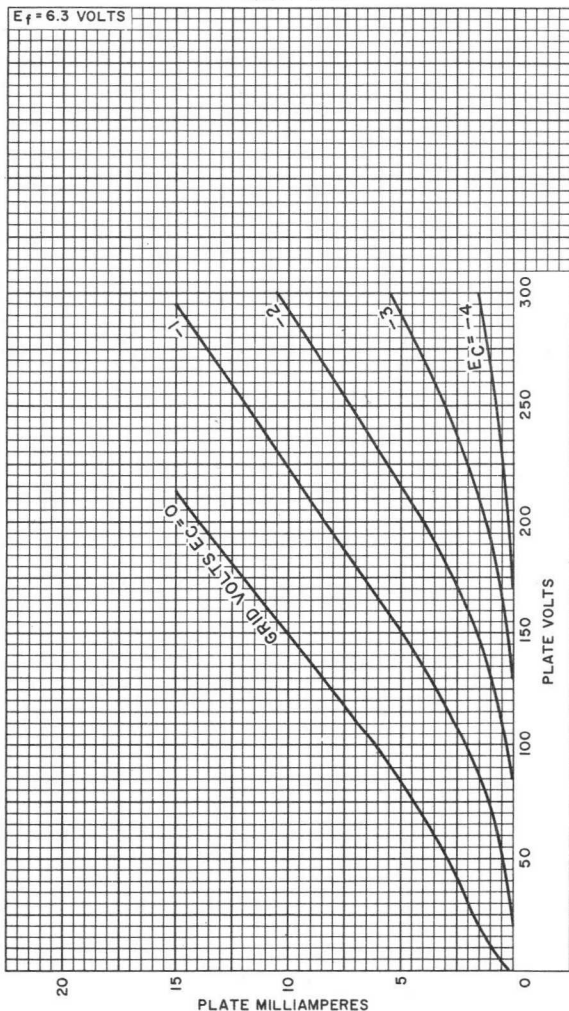

92CM-11960



AVERAGE CHARACTERISTICS Pentode Unit

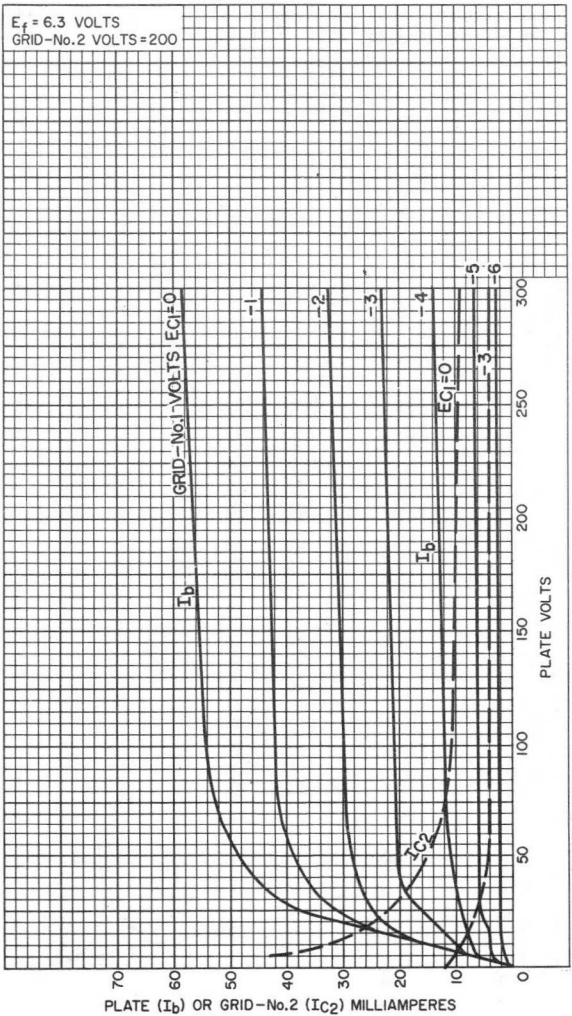

92CM-11961



6JV8

AVERAGE CHARACTERISTICS Pentode Unit

$E_f = 6.3$ VOLTS
GRID - No.2 VOLTS = 125

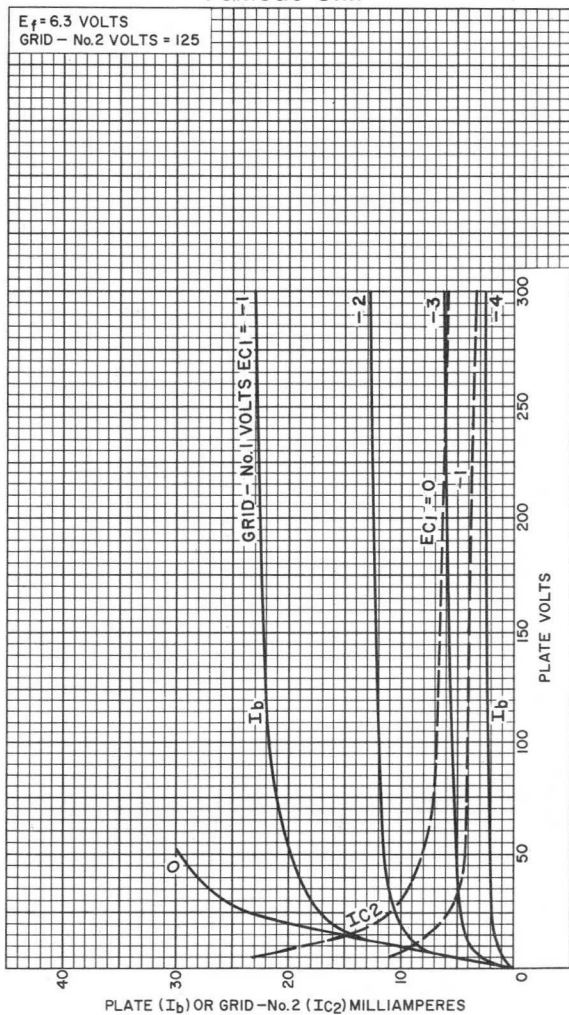

92CM - 11962



Medium-Mu Triode— Beam Power Tube

DUODECAR TYPE

Electrical:

Heater Characteristics and Ratings:

Voltage (AC or DC)	6.3 ± 0.6	volts
Current at heater volts = 6.3	1.200	amp
Peak heater-cathode voltage (Each unit):		
Heater negative with respect to cathode	200	max. volts
Heater positive with respect to cathode	200 ^a	max. volts

Direct Interelectrode Capacitances (Approx.):^b

Triode Unit:

G _T to P _T	3.6	pf
Input: G _T to (K _T , H)	2.2	pf
Output: P _T to (K _T , H)	0.7	pf

Beam Power Unit:

G _{1B} to P _B	0.34	pf
Input: G _{1B} to (K _B +G _{3B} , G _{2B} , H)	11.0	pf
Output: P _B to (K _B +G _{3B} , G _{2B} , H)	7.0	pf

Mechanical:

Operating Position	Any
Types of Cathodes	Coated Unipotential
Maximum Overall Length	2.375"
Seated Length	1.750" to 2.000"
Diameter	1.062" to 1.188"
Dimensional Outline	See <i>General Section</i>
Bulb	T9
Base	Small-Button Duodecar 12-Pin (JEDEC No. E12-70)
Basing Designation for BOTTOM VIEW	12Z2

- Pin 1—Heater
- Pin 2—Triode Plate
- Pin 3—No Internal Connection
- Pin 4—Beam Power Plate
- Pin 5—Same as Pin 3
- Pin 6—Beam Power Grid No.1
- Pin 7—Beam Power Grid No.1
- Pin 8—Beam Power Grid No.2
- Pin 9—Beam Power Cathode,
Beam Power Grid No.3
- Pin 10—Triode Grid
- Pin 11—Triode Cathode
- Pin 12—Heater

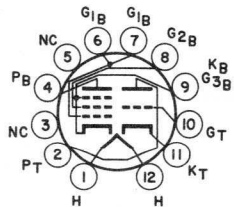

Characteristics, Class A₁ Amplifier:

	Triode Unit	Beam Power Tube		
Plate Voltage	150	45	120	volts
Grid-No.2 Voltage	—	110	110	volts
Grid-No.1 Voltage	-5	0	-8	volts
Amplification Factor	20	—	—	



6JZ8

	Triode Unit	Beam Power Tube	
Plate Resistance (Approx.)	8500	- 1700	ohms
Transconductance.	2350	- 1400	μ hos
Plate Current	5.5	122 46	ma
Grid-No.2 Current	-	16.5 3.5	ma
Grid-No.1 Voltage (Approx.) for plate $\mu a=10$	-11	- -	volts
100.	-	- -25	volts

VERTICAL-DEFLECTION OSCILLATOR

Triode Unit

Maximum Ratings, Design-Maximum Values:

For operation in a 525-line, 30-frame system^c

DC Plate Voltage.	250 max.	volts
Peak Negative Pulse-Grid Voltage.	400 max.	volts
Cathode Current:		
Peak.	70 max.	ma
Average	20 max.	ma
Plate Dissipation	1 max.	watt

Maximum Circuit Values:

Grid-Circuit Resistance:

For fixed-bias operation.	1 max.	megohm
For cathode-bias operation.	2.2 max.	megohms

VERTICAL-DEFLECTION AMPLIFIER

Beam Power Unit

Maximum Ratings, Design-Maximum Values:

For operation in a 525-line, 30-frame system^c

DC Plate Voltage.	250 max.	volts
Peak Positive-Pulse Plate Voltage	2000 max.	volts
Grid No.2 Voltage	200 max.	volts
Cathode Current:		
Peak.	245 max.	ma
Average	70 max.	ma
Plate Dissipation ^d	7 max.	watts
Grid-No.2 Input	1.8 max.	watts

Maximum Circuit Values:

Grid-Circuit Resistance:

For fixed-bias operation.	1 max.	megohm
For cathode-bias operation.	2.2 max.	megohms

^a The dc component must not exceed 100 volts.

^b Without external shield.

^c This rating is applicable where the duration of the voltage pulse does not exceed 15 per cent of one vertical scanning cycle. In a 525-line, 30-frame system, 15 per cent of one vertical scanning cycle is 2.5 milli-seconds.

^d In stages operating with grid-leak bias, an adequate cathode-bias resistor or other suitable means is required to protect the tube in the absence of excitation.





6K6-GT

6K6-GT

POWER PENTODE

GENERAL DATA

Electrical:

Heater, for Unipotential Cathode:

Voltage 6.3 ac or dc volts

Current 0.4 amp

Direct Interelectrode Capacitances (Approx.):^o

Grid No.1 to plate. 0.5 $\mu\mu\text{f}$

Grid No.1 to cathode & grid No.3,
grid No.2, and heater 5.5 $\mu\mu\text{f}$

Plate to cathode & grid No.3,
grid No.2, and heater 6 $\mu\mu\text{f}$

Mechanical:

Mounting Position Any

Maximum Overall Length 3-5/16"

Maximum Seated Length 2-3/4"

Maximum Diameter 1-9/32"

Dimensional Outline See General Section

Bulb T-9

Base Intermediate-Shell Octal 7-Pin (JETEC No. B7-7),
Short Intermediate-Shell Octal 7-Pin
with External Barriers (JETEC No. B7-59),
Intermediate-Shell Octal 6-Pin (JETEC No. B6-81),
or Short Intermediate-Shell Octal 6-Pin
with External Barriers (JETEC No. B6-84)

Basing Designation for BOTTOM VIEW 7S

Pin 1 \blacklozenge - No Connection

Pin 2 - Heater

Pin 3 - Plate

Pin 4 - Grid No.2

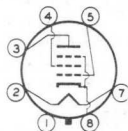

Pin 5 - Grid No.1

Pin 7 - Heater

Pin 8 - Cathode,
Grid No.3

AF POWER AMPLIFIER - Class A₁

Maximum Ratings, Design-Center Values:

PLATE VOLTAGE 315 max. volts

GRID-No.2 (SCREEN-GRID) VOLTAGE 285 max. volts

GRID-No.1 (CONTROL-GRID) VOLTAGE:

Positive bias value 0 max. volts

GRID-No.2 INPUT 2.8 max. watts

PLATE DISSIPATION 8.5 max. watts

PEAK HEATER-CATHODE VOLTAGE:

Heater negative with respect to cathode 200 max. volts

Heater positive with respect to cathode 200[▲] max. volts

^o Without external shield.

\blacklozenge Pin 1 as well as pin 6 is omitted on the 6-Pin bases.

[▲]: See next page.

← Indicates a change.

6K6-GT



6K6-GT

POWER PENTODE

Typical Operation and Characteristics:

Plate Voltage	100	250	315	volts
Grid-No.2 Voltage	100	250	250	volts
Grid-No.1 Voltage	-7	-18	-21	volts
Peak AF Grid-No.1 Voltage . .	7	18	21	volts
Zero-Signal Plate Current . .	9	32	25.5	ma
Max.-Signal Plate Current . .	9.5	33	28	ma
Zero-Signal Grid-No.2 Current	1.6	5.5	4	ma
Max.-Signal Grid-No.2 Current	3	10	9	ma
Plate Resistance (Approx.) . .	104000	90000	110000	ohms
Transconductance	1500	2300	2100	μmhos
Load Resistance	12000	7600	9000	ohms
Total Harmonic Distortion . .	11	11	15	%
Max.-Signal Power Output . . .	0.35	3.4	4.5	watts

Maximum Circuit Values:

Grid-No.1-Circuit Resistance:

For fixed-bias operation	0.1 max.	megohm
For cathode-bias operation	0.5 max.	megohm

PUSH-PULL AF POWER AMPLIFIER - Class A₁

Maximum Ratings, Design-Center Values:

PLATE VOLTAGE	315 max.	volts
GRID-No.2 (SCREEN-GRID) VOLTAGE	285 max.	volts
GRID-No.1 (CONTROL-GRID) VOLTAGE:		
Positive bias value	0 max.	volts
GRID-No.2 INPUT	2.8 max.	watts
PLATE DISSIPATION	8.5 max.	watts
→ PEAK HEATER-CATHODE VOLTAGE:		
Heater negative with respect to cathode.	200 max.	volts
Heater positive with respect to cathode.	200 [▲] max.	volts

Typical Operation:

Values are for 2 tubes

	Fixed Bias	Cathode Bias	
Plate Voltage	285	285	volts
Grid-No.2 Voltage	285	285	volts
Grid-No.1 Voltage	-25.5	-	volts
Cathode Resistor	-	400	ohms
Peak AF Grid-No.1-to-			
Grid-No.1 Voltage	51	51	volts
Zero-Signal Plate Current . .	55	55	ma
Max.-Signal Plate Current . .	72	61	ma
Zero-Signal Grid-No.2 Current	9	9	ma
Max.-Signal Grid-No.2 Current	17	13	ma

▲: See next page.

→ Indicates a change.



6K6-GT

6K6-GT

POWER PENTODE

	Fixed Bias	Cathode Bias	
Effective Load Resistance (Plate to plate)	12000	12000	ohms
Total Harmonic Distortion . . .	6	4	%
Max.-Signal Power Output.	10.5	9.8	watts

Maximum Circuit Values:

Grid-No.1-Circuit Resistance:			
For fixed-bias operation.		0.1 max.	megohm
For cathode-bias operation.		0.5 max.	megohm

AF POWER AMPLIFIER - Class A₁

Triode Connection - Grid No.2 Connected to Plate

Characteristics:

Plate Voltage	250	volts
Grid-No.1 Voltage	-18	volts
Amplification Factor.	6.8	
Plate Resistance (Approx.)	2500	ohms
Transconductance.	2700	μmhos
Plate Current	37.5	ma
Grid-No.1 Voltage (Approx.) for plate current of 0.5 ma	-48	volts

VERTICAL DEFLECTION AMPLIFIER

Triode Connection - Grid No.2 Connected to Plate

Maximum Ratings, Design-Center Values Except as Noted:

For operation in a 525-line, 30-frame system[□]

DC PLATE VOLTAGE.	315 max.	volts
PEAK POSITIVE-PULSE PLATE VOLTAGE (Absolute maximum) [#]	1200 [■] max.	volts
PEAK NEGATIVE-PULSE GRID-No.1 VOLTAGE . . .	-250 max.	volts
CATHODE CURRENT:		
Peak.	75 max.	ma
Average	25 max.	ma
PLATE DISSIPATION	7 max.	watts
PEAK HEATER-CATHODE VOLTAGE:		
Heater negative with respect to cathode.	200 max.	volts
Heater positive with respect to cathode.	200 [▲] max.	volts

Maximum Circuit Values:

Grid-No.1-Circuit Resistance:		
For cathode-bias operation.	2.2 max.	megohms

[▲] The dc component must not exceed 100 volts.

[□] As described in "Standards of Good Engineering Practice Concerning Television Broadcast Stations", Federal Communications Commission.

[#] This rating is applicable where the duration of the voltage pulse does not exceed 15 per cent of one vertical scanning cycle. In a 525-line, 30-frame system, 15 percent of one vertical scanning cycle is 2.5 milliseconds.

[■] Under no circumstances should this absolute value be exceeded.

← Indicates a change.

6K6-GT



6K6-GT

AVERAGE CHARACTERISTICS

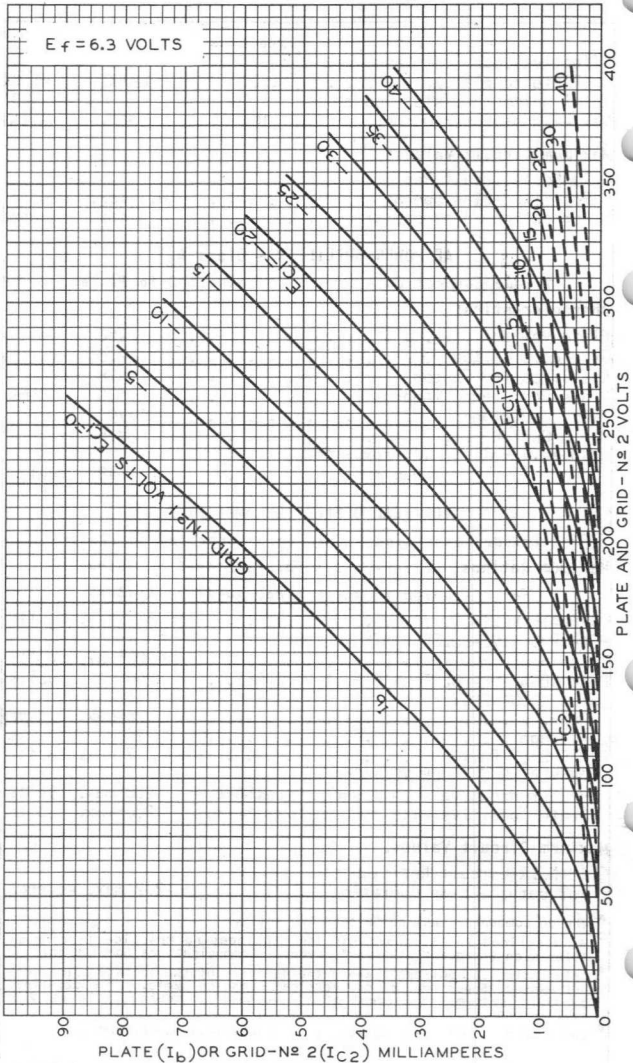

TUBE DIVISION

92CM-5209R2

RADIO CORPORATION OF AMERICA, HARRISON, NEW JERSEY



6K6-GT

6K6-GT

AVERAGE PLATE CHARACTERISTICS PENTODE CONNECTION

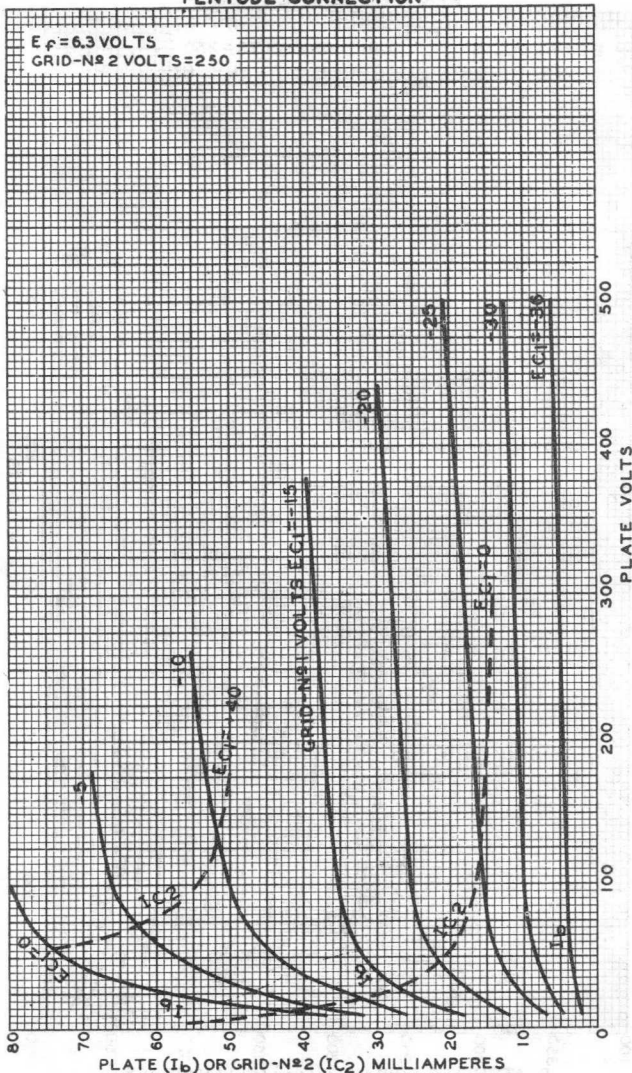

FEB. 13, 1948

TUBE DEPARTMENT

92CM-4891R2

RADIO CORPORATION OF AMERICA, HARRISON, NEW JERSEY

6K6-GT



6K6-GT

AVERAGE PLATE CHARACTERISTICS PENTODE CONNECTION

$E_f = 6.3$ VOLTS

GRID - N^o2 VOLTS = 250

GRID - N^o1 (I_{C1}) MILLIAMPERES

75 50 25 0

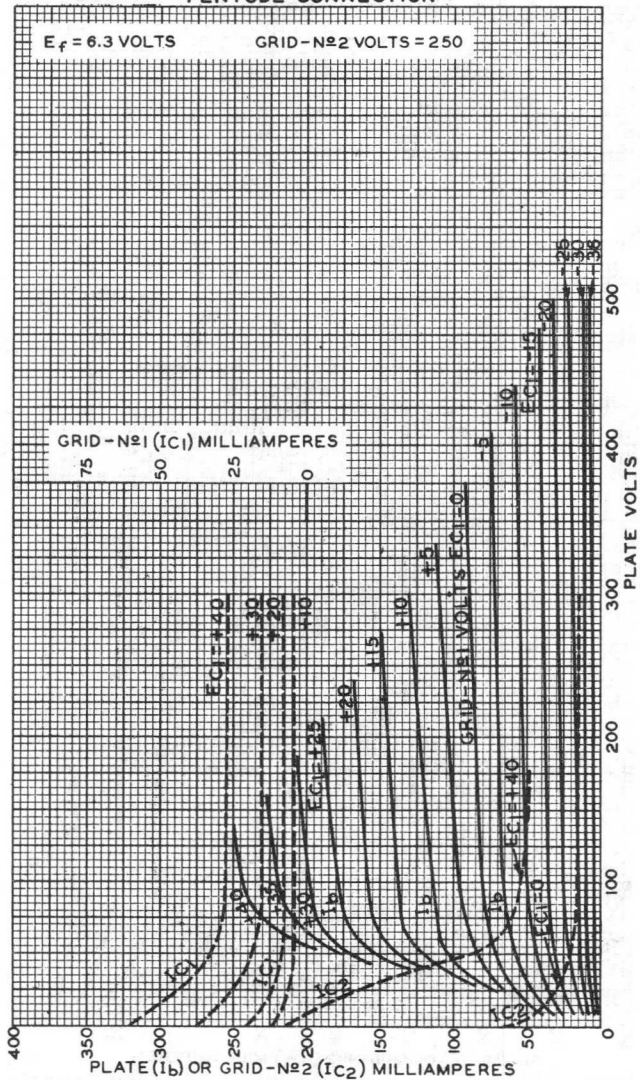

PLATE (I_b) OR GRID - N^o2 (I_{C2}) MILLIAMPERES

FEB. 13, 1948

TUBE DEPARTMENT
RADIO CORPORATION OF AMERICA, HARRISON, NEW JERSEY

92CM-6311R1



6K6-GT

6K6-GT AVERAGE PLATE CHARACTERISTICS TRIODE CONNECTION

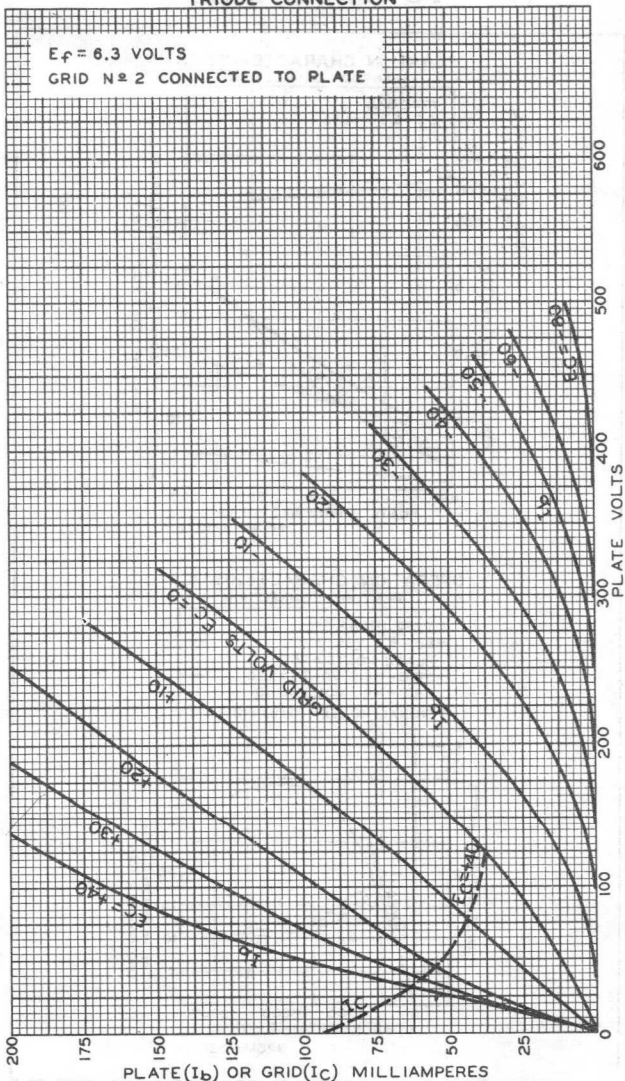

AUG. 18, 1941

TUBE DEPARTMENT
RADIO CORPORATION OF AMERICA, HARRISON, NEW JERSEY

92CM-6313

6K6-GT



6K6-GT POWER PENTODE

OPERATION CHARACTERISTICS
PENTODE CONNECTION

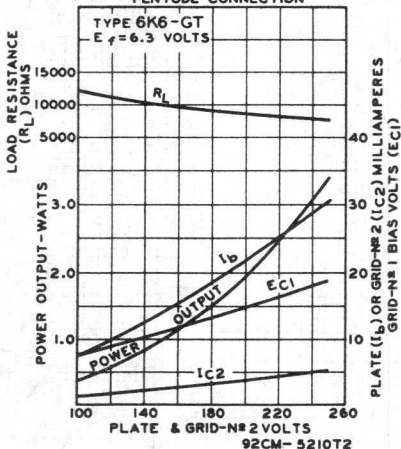

OPERATION CHARACTERISTICS
PENTODE CONNECTION

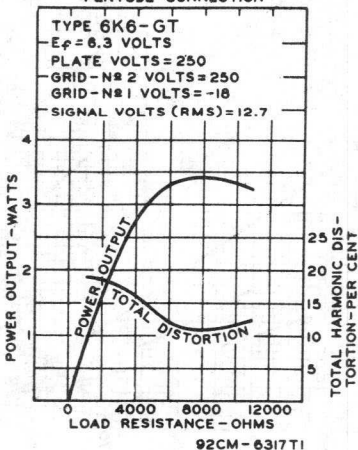

Three-Unit Triode

With Medium-Mu Unit and Two High-Mu Units

DUODECAR TYPE

Electrical:

Heater Characteristics and Ratings:

Voltage (AC or DC)	6.3 ^a	6.3 ± 0.6	volts
Current	0.600 ± 0.040	0.600 ^b	amp
Warm-up time (Average)	11	-	sec
Peak heater-cathode voltage (Each unit):			

Heater negative with respect to cathode 200 max. volts

Heater positive with respect to cathode 200^c max. volts

Direct Interelectrode Capacitances (Approx.):^d

	Unit No. 1	Unit No. 2	Unit No. 3	
Grid to plate	1.3	1.3	1.3	pf
Input: G to (K, IS, H)	1.9	1.8	1.8	pf
Output: P to (K, IS, H)	1.8	0.7	1.8	pf

Mechanical:

Operating Position	Any
Type of Cathodes	Coated Unipotential
Maximum Overall Length	1.875"
Seated Length	1.250" to 1.500"
Diameter	1.062" to 1.188"
Dimensional Outline (JEDEC 9-56)	See General Section
Bulb	T9
Base	Small-Button Duodecar 12-Pin (JEDEC No. E12-70)
Basing Designation for BOTTOM VIEW12BY

- Pin 1 - Heater
- Pin 2 - Plate of Unit No. 3
- Pin 3 - Cathode of Unit No. 3
- Pin 4 - Cathode of Unit No. 1
- Pin 5 - Plate of Unit No. 2
- Pin 6 - Cathode of Unit No. 2
- Pin 7 - Grid of Unit No. 2
- Pin 8 - Internal Shield
- Pin 9 - Grid of Unit No. 1
- Pin 10 - Plate of Unit No. 1
- Pin 11 - Grid of Unit No. 3
- Pin 12 - Heater

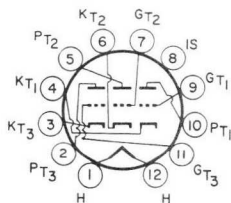

AMPLIFIER — Class A₁

Unit	Unit No.
No. 1	2 or 3

Characteristics:

Plate Voltage	250	250	volts
Grid Voltage	-8.5	-2	volts



6K11/6Q11

	Unit No. 1	Unit No. 2 or 3	
Amplification Factor.	17	100	
Plate Resistance (Approx.). . .	7700	62500	ohms
Transconductance.	2200	1600	μ mhos
Plate Current	10.5	1.2	ma
Grid Voltage (Approx.) for plate μ a = 10	-24	-	volts

Maximum Ratings, Design-Maximum Values:

Plate Voltage	330	330	volts
Grid Voltage:			
Negative-bias value	50	50	volts
Positive-bias value	0	0	volts
Cathode Current	20		ma
Plate Dissipation	2.75	0.3	watts

- a At heater amperes = 0.600.
- b At heater volts = 6.3
- c The dc component must not exceed 100 volts.
- d without external shield.



High-Mu Triode—Sharp-Cutoff Pentode Pentode Unit Has Two Independent Control Grids

9-PIN MINIATURE TYPE

With Heater Having Controlled Warm-Up Time

GENERAL DATA

Electrical:

Heater Characteristics and Ratings (*Design-Maximum Values*):

Voltage (AC or DC)	6.3 ^a	6.3 ± 0.6	volts
Current	0.600 ± 0.040	0.600 ^b	amp
Warm-up time (Average)	11	-	sec

Peak heater-cathode
voltage:

Heater negative with respect to cathode	200	max.	volts
Heater positive with respect to cathode	200 ^c	max.	volts

Direct Interelectrode Capacitances:^d

Triode Unit:

Grid to plate	2.2	μf
Grid to cathode & internal shield, and heater	2.8	μf
Plate to cathode & internal shield, and heater	2.2	μf

Pentode Unit:

Grid No.1 to plate	0.1	max.	μf
Grid No.1 to cathode & internal shield, grid No.3, grid No.2, and heater	9.5		μf
Grid No.1 to grid No.3	0.5		μf
Grid No.3 to plate	2.2		μf
Grid No.3 to cathode & internal shield, plate, grid No.2, grid No.1, and heater	7.0.		μf

Characteristics, Class A₁ Amplifier:

	Triode Unit	Pentode Unit	
Plate Supply Voltage	200	150	volts
Grid-No.3 Supply Voltage	-	0	volts
Grid-No.2 Supply Voltage	-	100	volts
Grid-No.1 Supply Voltage	-2	0	volts
Cathode Resistor	-	180	ohms
Amplification Factor	70	-	
Plate Resistance (Approx.)	17500	100000	ohms
Transconductance, Grid No.1 to Plate	4000	4400	μmhos
Transconductance, Grid No.3 to Plate	-	600	μmhos



6KA8

Plate Current.	4	4	ma
Grid-No.2 Current.	-	2.8	ma
Grid-No.1 Supply Voltage (Approx.) for plate μ =			
10	-5	-	volts
20	-	-4	volts
Grid-No.3 Supply Voltage (Approx.) for plate μ = 20.	-	-7	volts

Mechanical:

Operating Position	Any
Type of Cathode.	Coated Unipotential
Maximum Overall Length	2-5/8"
Maximum Seated Length.	2-3/8"
Length, Base Seat to Bulb Top (Excluding tip).	2" \pm 3/32"
Diameter	0.750" to 0.875"
Dimensional Outline.	See <i>General Section</i>
Bulb	T6-1/2
Base	Small-Button Noval 9-Pin (JEDEC No.E9-1)
Basing Designation for BOTTOM VIEW9PV

- Pin 1 - Triode Plate
- Pin 2 - Triode Grid
- Pin 3 - Cathode, Internal Shield
- Pin 4 - Heater
- Pin 5 - Heater

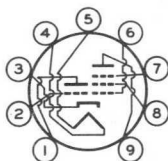

- Pin 6 - Pentode Grid No.1
- Pin 7 - Pentode Grid No.3
- Pin 8 - Pentode Grid No.2
- Pin 9 - Pentode Plate

GATED AGC AMPLIFIER & NOISE INVERTER

Pentode Unit

For operation in a 525-line, 30-frame system^e

Maximum Ratings, Design-Maximum Values:

PLATE VOLTAGE.	300 max.	volts
PEAK POSITIVE-PULSE PLATE VOLTAGE ^f	600 max.	volts
GRID-No.3 (CONTROL-GRID) VOLTAGE:		
Negative-bias value.	100 max.	volts
Positive-bias value.	0 max.	volts
GRID-No.2 (SCREEN-GRID)		
SUPPLY VOLTAGE	300 max.	volts
GRID-No.2 VOLTAGE.	See <i>Grid-No.2 Input Rating Chart</i> at front of Receiving Tube Section	
GRID-No.1 (CONTROL-GRID) VOLTAGE:		
Negative-bias value.	50 max.	volts
Positive-bias value.	0 max.	volts
GRID-No.2 INPUT:		
For grid-No.2 voltages up to 150 volts.	1.1 max.	watts



For grid-No.2 voltages
between 150 volts and
300 volts. See *Grid-No.2 Input Rating Chart*
at front of Receiving Tube Section

PLATE DISSIPATION. 2 max. watts

Maximum Circuit Values:

Grid-No.3-Circuit Resistance 0.68 max. megohm
Grid-No.1-Circuit Resistance:
For fixed-bias operation 0.5 max. megohm
For cathode-bias operation 1 max. megohm

AMPLIFIER — Class A₁

Triode Unit

Maximum Ratings, Design-Maximum Values:

PLATE VOLTAGE. 300 max. volts
GRID VOLTAGE:
Negative-bias value. 50 max. volts
Positive-bias value. 0 max. volts
PLATE DISSIPATION. 1.1 max. watts

Maximum Circuit Values:

Grid-Circuit Resistance:
For fixed-bias operation 0.25 max. megohm
For cathode-bias operation 1 max. megohm

- a At heater amperes = 0.600.
- b At heater volts = 6.3.
- c The dc component must not exceed 100 volts.
- d Without external shield.
- e As described in "Standards of Good Engineering Practice Concerning Television Broadcast Stations," Federal Communications Commission.
- f This rating is applicable when the duration of the voltage pulse does not exceed 15 per cent of one horizontal scanning cycle. In a 525-line, 30-frame system, 15 per cent of one horizontal scanning cycle is 10 microseconds.



6KA8

AVERAGE PLATE CHARACTERISTICS Triode Unit

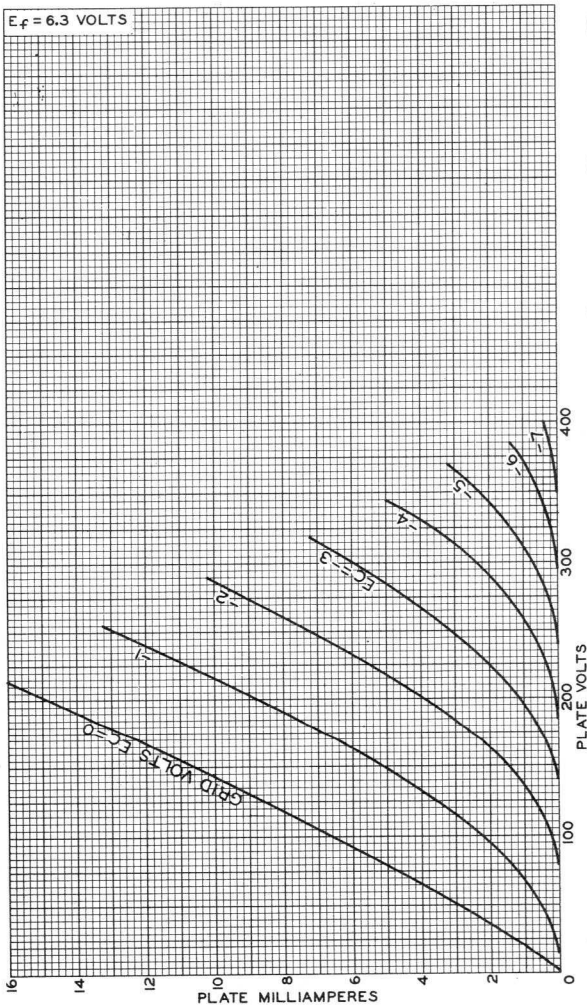

92CM-8644

RADIO CORPORATION OF AMERICA
Electron Tube Division

Harrison, N. J.



AVERAGE CHARACTERISTICS Triode Unit

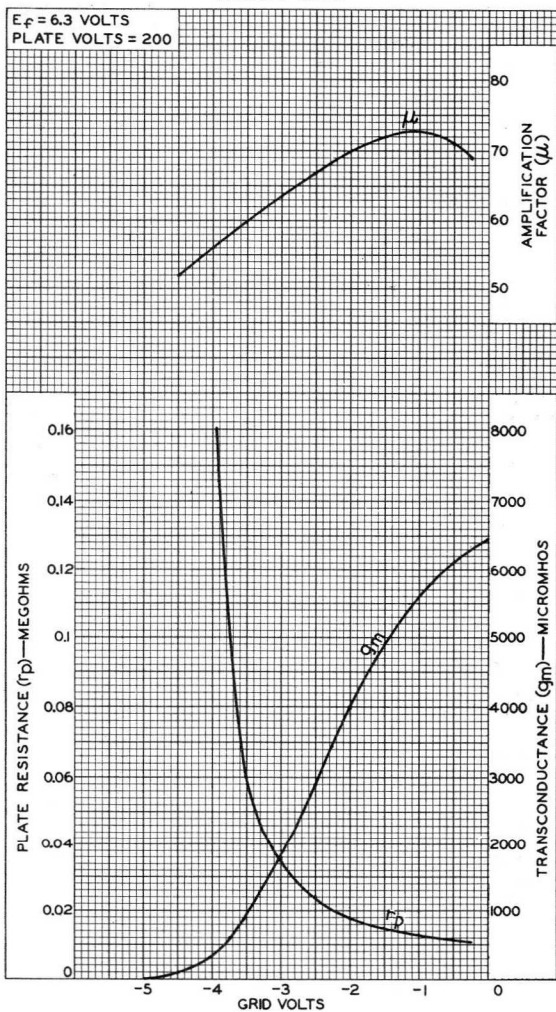

92CM-8647



6KA8

AVERAGE CHARACTERISTICS Pentode Unit

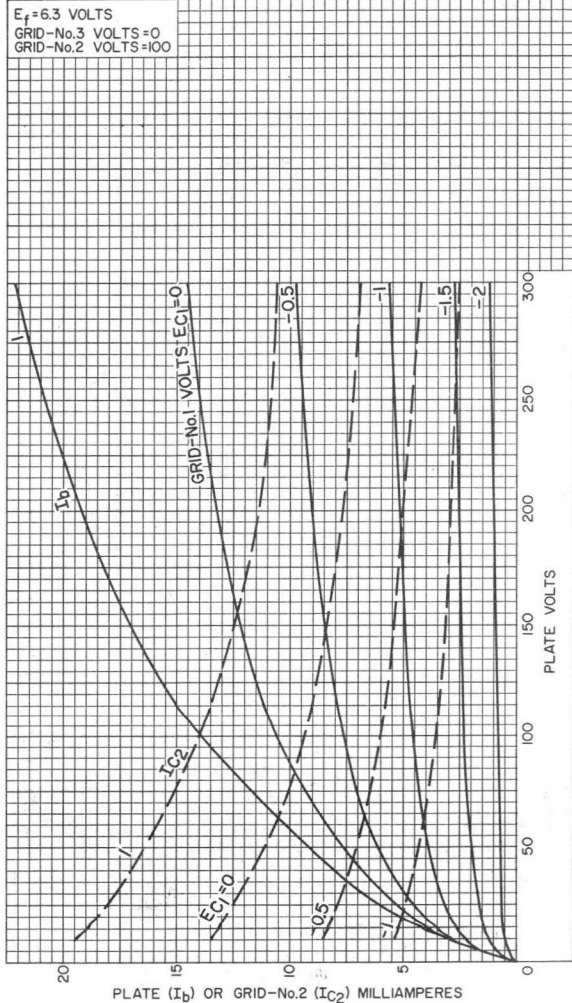

AVERAGE CHARACTERISTICS Pentode Unit

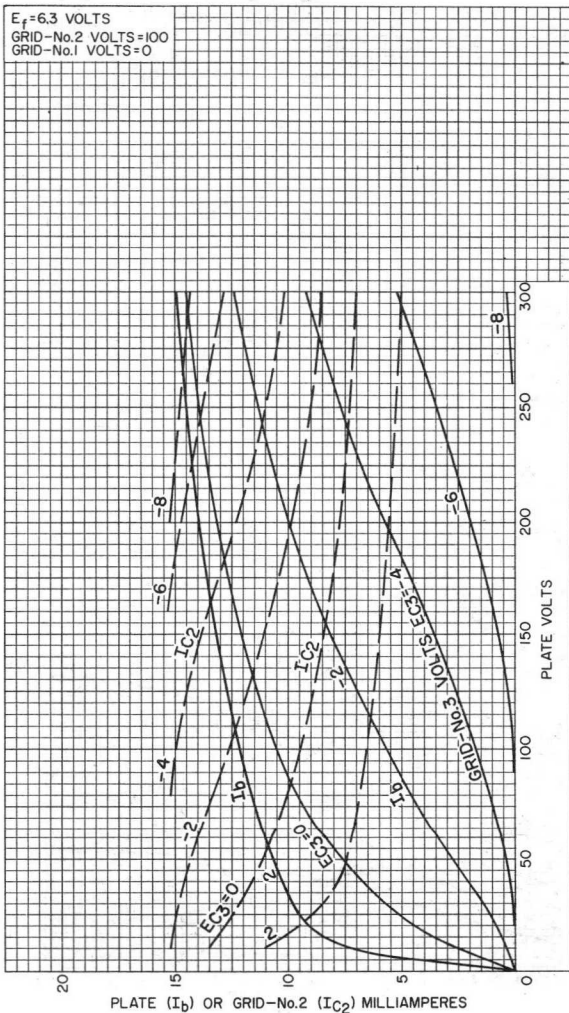

92CM-11606



6KA8

AVERAGE CHARACTERISTICS Pentode Unit

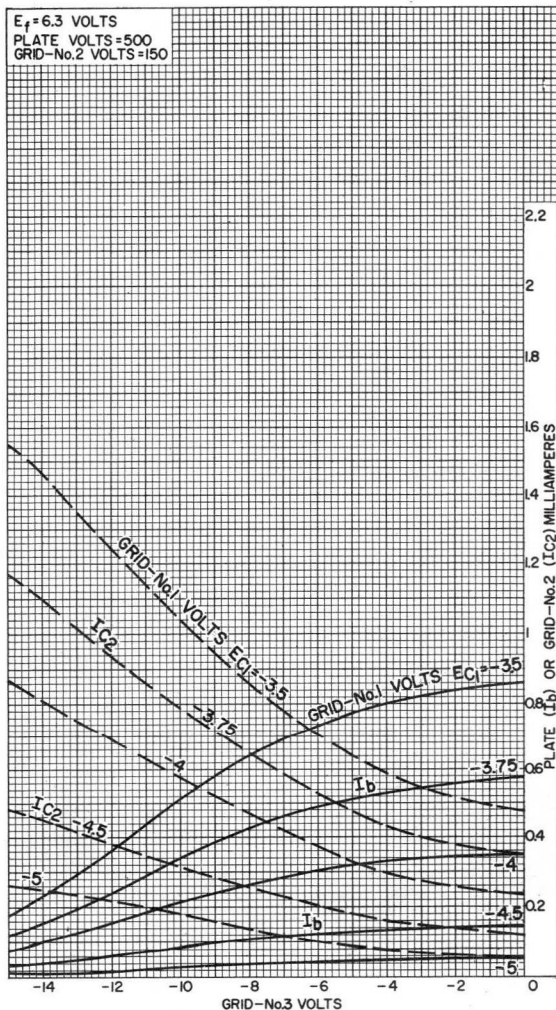

92CM-11600



AVERAGE CHARACTERISTICS Pentode Unit

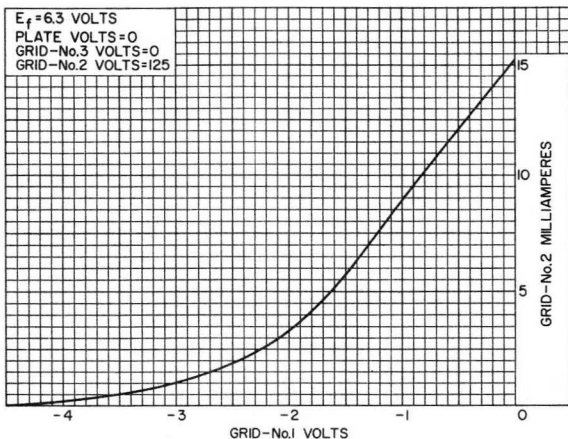

92CS-11603

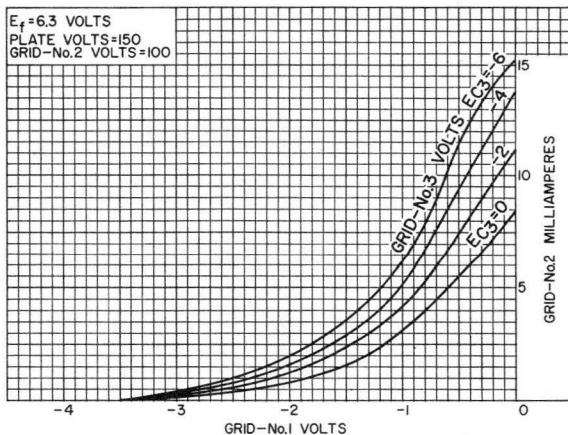

92CS-11596



6KA8

AVERAGE CHARACTERISTICS Pentode Unit

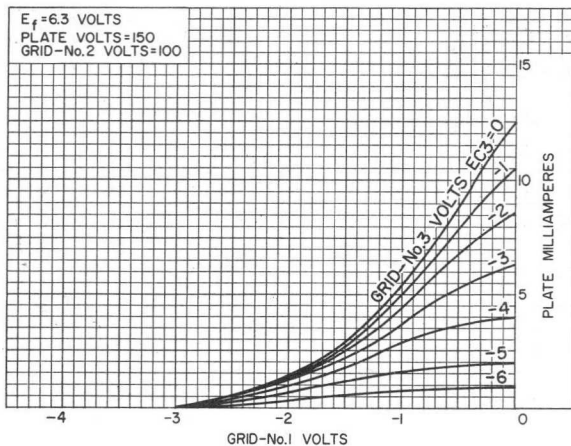

92CS-11614



Beam Power Tube

Duodecar Type

For Low B+ Horizontal-Deflection-Amplifier
Circuits of Color-TV Receivers

ELECTRICAL CHARACTERISTICS - Bogey Values

Heater Voltage, ac or dc.	E_h	6.3	V
Heater Current	I_h	2.85	A
Direct Interelectrode Capacitances (approx.): ^a			
Grid No.1 to plate	c_{g1-p}	0.8	pF
Input: G1 to (K,G3,G2,H)	c_i	40	pF
Output: P to (K,G3,G2,H)	c_o	16	pF

For the following characteristics, see Conditions below:

Amplification Factor

(Triode Connection) ^b	μ	- - -	4 ^c	
Plate Resistance (approx.)	r_p	- - -	6000	Ω
Transconductance	g_m	- - -	14000	μmho
DC Plate Current	I_b	- 1100 ^d 780 ^d	100	mA
DC Grid-No.2 Current	I_{c2}	- 110 ^d 44 ^d	2	mA
Cutoff DC Grid-No.1 Voltage for $I_b = 1 \text{ mA}$	$E_{c1(co)}$	-125 - - -	-40	V

Conditions:

Heater Voltage	E_h	← 6.3 →			V
Peak Positive-Pulse					
Plate Voltage ^e	e_{bm}	5000	- - -		V
DC Plate Voltage	E_b	- 45 60 150			V
DC Grid-No.3 Voltage		Connected to cathode at socket			
DC Grid-No.2 Voltage	E_{c2}	110 160 110 110			V
DC Grid-No.1 Voltage	E_{c1}	- 0 0 -22.5			V

MECHANICAL CHARACTERISTICS

Maximum Overall Length	4.625 in (117.47 mm)
Maximum Seated Length	4.250 in (107.95 mm)
Maximum Diameter	1.563 in (39.7 mm)
Dimensional Outline	JEDEC 12-118
Envelope	JEDEC T12
Top Cap ^f	Small (JEDEC C1-1)
Base	Large-Button Duodecar 12-Pin (JEDEC E12-74)

6KD6

Terminal Diagram JEDEC 12GW
 Type of Cathode Coated Unipotential
 Operating Position Any

MAXIMUM RATINGS – Design-Maximum Values^g

*For operation as a Horizontal-Deflection-Amplifier Tube
 in a 525-line, 30-frame system*

DC Plate Supply Voltage	E_{bb}	990	V
Peak Positive-Pulse Plate Voltage ^h	e_{bm}	7000 ^k	V
DC Grid-No.3 Voltage ^m	E_{c3}	20	V
DC Grid-No.2 (Screen-Grid) Voltage	E_{c2}	200	V
Peak Negative-Pulse Grid-No.1 (Control-Grid) Voltage	$-e_{c1m}$	250	V
Heater-Cathode Voltage:			
Peak	e_{hkm}	±200	V
Average ⁿ	E_{hk}	100	V
Heater Voltage, ac or dc	E_h	5.7 to 6.9	V
Cathode Current:			
Peak	i_{km}	1400	mA
Average ⁿ	$I_{k(av)}$	400	mA
Grid-No.2 Input	P_{g2}	5.0	W
Plate Dissipation ^p	P_b	33	W
Envelope Temperature	T_E	225 ^q	°C

MAXIMUM CIRCUIT VALUES

Grid-No.1-Circuit Resistance	R_{g1}	2.2	MΩ
Grid-No.3-Circuit Resistance	R_{g3}	0.01	MΩ

^a Measured without external shield in accordance with the current issue of EIA Standard RS-191.

^b With grid No.3 and grid No.2 connected, respectively, to cathode and plate at socket.

^c Conditions: $E_b = E_{c2} = 150$ V, $E_{c1} = -22.5$ V.

^d This value can be measured by a method involving a recurrent waveform such that the Maximum Ratings of the tube will not be exceeded.

^e Under pulse-duration condition specified in Footnote h.

^f Designed to mate with connector of 0.250-in ch cap, generally available from your local RCA distributor.

^g As defined in the current issue of EIA Standard RS-239, unless otherwise specified.

- ^h This rating is applicable when the duration of the voltage pulse does not exceed 15% of one horizontal scanning cycle. In a 525-line, 30-frame system, 15% of one horizontal scanning cycle is 10 μ s.
- ^k Absolute-Maximum Value.
- ^m In horizontal-deflection-amplifier service, a positive voltage may be applied to grid No.3 to reduce interference from "snivets," which may occur in both vhf and uhf television receivers. A typical value for this voltage is 20 volts.
- ⁿ Measured with a DC meter.
- ^p An adequate bias resistor or other means is required to protect the tube in the absence of excitation.
- ^q This rating is applicable when measurement is made using a thermocouple attached to a 0.1-inch wide phosphor-bronze ring placed at the hottest location on the envelope. A maximum rating of 240°C is applicable to direct thermocouple measurements taken at the hottest point on the envelope surface.

TERMINAL DIAGRAM (Bottom View)

- Pin 1 – Heater
 Pin 2 – Cathode
 Pin 3 – Grid No.2
 Pin 4 – Grid No.3
 Pin 5 – Grid No.1
 Pin 6 – No Connection
 Pin 7 – Do Not Use
 Pin 8 – No Connection
 Pin 9 – Grid No.1
 Pin 10 – Grid No.3
 Pin 11 – Grid No.2
 Pin 12 – Heater
 Cap – Plate

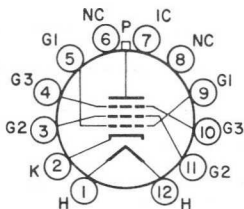

JEDEC 12GW

6KD6

DIMENSIONAL OUTLINE (JEDEC No.12-118)

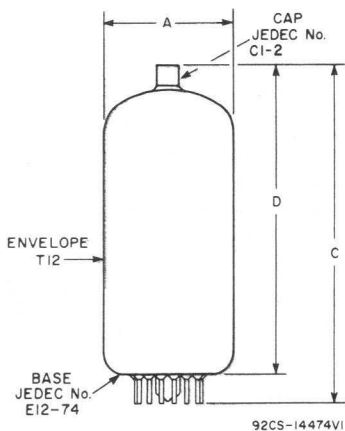

DIMENSION	INCHES		MILLIMETERS	
	Min.	Max.	Min.	Max.
A	1.437*	1.563	36.5*	39.7
C	—	4.625	—	117.47
D	—	4.250	—	107.95

MILLIMETER DIMENSION DERIVED FROM INCH DIMENSION

* Applies to the minimum diameter except in the area of the seal.

Medium-Mu Triode— Sharp-Cutoff Pentode

9-PIN MINIATURE TYPE

FRAME-GRID PENTODE

For Combined Oscillator-Mixer Applications
in TV Receivers Having an IF of 40 Mc

GENERAL DATA

Electrical:

Heater Characteristics and Ratings:

Voltage (AC or DC) 6.3 ± 0.6 volts
Current at heater volts = 6.3 0.400 amp

Peak heater-cathode voltage (Each unit):

Heater negative with
respect to cathode 200 max. volts

Heater positive with
respect to cathode 200^a max. volts

Direct Interelectrode Capacitances:^b*Triode Unit:*

Grid to plate 1.3 pf

Grid to cathode, pentode cathode
& pentode grid No.3 & internal
shield, and heater 2.4 pf

Plate to cathode, pentode cathode
& pentode grid No.3 & internal
shield, and heater 2.0 pf

Pentode Unit:

Grid No.1 to plate 0.015 max. pf

Grid No.1 to cathode & grid No.3
& internal shield, grid No.2,
and heater 5.0 pf

Plate to cathode & grid No.3,
& internal shield, grid No.2,
and heater 3.4 pf

Heater to triode cathode and
pentode cathode 5.5^c pf

Characteristics, Class A₁ Amplifier:

	<i>Triode Unit</i>	<i>Pentode Unit</i>	
Plate Supply Voltage	125	125	volts
Grid-No.2 Supply Voltage	—	125	volts
Cathode Resistor	68	33	ohms
Amplification Factor	40	—	
Plate Resistance (Approx.)	5000	125000	ohms
Transconductance	8000	12000	μmhos
Plate Current	13	10	ma
Grid-No.2 Current	—	2.8	ma



6KE8

Grid-No.1 Voltage (Approx.)

for plate $\mu a =$

100	-5	-	volts
50.	-	-3	volts

Mechanical:

Operating Position.	Any
Type of Cathodes.	Coated Unipotential
Maximum Overall Length.	2-3/16"
Maximum Seated Length	1-15/16"
Length, Base Seat to Bulb Top (Excluding tip).	1-9/16" \pm 3/32"
Diameter.	0.750" to 0.875"
Dimensional Outline	See <i>General Section</i>
Bulb.	T6-1/2
Base.	Small-Button Noval 9-Pin (JEDEC No.E9-1)
Basing Designation for BOTTOM VIEW.	9DC

- Pin 1-Triode Plate
- Pin 2-Pentode
Grid No.1
- Pin 3-Pentode
Grid No.2
- Pin 4-Heater
- Pin 5-Heater
- Pin 6-Pentode Plate

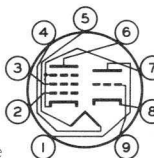

- Pin 7-Pentode
Cathode,
Pentode
Grid No.3,
Internal
Shield
- Pin 8-Triode Cathode
- Pin 9-Triode Grid

AMPLIFIER — Class A₁

Maximum Ratings, Design-Maximum Values:

	Triode Unit	Pentode Unit	
PLATE VOLTAGE	280 max.	280 max.	volts
GRID-No.2 SUPPLY VOLTAGE.	-	280 max.	volts
GRID-No.2 VOLTAGE	-	See <i>Grid-No.2 Input Rating Chart</i> at front of Receiving Tube Section	
GRID-No.1 VOLTAGE:			
Positive-bias value	0 max.	0 max.	volts
CATHODE CURRENT	20 max.	20 max.	ma
GRID-No.2 INPUT:			
For grid-No.2 voltages up to 140 volts	-	0.5 max.	watt
For grid-No.2 voltages between 140 and 280 volts	-	See <i>Grid-No.2 Input Rating Chart</i> at front of Receiving Tube Section	
PLATE DISSIPATION	2 max.	2 max.	watts

Maximum Circuit Values:

	Triode Unit	Pentode Unit	
Grid-No.1-Circuit Resistance:			
For fixed-bias operation.	0.5 max.	0.25 max.	megohm
For cathode-bias operation.	1 max.	0.5 max.	megohm

- a The dc component must not exceed 100 volts.
- b With external shield JEDEC No.315 connected to cathode of unit under test except as noted.
- c With external shield JEDEC No.315 connected to ground.



AVERAGE PLATE CHARACTERISTICS Triode Unit

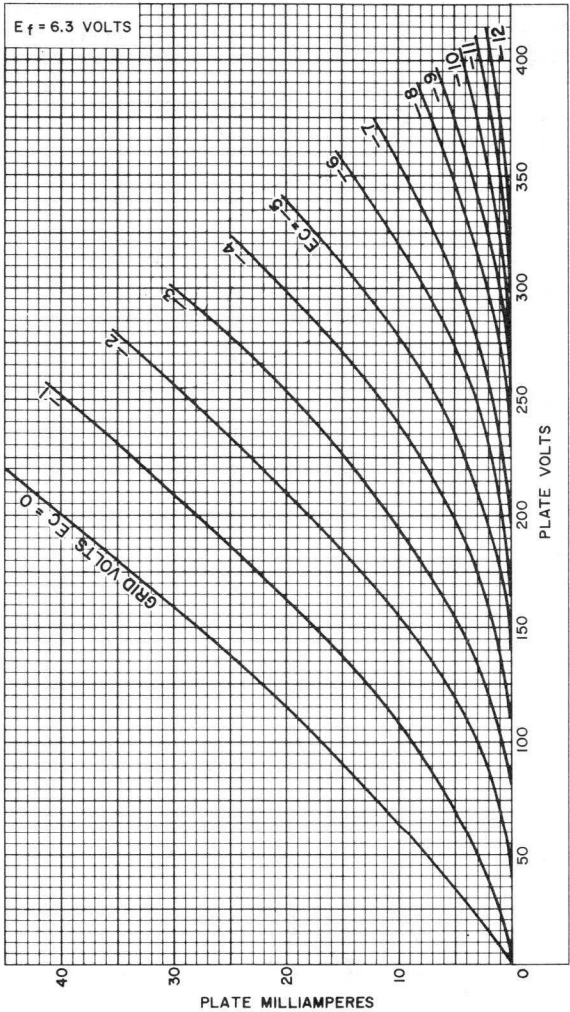

92CM-11897



6KE8

AVERAGE CHARACTERISTICS Triode Unit

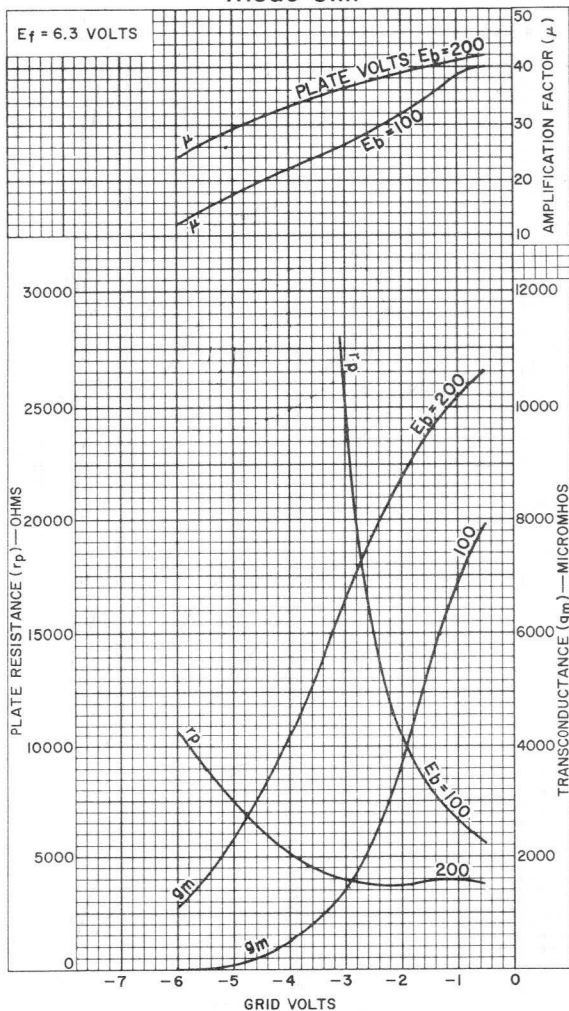

92CM-11901

RADIO CORPORATION OF AMERICA
Electron Tube Division

Harrison, N. J.



AVERAGE CHARACTERISTICS

Pentode Unit

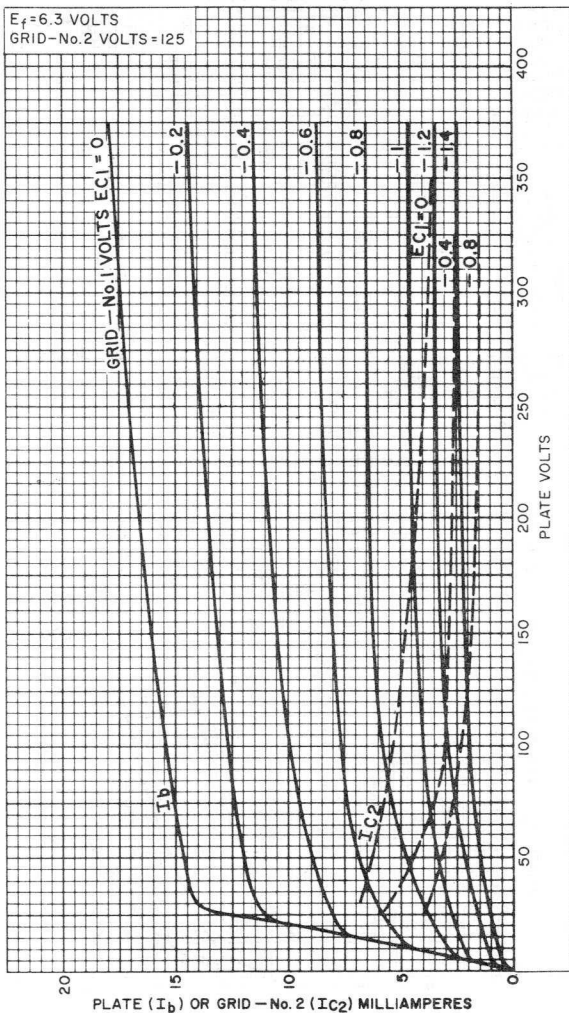

6KE8

AVERAGE CHARACTERISTICS Pentode Unit

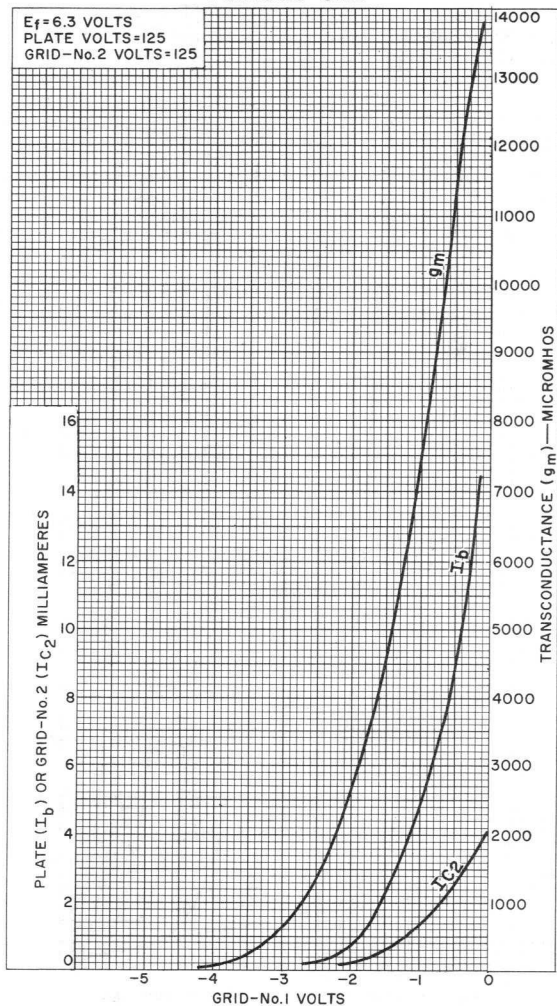

92CM-11902



Beam Power Tube

NOVAR TYPE

SPECIAL MULTIPLE-FIN PLATE STRUCTURE^a
SPECIALLY FORMULATED ENVELOPE GLASS^b

For Color-TV Horizontal-Deflection-Amplifier Applications

ELECTRICAL

Heater Characteristics and Ratings

Voltage (AC or DC)	6.3 ± 0.6	V
Current at 6.3 V.	1.600	A
Maximum heater-cathode voltage:		
Heater negative with respect to cathode:		
Peak	200	V
Heater positive with respect to cathode:		
Peak	200	V
DC component	100	V

Direct Interelectrode Capacitances (Approx.)

Without external shield

Grid No.1 to plate	1.2	pF
Input: G1 to (K, G3, G2, H)	22	pF
Output: P to (K, G3, G2, H)	9.0	pF

MECHANICAL

Operating Position	Any
Type of Cathode	Coated Unipotential
Maximum Overall Length	3.550 in
Seated Length	2.910 to 3.170 in
Diameter	1.438 to 1.562 in
Dimensional Outline	See <i>General Section</i>
Bulb	T12
Cap	Skirted Miniature (JEDEC No.C1-2 or C1-3)
Base	Large-Button Novar 9-Pin with Exhaust Tip (JEDEC E9-88)
Basing Designation for BOTTOM VIEW	9QL

- Pin 1 - Grid No.2
- Pin 2 - Grid No.1
- Pin 3 - Cathode
- Pin 4 - Heater
- Pin 5 - Heater
- Pin 6 - Grid No.1
- Pin 7 - Grid No.2
- Pin 8 - Grid No.3
- Pin 9 - Do Not Use
- Cap - Plate

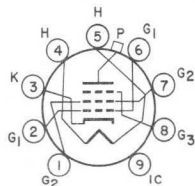

CHARACTERISTICS

For the following characteristics, see Conditions

Amplification Factor	-	-	4	-
Triode Connection ^c				
Plate Resistance	-	-	-	6000 Ω
Transconductance	-	-	-	9500 μmho
DC Plate Current	-	560 ^d	-	80 mA



6KM6

DC Grid-No.2 Current.	-	31 ^d	-	2.4	mA
Cutoff DC Grid-No.1 Voltage .	-110	-	-	-42	V
Plate mA = 1					

Conditions

Heater Voltage.	6.3	6.3	6.3	6.3	V
Peak Positive-Pulse Plate Voltage ^e	6500	-	-	-	V
DC Plate Voltage.	-	60	140	140	V
DC Grid-No.3 Voltage.	30	30	0	30	V
DC Grid-No.2 Voltage.	140	140	140	140	V
DC Grid-No.1 Voltage.	-	0	-24.5	-24.5	V

MAXIMUM RATINGS, DESIGN-MAXIMUM VALUES

For operation in a 525-line, 30-frame system

DC Plate Supply Voltage	770	V
Peak Positive-Pulse Plate Voltage ^e	6500	V
Peak Negative-Pulse Plate Voltage	1500	V
DC Grid-No.3 Voltage ^f	75	V
DC Grid-No.2 (Screen-Grid) Voltage.	220	V
Peak Negative-Pulse Grid-No.1 (Control-Grid) Voltage.	330	V
Cathode Current		
Peak.	950	mA
Average	275	mA
Grid-No.2 Input	3.5	W
Plate Dissipation ^g	20	W
Envelope Temperature.	240	°C
At hottest point on bulb surface		

MAXIMUM CIRCUIT VALUES

Grid-No.1-Circuit Resistance

For grid-No.1-resistor-bias operation	0.47	MΩ
For plate-pulsed operation.	10	MΩ

- ^a Designed to minimize secondary-electron emission from plate and eliminate "knee" discontinuities in zero-bias region.
- ^b Designed to reduce glass problems after long periods of high-voltage and elevated temperature operation.
- ^c With grid No.3 and grid No.2 connected, respectively, to cathode and plate at socket.
- ^d This value can be measured by a method involving a recurrent waveform such that the Maximum Ratings of the tube will not be exceeded.
- ^e This rating is applicable where the duration of the voltage pulse does not exceed 15 per cent of one horizontal scanning cycle. In a 525-line, 30-frame system, 15 per cent of one horizontal scanning cycle is 10 microseconds.
- ^f In horizontal-deflection-amplifier service, a positive voltage may be applied to grid No.3 to reduce interference from "snivets" which may occur in both vhf and uhf television receivers. A typical operating value for this voltage is 30 volts.
- ^g An adequate bias resistor or other means is required to protect the tube in the absence of excitation.



Typical Characteristics

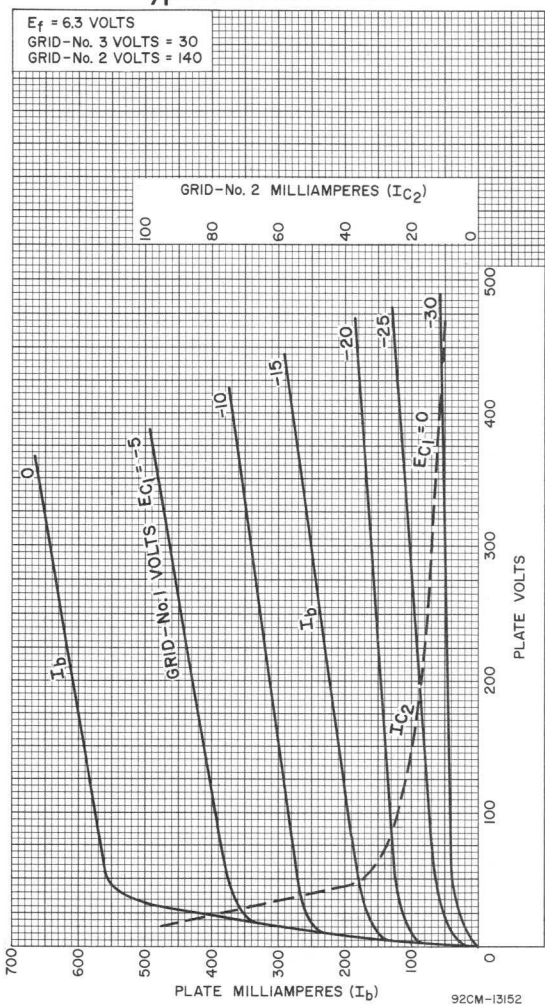

Typical Plate Characteristics

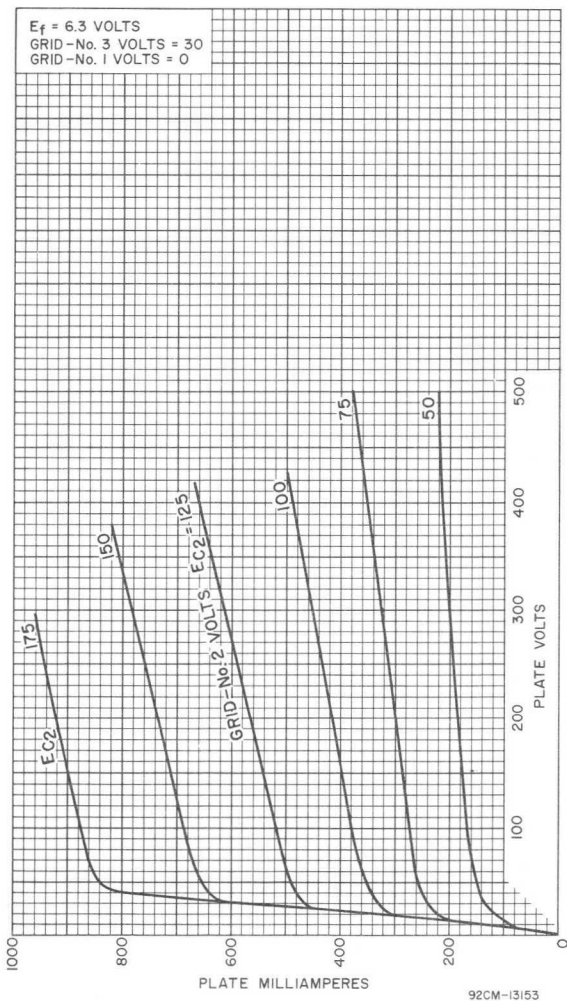

High-Mu Triode— Sharp-Cutoff Pentode

9-PIN MINIATURE TYPE

For Color-Killer, Sound IF Amplifier, and Band-pass-Amplifier Applications in TV Receivers

Electrical:

Heater Characteristics and Ratings:

Voltage (AC or DC)	6.3 ± 0.6	volts
Current at heater volts = 6.3	0.600	amp
Peak heater-cathode voltage:		

Unit: Triode Pentode^a

Heater negative with respect to cathode	200 max.	20 max.	volts
Heater positive with respect to cathode	200 ^b max.	20 max.	volts

Direct Interelectrode Capacitances:

	Without External Shield	With External Shield ^c	
<i>Triode Unit:</i>			
G _T to P _T	3.0	3.0	pf
Input: G _T to (H+G _{3P} +I _S , K _T) . . .	3.2	3.2	pf
Output: P _T to (H+G _{3P} +I _S , K _T) . . .	1.6	2.4	pf
<i>Pentode Unit:</i>			
G _{1P} to P _P	0.046 max.	0.030 max.	pf
Input: G _{1P} to (H+G _{3P} +I _S , G _{2P} , K _P) .	7.5	7.5	pf
Output: P _P to (H+G _{3P} +I _S , G _{2P} , K _P) .	2.2	2.8	pf
G _T to P _P	0.018 max.	0.003 max.	pf
G _{1P} to P _T	0.006 max.	0.002 max.	pf

Characteristics, Class A₁ Amplifier:

	Unit: Triode	Pentode	
Plate Voltage	250	125	volts
Grid-No.2 Voltage	—	125	volts
Grid-No.1 Voltage	—2	—1	volts
Amplification Factor	100	—	
Plate Resistance (Approx.)	31500	150000	ohms
Transconductance	3200	10000	μmhos
Plate Current	1.8	12	ma
Grid-No.2 Current	—	4.5	ma
Grid-No.1 Voltage (Approx.) for plate μ _a = 20	—3.5	—7	volts

Mechanical:

Operating Position	Any
Type of Cathodes	Coated Unipotential
Maximum Overall Length	2-3/16"
Maximum Seated Length	1-15/16"



6KT8

Length, Base Seat to Bulb Top
 (Excluding Tip) 1-9/16" \pm 3/32"
 Diameter 0.750" to 0.875"
 Dimensional Outline See *General Section*
 Bulb T6-1/2
 Base Small-Button Noval 9-Pin (JEDEC No. E9-1)

Basing Designation for BOTTOM VIEW 9QP
 Pin 1 - Triode Cathode
 Pin 2 - Triode Grid
 Pin 3 - Triode Plate
 Pin 4 - Heater
 Pin 5 - See Footnote **a**
 (Heater, Pentode
 Grid No.3,
 Internal Shield)
 Pin 6 - Pentode Cathode
 Pin 7 - Pentode Grid No.1
 Pin 8 - Pentode Grid No.2
 Pin 9 - Pentode Plate

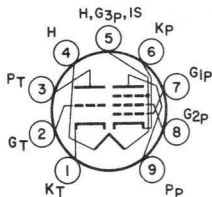

AMPLIFIER — Class A₁

Maximum Ratings, Design-Maximum Values:

	Unit:	Triode	Pentode	
Plate Voltage		330 max.	330 max.	volts
Grid-No.2 Supply Voltage		-	330 max.	volts
Grid-No.2 Voltage		See <i>Grid-No.2 Input Rating Chart</i> at front of Receiving Tube Section		
Grid-No.1 Voltage:				
Positive-bias value		0 max.	0 max.	volts
Grid-No.2 Input:				
For grid-No.2 voltages up to 165 volts		-	0.55 max.	watt
For grid-No.2 voltages between 165 and 330 volts		See <i>Grid-No.2 Input Rating Chart</i> at front of Receiving Tube Section		
Plate Dissipation		1 max.	2.5 max.	watts

Maximum Circuit Values:

Grid-No.1-Circuit Resistance:

For fixed-bias operation	0.5 max.	0.25 max.	megohm
For cathode-bias operation	1 max.	1 max.	megohm

- a** Pin No.5 (Pentode Grid No.3, Internal Shield, and Heater) should be operated at or near ground potential. If the peak cathode-to-grid-No.3 voltage exceeds +20 volts, undesirable changes in the tube characteristics may result.
- b** The dc component must not exceed 100 volts.
- c** With external shield JEDEC No.315 connected to pins 4 and 5.



Diode— Sharp-Cutoff Three-Plate Tetrode

9-PIN MINIATURE TYPE

For Frequency-Divider and Complex-Wave-Generator Circuits of Electronic Musical Instruments

GENERAL DATA

Electrical:

Heater Characteristics and Ratings (*Design-Maximum Values*):

Voltage (AC or DC)	6.3 ± 0.6	volts
Current at heater volts = 6.3	0.300	amp

Peak heater-cathode voltage:

Heater negative with respect to cathode	200	max.	volts
Heater positive with respect to cathode	200 ^a	max.	volts

Direct Interelectrode Capacitances:^b

Tetrode Unit:

Grid No.1 to plate 1A	0.02	max.	pf
Grid No.1 to plate 1B	0.02	max.	pf
Grid No.1 to plate 2	0.06	max.	pf
Grid No.1 to cathode & internal shield, grid No.2, and heater . . .	5.5		pf
Plate 1A to cathode & internal shield, grid No.2, and heater . . .	1.2		pf
Plate 1B to cathode & internal shield, grid No.2, and heater . . .	1.3		pf
Plate 2 to cathode & internal shield, grid No.2, and heater . . .	1.8		pf
Tetrode grid No.1 to diode plate . . .	0.024	max.	pf
Tetrode plate 1A to diode plate . . .	0.18		pf
Tetrode plate 1B to diode plate . . .	0.024		pf
Tetrode plate 2 to diode plate . . .	0.013		pf

Characteristics, Class A₁ Amplifier (Tetrode Unit):

Plates 1A, 1B, and 2 connected together at socket

Plate Voltage	100	volts
Grid-No.2 Voltage	100	volts
Grid-No.1 Supply Voltage	0	volts
Grid-No.1 Resistor (Bypassed)	2.2	megohms
Plate Resistance (Approx.)	30000	ohms
Transconductance	3400	μmhos
Plate Current	4.2	ma
Grid-No.2 Current	1.7	ma
Grid-No.1 Voltage (Approx.) for plate μ a = 20	-4	volts

Triode Connection—

Grid No.2 connected to plates 1A, 1B, and 2 at socket

Plate Voltage	100	volts
Grid-No.1 Supply Voltage	0	volts



6KM8

Grid-No.1 Resistor (Bypassed)	2.2	megohms
Transconductance.	4500	μ hos
Amplification Factor.	45	
Plate Current	5.5	ma

Separate plate operation, plates not under test grounded

Plate Voltage:		
Plate 1A.	100	volts
Plate 1B.	100	volts
Plate 2	100	volts
Grid-No.2 Voltage	100	volts
Grid-No.1 Supply Voltage.	0	volts
Grid-No.1 Resistor (Bypassed)	2.2	megohms
Transconductance:		
Grid No.1 to plate 1A	2000	μ hos
Grid No.1 to plate 1B	2000	μ hos
Grid No.1 to plate 2.	1800	μ hos
Plate Resistance (Approx.):		
Plate 1A.	0.1	megohm
Plate 1B.	0.1	megohm
Plate 2	0.12	megohm
Plate Current:		
Plate 1A.	2.3	ma
Plate 1B.	2.3	ma
Plate 2	2.1	ma
Grid-No.2 Current:		
For plate 1A volts = 100.	3.8	ma
For plate 1B volts = 100.	3.8	ma
For plate 2 volts = 100	3.3	ma

Mechanical:

Operating Position.	Any
Type of Cathode	Coated Unipotential
Maximum Overall Length.	2-5/8"
Maximum Seated Length	2-3/8"
Length, Base Seat to Bulb Top (Excluding tip)	2" \pm 3/32"
Diameter.	0.750" to 0.875"
Dimensional Outline	See <i>General Section</i>
Bulb.	T6-1/2
Base.	Small-Button Noval 9-Pin (JEDEC No.E9-1)
Basing Designation for BOTTOM VIEW.	9QG

- Pin 1 - Tetrode
Plate 1B
- Pin 2 - Tetrode
Plate 1A
- Pin 3 - Diode
Plate
- Pin 4 - Heater
- Pin 5 - Heater

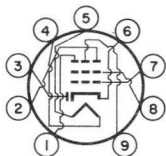

- Pin 6 - Cathode,
Internal
Shield
- Pin 7 - Tetrode
Grid No.1
- Pin 8 - Tetrode
Grid No.2
- Pin 9 - Tetrode
Plate 2



FREQUENCY-DIVIDER & COMPLEX-WAVE-GENERATOR SERVICE

TETRODE UNIT

Maximum Ratings, Design-Maximum Values:

PLATE VOLTAGE:

PLATE 1A.	330 max.	volts
PLATE 1B.	330 max.	volts
PLATE 2	330 max.	volts

GRID-No.2 (SCREEN-GRID)

SUPPLY VOLTAGE.	330 max.	volts
GRID-No.2 VOLTAGESee <i>Grid-No.2 Input Rating Chart</i> at front of Receiving Tube Section	

GRID-No.1 (CONTROL-GRID) VOLTAGE:

Negative-bias value	50 max.	volts
Positive-bias value	0 max.	volts

GRID-No.2 INPUT:

For grid-No.2 voltages up to 165 volts	0.65 max.	watt
For grid-No.2 voltages between 165 and 330 voltsSee <i>Grid-No.2 Input Rating Chart</i> at front of Receiving Tube Section	

PLATE 1A DISSIPATION.	1 max.	watt
PLATE 1B DISSIPATION.	1 max.	watt
PLATE 2 DISSIPATION	1 max.	watt

Maximum Circuit Values:

Grid-No.1-Circuit Resistance:

For grid-No.1-resistor- bias operation.	2.2 max.	megohms
--	----------	---------

DIODE UNIT

Maximum Ratings, Design-Maximum Values:

PLATE CURRENT	1 max.	ma
-------------------------	--------	----

Characteristics, Instantaneous Test Condition:

Plate Current for plate volts = 10.	2	ma
---	---	----

^a The dc component must not exceed 100 volts.^b Without external shield.

6KM8

AVERAGE CHARACTERISTICS Tetrode Unit

$E_f = 6.3$ VOLTS
GRID-No. 2 VOLTS = 100
PLATES 1A, 1B, AND 2 CONNECTED
TOGETHER AT SOCKET.

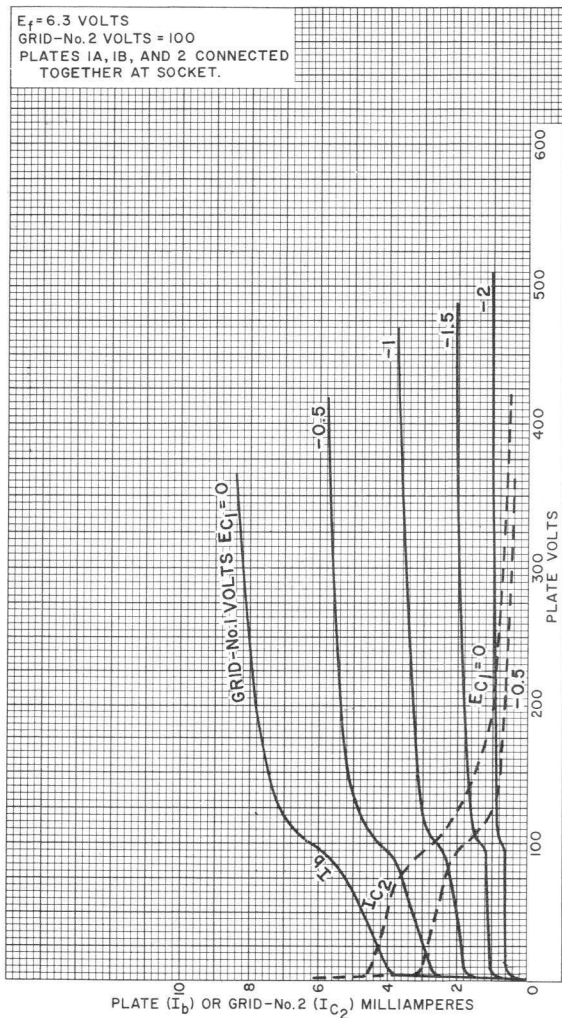

92CM-11713R1



AVERAGE PLATE CHARACTERISTICS Tetrode Unit—Triode Connection

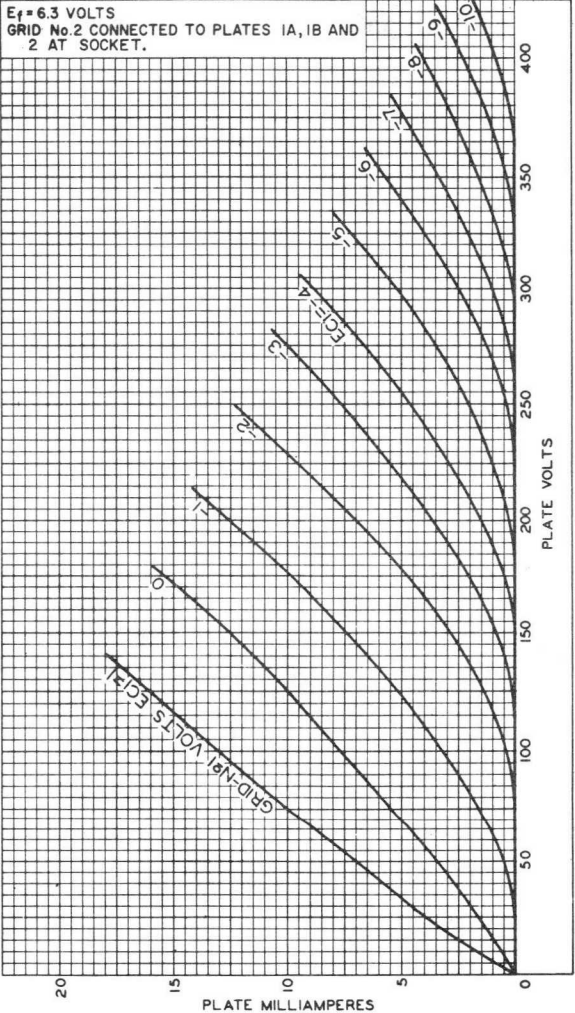

92CM-11748





Semiremote-Cutoff Pentode

9-PIN MINIATURE TYPE

FRAME-GRID CONSTRUCTION

DARK HEATER

For High-Gain IF-Amplifier Applications in TV Receivers

ELECTRICAL CHARACTERISTICS

Bogey Values^a

Heater Voltage (AC or DC)	E_h	6.3	V
Heater Current	I_h	300	mA
Heater Warm-up Time.	-	11	s

Direct Interelectrode Capacitances

Without external shield

Grid No.1 to plate.	C_{g1-p}	0.019 max	pF
Input: G1 to (K, G3 + IS, G2, H). . .	C_i	9.5	pF
Output: P to (K, G3 + IS, G2, H). . .	C_o	3	pF

For the following characteristics, see Conditions

Plate Resistance (Approx.)	r_p	160	-	Ω
Transconductance	g_m	18000	-	μmho
DC Plate Current	I_b	17	-	mA
DC Grid-No.2 Current	I_{c2}	4.2	-	mA
Cutoff DC Grid-No.1 Voltage	$E_{c1}(co)$	-	-22	V

For $g_m = 10 \mu\text{mho}$

Conditions

Heater Voltage	E_h	Bogey Value		V
DC Plate Supply Voltage.	E_{bb}	125	170	V
DC Grid-No.3 Voltage	E_{c3}	0	0	V
DC Grid-No.2 Supply Voltage	E_{cc2}	125	170	V
Grid No.1.	-	Connected to negative end of R_k		
Cathode Resistor	R_k	56	56	Ω

MECHANICAL CHARACTERISTICS

Operating Position	Any
Type of Cathode.	Coated Unipotential
Maximum Overall Length	2.187 in
Maximum Seated Length.	1.937 in
Maximum Diameter	0.875 in
Length, Base Seat to Bulb Top.	1.469 to 1.656 in
Excluding tip	
Dimensional Outline (JEDEC 6-2).	See <i>General Section</i>
Envelope	JEDEC T6-1/2
Base	Small-Button Noval 9-Pin (JEDEC E9-1)



TERMINAL DIAGRAM (Bottom View)

- Pin 1 - Cathode
- Pin 2 - Grid No.1
- Pin 3 - Cathode
- Pin 4 - Heater
- Pin 5 - Heater
- Pin 6 - No Internal Connection
- Pin 7 - Plate
- Pin 8 - Grid No.2
- Pin 9 - Grid No.3, Internal Shield

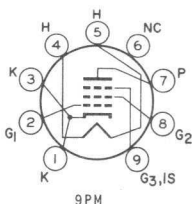

DESIGN-MAXIMUM RATINGS

For operation as a Class A₁ Amplifier Tube in TV Receivers

DC Plate Voltage	E_b	330	V
DC Grid-No.3 (Suppressor-Grid) Voltage	E_{c3}	+0	V
DC Grid-No.2 (Screen-Grid) Supply Voltage.	E_{cc2}	330	V
DC Grid-No.2 Voltage	E_{c2}	See <i>Grid-No.2</i>	
		<i>Input Rating Chart</i>	
		at front of Receiving Tube Section	
DC Grid-No.1 (Control-Grid) Voltage.	E_{c1}	+0	V
Heater-Cathode Voltage			
Peak	e_{hkm}	±200	V
Average.	$E_{hk(av)}$	100	V
Heater Voltage (AC or DC).	E_h	5.7 to 6.9	V
Grid-No.2 Input	P_{g2}		
For $E_{c2} \leq 165$ V.		0.6	W
For $E_{c2} > 165$ V and ≤ 330 V.	-	See <i>Grid-No.2</i>	
		<i>Input Rating Chart</i>	
		at front of Receiving Tube Section	
Plate Dissipation.	P_b	3.1	W

MAXIMUM CIRCUIT VALUES

Grid-No.1 Circuit Resistance	$R_{g1(ckt)}$		
For fixed-bias operation	-	250	k Ω
For cathode-bias operation	-	1	M Ω

^a Unless otherwise specified.



Typical Characteristics

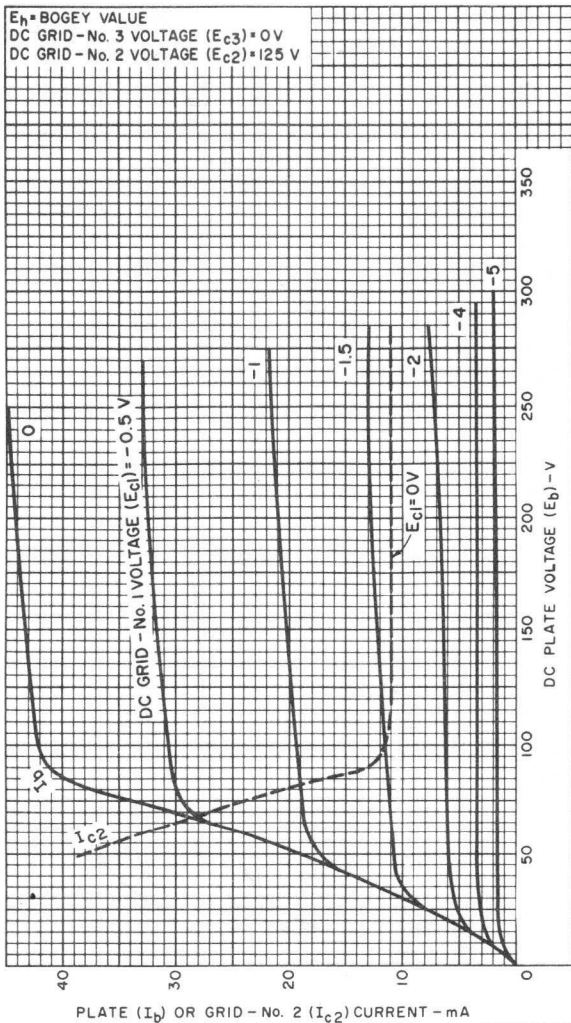

92CM-14009



6KT6

Typical Characteristics

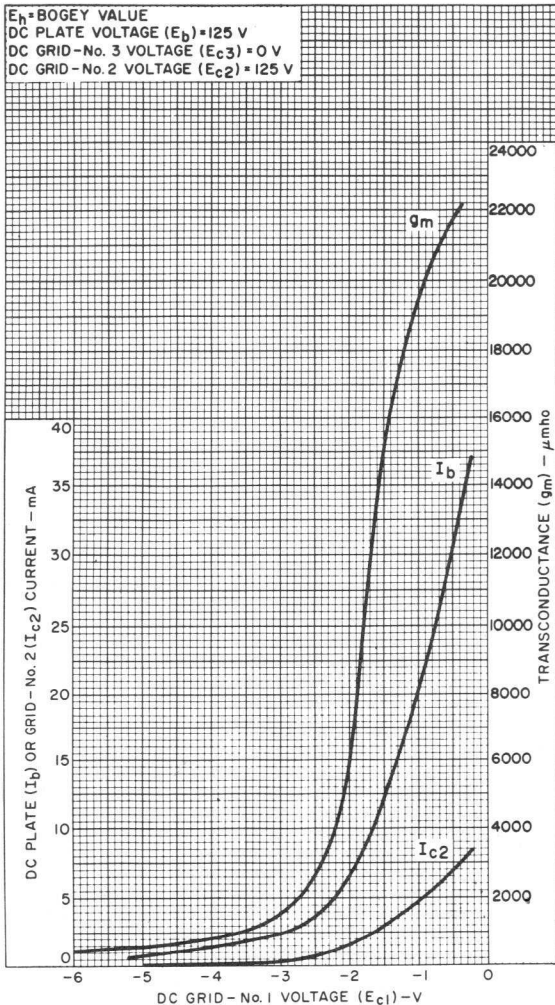

92CM-14005



Beam Power Tube

NOVAR TYPE

DARK HEATER

*For High-Voltage-Pulse Shunt-Regulator
Applications in Color-TV Receivers*

ELECTRICAL CHARACTERISTICS

Bogey Values

Heater Voltage	E_h	6.3	V
Heater Current	I_h	1.600	A
Direct Interelectrode Capacitances			
Without external shield			
Grid No.1 to plate	C_{g1-p}	1.2	pF
Input: G1 to (K,G3,G2,H)	C_i	22	pF
Output: P to (K,G3,G2,H)	C_o	9.0	pF

For the following characteristics, see Conditions

Amplification Factor

(Triode Connection)^a

Plate Resistance (Approx.)	r_p	-	4	-	
Transconductance	g_m	-	-	6000	Ω
DC Plate Current	I_b	580 ^b	-	80	mA
DC Grid-No.2 Current	I_{c2}	24 ^b	-	2.4	mA
Cutoff DC Grid-No.1 Voltage	$E_{c1}(co)$	-	-	-42	V

Plate mA = 1

Conditions

Heater Voltage	E_h	Bogey Value	V
DC Plate Voltage	E_b	100 140	V
DC Grid-No.3 Voltage	E_{c3}	0 0	V
DC Grid-No.2 Voltage	E_{c2}	140 140	V
DC Grid-No.1 Voltage	E_{c1}	0 -24.5	V

MECHANICAL CHARACTERISTICS

Operating Position	Any
Type of Cathode	Coated Unipotential
Dimensional Outline (JEDEC 12-96)	See <i>General Section</i>
Maximum Overall Length	3.130 in
Maximum Seated Length	2.750 in
Maximum Diameter	1.562 in
Envelope	JEDEC Designation T12
Base ^c	Large-Button Novar 9-Pin with Exhaust Tip (JEDEC Designation E9-88)

TERMINAL DIAGRAM (Bottom View)

- Pin 1 -Grid No.2
- Pin 2 -Grid No.1
- Pin 3 -Cathode
- Pin 4 -Heater
- Pin 5 -Heater
- Pin 6 -Grid No.3
- Pin 7 -Grid No.2
- Pin 8 -Do Not Use
- Pin 9 -Plate

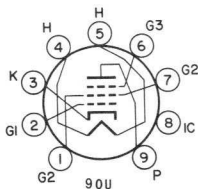

6KV6

DESIGN-MAXIMUM RATINGS

For operation as a High-Voltage-Pulse Shunt-Regulator Tube in Color-Television Receivers in a 525-line, 30-frame system

DC Plate Supply Voltage ($I_b = 0$ mA)	E_{bb}	770	V
Peak Positive-Pulse Plate Voltage ^c	e_{bm}	6500	V
Peak Negative-Pulse Plate Voltage	$-e_{bm}$	1500	V
DC Grid-No.3 Voltage	E_{c3}	75	V
DC Grid-No.2 (Screen-Grid) Voltage	E_{c2}	220	V
Grid No.1 (Control-Grid) Voltage			
Peak negative-pulse value	$-e_{c1m}$	330	V
Negative dc value (bias)	$-E_{c1}$	75	V
Heater-Cathode Voltage			
Peak	e_{hkm}	$\begin{cases} +200 \\ -500 \end{cases}$	V
Average ^d	$E_{hk(av)}$		100
Heater Voltage (AC or DC)	E_h	5.7 to 6.9	V
Cathode Current			
Peak	i_{km}	950	mA
Average ^d	$I_{k(av)}$	275	mA
Grid-No.2 Input	P_{g2}	3.5	W
Plate Dissipation ^e	P_b	20 ^f	W
Envelope Temperature (at hottest point on envelope surface)	T_E	240	°C

MAXIMUM CIRCUIT VALUE

Grid-No.1-Circuit Resistance	$R_{g1(ckt)}$		
For grid-No.1-resistor-bias operation	-	1	MΩ

- ^a With grid No.3 and grid No.2 connected, respectively, to cathode and plate at socket.
- ^b This value can be measured by a method involving a recurrent waveform such that the Maximum Ratings of the tube will not be exceeded.
- ^c This rating is applicable where the duration of the voltage pulse does not exceed 15% of one horizontal scanning cycle. In a 525-line, 30-frame system, 15% of one horizontal scanning cycle is 10 μs.
- ^d Measured with a dc meter.
- ^e Adequate circuit precautions must be taken to protect the tube in the absence of grid-No.1 bias.
- ^f Plate dissipations up to 24 W maximum are permissible for short periods of time (up to 10 s maximum) provided the maximum envelope-temperature rating is not exceeded.



Beam Power Tube

NOVAR TYPE

For High-Voltage-Pulse Shunt-Regulator
Applications in Color-TV Receivers

ELECTRICAL CHARACTERISTICS - Bogey Values

Heater Voltage, ac or dc. . . E_h	6.3	V
Heater Current I_h	1.6	A
Direct Interelectrode Capacitances: ^a		
Grid No.1 to plate c_{g1-p}	0.6	pF
Input: G1 to (K,G3,G2,H) . . c_i	22	pF
Output: P to (K,G3,G2,H) . . c_o	9.0	pF

For the following characteristics, see Conditions below.

Amplification Factor (Triode Connection) ^b μ	-	4	-	
Plate Resistance (Approx.). r_p	-	-	10000	Ω
Transconductance g_m	-	-	6000	μmho
DC Plate Current I_b	440 ^c	-	40	mA
DC Grid-No.2 Current I_{c2}	30 ^c	-	2.4	mA
Cutoff DC Grid-No.1 Voltage for $I_b = 1 \text{ mA}$. . . $E_{c1(co)}$	-	-	-42	V

Conditions:

Heater Voltage E_h	Bogey Value			V
DC Plate Voltage E_b	100	140	140	V
DC Grid-No.3 Voltage . . . E_{c3}	0	0	0	V
DC Grid-No.2 Voltage . . . E_{c2}	140	140	140	V
DC Grid-No.1 Voltage . . . E_{c1}	0	-24.5	-24.5	V

MECHANICAL CHARACTERISTICS

Dimensional Outline	JEDEC No.12-97
Maximum Overall Length	3.380in. (85.85 mm)
Maximum Seated Length	3.000in. (76.2 mm)
Maximum Diameter	1.562in. (39.6 mm)
Envelope	JEDEC Designation T12
Base ^d	Large-Button Novar 9-Pin with Exhaust Tip (JEDEC Designation E9-88)

6KV6A

Terminal-Connections Designation JEDEC 9QU
 Type of Cathode Coated Unipotential
 Operating Position Any

MAXIMUM RATINGS – Design-Maximum Values^e

For operation as a High-Voltage-Pulse Shunt-Regulator Tube in Color Television Receivers in a 525-line, 30-frame system.

DC Plate Supply Voltage			
($I_b = 0$ mA)	E_{bb}	900	V
Peak Positive-Pulse Plate Voltage . . .	e_{bm}	6500	V
Peak Negative-Pulse Plate Voltage . . .	$-e_{bm}$	1500	V
DC Grid-No.3 Voltage	E_{c3}	75	V
DC Grid-No.2 (Screen-Grid) Voltage . . .	E_{c2}	220	V
Peak Positive-Pulse Grid-No.2 Voltage .	e_{c2m}	600	V
Grid No.1 (Control-Grid) Voltage:			
Peak negative-pulse value	$-e_{c1m}$	330	V
Negative dc value (bias)	$-E_{c1}$	250	V
Heater-Cathode Voltage:			
Peak	e_{hkm}	} +200 } -500	V
Average ^g	$E_{hk(av)}$		
Heater Voltage	E_h	5.7 to 6.9	V
Cathode Current:			
Peak	i_{km}	950	mA
Average ^g	$I_{k(av)}$	275	mA
Grid-No.2 Input	P_{g2}	2.0	W
Plate Dissipation ^h	P_b	28 ^k	W
Envelope Temperature (at hottest point on envelope surface)	T_E	240	°C

MAXIMUM CIRCUIT VALUE

Grid-No.1-Circuit Resistance:	$R_{g1(ckt)}$	
For grid-No.1-resistor-bias operation		1 MΩ

- ^a Measured without external shield in accordance with the current issue of EIA Standard RS-191.
- ^b With grid No.3 and grid No.2 connected, respectively, to cathode and plate at socket.
- ^c This value can be measured by a method involving a recurrent waveform such that the Maximum Ratings of the tube will not be exceeded.
- ^d Designed to mate with "Novar 9-Contact" Socket generally available from your local RCA Distributor.
- ^e As defined in the current issue of EIA Standard RS-239.
- ^f This rating is applicable where the duration of the voltage pulse does not exceed 15% of one horizontal scanning cycle. In a 525-line, 30-frame system, 15% of one horizontal scanning cycle is $10\mu\text{s}$.
- ^g Measured with a dc meter.
- ^h Adequate circuit precautions must be taken to protect the tube in the absence of grid-No.1 bias.
- ^k Plate dissipations up to 32W maximum are permissible for short periods of time provided the maximum envelope-temperature rating is not exceeded. This condition may exist under high-line voltage, zero picture tube beam current.

TERMINAL DIAGRAM — Bottom View

- Pin 1 - Grid No.2
 Pin 2 - Grid No.1
 Pin 3 - Cathode
 Pin 4 - Heater
 Pin 5 - Heater
 Pin 6 - Grid No.3
 Pin 7 - Grid No.2
 Pin 8 - Do Not Use
 Pin 9 - Plate

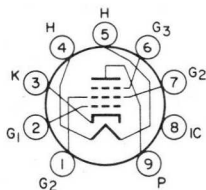

JEDEC 9QU

6KV6A

DIMENSIONAL OUTLINE — JEDEC No. 12-97

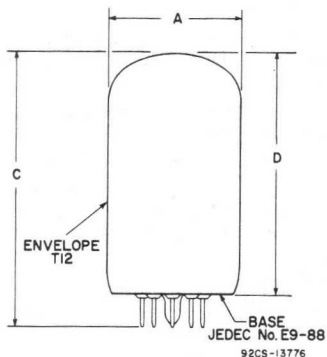

DIMENSION	INCHES		MILLIMETERS	
	Min.	Max.	Min.	Max.
A	1.438*	1.562	36.6*	39.6
C	—	3.380	—	85.85
D	2.750	3.000	69.9	76.2
MILLIMETER DIMENSION DERIVED FROM INCH DIMENSION				
* Applies to the minimum diameter except in the area of the seal.				

High-Mu Triode— Sharp-Cutoff Pentode

9-PIN MINIATURE TYPE

FRAME-GRID CONSTRUCTION

*For Use as a Combined Voltage Amplifier
and Video Output Tube in TV Receivers*

ELECTRICAL

Heater Characteristics and Ratings

Voltage (AC or DC)	6.3 ± 0.6	V
Current at heater volts = 6.3	0.775	A
Peak heater-cathode voltage (Each unit):		
Heater negative with respect to cathode	200	V
Heater positive with respect to cathode	200 ^a	V

Direct Interelectrode Capacitances^b

Triode Unit:

Grid to plate	3.7	pF
Grid to cathode, pentode cathode, pentode grid No.3 & internal shield, and heater.	2.5	pF
Plate to cathode, pentode cathode, pentode grid No.3 & internal shield, and heater.	2.4	pF
Triode grid to pentode plate.	0.015 max	pF

Pentode Unit:

Grid No.1 to plate.	0.12 max	pF ←
Grid No.1 to cathode & grid No.3 & internal shield, grid No.2, and heater.	13.0	pF
Plate to cathode & grid No.3 & internal shield, grid No.2, and heater.	4.8	pF
Pentode plate to triode plate	0.17 max	pF

Characteristics, Class A₁ Amplifier

	Triode Unit	Pentode Unit	
Plate Supply Voltage.	-	125	200 V
Plate Voltage	200	-	- V
Grid-No.2 Supply Voltage.	-	125	125 V
Grid-No.1 Supply Voltage.	-2	-	- V
Cathode Resistor.	-	82	68 Ω
Amplification Factor.	70	-	-
Plate Resistance (Approx.)	17500	55000	75000 Ω
Transconductance.	4000	21000	23000 μmho
Plate Current	4	16.5	20 mA ←
Grid-No.2 Current	-	3.1	3.5 mA ←
Grid-No.1 Voltage (Approx.) for plate current = 100 μA	-4.5	-4.2	-4.2 V

← Indicates a change.



6KV8

MECHANICAL

Operating Position	Any
Maximum Overall Length	2-5/8 in
Maximum Seated Length	2-3/8 in
Length, Base Seat to Bulb Top (Excluding tip)	2 ± 3/32 in
Diameter	0.750 to 0.875 in
Dimensional Outline	See <i>General Section</i>
Bulb	T6-1/2
Base	Small-Button Noval 9-Pin (JEDEC No.E9-1)

BASING DIAGRAM (Bottom View)

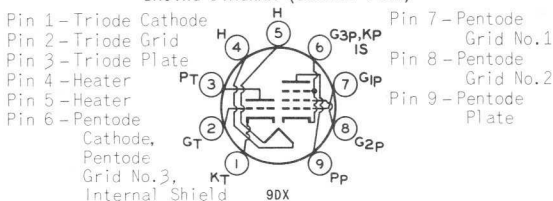

AMPLIFIER — Class A₁ Design-Maximum Ratings

	Triode Unit	Pentode Unit	
Plate Voltage	300	300 max	V
Grid-No.2 (Screen-Grid) Supply Voltage	-	300 max	V
Grid-No.2 Voltage	-	See <i>Grid-No.2</i>	
<i>Input Rating Chart at front of Receiving Tube Section</i>			
Grid-No.1 (Control-Grid) Voltage			
Positive-bias value	0	0 max	V
Grid-No.2 Input			
For grid-No.2 voltages up to 150 V.	-	1 max	W
For grid-No.2 voltages between 150 and 300 V.	-	See <i>Grid-No.2</i>	
<i>Input Rating Chart at front of Receiving Tube Section</i>			
Plate Dissipation	1	5 max	W

Maximum Circuit Values

	Triode Unit	Pentode Unit	
Grid-No.1-Circuit Resistance			
For fixed-bias operation	0.5	0.1 max	MΩ
For cathode-bias operation	1	0.25 max	MΩ

^a The dc component must not exceed 100 volts.

^b Without external shield.



Average Plate Characteristics Triode Unit

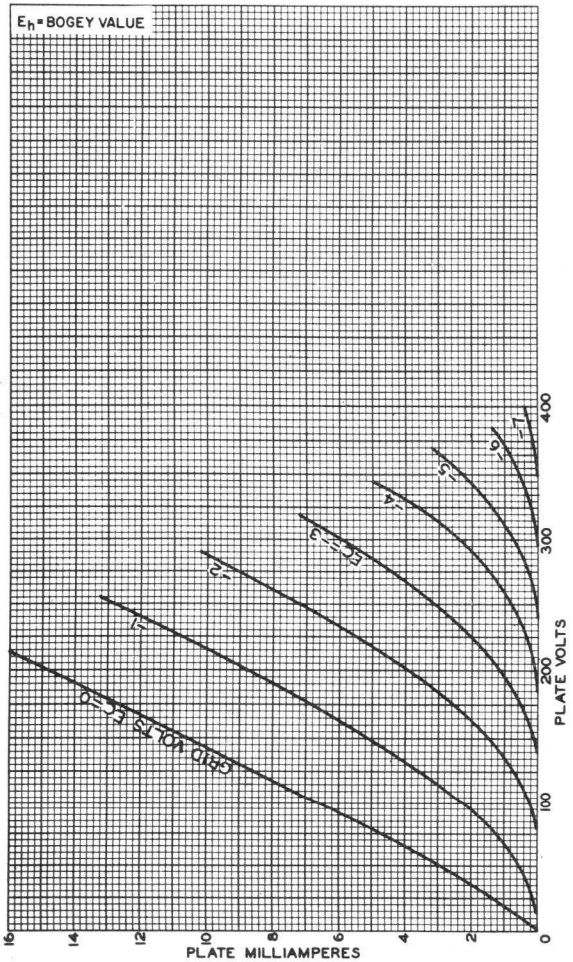

92CM-8644RI



6KV8

Average Characteristics Triode Unit

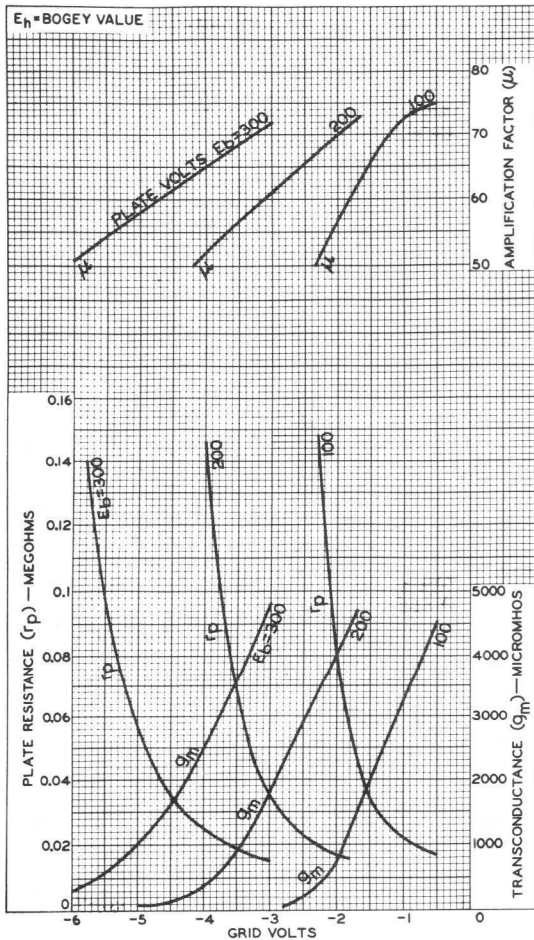

92CM-10874RI

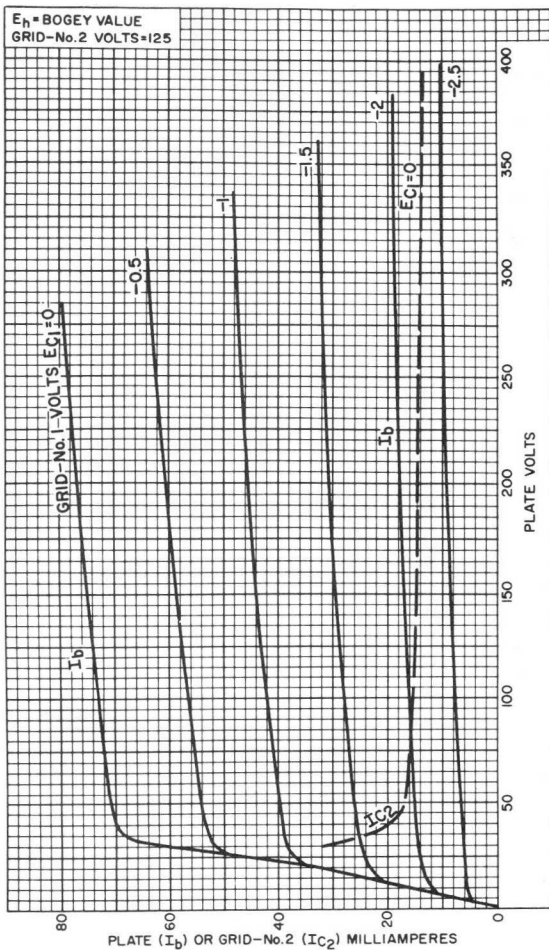

Average Characteristics
Pentode Unit

92CM-11946R2



6KV8

Average Characteristics Pentode Unit

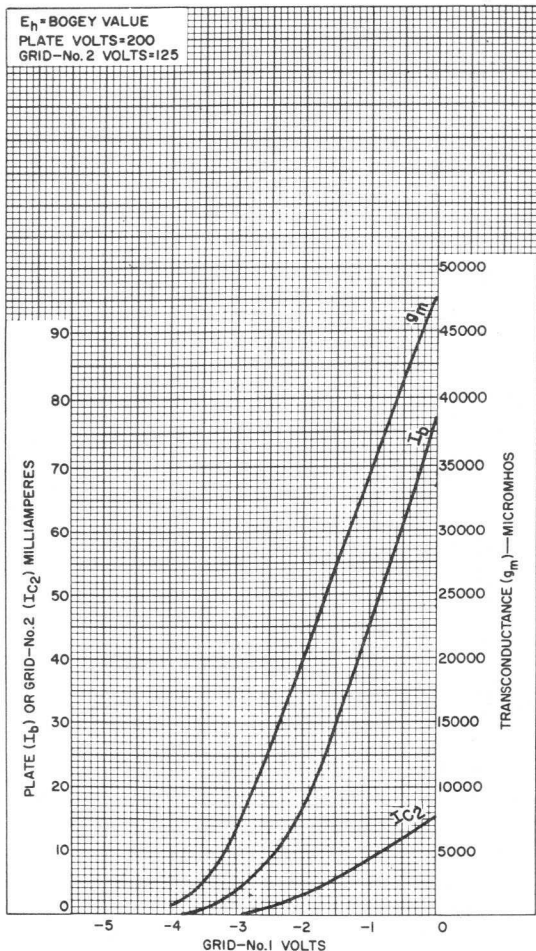

92CM-11947R2



Sharp-Cutoff Pentode

9-PIN MINIATURE TYPE

FRAME-GRID CONSTRUCTION

DARK HEATER

For Video-Output-Amplifier Service in Color-TV Receivers

ELECTRICAL CHARACTERISTICS

Bogey Values^a

Heater Voltage (AC or DC)	E_h	6.3	V
Heater Current	I_h	0.520	A
Direct Interelectrode Capacitances Without external shield			
Grid No.1 to plate	C_{g1-p}	0.16 max	pF
Input: G1 to (K, G3 + IS, G2, H)	C_{ci}	14	pF
Output: P to (K, G3 + IS, G2, H).	C_o	6.0	pF

For the following characteristics, see Conditions

Plate Resistance (Approx.)	r_p	40	k Ω
Transconductance	g_m	30000	μ mho
DC Plate Current	I_b	30	mA
DC Grid-No.2 Current	I_{c2}	5.2	mA
Cutoff DC Grid-No.1 Voltage.	$E_{c1}(co)$	-4.5	V

Plate μ A = 100

Conditions

Heater Voltage	E_h	Bogey Value	V
Plate Supply Voltage	E_{bb}	200	V
Grid-No.3		connected to cathode at socket	
Grid-No.2 Supply Voltage	E_{cc2}	135	V
Grid-No.1 Supply Voltage	E_{cc1}	0	V
Cathode Resistor	R_k	47	Ω

MECHANICAL CHARACTERISTICS

Operating Position	Any
Type of Cathode.	Coated Unipotential
Maximum Overall Length	2.625 in
Maximum Seated Length.	2.375 in
Length, Base Seat to Bulb Top Excluding tip	1.906 to 2.094 in
Maximum Diameter	0.875 in
Dimensional Outline (JEDEC 6-3).	See <i>General Section</i>
Envelope	JEDEC T6-1/2
Base	Small-Button Noval 9-Pin (JEDEC E9-1)

TERMINAL DIAGRAM (Bottom View)

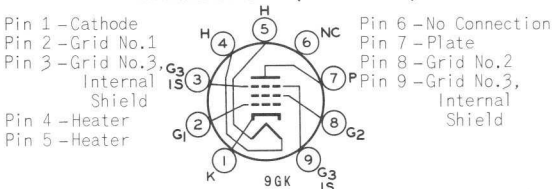

6KY6

DESIGN-MAXIMUM RATINGS

For operation as a Class A₁ Amplifier

Plate Voltage.	E_b	330	V
Grid-No.2 (Screen-Grid) Supply Voltage.	E_{cc2}	330	V
Grid-No.2 Voltage.	E_{c2}		See Grid-No.2 Input Rating Chart at front of Receiving Tube Section
Grid-No.1 (Control-Grid) Voltage			
Positive-bias value.	E_{c1}	0	V
Heater-Cathode Voltage			
Peak	e_{hkm}	±200	V
DC	E_{hk}	100	V
Heater Voltage (AC or DC)	E_h	5.7 to 6.9	V
Grid-No.2 Input	P_{g2}		
For $E_{c2} \leq 165$ V.		1	W
For $E_{c2} > 165$ V and ≤ 330 V.	-		See Grid-No.2-Input Rating Chart at front of Receiving Tube Section
Plate Dissipation.	P_b	9	W

MAXIMUM CIRCUIT VALUES

Grid-No.1-Circuit Resistance	$R_{g1}(\text{ckt})$		
For fixed-bias operation.	-	0.1	MΩ
For cathode-bias operation.	-	0.25	MΩ

^a Unless otherwise specified.



Typical Characteristics

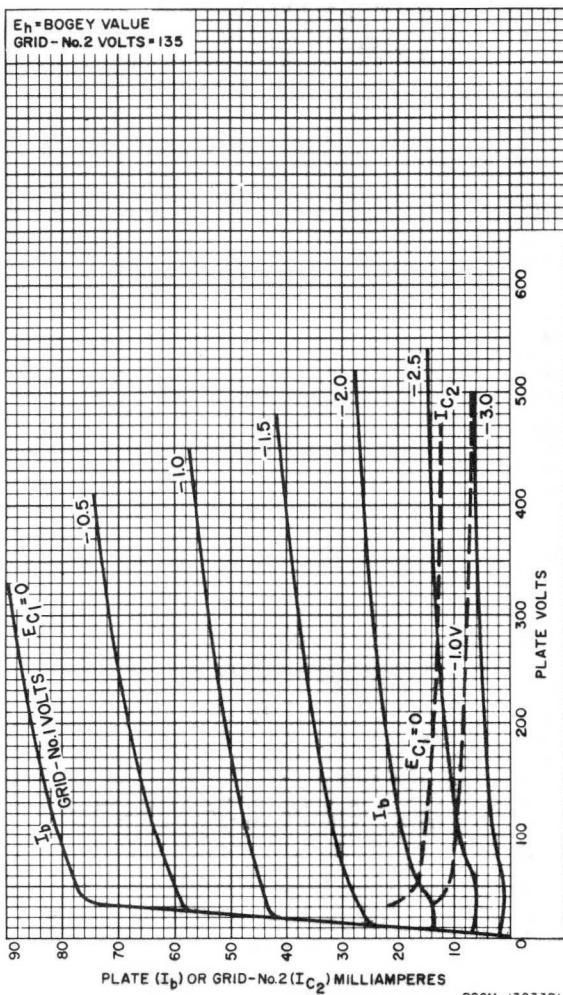

Typical Characteristics

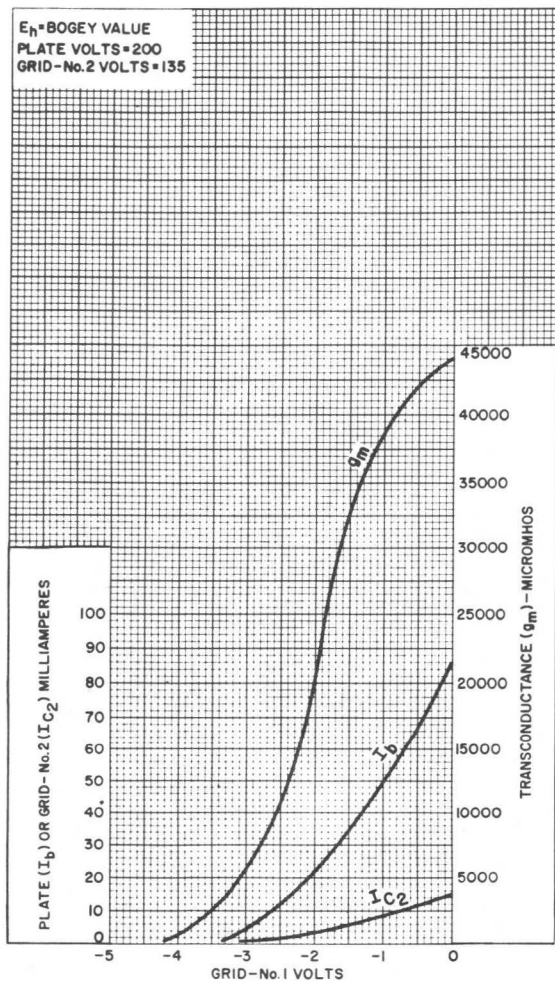

92CM-13832R1

High-Mu Triode—Beam Power Tube

NOVAR TYPE

For Combined Vertical-Deflection Oscillator
and Amplifier Service in TV Receivers

Electrical:

Heater Characteristics and Ratings:

Voltage (AC or DC)	6.3 ± 0.6	volts
Current at heater volts = 6.3	1.100	amp
Peak heater-cathode voltage (Each unit):		
Heater negative with respect to cathode	200 max.	volts
Heater positive with respect to cathode	200 ^a max.	volts

Direct Interelectrode Capacitances (Approx.):^b

Triode Unit:

Grid to plate	0.44	pf
G _T to (K _T , H)	15.0	pf
P _T to (K _T , H)	7.0	pf

Beam Power Unit:

Grid No.1 to plate	0.048	pf
G _{1B} to (K _B +G _{3B} , G _{2B} , H)	2.6	pf
P _B to (K _B +G _{3B} , G _{2B} , H)	0.28	pf

Mechanical:

Operating Position	Any
Type of Cathodes	Coated Unipotential
Maximum Overall Length	2.380"
Seated Length	1.750" to 2.000"
Diameter	1.062" to 1.188"
Dimensional Outline	See <i>General Section</i>
Bulb	T9
Base	Small Button Novar 9-Pin with Exhaust Tip (JEDEC No. E9-89)

Basing Designation for BOTTOM VIEW 9QT

- Pin 1 - Triode Cathode
- Pin 2 - Beam Power Grid No.1
- Pin 3 - Beam Power Cathode & Grid No.3
- Pin 4 - Heater
- Pin 5 - Heater
- Pin 6 - Beam Power Plate
- Pin 7 - Beam Power Grid No.2
- Pin 8 - Triode Plate
- Pin 9 - Triode Grid

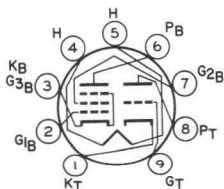

Characteristics, Class A₁ Amplifier:

	Triode Unit		Beam Power Unit		
Plate Voltage	250	50	135	120	volts
Grid-No.2 Voltage	-	120	120	Connected	volts
				to plate	
				at socket	
Grid-No.1 Voltage	-3	0	-10	-10	volts
Amplification Factor	64	-	-	7	



6KY8A

	Triode Unit	Beam Power Unit		
Plate Resistance (Approx.),	40000	-	18000	- ohms
Transconductance.	1600	-	8400	- μ mhos
Plate Current	1.4	170 ^c	39	- ma
Grid-No.2 Current	-	20 ^c	3	- ma
Grid-No.1 Voltage (Approx.) for plate ma = 1	-	-	-24	- volts

VERTICAL-DEFLECTION OSCILLATOR (Triode Unit)

Maximum Ratings, Design-Maximum Values:

For operation in a 525-line, 30-frame system^d

DC Plate Voltage.	330 max.	volts
Peak Negative-Pulse Grid Voltage.	400 max.	volts
Peak Cathode Current.	77 max.	ma
Average Cathode Current	22 max.	ma
Plate Dissipation	1.5 max.	watts

Maximum Circuit Values:

Grid-Circuit Resistance: For grid-resistor-bias operation. . . .	2.2 max.	megohms
---	----------	---------

VERTICAL-DEFLECTION AMPLIFIER (Beam Power Unit)

Maximum Ratings, Design-Maximum Values:

For operation in a 525-line, 30-frame system^d

DC Plate Voltage.	300 max.	volts
Peak Positive-Pulse Plate Voltage ^e	2000 abs.max.	volts
DC Grid-No.2 (Screen-Grid) Voltage. . . .	150 max.	volts
Peak Negative-Pulse Grid-No.1 (Control-Grid) Voltage.	250 max.	volts
Peak Cathode Current.	200 max.	ma
Average Cathode Current	70 max.	ma
Plate Dissipation	12 max.	watts
Grid-No.2 Input	1.9 max.	watts

Maximum Circuit Values:

Grid-No.1-Circuit Resistance: For grid-resistor-bias operation. . . .	2.2 max.	megohms
--	----------	---------

^a The dc component must not exceed 100 volts.

^b Without external shield.

^c This value can be measured by a method involving a recurrent wave form such that the plate dissipation and grid-No.2 input will be kept within ratings in order to prevent damage to the tube.

^d As described in "Standards of Good Engineering Practice Concerning Television Broadcast Stations", Federal Communications Commission.

^e This rating is applicable where the duration of the voltage pulse does not exceed 15 per cent of one vertical scanning cycle. In a 525-line, 30-frame system, 15 per cent of one vertical scanning cycle is 2.5 milliseconds.



AVERAGE CHARACTERISTICS Beam Power Unit

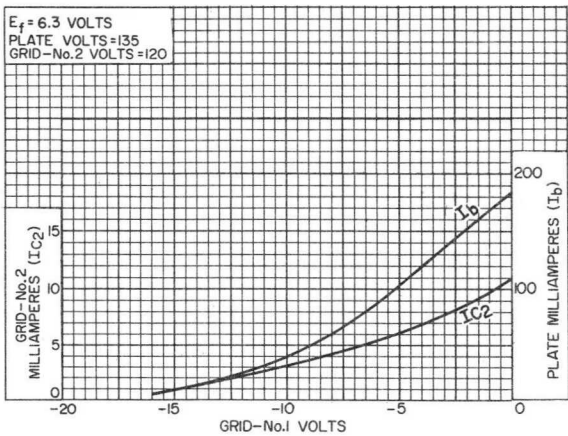

92CS-11929



6KY8A

AVERAGE CHARACTERISTICS Beam Power Unit

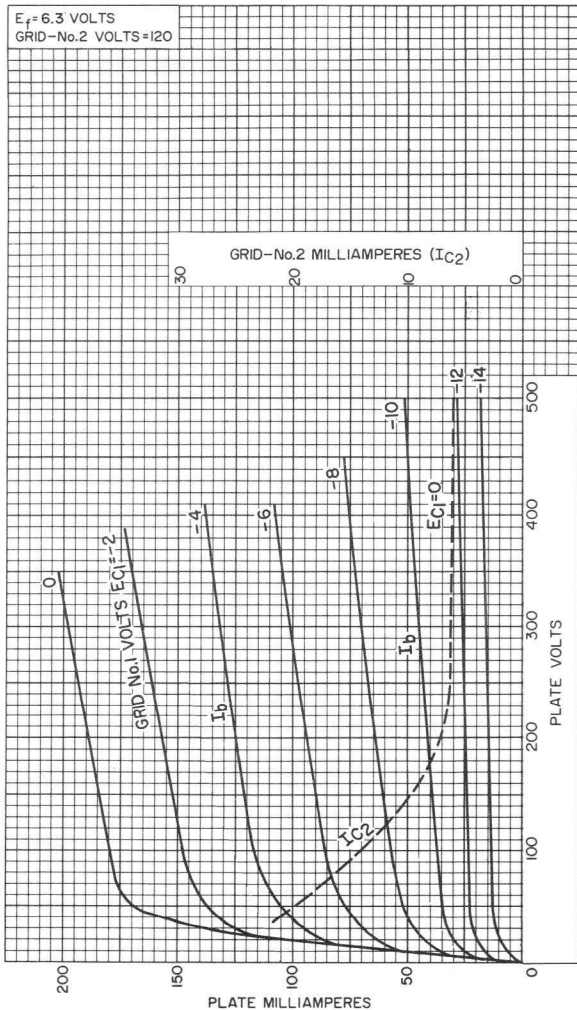

92CM-11942



AVERAGE CHARACTERISTICS Triode Unit

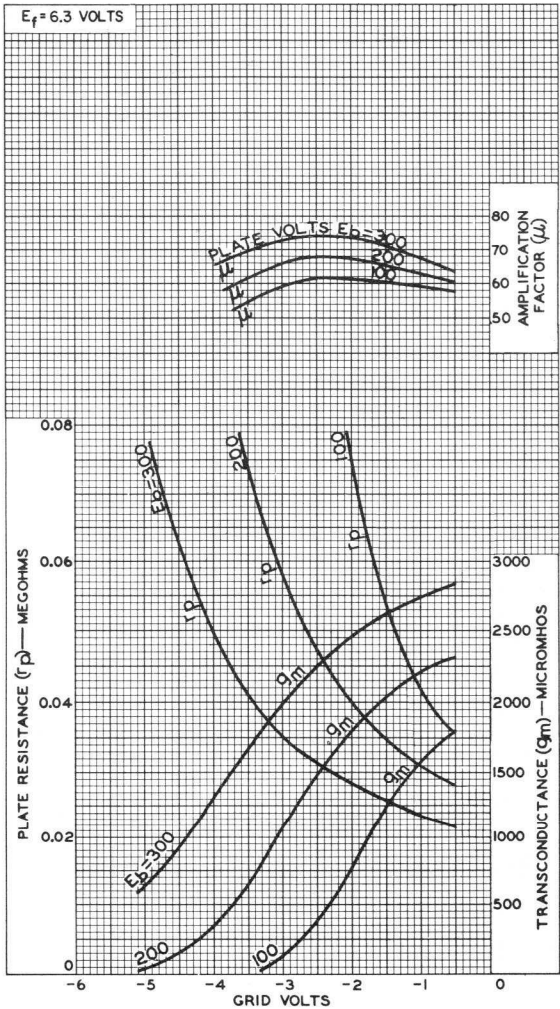

92CM-11945



6KY8A

AVERAGE CHARACTERISTICS Triode Unit

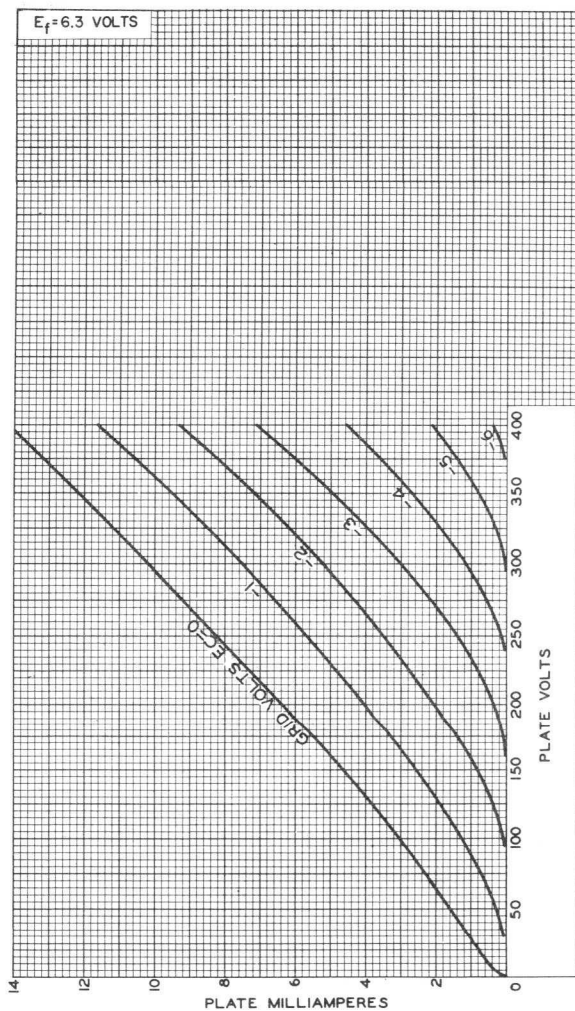

92CM-11944



Medium-Mu Triode— Sharp-Cutoff Pentode

9-PIN MINIATURE TYPE

For Oscillator-Mixer Service in VHF TV-Tuner Applications

Electrical:

Heater Characteristics and Ratings:

Voltage (AC or DC)	6.3 ^a	6.3 ± 0.6 volts
Current	0.450 ± 0.030	0.450 ^b amp
Warm-up time (Average)	11	- sec

Peak heater-cathode voltage (Each Unit):

Heater negative with respect to cathode	200 max.	volts
Heater positive with respect to cathode	200 ^c max.	volts

Direct Interelectrode Capacitances:^d

Triode Unit:

G _T to P _T	1.6	pf
Input: G _T to (K _T , G _{3P} + K _P + I _S , H)	3.2	pf
Output: P _T to (K _T , G _{3P} + K _P + I _S , H)	1.8	pf

Pentode Unit:

G _{1P} to P _P	0.01 max.	pf
Input: G _{1P} to (K _P + G _{3P} + I _S , G _{2P} , H)	5.5	pf
Output: P _P to (K _P + G _{3P} + I _S , G _{2P} , H)	3.4	pf
Heater to cathode (Each Unit)	3.2	pf

Characteristics, Class A₁ Amplifier:

	<i>Triode Unit</i>	<i>Pentode Unit</i>	
Plate Voltage	125	125	volts
Grid-No.2 Voltage	-	125	volts
Grid-No.1 Voltage	-1	-1	volt
Amplification Factor	46	-	
Plate Resistance (Approx.)	5400	20000	ohms
Transconductance	8500	7500	μmhos
Plate Current	13.5	12	ma
Grid-No.2 Current	-	4	ma
Grid-No.1 Voltage (Approx.) for plate μa = 10	-8	-8	volts

Mechanical:

Operating Position	Any
Type of Cathodes	Coated Unipotential
Maximum Overall Length	2-3/16"
Maximum Seated Length	1-15/16"
Length, Base Seat to Bulb Top (Excluding tip)	1-9/16" ± 3/32"
Diameter	0.750" to 0.875"
Dimensional Outline	See <i>General Section</i>
Bulb	T6-1/2
Base	Small-Button Noval 9-Pin (JEDEC No. E9-1)



6KZ8

Basing Designation for BOTTOM VIEW. 9FZ

- Pin 1 - Triode Plate
- Pin 2 - Pentode
Grid No.1
- Pin 3 - Pentode
Cathode,
Pentode
Grid No.3,
Internal
Shield
- Pin 4 - Heater

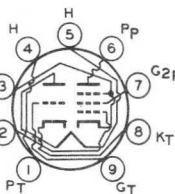

- Pin 5 - Heater
- Pin 6 - Pentode
Plate
- Pin 7 - Pentode
Grid No.2
- Pin 8 - Triode
Cathode
- Pin 9 - Triode
Grid

AMPLIFIER — Class A₁

Maximum Ratings, Design-Maximum Values:

	Triode Unit	Pentode Unit	
Plate Voltage.	330 max.	330 max.	volts
Grid-No.2 (Screen-Grid)			
Supply Voltage	-	330 max.	volts
Grid-No.2 Voltage.	See <i>Grid-No.2 Input Rating Chart</i> at front of Receiving Tube Section		
Grid-No.1 (Control-Grid)			
Voltage:			
Positive-bias value.	0 max.	0 max.	volts
Plate Dissipation.	2.5 max.	2.5 max.	watts
Grid-No.2 Input:			
For grid-No.2 voltages up to 165 volts.	-	0.55 max.	watt
For grid-No.2 voltages between 165 and 330 volts.	See <i>Grid-No.2 Input Rating Chart</i> at front of Receiving Tube Section		

Maximum Circuit Values:

Grid-No.1-Circuit Resistance:

- For fixed-bias
operation. 0.25 max. 0.25 max. megohm
- For cathode-bias
operation. 0.5 max. 0.5 max. megohm

- ^a At heater amperes = 0.450.
- ^b At heater volts = 6.3.
- ^c The dc component must not exceed 100 volts.
- ^d With external shield JEDEC No.315 connected to cathode of unit under test.



AVERAGE PLATE CHARACTERISTICS

Triode Unit

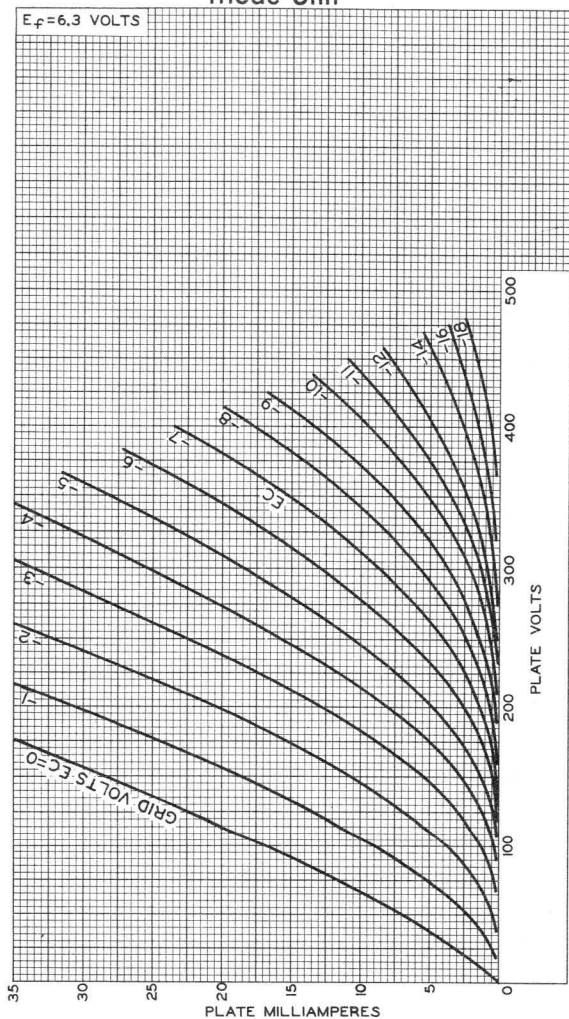

92CM-10421R



6KZ8

AVERAGE CHARACTERISTICS Triode Unit

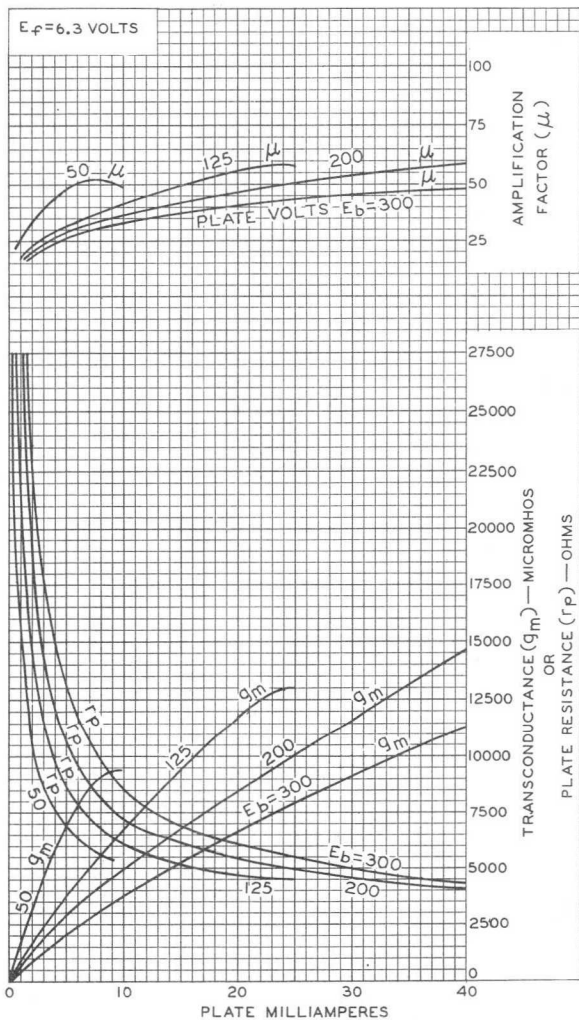

ELECTRON TUBE DIVISION

92CM-10428

RADIO CORPORATION OF AMERICA, HARRISON, NEW JERSEY

RADIO CORPORATION OF AMERICA
Electronic Components and Devices

Harrison, N. J.



AVERAGE CHARACTERISTICS Pentode Unit

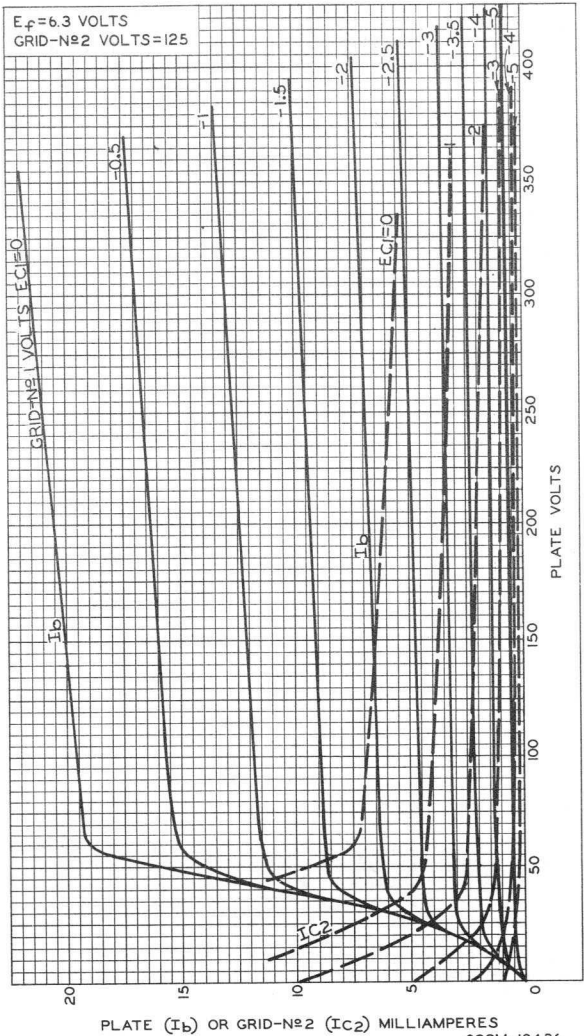

6KZ8

AVERAGE CHARACTERISTICS Pentode Unit

$E_f = 6.3$ VOLTS
PLATE VOLTS = 125
GRID-N \circ 2 VOLTS = 125

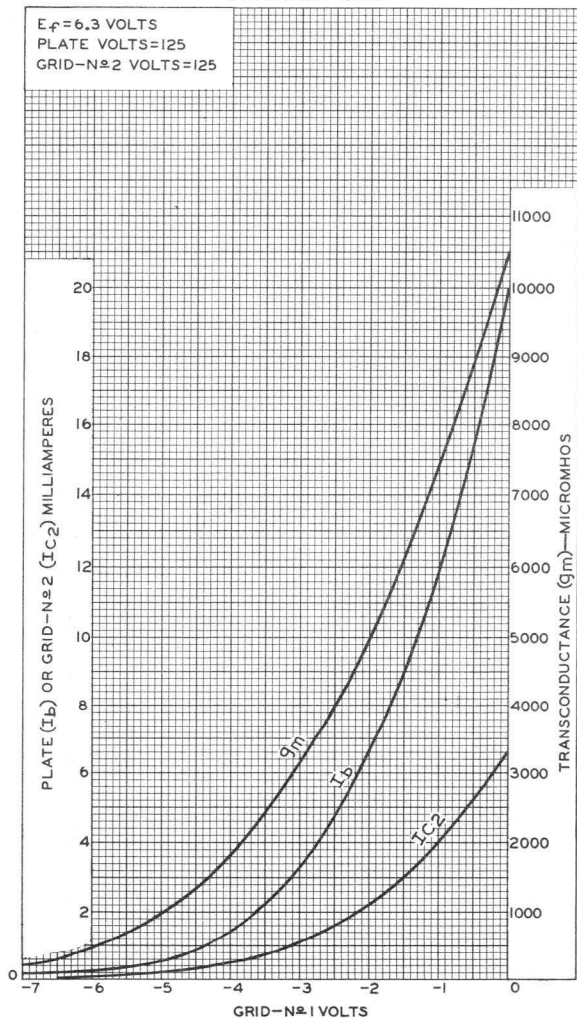

92CM-10417

RADIO CORPORATION OF AMERICA
Electronic Components and Devices

Harrison, N. J.



6L6
6L6-G

6L6, 6L6-G

BEAM POWER TUBE

GENERAL DATA

Electrical:

Heater, for Unipotential Cathode:

Voltage 6.3 ac or dc volts
Current 0.9 amp

Direct Interelectrode Capacitances (Approx.):

	6L6 ^o	6L6-G ^{oo}	
Grid No.1 to plate . .	0.4	0.9	μf
Grid No.1 to cathode & grid No.3, grid No.2, and heater	10	11.5	μf
Plate to cathode & grid No.3, grid No.2, and heater	12	9.5	μf

Mechanical:

	6L6	6L6-G
Mounting Position	Any	Any
Maximum Overall Length . .	4-5/16"	5-5/16"
Maximum Seated Length . .	3-3/4"	4-3/4"
Maximum Diameter	1-5/8"	2-1/16"
Bulb	Metal Shell MT-10	ST-16
Base	Small-Wafer Octal 7-Pin (JETEC No. B7-22)	Medium-Shell Octal 7-Pin (JETEC No. B7-12)
Basing Designation	7AC	G-7AC

Pin 1 { 6L6, Shell
6L6-G, No Conn.
Pin 2 - Heater
Pin 3 - Plate

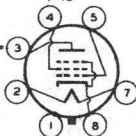

Pin 4 - Grid No.2
Pin 5 - Grid No.1
Pin 7 - Heater
Pin 8 - Cathode,
Grid No.3

AF POWER AMPLIFIER - Class A₁†

Triode Connection - Grid No.2 Connected to Plate

Maximum Ratings, Design-Center Values:

PLATE VOLTAGE	275 max.	volts
PLATE DISSIPATION	19 max.	watts
PEAK HEATER-CATHODE VOLTAGE:		
Heater negative with respect to cathode . .	180 max.	volts
Heater positive with respect to cathode . .	180 max.	volts

Typical Operation and Characteristics:

	Fixed Bias	Cathode Bias	
Plate Voltage	250	250	volts
Grid-No.1 (Control-Grid) Voltage	-20	-	volts
Cathode-Bias Resistor	-	490	ohms

^{o, oo, †}: See next page.

← Indicates a change.

6L6
6L6-G



6L6, 6L6-G

BEAM POWER TUBE

	Fixed Bias	Cathode Bias	
Peak AF Grid-No.1 Voltage . . .	20	20	volts
Zero-Signal Plate Current . . .	40	40	ma
Max.-Signal Plate Current . . .	44	42	ma
Amplification Factor	8	-	
Plate Resistance (Approx.) . . .	1700	-	ohms
Transconductance	4700	-	μ mhos
Load Resistance	5000	6000	ohms
Total Harmonic Distortion . . .	5	6	%
Max.-Signal Power Output	1.4	1.3	watts

→ **Maximum Circuit Values (For maximum rated conditions):**

Grid-No.1-Circuit Resistance:

For fixed-bias operation	0.1 max.	megohm
For cathode-bias operation	0.5 max.	megohm

AF POWER AMPLIFIER - Class A₁†

Maximum Ratings, Design-Center Values:

PLATE VOLTAGE	360 max.	volts
GRID-No.2 (SCREEN) VOLTAGE	270 max.	volts
PLATE DISSIPATION	19 max.	watts
GRID-No.2 INPUT	2.5 max.	watts
PEAK HEATER-CATHODE VOLTAGE:		
Heater negative with respect to cathode .	180 max.	volts
Heater positive with respect to cathode .	180 max.	volts

→ **Typical Operation and Characteristics:**

Fixed-Bias Operation

Plate Voltage	200	250	300	350	volts
Grid-No.2 Voltage	200	250	200	250	volts
Grid-No.1 Voltage	-11.5	-14	-12.5	-18	volts
Peak AF Grid-No.1 Voltage .	11.5	14	12.5	18	volts
Zero-Signal Plate Current .	52	72	48	54	ma
Max.-Signal Plate Current .	57	79	55	66	ma
Zero-Signal Grid-No.2					
Current	3.5	5.0	2.5	2.5	ma
Max.-Signal Grid-No.2					
Current	5.7	7.3	4.7	7.0	ma
Plate Resistance (Approx.)	35000	22500	35000	33000	ohms
Transconductance	5300	6000	5300	5200	μ mhos
Load Resistance	3000	2500	4500	4200	ohms
Total Harmonic Distortion .	9	10	11	15	%
Max.-Signal Power Output .	4	6.5	6.5	10.8	watts

Cathode-Bias Operation

Plate Voltage	200	250	300	volts
Grid-No.2 Voltage	200	250	200	volts

° With shell connected to cathode.

∞∞ With no external shield.

†: See next page.

→ Indicates a change.

6L6
6L6-G

6L6, 6L6-G

BEAM POWER TUBE

Cathode-Bias Resistor	186	167	218	ohms
Peak AF Grid-No.1 Voltage	11.5	14	12.7	volts
Zero-Signal Plate Current	55	75	51	ma
Max.-Signal Plate Current	56	78	54.5	ma
Zero-Signal Grid-No.2 Current	4.2	5.4	3.0	ma
Max.-Signal Grid-No.2 Current	5.6	7.2	4.6	ma
Load Resistance	3000	2500	4500	ohms
Total Harmonic Distortion	9	10	11	%
Max.-Signal Power Output	4	6.5	6.5	watts

Maximum Circuit Values (For maximum rated conditions):

Grid-No.1-Circuit Resistance:

For fixed-bias operation	0.1 max.	megohm
For cathode-bias operation	0.5 max.	megohm

PUSH-PULL AF POWER AMPLIFIER - Class A₁†**Maximum Ratings, Design-Center Values:**

PLATE VOLTAGE	360 max.	volts
GRID-No.2 (SCREEN) VOLTAGE	270 max.	volts
PLATE DISSIPATION	19 max.	watts
GRID-No.2 INPUT	2.5 max.	watts
PEAK HEATER-CATHODE VOLTAGE:		
Heater negative with respect to cathode	180 max.	volts
Heater positive with respect to cathode	180 max.	volts

Typical Operation and Characteristics:*Unless otherwise specified, values are for 2 tubes*

	Fixed Bias		Cathode Bias		
Plate Voltage	250	270	250	270	volts
Grid-No.2 Voltage	250	270	250	270	volts
Grid-No.1 Voltage	-16	-17.5	-	-	volts
Cathode-Bias Resistor	-	-	124	124	ohms
Peak AF Grid-No.1-to-					
Grid-No.1 Voltage	32	35	35.6	28.2	volts
Zero-Signal Plate Current	120	134	120	134	ma
Max.-Signal Plate Current	140	155	130	145	ma
Zero-Signal Grid-No.2					
Current	10	11	10	11	ma
Max.-Signal Grid-No.2					
Current	16	17	15	17	ma
Plate Resistance (Per tube)					
(Approx.)	24500	23500	-	-	ohms
Transconductance (Per tube)					
	5500	5700	-	-	μmhos
Effective Load Resistance					
(Plate to plate)	5000	5000	5000	5000	ohms
Total Harmonic Distortion	2	2	2	2	%
Max.-Signal Power Output	14.5	17.5	13.8	18.5	watts

†: See next page.

←Indicates a change

6L6
6L6-G



6L6, 6L6-G BEAM POWER TUBE

→ **Maximum Circuit Values (For maximum rated conditions):**

Grid-No.1-Circuit Resistance:

For fixed-bias operation 0.1 max. megohm
For cathode-bias operation 0.5 max. megohm

PUSH-PULL AF POWER AMPLIFIER - Class AB₁†

Maximum Ratings, Design-Center Values:

PLATE VOLTAGE 360 max. volts
GRID-No.2 (SCREEN) VOLTAGE 270 max. volts
PLATE DISSIPATION 19 max. watts
GRID-No.2 INPUT 2.5 max. watts

→ **PEAK HEATER-CATHODE VOLTAGE:**

Heater negative with respect to cathode . . . 180 max. volts
Heater positive with respect to cathode . . . 180 max. volts

→ **Typical Operation:**

Values are for 2 tubes

	<i>Fixed Bias</i>	<i>Cathode Bias</i>		
Plate Voltage	360	360	360	volts
Grid-No.2 Voltage	270	270	270	volts
Grid-No.1 Voltage▲	-22.5	-22.5	-	volts
Cathode-Bias Resistor	-	-	248	ohms
Peak AF Grid-No.1-to-				
Grid-No.1 Voltage	45	45	40.6	volts
Zero-Signal Plate Current	88	88	88	ma
Max.-Signal Plate Current	132	140	100	ma
Zero-Signal Grid-No.2				
Current	5	5	5	ma
Max.-Signal Grid-No.2				
Current	15	11	17	ma
Effective Load Resistance (Plate to plate).	6600	3800	9000	ohms
Total Harmonic Distortion	2	2	4	%
Max.-Signal Power Output	26.5	18	24.5	watts

→ **Maximum Circuit Values (For maximum rated conditions):**

Grid-No.1-Circuit Resistance:▲

For fixed-bias operation 0.1 max. megohm
For cathode-bias operation 0.5 max. megohm

PUSH-PULL AF POWER AMPLIFIER - Class AB₂‡

Maximum Ratings, Design-Center Values:

PLATE VOLTAGE 360 max. volts
GRID-No.2 (SCREEN) VOLTAGE 270 max. volts
PLATE DISSIPATION 19 max. watts
GRID-No.2 INPUT 2.5 max. watts

▲, †, ‡: See next page.

→ indicates a change.

6L6
6L6-G

6L6, 6L6-G

BEAM POWER TUBE

PEAK HEATER-CATHODE VOLTAGE:

Heater negative with respect to cathode. . . 180 max. volts
 Heater positive with respect to cathode. . . 180 max. volts

Typical Operation:*Values are for 2 tubes*

	<i>Fixed Bias</i>		
Plate Voltage.	360	360	volts
Grid-No.2 Voltage.	225	270	volts
Grid-No.1 Voltage.	-18	-22.5	volts
Peak AF Grid-No.1-to Grid-No.1 Voltage	52	72	volts
Zero-Signal Plate Current.	78	88	ma
Max.-Signal Plate Current.	142	205	ma
Zero-Signal Grid-No.2 Current.	3.5	5	ma
Max.-Signal Grid-No.2 Current.	11	16	ma
Effective Load Resistance (Plate to plate).	6000	3800	ohms
Peak Grid-Input Power.	140	270	mw
Total Harmonic Distortion.	2	2	%
Max.-Signal Power Output	31	47	watts

Maximum Circuit Values (For maximum rated conditions):**Grid-No.1-Circuit Resistance[†]:**

For fixed-bias operation 0.1 max. megohm
 For cathode-bias operation Not recommended

[†] Subscript 1 indicates that grid-No.1 current does not flow during any part of input cycle.

[‡] Subscript 2 indicates that grid-No.1 current flows during some part of input cycle.

[‡] Driver stage should be capable of supplying the specified driving power at low distortion to the No.1 grids of the AB₂ stage. To minimize distortion, the effective resistance per grid-No.1 circuit of the AB₂ stage should be held at a low value. For this purpose, the use of transformer coupling is recommended.

[▲] The type of input coupling used should not introduce too much resistance in the grid-No.1 circuit. Transformer- or impedance-coupling devices are recommended.

←Indicates a change.

6L6



6L6

AVERAGE PLATE CHARACTERISTICS TRIODE CONNECTION

$E_f = 6.3$ VOLTS
GRID NO 2 CONNECTED TO PLATE

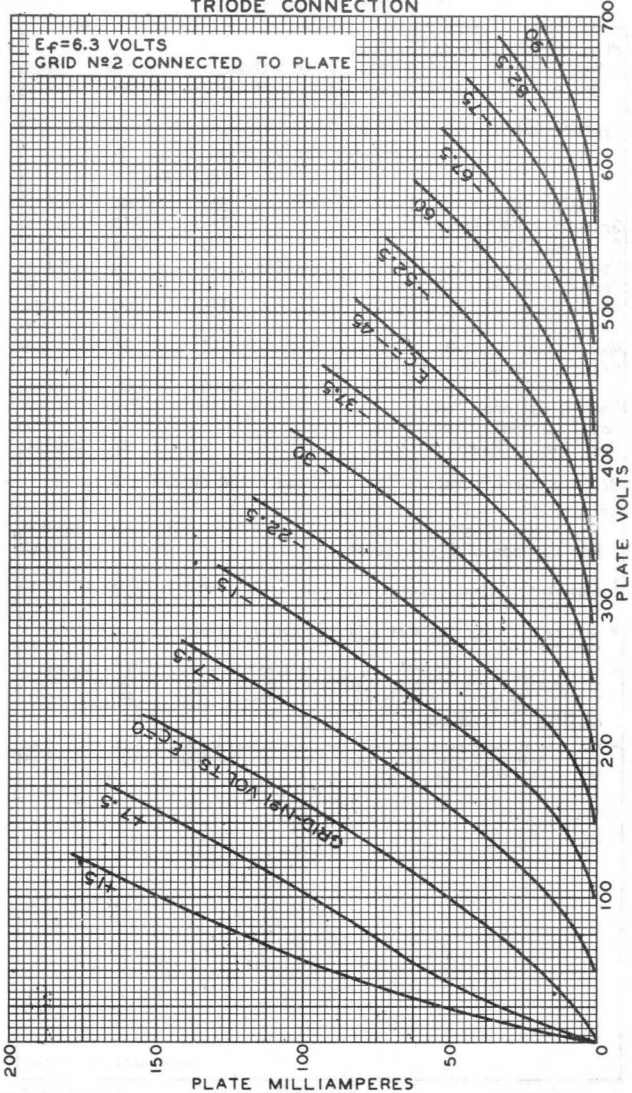

SEPT. 6 1938

PLATE DIVISION
RADIO CORPORATION OF AMERICA, HARRISON, NEW JERSEY

92CM-4966RI



6L6

AVERAGE PLATE CHARACTERISTICS WITH E_{C1} AS VARIABLE

6L6

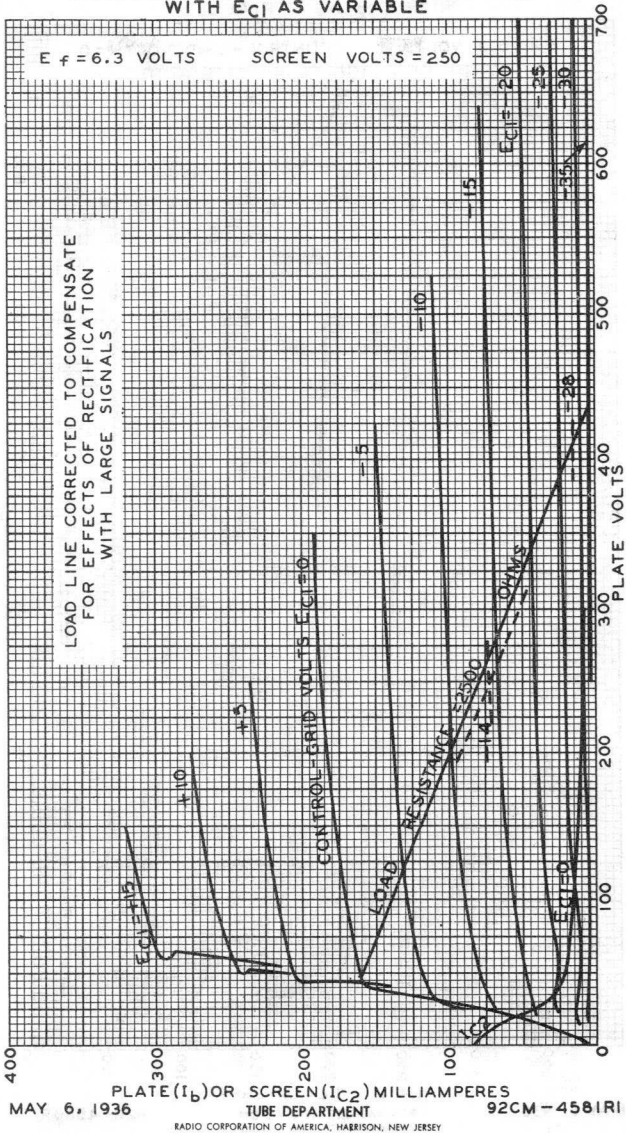

6L6



6L6

AVERAGE PLATE CHARACTERISTICS WITH E_{C2} AS VARIABLE

$E_f = 6.3$ VOLTS

CONTROL-GRID VOLTS = 0

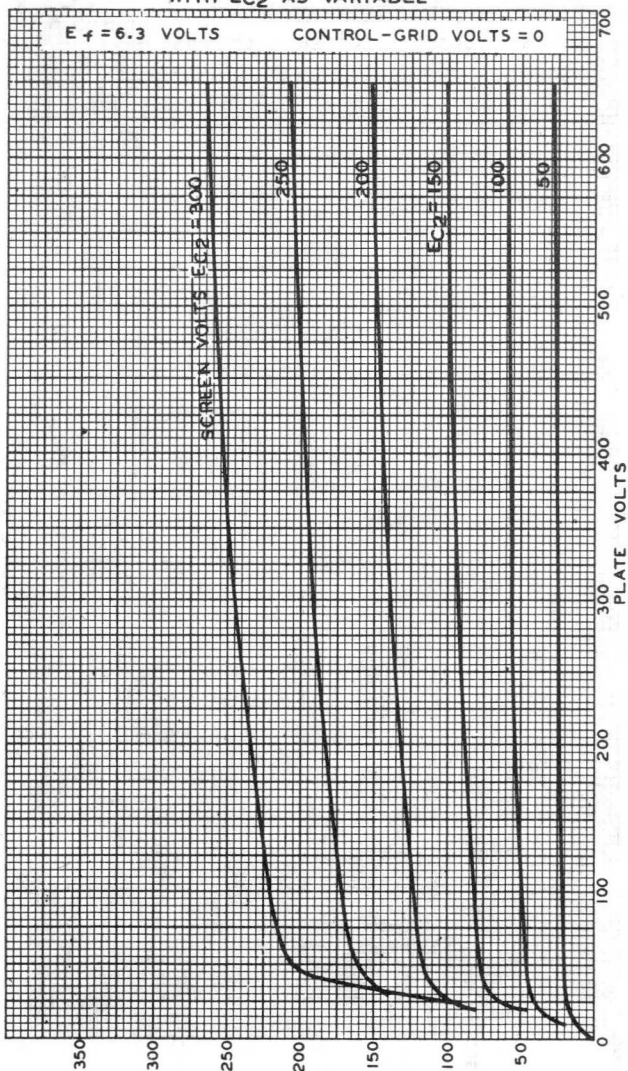

MAY 8, 1936

RCA RADOTRON DIVISION
RCA MANUFACTURING COMPANY, INC.

92C-4580R1



6L6

6L6

OPERATION CHARACTERISTICS

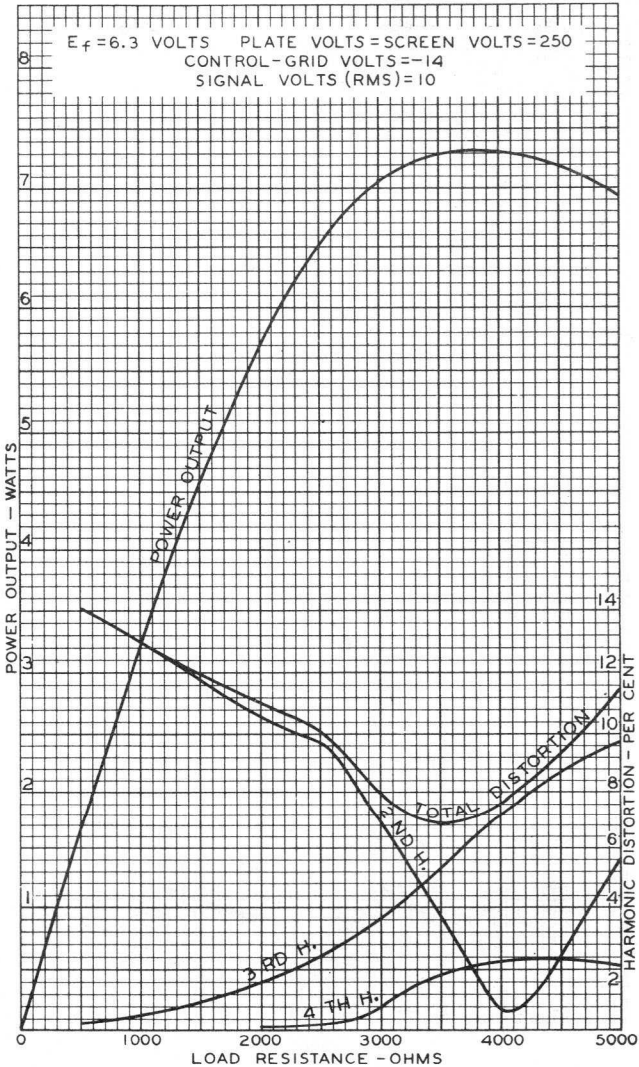

MAY 7, 1936

RCA RADOTRON DIVISION
RCA MANUFACTURING COMPANY, INC.

92C-4608

6L6



6L6

OPERATION CHARACTERISTICS

$E_f = 6.3$ VOLTS PLATE VOLTS = SCREEN VOLTS = 250
 CONTROL-GRID VOLTS = -14
 LOAD RESISTANCE (OHMS) = 2500

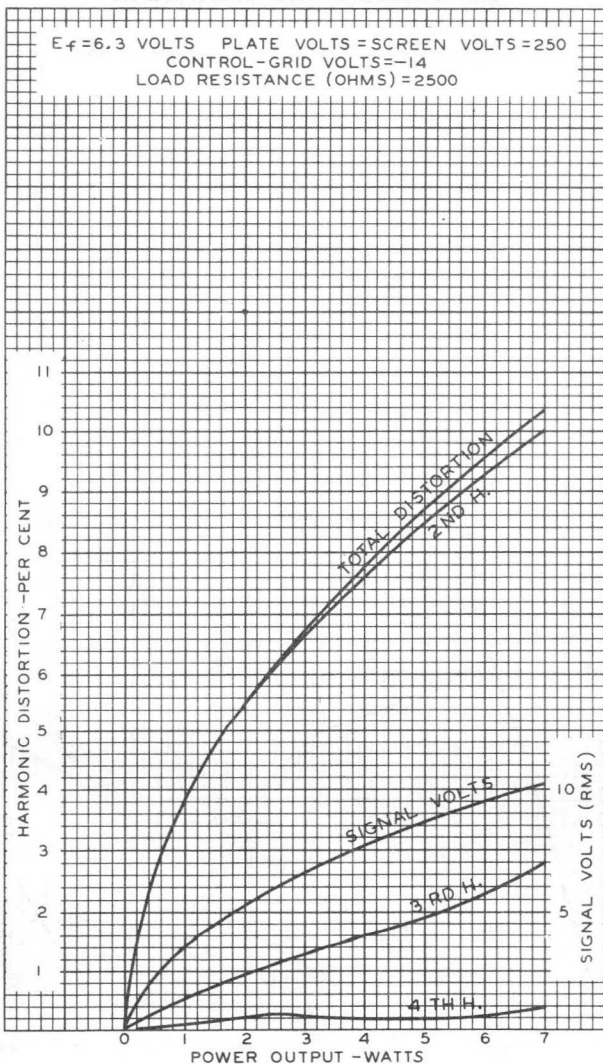

Beam Power Tube

GENERAL DATA

Electrical:

Heater, for Unipotential Cathode:

Voltage (AC or DC)	6.3 ± 10%	volts
Current at 6.3 volts.	0.9	amp

Direct Interelectrode Capacitances
(Approx.):[▲]

Grid-No.1 to plate.	0.6	μf
Grid-No.1 to cathode & grid No.3, grid No.2, and heater	10	μf
Plate to cathode & grid No.3, grid No.2, and heater	6.5	μf

Characteristics, Class A₁ Amplifier:

Plate Voltage	250	volts
Grid-No.2 Voltage	250	volts
Grid-No.1 Voltage	-14	volts
Plate Resistance (Approx.)	22500	ohms
Transconductance.	6000	μmhos
Plate Current	72	ma
Grid-No.2 Current	5	ma

Mechanical:

Operating Position.	Any
Maximum Overall Length.	4-1/4"
Maximum Seated Length	3-11/16"
Diameter.	1.438" to 1.562"
Bulb.	T-12
Base.	Medium-Shell Octal 7-Pin (JEDEC Group 1, No.B7-12), Short Medium-Shell Octal 7-Pin with External Barriers Style A (JEDEC Group 1, No.B7-111) or Style B (JEDEC Group 1, No.B7-119), or Short Medium-Shell Octal 6-Pin with External Barriers Style A (JEDEC Group 1, No.B6-148) or Style B (JEDEC Group 1, No.B6-122)

Basing Designation for BOTTOM VIEW. 7AC

- Pin 1 • - No Connection
- Pin 2 - Heater
- Pin 3 - Plate
- Pin 4 - Grid No.2

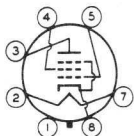

- Pin 5 - Grid No.1
- Pin 7 - Heater
- Pin 8 - Cathode,
Grid No.3

AF POWER AMPLIFIER — Class A₁

Maximum Ratings, Design-Maximum Values:

PLATE VOLTAGE.	500	max.	volts
GRID-No.2 (SCREEN-GRID) VOLTAGE.	450	max.	volts
GRID-No.2 INPUT.	5	max.	watts
PLATE DISSIPATION.	30	max.	watts



6L6-GC

PEAK HEATER-CATHODE VOLTAGE:

Heater negative with respect to cathode. . 200 max. volts
 Heater positive with respect to cathode. . 200* max. volts

Typical Operation and Characteristics:

Fixed-Bias Operation

Plate Voltage.	200	250	300	350	volts
Grid-No.2 Voltage.	200	250	200	250	volts
Grid-No.1 (Control-Grid)					
Voltage.	-11.5	-14	-12.5	-18	volts
Peak AF Grid-No.1 Voltage.	11.5	14	12.5	18	volts
Zero-Signal Plate Current.	52	72	48	54	ma
Max.-Signal Plate Current.	57	79	55	66	ma
Zero-Signal Grid-No.2					
Current.	3.5	5	2.5	2.5	ma
Max.-Signal Grid-No.2					
Current.	5.7	7.3	4.7	7	ma
Plate Resistance (Approx.).	35000	22500	35000	33000	ohms
Transconductance	5300	6000	5300	5200	μmhos
Load Resistance.	3000	2500	4500	4200	ohms
Total Harmonic Distortion.	9	10	11	15	%
Max.-Signal Power Output .	4	6.5	6.5	10.8	watts

Cathode-Bias Operation

Plate Supply Voltage	200	250	300	volts
Grid-No.2 Supply Voltage	200	250	200	volts
Cathode Resistor	186	167	218	ohms
Peak AF Grid-No.1 Voltage.	11.5	14	12.7	volts
Zero-Signal Plate Current.	55	75	51	ma
Max.-Signal Plate Current.	56	78	54.5	ma
Zero-Signal Grid-No.2 Current.	4.2	5.4	3	ma
Max.-Signal Grid-No.2 Current.	5.6	7.2	4.6	ma
Load Resistance.	3000	2500	4500	ohms
Total Harmonic Distortion.	9	10	11	%
Max.-Signal Power Output	4	6.5	6.5	watts

Maximum Circuit Values:

Grid-No.1-Circuit Resistance:

For fixed-bias operation 0.1 max. megohm
 For cathode-bias operation 0.5 max. megohm

AF POWER AMPLIFIER — Class A₁

Triode Connection — Grid No.2 Connected to Plate

Maximum Ratings, Design-Maximum Values:

PLATE VOLTAGE. 450 max. volts
 PLATE DISSIPATION. 30 max. watts

PEAK HEATER-CATHODE VOLTAGE:

Heater negative with respect to cathode. . 200 max. volts
 Heater positive with respect to cathode. . 200* max. volts



Typical Operation and Characteristics:

	Fixed Bias	Cathode Bias	
Plate Supply Voltage.	250	250	volts
Grid-No.1 (Control-Grid) Voltage. . .	-20	-	volts
Cathode Resistor.	-	490	ohms
Peak AF Grid-No.1 Voltage	20	20	volts
Zero-Signal Plate Current	40	40	ma
Maximum-Signal Plate Current.	44	42	ma
Plate Resistance (Approx.).	1700	-	ohms
Amplification Factor.	8	-	
Transconductance.	4700	-	μmhos
Load Resistance	5000	6000	ohms
Total Harmonic Distortion	5	6	%
Maximum-Signal Power Output	1.4	1.3	watts

Maximum Circuit Values:

Grid-No.1-Circuit Resistance:

For fixed-bias operation.	0.1 max.	megohm
For cathode-bias operation.	0.5 max.	megohm

PUSH-PULL AF POWER AMPLIFIER — Class A₁

Maximum Ratings, Design-Maximum Values:

PLATE VOLTAGE.	500 max.	volts
GRID-No.2 (SCREEN-GRID) VOLTAGE.	450 max.	volts
GRID-No.2 INPUT.	5 max.	watts
PLATE DISSIPATION.	30 max.	watts
PEAK HEATER-CATHODE VOLTAGE:		
Heater negative with respect to cathode. .	200 max.	volts
Heater positive with respect to cathode. .	200* max.	volts

Typical Operation and Characteristics:

Unless otherwise specified, values are for 2 tubes

	Fixed Bias		Cathode Bias		
Plate Supply Voltage.	250	270	250	270	volts
Grid-No.2 Supply Voltage.	250	270	250	270	volts
Grid-No.1 Voltage	-16	-17.5	-	-	volts
Cathode Resistor.	-	-	124	124	ohms
Peak AF Grid-No.1-to-					
Grid-No.1 Voltage	32	35	35.6	28.2	volts
Zero-Signal Plate Current.	120	134	120	134	ma
Max.-Signal Plate Current	140	155	130	145	ma
Zero-Signal Grid-No.2					
Current	10	11	10	11	ma
Max.-Signal Grid-No.2					
Current	16	17	15	17	ma
Plate Resistance (Approx., per tube)	24500	23500	-	-	ohms
Transconductance (Per tube).	5500	5700	-	-	μmhos
Effective Load Resistance (Plate to plate).	5000	5000	5000	5000	ohms
Total Harmonic Distortion	2	2	2	2	%
Max.-Signal Power Output.	14.5	17.5	13.8	18.5	watts



6L6-GC

Maximum Circuit Values:

Grid-No.1-Circuit Resistance:
 For fixed-bias operation. 0.1 max. megohm
 For cathode-bias operation. 0.5 max. megohm

PUSH-PULL AF POWER AMPLIFIER — Class AB₁

Maximum Ratings, Design-Maximum Values:

PLATE VOLTAGE 500 max. volts
 GRID-No.2 VOLTAGE 450 max. volts
 GRID-No.2 INPUT 5 max. watts
 PLATE DISSIPATION 30 max. watts
 PEAK HEATER-CATHODE VOLTAGE:
 Heater negative with respect to cathode . 200 max. volts
 Heater positive with respect to cathode . 200* max. volts

Typical Operation:

Values are for 2 tubes

	Fixed Bias			Cathode	
				Bias	
Plate Supply Voltage.	360	450	450	360	volts
Grid-No.2 Supply Voltage.	270	350	400	270	volts
Grid-No.1 (Control-Grid) Voltage.	-22.5	-30	-37	-	volts
Cathode Resistor.	-	-	-	248	ohms
Peak Af Grid-No.1-to-					
Grid-No.1 Voltage	45	60	70	40.6	volts
Zero-Signal Plate Current.	88	95	116	88	ma
Max.-Signal Plate Current	132	194	210	100	ma
Zero-Signal Grid-No.2 Current	5	3.4	5.6	5	ma
Max.-Signal Grid-No.2 Current	15	19.2	22	17	ma
Effective Load Resistance (Plate to plate).	6600	6000	5600	9000	ohms
Total Harmonic Distortion	2	1.5	1.8	4	%
Max.-Signal Power Output.	26.5	50	55	24.5	watts

Maximum Circuit Values:

Grid-No.1-Circuit Resistance:
 For fixed-bias operation. 0.1 max. megohm
 For cathode-bias operation. 0.5 max. megohm

PUSH-PULL AF AMPLIFIER — Class AB₂

Maximum Ratings, Design-Maximum Values:

PLATE VOLTAGE 500 max. volts
 GRID-No.2 (SCREEN-GRID) VOLTAGE. 450 max. volts
 GRID-No.2 INPUT 5 max. watts
 PLATE DISSIPATION 30 max. watts
 PEAK HEATER-CATHODE VOLTAGE:
 Heater negative with respect to cathode . 200 max. volts
 Heater positive with respect to cathode . 200* max. volts



Typical Operation:

Values are for 2 tubes

	Fixed Bias		
Plate Voltage.	360	360	volts
Grid-No.2 Voltage.	225	270	volts
Grid-No.1 (Control-Grid) Voltage [♣]	-18	-22.5	volts
Peak AF Grid-No.1 to Grid-No.1 Voltage.	52	72	volts
Zero-Signal Plate Current.	78	88	ma
Max.-Signal Plate Current.	142	205	ma
Zero-Signal Grid-No.2 Current.	3.5	5	ma
Max.-Signal Grid-No.2 Current.	11	16	ma
Effective Load Resistance (Plate to plate).	6000	3800	ohms
Peak Grid-Input Power [♣]	140	270	mw
Total Harmonic Distortion.	2	2	%
Max.-Signal Power Output	31	47	watts

Maximum Circuit Values:

Grid-No.1-Circuit Resistance: [♣]	
For fixed-bias operation	0.1 max. megohm
For cathode-bias operation	Not recommended

[♣] Without external shield.

• On the 6-pin bases, pin 1 as well as pin 6 is omitted.

★ The dc component must not exceed 100 volts.

♣ In push-pull circuits where grid No.2 of each tube is connected to a tap on the plate winding of the output transformer, it is permissible for this voltage to be as high as 500 volts.

♣ The type of input coupling used should not introduce too much resistance in the grid-No.1 circuit. Transformer- or impedance-coupling devices are recommended.

♣ Driver stage should be capable of supplying the specified driving power at low distortion to the No.1 grids of the AB₂ stage. To minimize distortion, the effective resistance per grid-No.1 circuit of the AB₂ stage should be held at a low value. For this purpose, the use of transformer coupling is recommended.

OPERATING CONSIDERATIONS

The *bulb* becomes hot during operation. To insure adequate cooling, therefore, it is essential that free circulation of air be provided.



6L6-GC

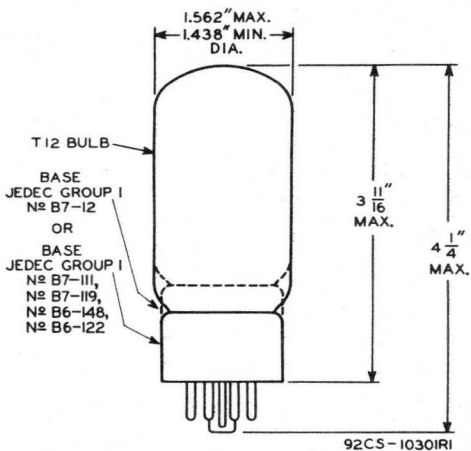

AVERAGE PLATE CHARACTERISTICS

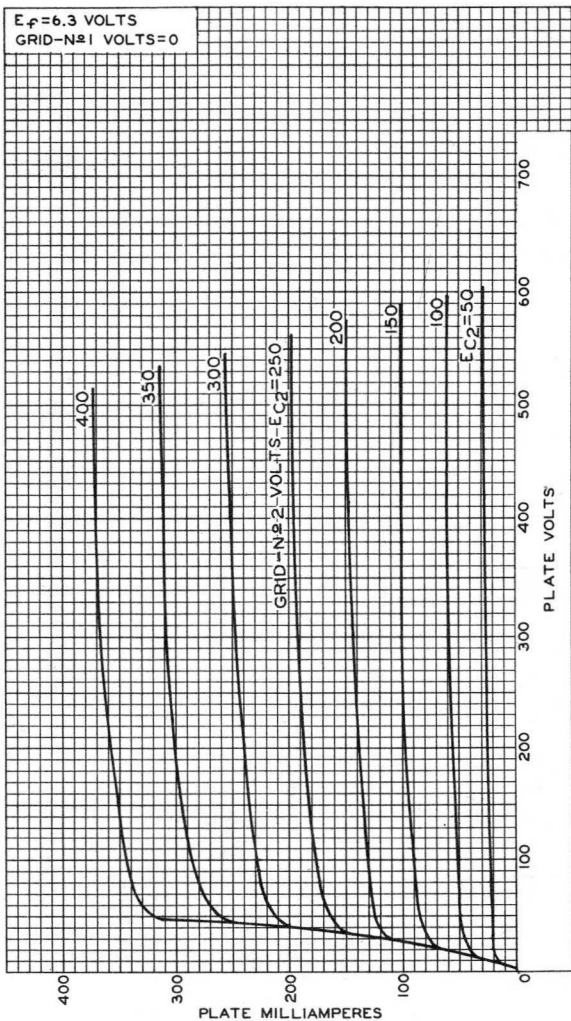

92CM-10327



6L6-GC

AVERAGE CHARACTERISTICS

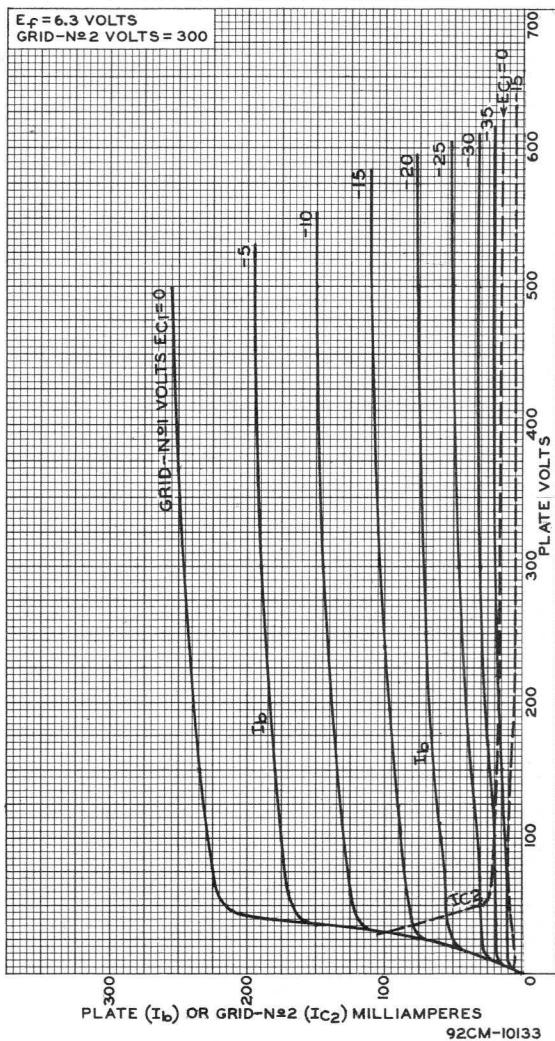

AVERAGE PLATE CHARACTERISTICS Triode Connection

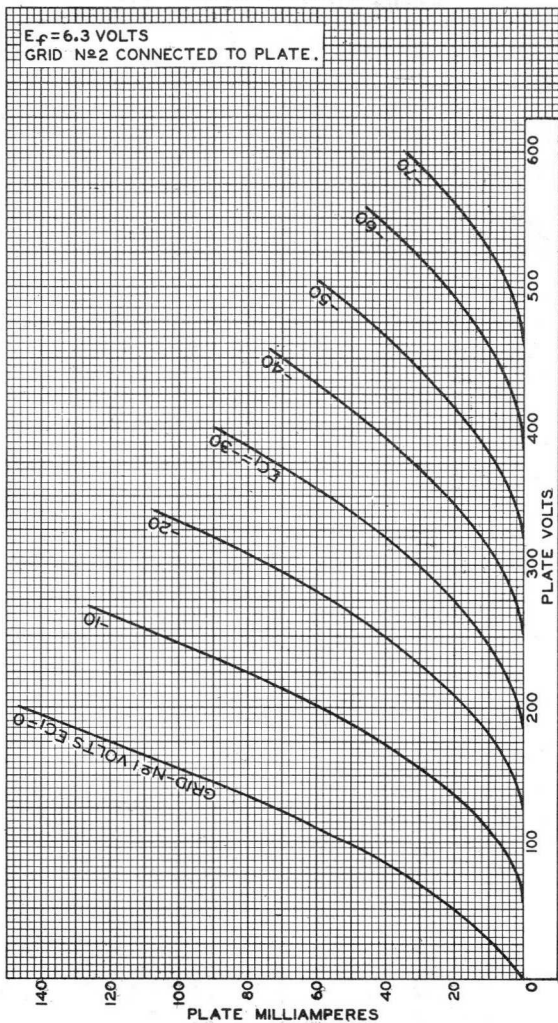

92CM-9568



AVERAGE CHARACTERISTICS

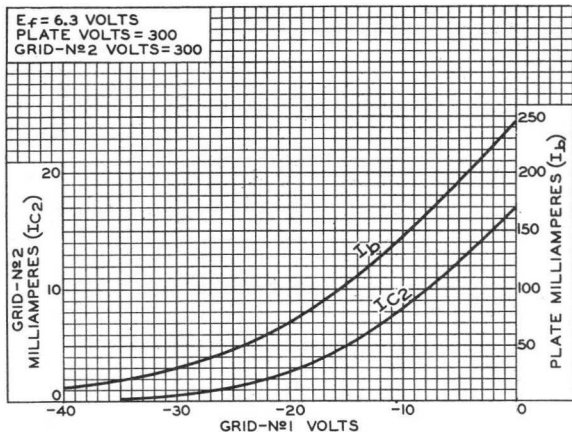

92CS-10126

OPERATION CHARACTERISTICS Push-Pull Class AB₁

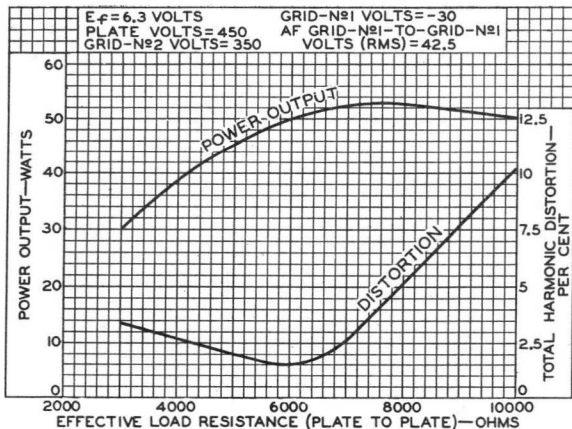

92CS-9575



Beam Power Tube

Duodecar Type

For Color-TV Horizontal-Deflection Amplifier
Circuits Using 240 V to over 400 V "B" Supplies

ELECTRICAL CHARACTERISTICS – Bogey Values

Heater Voltage, ac or dc.	E_h	6.3	V
Heater Current	I_h	2.25	A
Direct Interelectrode Capacitances: ^a			
Grid No.1 to plate	c_{g1-p}	0.44	pF
Input: G1 to (K, G3, G2, H)	c_i	33	pF
Output: P to (K, G3, G2, H)	c_o	18	pF

For the following characteristics, see Conditions below:

Amplification Factor

(Triode Connection) ^b	μ	—	—	—	4 ^c
Plate Resistance (approx.)	r_p	—	—	—	6600 Ω
Transconductance	g_m	—	—	—	13400 μmho
DC Plate Current	I_b	—	900 ^d	560 ^d	105 mA
DC Grid-No.2 Current	I_{c2}	—	110 ^d	46 ^d	2.0 mA
Cutoff DC Grid-No.1 Volt- age for $I_b = 1$ mA	$E_{c1(\text{co})}$	-125	—	—	-40 V

Conditions:

Heater Voltage	E_h	← 6.3 →			V
Peak Positive-Pulse Plate Voltage ^e	e_{bm}	5000	—	—	V
DC Plate Voltage	E_b	—	45	50	150 V
Grid No.3		Connected to cathode at socket			
DC Grid-No.2 Voltage	E_{c2}	110	160	110	110 V
DC Grid-No.1 Voltage	E_{c1}	—	0	—	-20 V

MECHANICAL CHARACTERISTICS

Maximum Overall Length	4.375 in (111.12 mm)
Maximum Seated Length	4.000 in (101.6 mm)
Maximum Diameter	1.563 in (39.7 mm)
Dimensional Outline	JEDEC No.12-90
Envelope	JEDEC T12
Top Cap ^f	Small (JEDEC C1-1 or C1-34)

6LB6

Base Large-Button Duodecar 12-Pin (JEDEC E12-74)
 Terminal Diagram JEDEC 12GJ
 Type of Cathode Coated Unipotential
 Operating Position Any

MAXIMUM RATINGS – Design-Maximum Values⁹

*For operation as a Horizontal-Deflection-Amplifier Tube
 in a 525-line, 30-frame system*

DC Plate Supply Voltage	E_{bb}	990	V
Peak Positive-Pulse Plate Voltage ^h	e_{bm}	7000 ^k	V
Peak Negative-Pulse Plate Voltage	$-e_{bm}$	100	V
DC Grid-No.3 Voltage	E_{c3}	0	V
DC Grid-No.2 (Screen-Grid) Voltage	E_{c2}	200	V
Peak Negative-Pulse Grid-No.1 (Control-Grid) Voltage	$-e_{c1m}$	300	V
Heater-Cathode Voltage:			
Peak	e_{hkm}	±200	V
Average ^m	E_{hk}	100	V
Heater Voltage, ac or dc	E_h	5.7 to 6.9	V
Cathode Current:			
Peak	i_{km}	1100	mA
Average ^m	$I_{k(av)}$	315	mA
Grid-No.2 Input	P_{g2}	5.0	W
Plate Dissipation ⁿ	P_b	30	W
Envelope Temperature	T_E	200 ^p	°C

MAXIMUM CIRCUIT VALUES

Grid-No.1-Circuit Resistance	R_{g1}	1.2	MΩ
With Feedback-Type High Voltage Regulation			
Grid-No.1-Circuit Resistance	R_{g1}	10	MΩ
With Shunt-Type High Voltage Regulation			
Grid-No.3-Circuit Resistance	R_{g3}	0	Ω

^a Measured without external shield in accordance with the current issue of EIA Standard RS-191.

^b With grid No.3 and grid No.2 connected, respectively, to cathode and plate at socket.

- ^c Conditions: $E_b = E_{c2} = 125 \text{ V}$, $E_{c1} = -25 \text{ V}$.
- ^d This value can be measured by a method involving a recurrent waveform such that the Maximum Ratings of the tube will not be exceeded.
- ^e Under pulse-duration condition specified in Footnote h.
- ^f Designed to mate with connector of 0.250-inch cap, generally available from your local RCA distributor.
- ^g As defined in the current issue of EIA Standard RS-239, unless otherwise specified.
- ^h This rating is applicable when the duration of the voltage pulse does not exceed 15% of one horizontal scanning cycle. In a 525-line, 30-frame system, 15% of one horizontal scanning cycle is 10 μs .
- ^k Absolute-Maximum Value.
- ^m Measured with a DC meter.
- ⁿ An adequate bias resistor or other means is required to protect the tube in the absence of excitation.
- ^p This rating is applicable when measurement is made using a thermocouple attached to a 0.1-inch wide phosphor-bronze ring placed at the hottest location on the envelope. A maximum rating of 220°C is applicable to direct thermocouple measurements taken at the hottest point on the envelope surface.

TERMINAL DIAGRAM (Bottom View)

- Pin 1 – Heater
 Pin 2 – Cathode
 Pin 3 – Grid No.2
 Pin 4 – Grid No.3
 Pin 5 – Grid No.1
 Pin 6 – No Internal Connection
 Pin 7 – Do Not Use
 Pin 8 – No Internal Connection
 Pin 9 – Do Not Use
 Pin 10 – Grid No.3
 Pin 11 – Do Not Use
 Pin 12 – Heater
 Cap – Plate

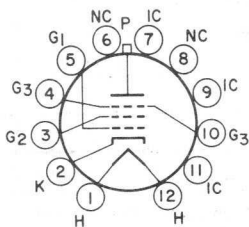

JEDEC 12GJ

6LB6

DIMENSIONAL OUTLINE (JEDEC No.12-90)

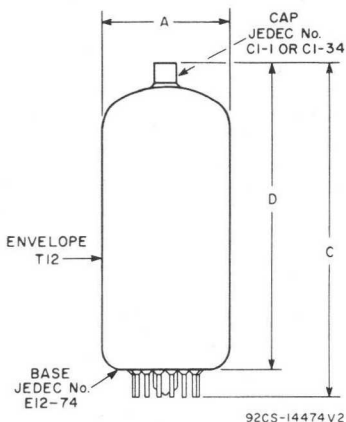

DIMENSION	INCHES		MILLIMETERS	
	Min.	Max.	Min.	Max.
A	1.437*	1.563	36.5*	39.7
C	—	4.375	—	111.12
D	3.750	4.000	95.3	101.6
MILLIMETER DIMENSION DERIVED FROM INCH DIMENSION				
* Applies to the minimum diameter except in the area of the seal.				

High-Mu Triode— Sharp-Cutoff Pentode

9-PIN MINIATURE TYPE

For Sync-Separator and Noise-Immune
Gated-AGC-Amplifier Applications in
Color and Black-and White TV Receivers

GENERAL DATA

Electrical:

Heater Characteristics and Ratings:

Voltage (AC or DC)	6.3 ^a	6.3 ± 0.6	volts
Current	0.600 ± 0.040	0.600 ^b	amp
Warm-up time (Average)	11	—	sec

Peak heater-cathode voltage

(Each unit):

Heater negative with respect to cathode	200 max.	volts
Heater positive with respect to cathode	200 ^c max.	volts

Direct Interelectrode

Capacitances:^d

Triode Unit:

Grid to plate	2.2	pf
Grid to cathode & pentode grid No.3 & internal shield, and heater	2.8	pf
Plate to cathode & pentode grid No.3 & internal shield, and heater	2.2	pf

Pentode Unit:

Grid No.1 to plate	0.1 max.	pf
Grid No.1 to cathode, triode cathode & grid No.3 & internal shield, grid No.2, and heater	10.0	pf
Grid No.3 & triode cathode & internal shield to plate	3.4	pf
Grid No.1 to grid No.3 & triode cathode & internal shield	0.36	pf
Grid No.3 & triode cathode & internal shield to plate, cathode, grid No.2, grid No.1, and heater	12.5	pf

Characteristics, Class A₁ Amplifier:

	Triode Unit	Pentode Unit	
Plate Supply Voltage	200	150	volts
Grid No.3	—	e	



6LC8

	Triode Unit	Pentode Unit	
Grid-No.2 Supply Voltage	-	100	volts
Grid-No.1 Voltage.	-2	-	volts
Grid No.1.	-	e	
Cathode Resistor	-	180	ohms
Amplification Factor	70	-	
Plate Resistance (Approx.)	17500	10000	ohms
Transconductance, Grid No.1 to Plate	4000	4400	μ hos
Transconductance, Grid No.3 to Plate ^f	-	600	μ hos
Plate Current.	4	4	ma
Grid-No.2 Current.	-	2.8	ma
Grid-No.1 Supply Voltage (Approx.) for plate μ a =			
10	-5	-	volts
20	-	-4	volts
Grid-No.3 Supply Voltage (Approx.) for plate μ a = 20 ^f	-	-7	volts

Mechanical:

Operating Position	Any
Type of Cathodes	Coated Unipotential
Maximum Overall Length	2-5/8"
Maximum Seated Length.	2-3/8"
Length, Base Seat to Bulb Top (Excluding tip).	2" \pm 3/32"
Diameter	0.750" to 0.875"
Dimensional Outline.	See <i>General Section</i>
Bulb	T6-1/2
Base	Small-Button Noval 9-Pin (JEDEC No.E9-1)
Basing Designation for BOTTOM VIEW	9QY

- Pin 1 - Triode Plate
- Pin 2 - Triode Grid
- Pin 3 - Triode
Cathode,
Pentode Grid
No.3, Internal
Shield
- Pin 4 - Heater
- Pin 5 - Heater

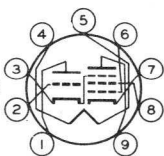

- Pin 6 - Pentode
Grid No.1
- Pin 7 - Pentode
Cathode
- Pin 8 - Pentode
Grid No.2
- Pin 9 - Pentode
Plate

GATED AGC AMPLIFIER & NOISE INVERTER

Pentode Unit

Maximum Ratings, Design-Maximum Values:

For operation in a 525-line, 30-frame system^g

DC PLATE VOLTAGE	300 max.	volts
PEAK POSITIVE-PULSE PLATE VOLTAGE ^h	600 max.	volts



GRID-No.3 (CONTROL-GRID) VOLTAGE:		
Negative-bias value.	100 max.	volts
Positive-bias value.	0 max.	volts
GRID-No.2 (SCREEN-GRID) SUPPLY VOLTAGE	300 max.	volts
GRID-No.2 VOLTAGE.	See <i>Grid-No.2-Input Rating Chart</i> at front of Receiving Tube Section	
GRID-No.1 (CONTROL-GRID) VOLTAGE:		
Negative-bias value.	50 max.	volts
Positive-bias value.	0 max.	volts
GRID-No.2 INPUT:		
For grid-No.2 voltages up to 150 volts.	1.1 max.	watts
For grid-No.2 voltages between 150 and 300 volts.	See <i>Grid-No.2-Input Rating Chart</i> at front of Receiving Tube Section	
PLATE DISSIPATION.	2 max.	watts

Maximum Circuit Values:

Grid-No.1-Circuit Resistance:		
For fixed-bias operation	0.5 max.	megohm
For cathode-bias operation	1 max.	megohm

AMPLIFIER — Class A₁

Triode Unit

Maximum Ratings, Design-Maximum Values:

PLATE VOLTAGE.	300 max.	volts
GRID VOLTAGE:		
Negative-bias value.	50 max.	volts
Positive-bias value.	0 max.	volts
PLATE DISSIPATION.	1.1 max.	watts

Maximum Circuit Values:

Grid-Circuit Resistance:		
For fixed-bias operation	0.25 max.	megohm
For cathode-bias operation	1 max.	megohm

- a At heater amperes = 0.600.
- b At heater volts = 6.3.
- c The dc component must not exceed 100 volts.
- d without external shield.
- e Connected to negative end of cathode resistor.
- f with no external connection to triode plate and triode grid.
- g As described in "Standards of Good Engineering Practice Concerning Television Broadcast Stations," Federal Communications Commission.
- h This rating is applicable when the duration of the voltage pulse does not exceed 15 per cent of one horizontal scanning cycle. In a 525-line, 30-frame system, 15 per cent of one horizontal scanning cycle is 10 microseconds.



6LC8

AVERAGE PLATE CHARACTERISTICS Triode Unit

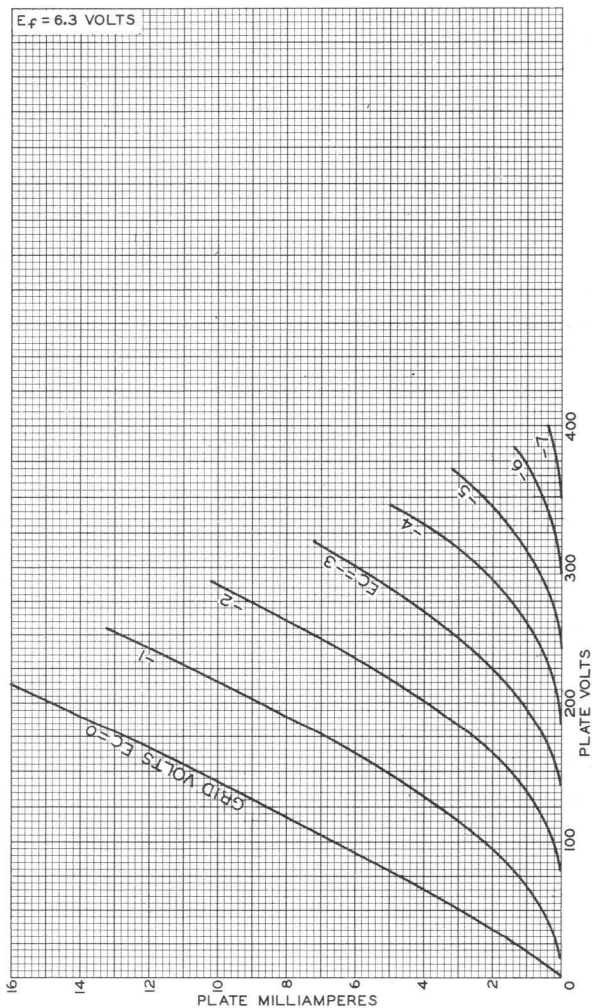

92CM-8644



AVERAGE CHARACTERISTICS Triode Unit

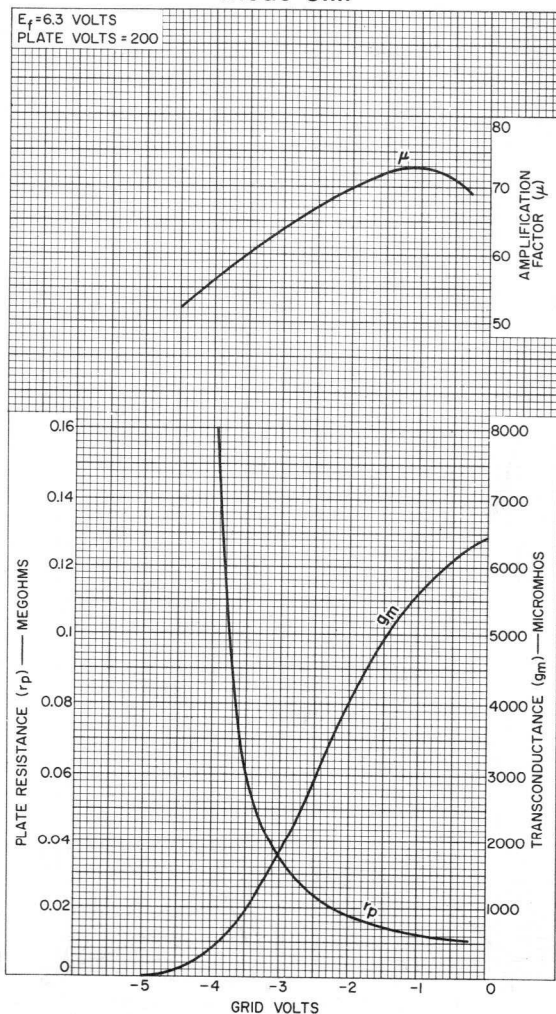

92CM-8647



6LC8

AVERAGE CHARACTERISTICS Pentode Unit

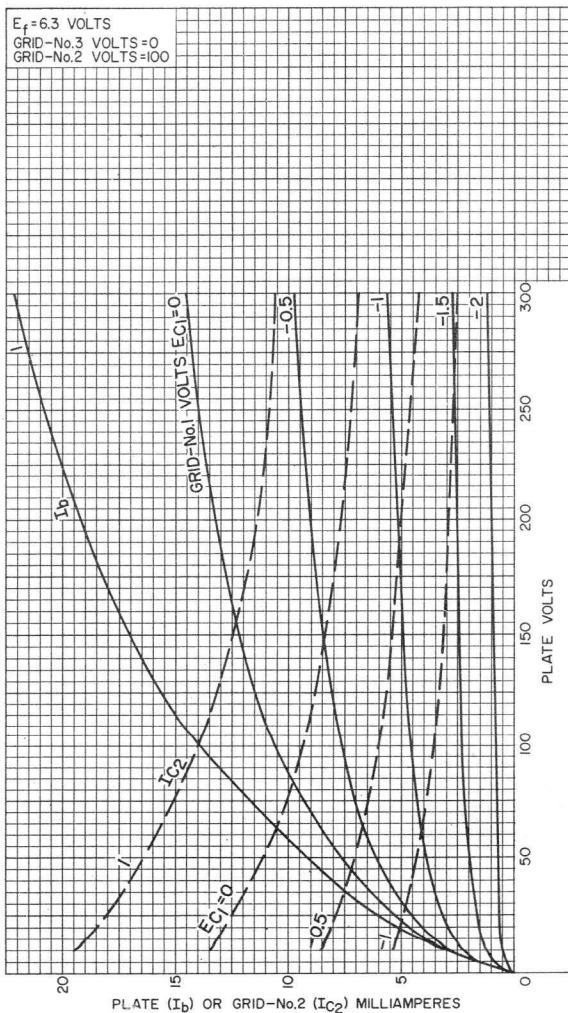

92CM-11594

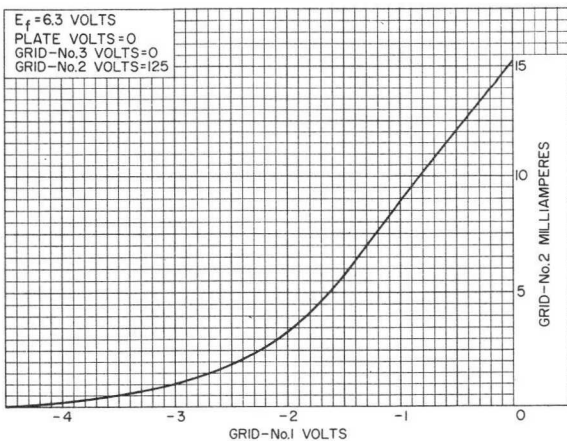

AVERAGE CHARACTERISTICS
Pentode Unit

92CS-11603



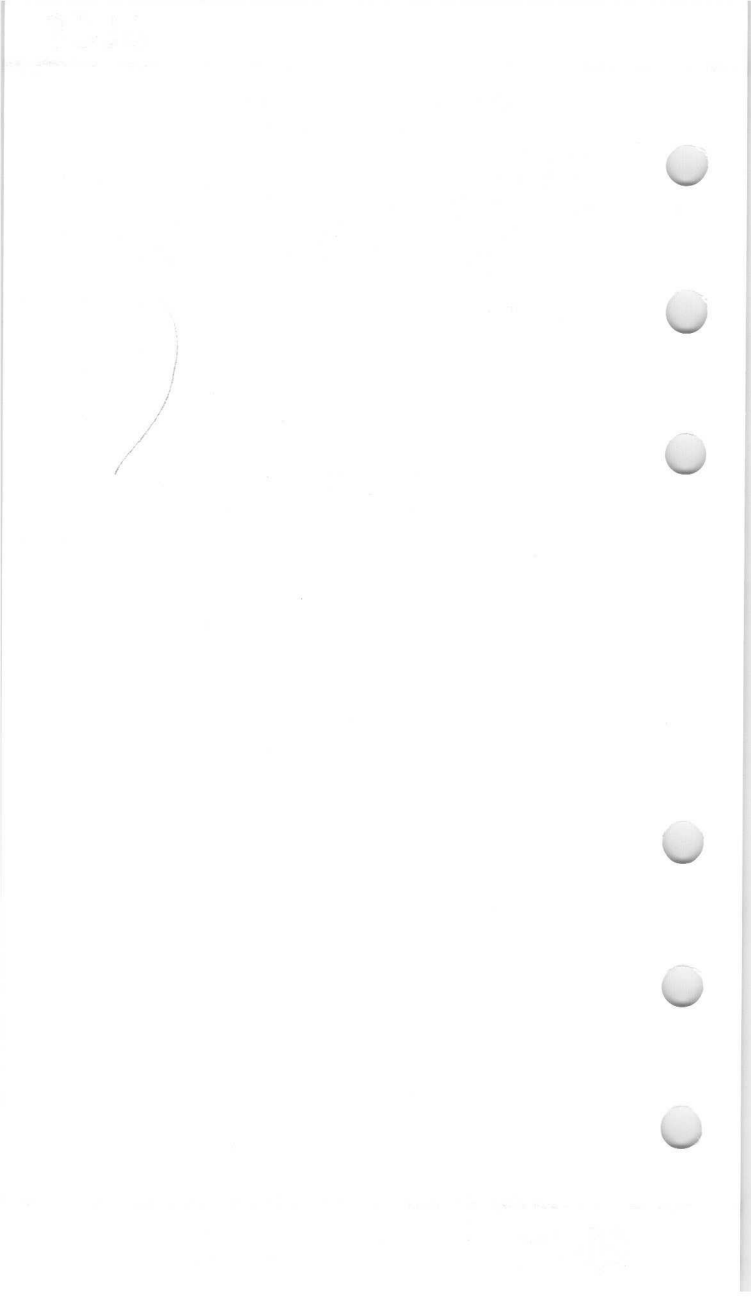

Twin Dual-Control Pentodes

9-PIN MINIATURE TYPE

COMMON-CATHODE, GRID No.1 & GRID No.2

DARK HEATER

*For Combined Color Demodulator and Matrix
Amplifier Applications in Color TV Receivers
Having High-Level Demodulation Systems*

ELECTRICAL CHARACTERISTICS

Bogey Values

Heater Voltage, AC or DC	E_f	6.3	V
Heater Current	I_f	760	mA
Direct Interelectrode Capacitances			
Without external shield			
G3 to P (each unit, with other unit connected to ground)	C_{g3-p}	2.7	pF
G1 to (K, Pp2, Pp1, G3p2, G3p1, G2, H). G3p1 to (K, Pp2, Pp1, G3p2, G2, G1, H)} .	C_{g1-all}	15.5	pF
G3p2 to (K, Pp2, Pp1, G3p1, G2, G1, H)} .	C_{g3-all}	6.0	pF
Pp1 to (K, Pp2, G3p2, G3p1, G2, G1, H)} .	C_{p-all}	3.7	pF
Pp2 to (K, Pp1, G3p2, G3p1, G2, G1, H)} .	C_{p-all}	3.7	pF
G3p1 to G3p2	C_{g3-g3}	0.10	pF

*For the following characteristics, with both units operating,
see Conditions*

Plate Resistance	r_p	50000	Ω
Approx., each unit			
Grid-No.1-to-Plate Transconductance . .	$g_m(g1p)$	5800	μmhos
Each unit			
Grid-No.3-to-Plate Transconductance . .	$g_m(g3p)$	350	μmhos
Each unit			
DC Plate Current	I_b	7.6	mA
Each unit			
DC Grid-No.2 Current ^a	I_{c2}	14.5	mA
Cutoff DC Grid-No.1 Voltage			
Approx., each unit			
For $I_b = 100 \mu\text{A}$	$E_{c1(co)}$	-6.3	V
Cutoff DC Grid-No.3 Voltage ^b			
Approx., each unit			
For $I_b = 100 \mu\text{A}$	$E_{c3(co)}$	-16.5	V

Conditions

Heater Voltage	E_f	6.3	V
DC Plate Voltage	E_b	100	V
Each unit			
DC Grid-No.3 (Control-Grid) Voltage . .	E_{c3}	0	V
Each unit			
DC Grid-No.2 (Screen-Grid) Voltage . .	E_{c2}	100	V
DC Grid-No.1 (Control-Grid) Voltage . .	E_{c1}	-2.5	V



MECHANICAL CHARACTERISTICS

Operating Position Any
 Type of Cathode Coated Unipotential
 Maximum Overall Length 3-1/16 in
 Maximum Seated Length 3-13/16 in
 Length, Base Seat to Bulb Top 2-7/16 ± 3/32 in
 Excluding tip
 Diameter 0.750 to 0.875 in
 Envelope JEDEC T6-1/2
 Dimensional Outline (JEDEC 6-4) See *General Section*
 Base Small-Button Noval 9-Pin (JEDEC E9-1)

TERMINAL DIAGRAM (Bottom View)

- Pin 1 - Plate of Unit No. 2
- Pin 2 - Grid No. 3 of Unit No. 2
- Pin 3 - Cathode
- Pin 4 - Heater
- Pin 5 - Heater
- Pin 6 - Plate of Unit No. 1
- Pin 7 - Grid No. 3 of Unit No. 1
- Pin 8 - Grid No. 2
- Pin 9 - Grid No. 1

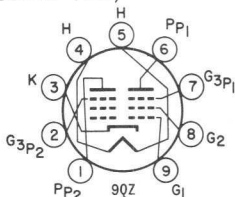

DESIGN MAXIMUM RATINGS

DC Plate Voltage (Each unit)	E_b	300	V
DC Grid-No.2 Voltage	E_{c2}	150	V
Heater-Cathode Voltage			
Peak	e_{hkm}	{ +200 -300	V V
Average ^c	$E_{hk(av)}$	100	V
Heater Voltage, AC or DC	E_f	5.7 to 6.9	V
Grid-No.2 Input	P_{g2}	2	W
Plate Dissipation (Each unit)	P_b	2	W

^a Units in parallel (PP₁ connected to PP₂; G3P₁ connected to G3P₂).

^b For this test, $E_{c1} = -3$ V so that the Grid-No.2 Input rating will not be exceeded.

^c Measured with a dc meter.



Typical Plate Characteristics

Each Unit, with Both Units Operating

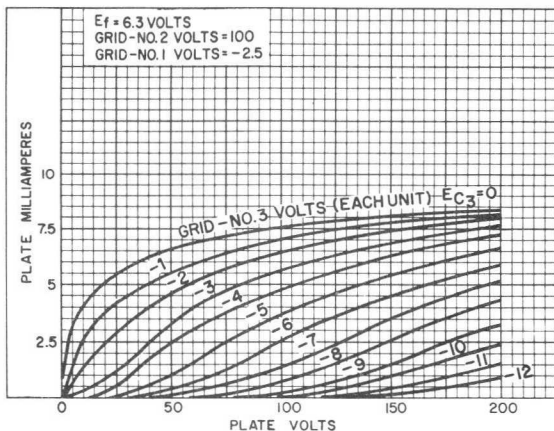

92CS-13459

Typical Plate Characteristics

Each Unit, with Both Units Operating

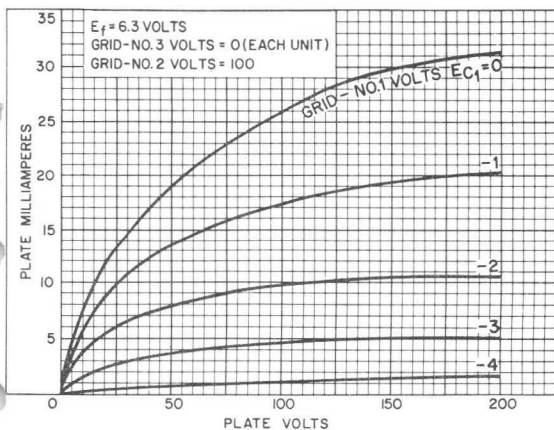

92CS-13460





High-Mu Triode— Sharp-Cutoff Pentode

9-PIN MINIATURE TYPE

For Video-Amplifier Service in Color-TV Receivers and
Other Applications Using Positive Triode-Grid Operation

Electrical:

Heater Characteristics and Ratings:

Voltage (AC or DC)	6.3 ± 0.6 ^a	volts
Current at heater volts = 6.3.	0.600 ^b	amp
Warm-up time (Average)	11	sec
Peak heater-cathode voltage (Each unit):		
Heater negative with respect to cathode	200 max.	volts
Heater positive with respect to cathode	200 ^c max.	volts

Direct Interelectrode Capacitances:^d

Triode Unit:

G _T to P _T	2.2	pf
Input: G _T to (K _T , K _p +G _{3p} +IS, H)	3.2	pf
Output: P _T to (K _T , K _p +G _{3p} +IS, H)	1.8	pf

Pentode Unit:

G _{1p} to P _p	0.060 max.	pf
Input: G _{1p} to (K _p +G _{3p} +IS, G _{2p} , H)	10	pf
Output: P _p to (K _p +G _{3p} +IS, G _{2p} , H)	3.6	pf
G _{1p} to P _T	0.008 max.	pf
P _p to P _T	0.15 max.	pf

Mechanical:

Operating Position.	Any
Type of Cathodes.	Coated Unipotential
Maximum Overall Length.	2-5/8"
Maximum Seated Length	2-3/8"
Length, Base Seat to Bulb Top (Excluding tip)	2" ± 3/32"
Diameter.	0.750" to 0.875"
Dimensional Outline	See <i>General Section</i>
Bulb.	T6-1/2
Base.	Small-Button Noval 9-Pin (JEDEC No. E9-1)
Basing Designation for BOTTOM VIEW.	9DX

- Pin 1—Triode Cathode
- Pin 2—Triode Grid
- Pin 3—Triode Plate
- Pin 4—Heater
- Pin 5—Heater
- Pin 6—Pentode Cathode,
Grid No.3, Internal Shield
- Pin 7—Pentode Grid No.1
- Pin 8—Pentode Grid No.2
- Pin 9—Pentode Plate

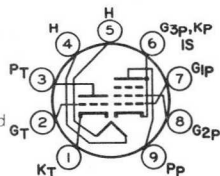

6LF8

Characteristics, Class A Amplifier:

	Triode Unit		Pentode Unit		
Plate Voltage.	200	40	75	100	volts
Grid-No.2 Voltage.	-	-	150	150	volts
Grid-No.1 Voltage.	-2	+3	0	-2.5	volts
Amplification Factor	70	40	-	-	
Plate Resistance (Approx.)	17500	10000	-	200000	ohms
Transconductance	4000	4000	-	11000	μ hos
Plate Current.	4	11	50 ^e	20	ma
Grid-No.2 Current.	-	-	12 ^e	5	ma
Grid-No.1 Current.	0	2.7	0	0	ma
Grid-No.1 Voltage (Approx.) for plate μ a = 20.	-5	-	-	-8	volts

AMPLIFIER — Class A^f

Maximum Ratings, Design-Maximum Values:

	Triode Unit as Class A ₁ or A ₂ Amplifier	Pentode Unit as Class A ₁ Amplifier	
Plate Voltage.	330 max.	330 max.	volts
Grid-No.2 (Screen-Grid) Supply Voltage	-	330 max.	volts
Grid-No.2 Voltage.	-	See Grid-No.2-Input Rating Chart at front of Receiving Tube Section	

Grid-No.1 (Control-Grid)

Voltage:			
Negative-bias value.	55 max.	55 max.	volts
Positive-bias value.	4 max.	0 max.	volts
Grid-No.1 Current.	8 max.	0 max.	ma
Grid-No.2 Input:			
For grid-No.2 voltages up to 165 volts	-	1.1 max.	watts
For grid-No.2 voltages between 165 and 330 volts	-	See Grid-No.2-Input Rating Chart at front of Receiving Tube Section	
Plate Dissipation.	1.1 max.	3.75 max.	watts

Maximum Circuit Values:

	Triode Unit	Pentode Unit	
Grid-No.1-Circuit Resistance:			
For fixed-bias operation	0.5 max.	0.25 max.	megohm
For cathode-bias operation	1 max.	1 max.	megohm

^a For parallel heater operation.

^b For series heater operation current must be limited to 0.600 ± 0.040 amperes.

^c The dc component must not exceed 100 volts.

^d Without external shield.

^e This value can be measured by a method involving a recurrent wave form such that the maximum ratings of the tube will not be exceeded.

^f A Class A Amplifier is an amplifier in which the grid bias and varying grid voltages are such that plate current flows at all times. The subscript 1 added to the class letter denotes that grid current does not flow during any part of the input cycle. The subscript 2 denotes that grid current flows during some part of the cycle.



AVERAGE CHARACTERISTICS Triode Unit

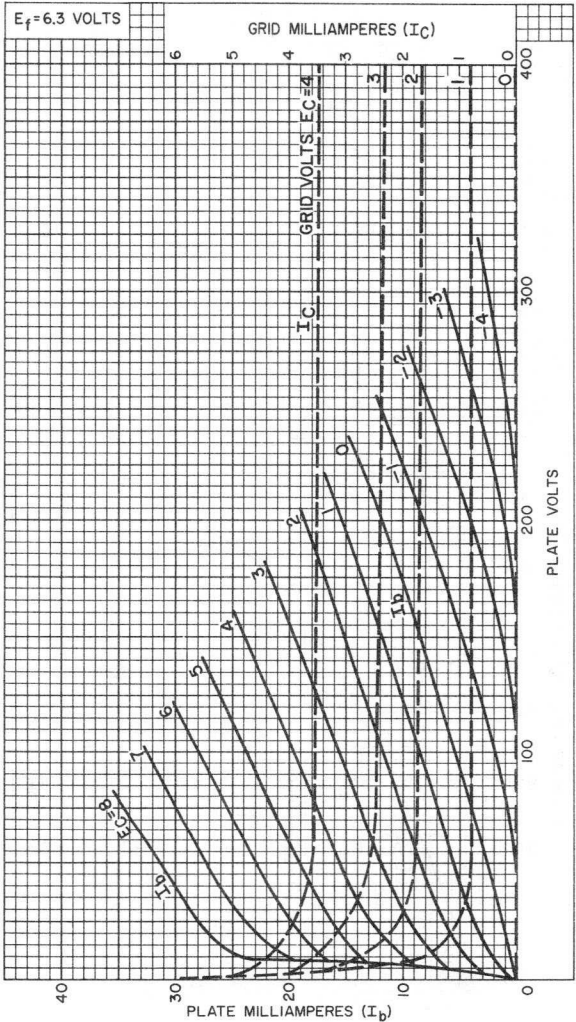

92CM-12384



6LF8

AVERAGE CHARACTERISTICS Triode Unit

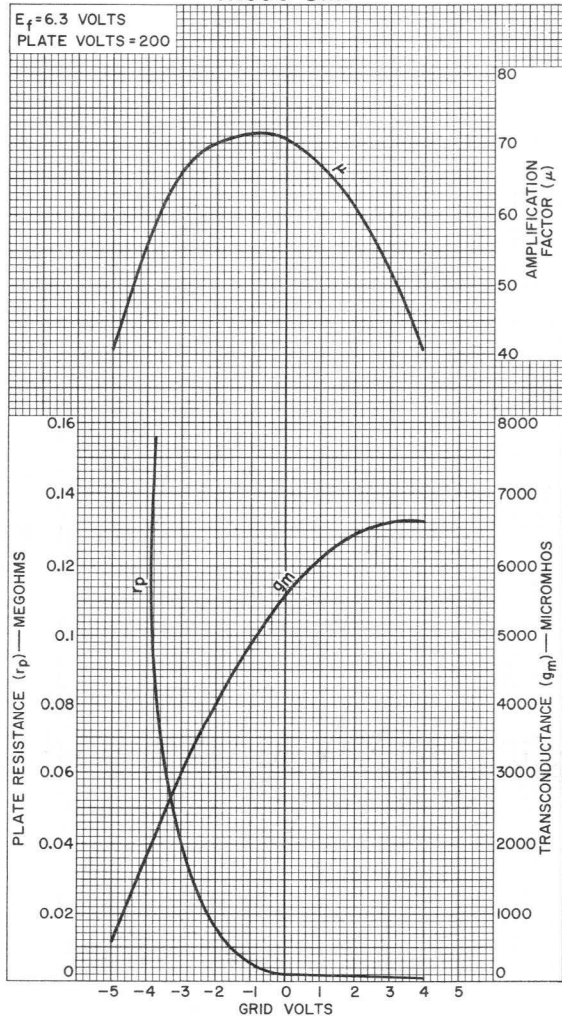

92CM-12388



AVERAGE CHARACTERISTICS

Pentode Unit

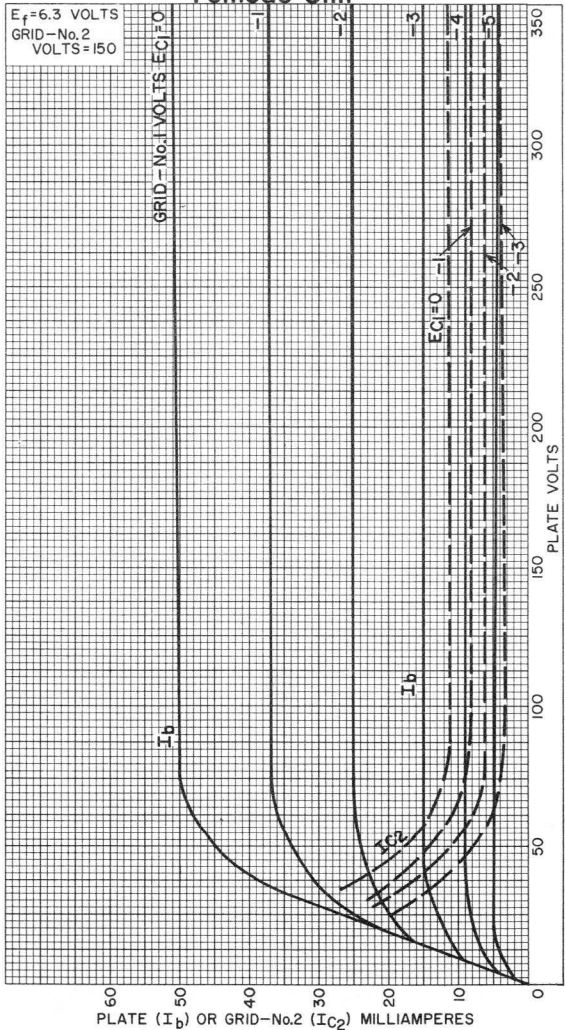

92CM-12398



6LF8

AVERAGE CHARACTERISTICS Pentode Unit

$E_f = 6.3$ VOLTS
PLATE VOLTS = 100
GRID-NO.2 VOLTS = 150

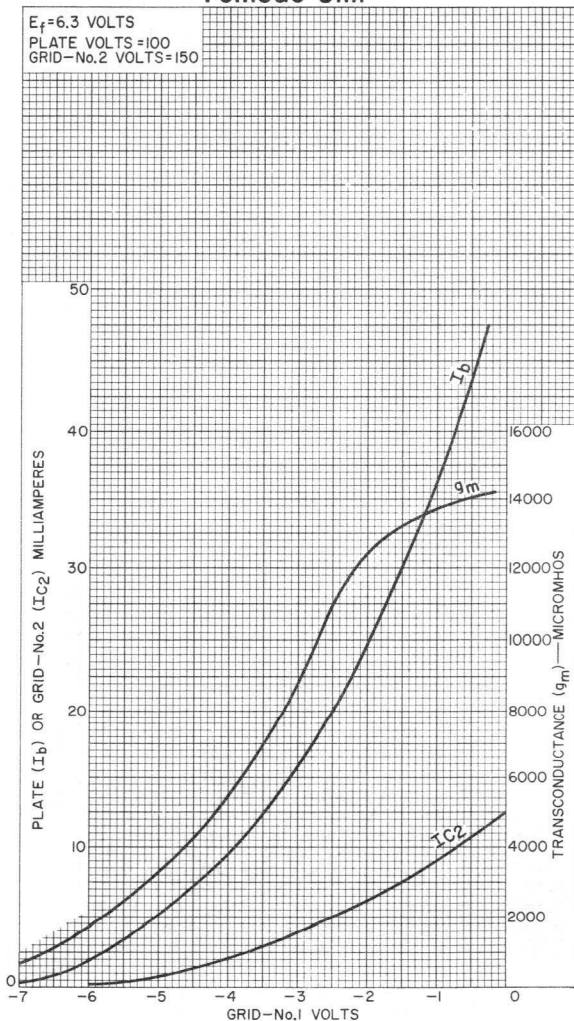

92CM-12403



Medium-Mu Triode— Semiremote-Cutoff Pentode

9-PIN MINIATURE TYPE

SEPARATE CATHODE BASE-PIN CONNECTIONS

For Color and Black-and-White TV Receivers. Pentode Unit is Particularly Suited for Burst-Amplifier Circuit in Color TV. Triode Unit is Useful as a General-Purpose Amplifier.

Electrical:

Heater Characteristics and Ratings:

Voltage (AC or DC)	6.3 ± 0.6	volts
Current at heater volts = 6.3	0.450	amp
Peak heater-cathode voltage (Each unit):		
Heater negative with respect to cathode	200 max.	volts
Heater positive with respect to cathode	200 ^a max.	volts

Direct Interelectrode Capacitances:^b

Triode Unit:

Grid to plate	1.8	pf
Input: G_T to ($K_T, K_P + G_{3P} + IS, H$)	3.2	pf
Output: P_T to ($K_T, K_P + G_{3P} + IS, H$)	1.9	pf

Pentode Unit:

Grid No.1 to plate.	0.015 max.	pf
Input: G_{1P} to ($K_P + G_{3P} + IS, G_{2P}, H$)	5.5	pf
Output: P_P to ($K_P + G_{3P} + IS, G_{2P}, H$)	3.8	pf
Heater to cathode (Each unit)	3.2	pf

Mechanical:

Operating Position.	Any
Type of Cathodes.	Coated Unipotential
Maximum Overall Length.	2-3/16"
Maximum Seated Length	1-15/16"
Length from Base Seat to Bulb Top (Excluding Tip).	1-9/16" ± 3/32"
Diameter.	0.750" to 0.875"
Dimensional Outline	See <i>General Section</i>
Bulb.	T6-1/2
Base.	Small-Button Noval 9-Pin (JEDEC No. E9-1)
Basing Designation for BOTTOM VIEW.	9AE

- Pin 1 - Triode Plate
- Pin 2 - Pentode Grid No.1
- Pin 3 - Pentode Grid No.2
- Pin 4 - Heater
- Pin 5 - Heater
- Pin 6 - Pentode Plate
- Pin 7 - Pentode Cathode,
 Pentode Grid No.3,
 and Internal Shield
- Pin 8 - Triode Cathode
- Pin 9 - Triode Grid

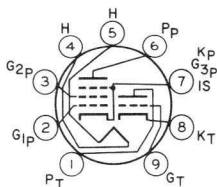

6LM8

AMPLIFIER — Class A₁

	Triode Unit	Pentode Unit	
--	----------------	-----------------	--

Characteristics:

Plate Voltage.	125	125	volts
Grid-No.2 Voltage.	-	125	volts
Grid-No.1 Voltage.	-1	-2	volts
Amplification Factor	46	-	
Plate Resistance (Approx.)	5400	150000	ohms
Transconductance	8500	6000	μmhos
Plate Current.	13.5	12	ma
Grid-No.2 Current.	-	4	ma
Grid-No.1 Voltage (Approx.) for plate $\mu a = 10$	-8	-14	volts

Maximum Ratings, Design-Maximum Values:

Plate Voltage.	330 max.	350 max.	volts
Grid-No.2 (Screen-Grid) Supply Voltage	-	330 max.	volts
Grid-No.2 Voltage.See <i>Grid-No.2 Input Rating Chart</i> at front of Receiving Tube Section		
Grid-No.1 (Control-Grid) Voltage:			
Positive-bias value.	0 max.	0 max.	volts
Grid-No.2 Input:			
For grid-No.2 voltages up to 165 volts.	-	0.55 max.	watt
For grid-No.2 voltages between 165 and 330 volts.See <i>Grid-No.2 Input Rating Chart</i> at front of Receiving Tube Section		
Plate Dissipation.	2.5 max.	2.5 max.	watts

Maximum Circuit Values:

Grid-No.1-Circuit Resistance:			
For fixed-bias operation	0.5 max.	0.25 max.	megohm
For cathode-bias operation	1 max.	0.5 max.	megohm

^a The dc component must not exceed 100 volts.

^b With external shield JEDEC No.315 measured in accordance with EIA Standard RS-191-A.



AVERAGE PLATE CHARACTERISTICS Triode Unit

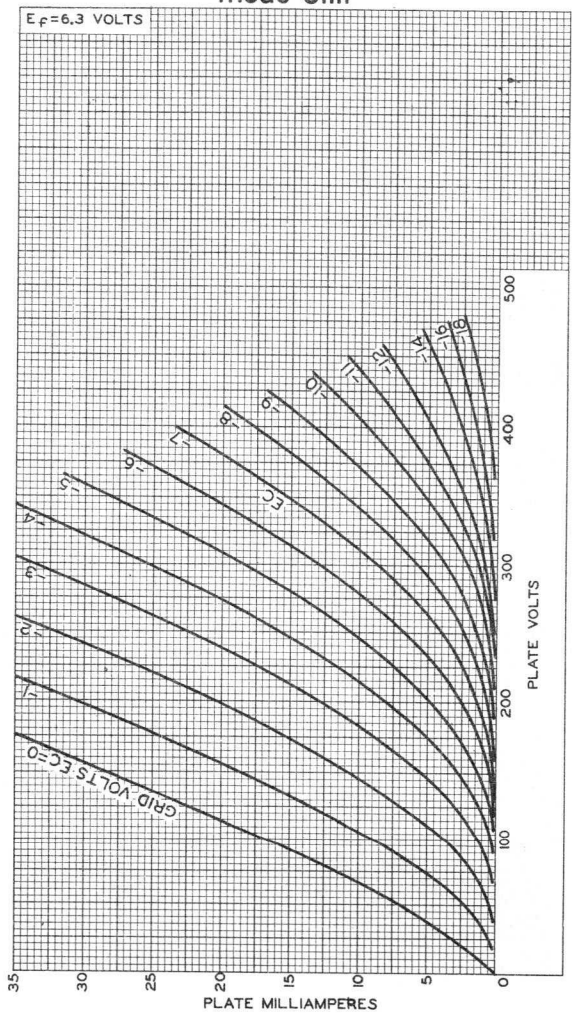

92CM-10421RI



6LM8

AVERAGE CHARACTERISTICS Triode Unit

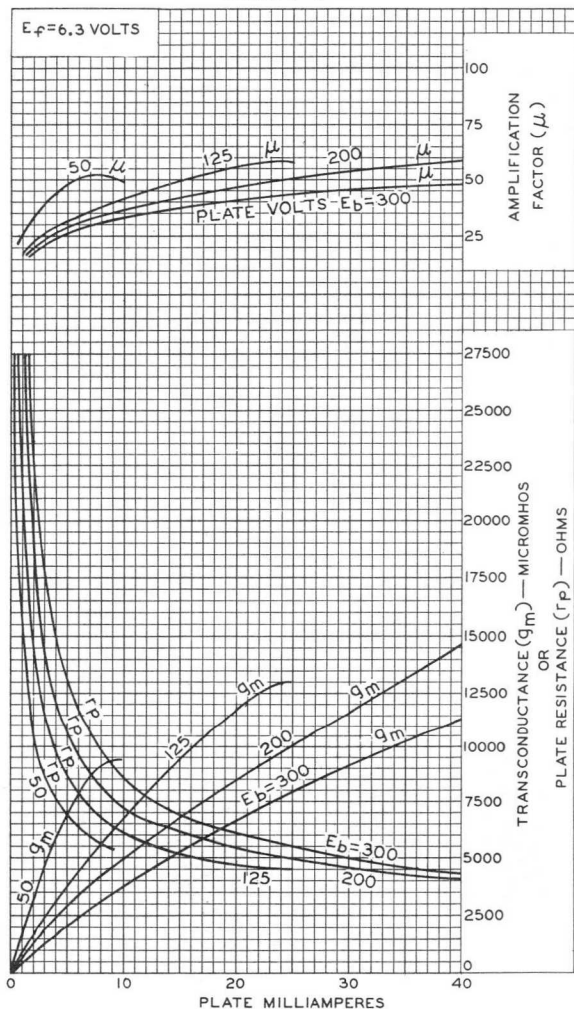

92CM-10428



AVERAGE CHARACTERISTICS

Pentode Unit

 $E_f = 6.3$ VOLTS

GRID-No. 2 VOLTS = 125

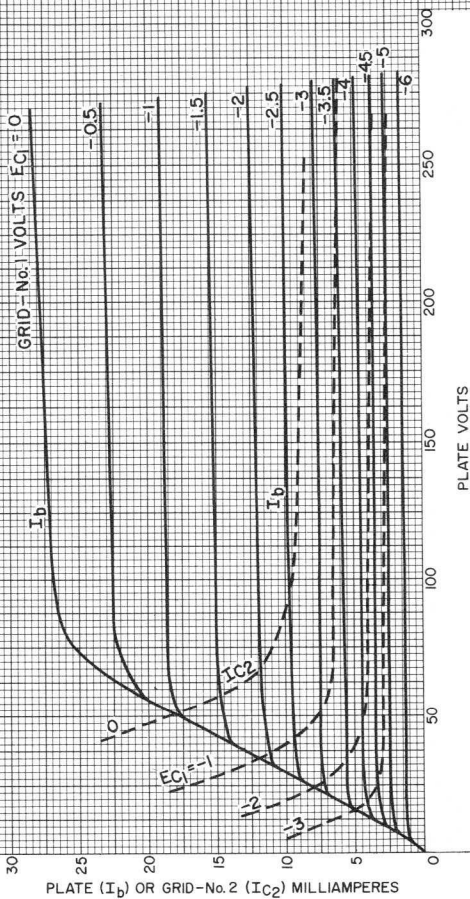

92CM-12560



6LM8

AVERAGE CHARACTERISTICS Pentode Unit

$E_f = 6.3$ VOLTS
PLATE VOLTS = 125
GRID-NO. 2 VOLTS = 125

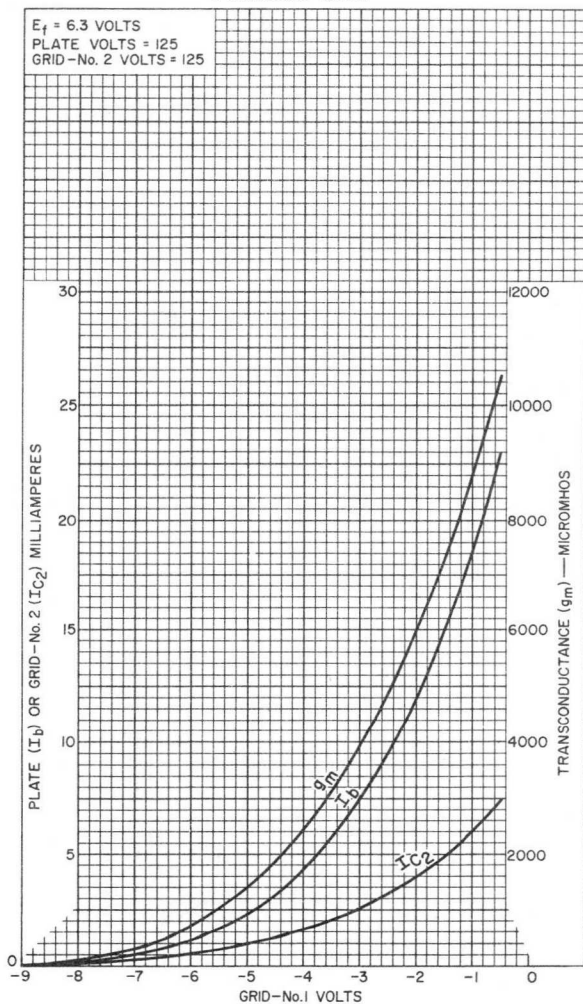

92CM-12558

RADIO CORPORATION OF AMERICA
Electronic Components and Devices
Harrison, N. J.



Beam Power Tube

Pb = 30 W **Novar Type** **Overload Pb = 200 W**
For Color-TV Horizontal-Deflection Amplifier Circuits
Using 270 V to over 400 V "B" Supplies

ELECTRICAL CHARACTERISTICS—Bogey Values

Heater Voltage, ac or dc.	E_h	6.3	V
Heater Current	I_h	2.5	A
Direct Interelectrode Capacitances: ^a			
Grid No.1 to plate.	c_{g1-p}	0.56	pF
Input: G1 to (K,G3,G2,H)	c_i	22	pF
Output: P to (K,G3,G2,H)	c_o	11	pF

For the following characteristics, see Conditions below:

Amplification Factor (Triode Connection) ^b , μ	-	-	3 ^c	-	-	2.8 ^d	
Plate Resistance (Approx.)	r_p	-	5800	-	-	7000 Ω	
Transconductance	g_m	-	9600	-	-	7500 μmho	
DC Plate Current	I_b	-	580 ^e	130	-	710 ^e 95 mA	
DC Grid-No.2 Current	I_{c2}	-	40 ^e	2.8	-	55 ^e 2.4 mA	
Cutoff DC Grid-No.1 Voltage for $I_b = 1 \text{ mA}$	$E_{c1(\text{co})}$	-120	-	-54	-125	-	-60 V

Conditions:

Heater Voltage	E_h	← 6.3 →				V		
Peak Positive-Pulse Plate Voltage ^f	e_{bm}	5000	-	-	5000	-	-	V
DC Plate Voltage	E_b	-	55	175	-	60	175	V
DC Grid-No.3 Voltage	E_{c3}	30	30	30	30	30	30	V
DC Grid-No.2 Voltage	E_{c2}	125	125	125	145	145	145	V
DC Grid-No.1 Voltage	E_{c1}	-	0	-25	-	0	-35	V

MECHANICAL CHARACTERISTICS

Dimensional Outline	JEDEC No.12-117
Envelope.	JEDEC Designation T12
Top Cap ^g	Small (JEDEC Designation C1-1)
Base ^h	Large-Button Novar 9-Pin with Exhaust Tip (JEDEC Designation E9-88)

6LQ6

Terminal Connections

(See *TERMINAL DIAGRAM*) JEDEC Designation 9QL
 Type of Cathode Coated Unipotential

MAXIMUM RATINGS—Design-Maximum Values^k

For operation as a Horizontal-Deflection-Amplifier Tube in a 525-line, 30-frame system

DC Plate Supply Voltage	E_{bb}	990	V
Peak Positive-Pulse Plate Voltage ^m	e_{bm}	7500	V
Peak Negative-Pulse Plate Voltage	$-e_{bm}$	1100	V
DC Grid-No.3 Voltage ⁿ	E_{c3}	75	V
DC Grid-No.2 (Screen-Grid) Voltage	E_{c2}	220	V
Peak Negative-Pulse Grid-No.1 (Control-Grid) Voltage	$-e_{clm}$	330	V
Heater-Cathode Voltage:			
Peak	e_{hkm}	±200	V
Average	E_{hk}	100	V
Heater Voltage, ac or dc	E_h	5.7 to 6.9	V
Cathode Current:			
Peak	i_{km}	1200	mA
Average	$I_{k(av)}$	350	mA
Grid-No.2 Input.	P_{g2}	5	W
Plate Dissipation ^p	P_b	30	W
Temporary Overload Plate Dissipation ^q	P_b	200	W
Envelope Temperature (at hottest point on envelope surface).	T_E	250	°C

MAXIMUM CIRCUIT VALUES

Grid-No.1-Circuit Resistance:	$R_{g1(ckt)}$		
For grid-No.1-resistor-bias operation	-	0.47	MΩ
For plate-pulsed operation (horizontal- deflection circuits only).	-	10	MΩ

TERMINAL DIAGRAM (Bottom View)

- Pin 1 - Grid No.2
- Pin 2 - Grid No.1
- Pin 3 - Cathode
- Pin 4 - Heater
- Pin 5 - Heater
- Pin 6 - Grid No.1
- Pin 7 - Grid No.2
- Pin 8 - Grid No.3
- Pin 9 - Do Not Use
- Top Cap - Plate

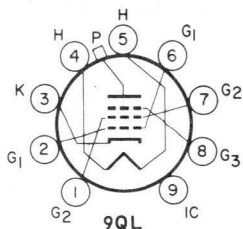

TYPICAL CHARACTERISTICS

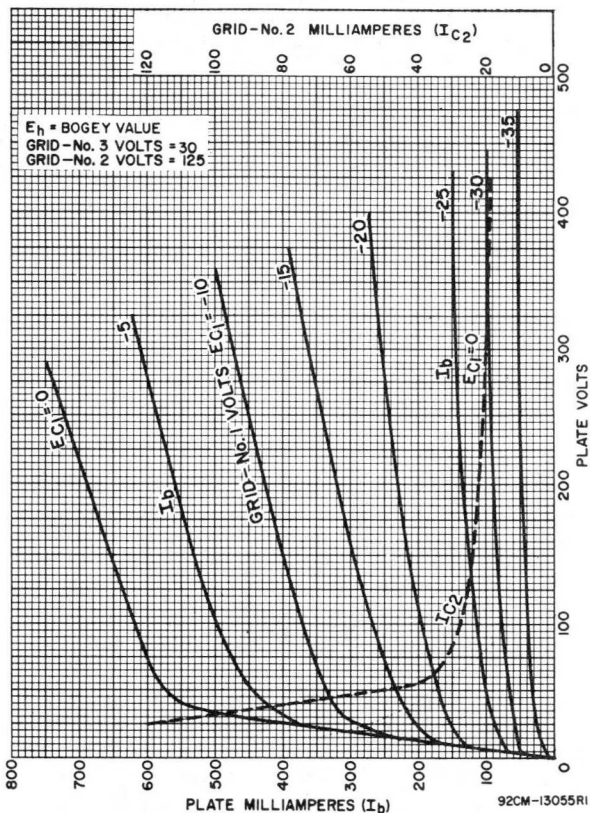

- a Measured without external shield in accordance with the current issue of EIA Standard RS-191.
- b With grid No.3 and grid No.2 connected, respectively, to cathode and plate at socket.
- c Conditions: $E_b = E_{C2} = 125 \text{ V}$, $E_{C1} = -25 \text{ V}$.
- d Conditions: $E_b = E_{C2} = 145 \text{ V}$, $E_{C1} = -35 \text{ V}$.
- e This value can be measured by a method involving a recurrent waveform such that the Maximum Ratings of the tube will not be exceeded.
- f Under pulse-duration condition specified in Footnote m.

6LQ6

- g Designed to mate with connector of 0.360-inch cap, generally available from your local RCA Distributor.
- h Designed to mate with "Novar 9-Contact" Socket generally available from your local RCA Distributor.
- k As defined in the current issue of EIA Standard RS-239.
- m This rating is applicable when the duration of the voltage pulse does not exceed 15% of one horizontal scanning cycle. In a 525-line, 30-frame system, 15% of one scanning cycle is 10 μ s.
- n In horizontal-deflection-amplifier service, a positive voltage should be applied to grid No.3 to reduce interference from "snivets", which may occur in both vhf and uhf television receivers, and to increase power output. A typical value is 30 V.
- p An adequate bias resistor or other means is required to protect the tube in the absence of excitation.
- q Total continuous or accumulated time not to exceed 40 seconds.

TYPICAL CHARACTERISTICS

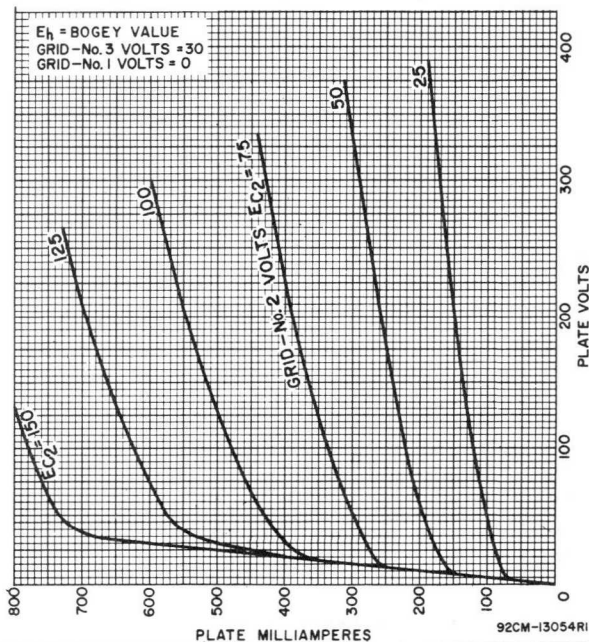

Medium-Mu Triode— Sharp-Cutoff Pentode

9-PIN MINIATURE TYPE

For Use in Low-B+ Black-and-White TV Receivers
Having Low-Voltage Power Supplies

ELECTRICAL CHARACTERISTICS

Bogey Values^a

Heater Voltage (AC or DC)	E _h	6.3	V
Heater Current.	I _h	0.775	A
Direct Interelectrode Capacitances			
Without external shield			
<i>Triode Unit:</i>			
Grid to plate	C _{g-p}	2.8	pF
Input: G _T to (K _T , K _p +G _{3p} +I _S , H)	c _i	4.2	pF
Output: P _T to (K _T , K _p +G _{3p} +I _S , H).	c _o	2.4	pF
<i>Pentode Unit:</i>			
Grid No.1 to plate.	C _{g1-p}	0.12 max	pF
Input: G _{1p} to (K _p +G _{3p} +I _S , G _{2p} , H).	c _i	14	pF
Output: P _p to (K _p +G _{3p} +I _S , G _{2p} , H).	c _o	4.8	pF
Triode grid to pentode plate.	-	0.015 max	pF
Pentode plate to triode plate	-	0.17 max	pF

For the following characteristics, see Conditions

		Triode Unit	Pentode Unit		
Amplification Factor.	μ	46	-	-	
Plate Resistance (Approx.).	r _p	4400	55000	75000	Ω
Transconductance.	g _m	10400	21000	23000	μmho
DC Plate Current.	I _b	15	16.5	20	mA
DC Grid-No.2 Current.	I _{c2}	-	3.1	3.5	mA
Cutoff DC Grid-No.1 Voltage	E _{c1} (c _o)	-6	-4.2	-4.2	V
Plate $\mu\text{A} = 100$					

Conditions

		Bogey value			
Heater Voltage.	E _h				V
DC Plate Supply Voltage	E _{bb}	125	125	200	V
DC Grid-No.2 Supply Voltage	E _{cc2}	-	125	125	V
Grid No.1	-	Connected to negative end of R _k			
Cathode Resistor.	R _k	68	82	68	Ω

MECHANICAL CHARACTERISTICS

Operating Position.	Any
Type of Cathodes.	Coated Unipotential
Maximum Overall Length.	2.625 in
Maximum Seated Length	2.375 in
Maximum Diameter.	0.875 in
Dimensional Outline	See <i>General Section</i>
Envelope.	JEDEC T6-1/2
Base.	Small-Button Noval 9-Pin (JEDEC E9-1)



TERMINAL DIAGRAM (Bottom View)

- Pin 1 - Triode Cathode
- Pin 2 - Triode Grid
- Pin 3 - Triode Plate
- Pin 4 - Heater
- Pin 5 - Heater
- Pin 6 - Pentode Grid No. 3,
Pentode Cathode,
Internal Shield
- Pin 7 - Pentode Grid No. 1
- Pin 8 - Pentode Grid No. 2
- Pin 9 - Pentode Plate

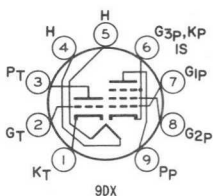

DESIGN-MAXIMUM RATINGS

For operation as a Class A₁ Amplifier Tube

		Triode Unit	Pentode Unit	
DC Plate Voltage	E _b	300	300	V
DC Grid-No.2 (Screen-Grid) Supply Voltage	E _{cc2}	-	300	V
DC Grid-No.2 Voltage	E _{c2}	-	See Grid-No.2	

Input Rating Chart

at front of Receiving Tube Section

DC Grid-No.1 (Control-Grid) Voltage				
Positive-bias value	E _{c1}	0	0	V
Heater-Cathode Voltage				
Peak	e _{hkm}	±200		V
Average ^b	E _{hk(av)}	100		V
Heater Voltage (AC or DC)	E _h	5.7 to 6.9		V
Grid-No.2 Input	P _{g2}			
For E _{c2} ≤ 150 V	-	-	1	W
For E _{c2} ≥ 150 V and ≤ 300 V	-	-	See Grid-No.2	

Input Rating Chart

at front of Receiving Tube Section

Plate Dissipation	P _b	2	5	W
-----------------------------	----------------	---	---	---

MAXIMUM CIRCUIT VALUES

		Triode Unit	Pentode Unit	
Grid-No.1 Circuit Resistance	R _{g1(ckt)}			
For fixed-bias operation.	-	0.5	0.1	MΩ
For cathode-bias operation.	-	1	0.25	MΩ

^a Unless otherwise specified.

^b Measured with a dc meter.



Typical Characteristics

Triode Unit

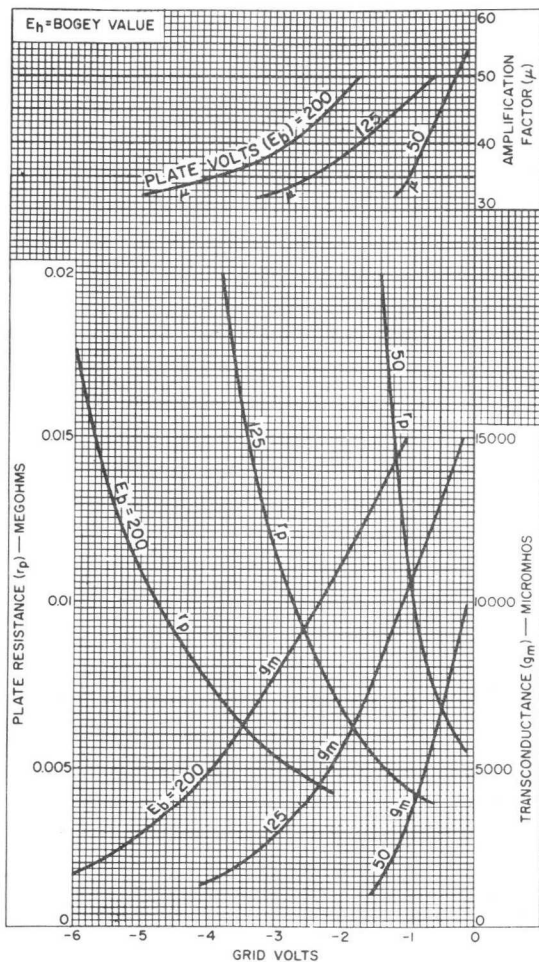

92CM-12623RI



Typical Plate Characteristics

Triode Unit

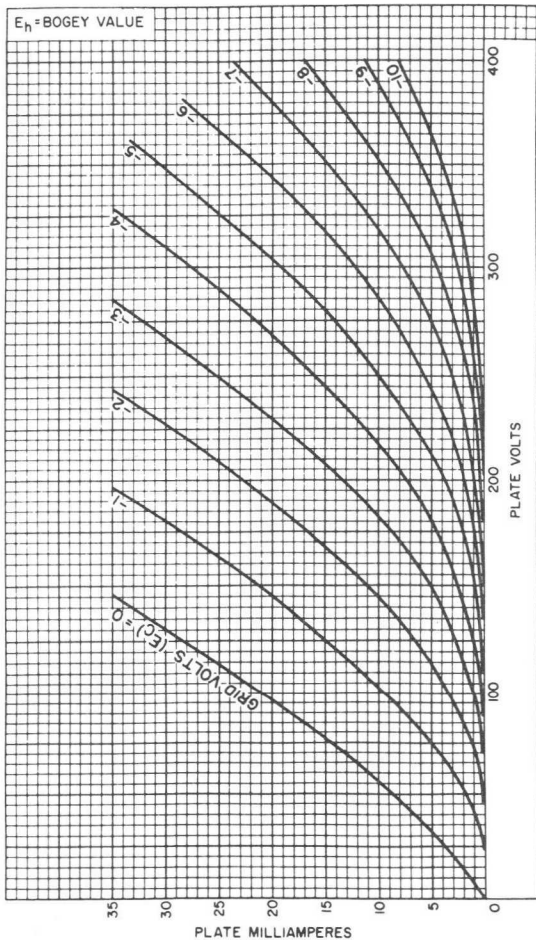

92CM-12616R1



Typical Characteristics

Pentode Unit

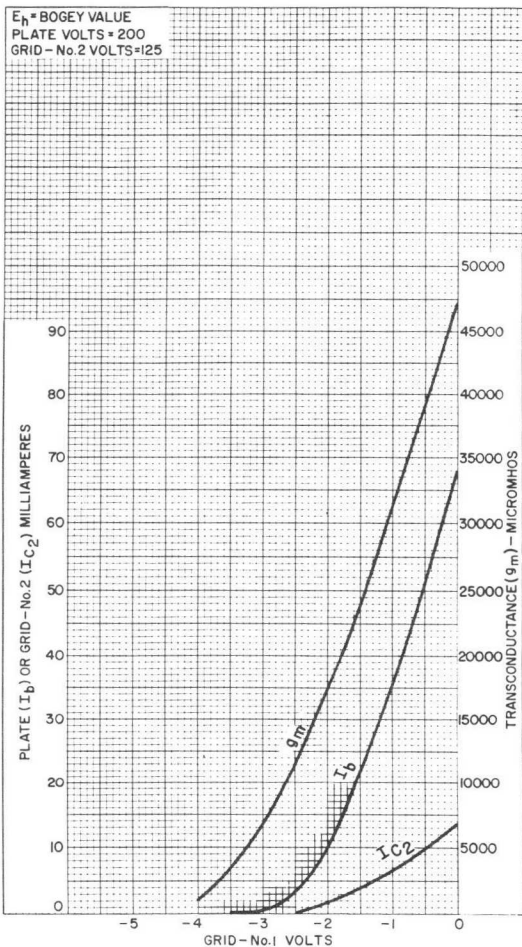

92CM-13750



6LQ8

Typical Plate Characteristics

Pentode Unit

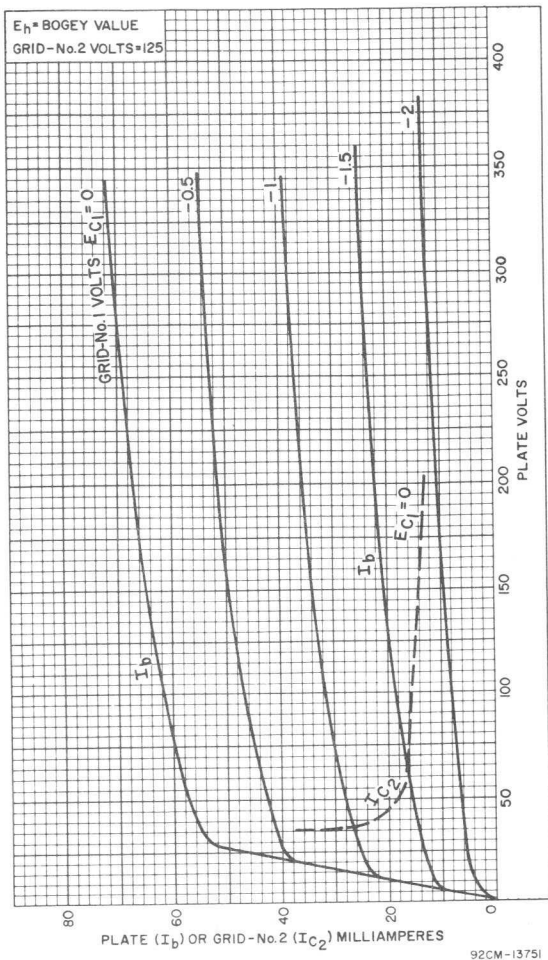

Beam Power Tube

T12 Novar Type

High Perveance Beam Power Tube

For Horizontal-Deflection Amplifier

Service in Low B+ Color-TV Receivers

■ Plate Dissipation = 33 W ■ RCA Dark Heater

■ Peak Cathode Current = 1400 mA

ELECTRICAL CHARACTERISTICS – Bogey Values

Heater Voltage, ac or dc	E_h	6.3	V
Heater Current	I_h	2.85	A
Direct Interelectrode Capacitances: ^a			
Grid No. 1 to plate	c_{g1-p}	1.0	pF
Input: G1 to (K, G3, G2, H) . .	c_i	40	pF
Output: P to (K, G3, G2, H) . .	c_o	16	pF

For the following characteristics, see Conditions below:

Amplification Factor

(Triode Connection)^b . . . μ — — — 4^c

Plate Resistance

(Approx.) r_p — — — 6000 Ω

Transconductance g_m — — — 14000 μmho

DC Plate Current I_b — 1100^d 750^d 125 mA

DC Grid-No. 2 Current . . . I_{c2} — 110^d 42^d 3.3 mA

Cutoff DC Grid-No. 1

Voltage for $I_b = 1 \text{ mA}$. . $E_{c1(\text{co})}$ -125 — 0 -40 V

Conditions:

Heater Voltage E_h ← Bogey Value → V

Peak Positive-Pulse

Plate Voltage^e e_{bm} 5000 — — — V

DC Plate Voltage E_b — 45 60 175 V

DC Grid-No. 3 Voltage . . E_{c3} 30 30 30 0 V

DC Grid-No. 2 Voltage . . E_{c2} 110 160 110 110 V

DC Grid-No. 1 Voltage . . E_{c1} — 0 0 -21 V

MECHANICAL CHARACTERISTICS

Envelope JEDEC T-12

Top Cap Small (JEDEC C1-1)

Base Large-Button Novar 9-Pin with Exhaust Tip
(JEDEC E9-88)

Terminal Connections

(See *TERMINAL DIAGRAM*) JEDEC 9QL

Type of Cathode Coated Unipotential

Operating Position Any

6MC6

MAXIMUM RATINGS — Design-Maximum Values ^f

For operation as a Horizontal-Deflection-Amplifier Tube in a 525-line, 30-frame system.

DC Plate Supply Voltage	E_{bb}	990	V
Peak Positive-Pulse Plate Voltage ^g	e_{bm}	7000	V
Peak Negative-Pulse Plate Voltage	$-e_{bm}$	1100	V
DC Grid-No. 3 Voltage ^h	E_{c3}	75	V
DC Grid-No. 2 (Screen-Grid) Voltage	E_{c2}	250	V
Peak Negative-Pulse Grid-No. 1 (Control-Grid) Voltage	$-e_{clm}$	330	V
Heater-Cathode Voltage:			
Peak	e_{hkm}	±200	V
Average	E_{hk}	100	V
Heater Voltage: 6MC6	E_h	5.7 to 6.9	V
Heater Current: 36MC6	I_h	0.42 to 0.48	A
Cathode Current:			
Peak	i_{km}	1400	mA
Average	$i_{k(av)}$	400	mA
Grid-No. 2 Input	P_{g2}	5	W
Plate Dissipation ^j	P_b	33	W
Envelope Temperature (at hottest point on envelope surface)	T_E	250	°C

MAXIMUM CIRCUIT VALUES

Grid-No. 1 Circuit Resistance:	$R_{g(ckt)}$	
Cathode bias		1.0 megohm (with min. $R_K = 100 \Omega$)
Grid-resistor bias		10.0 megohms (with signal peak clamped to zero bias)
Fixed bias		0.47 megohm (where positive grid current is not drawn)

TERMINAL DIAGRAM — JEDEC 9QL (Bottom View)

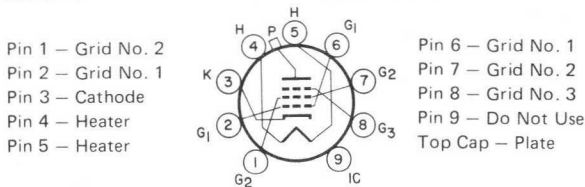

- ^a Measured without external shield in accordance with the current issue of EIA Standard RS-191B.
- ^b With grid No. 3 and grid No. 2 connected, respectively, to cathode and plate at socket.

TYPICAL CHARACTERISTICS

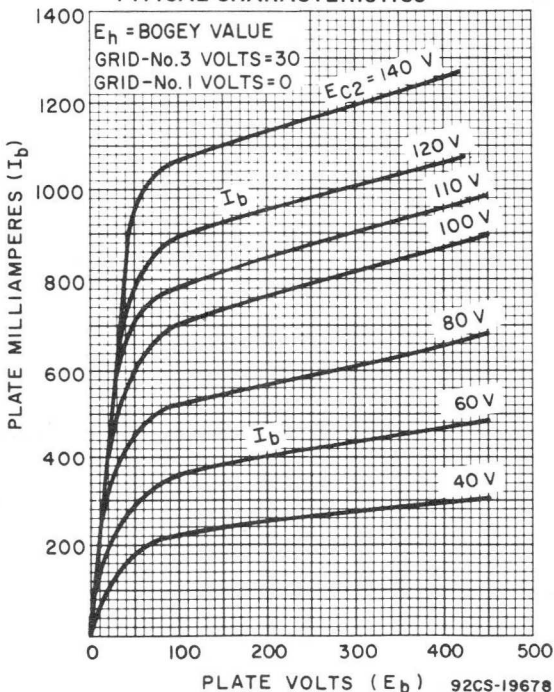

- c Conditions: $E_b = E_{c2} = 175 \text{ V}$, $E_{c1} = -21 \text{ V}$.
- d This value can be measured by a method involving a recurrent waveform such that the Maximum Ratings of the tube will not be exceeded.
- e Under pulse-duration condition specified in *Footnote g*.
- f As defined in the current issue of EIA Standard RS-239A.
- g This rating is applicable when the duration of the voltage pulse does not exceed 15% of one horizontal scanning cycle. In a 525-line, 30-frame system, 15% of one scanning cycle is $10 \mu\text{s}$.
- h In horizontal-deflection-amplifier service, a positive voltage should be applied to grid No. 3 to reduce interference from "snivets", which may occur in both vhf and uhf television receivers, and to increase power output. A typical value is 30 V.
- i An adequate bias resistor or other means is required to protect the tube in the absence of excitation.

6MC6

DIMENSIONAL
OUTLINE
JEDEC No. 12-117

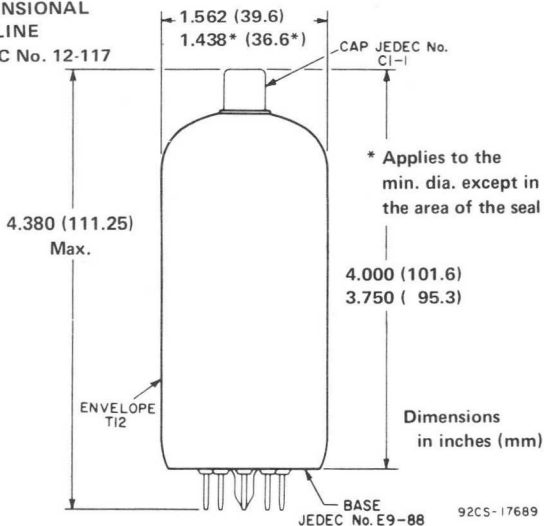

TYPICAL PLATE CHARACTERISTICS

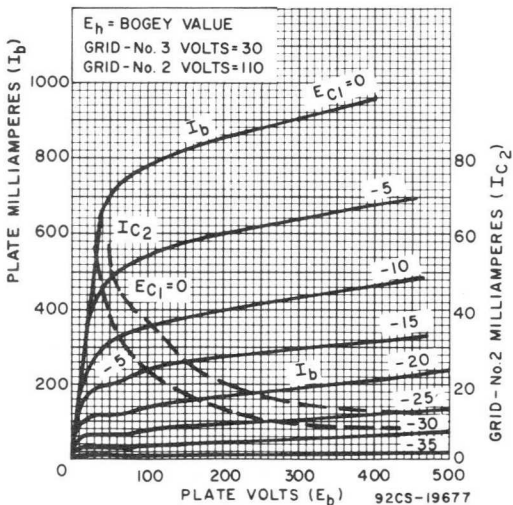

Medium-Mu Triple Triode

NOVAR TYPE

For Matrix-Amplifier Applications in Color-TV Receivers

ELECTRICAL

Heater Characteristics and Ratings

Voltage (AC or DC)	6.3 ± 0.6	V
Current at 6.3 V	0.900	A
Maximum heater-cathode voltage (Each unit):		
Heater negative with respect to cathode:		
Peak	200	V
Heater positive with respect to cathode:		
Peak	200	V
DC Component	100	V

Direct Interelectrode Capacitances (Approx.)^a

	Unit No. 1	Unit No. 2	Unit No. 3	
Grid to plate	3.0	3.0	3.0	pF
Input: G to (K, H)	3.6	3.6	3.4	pF
Output: P to (K, H)	0.48	0.48	0.36	pF

MECHANICAL

Operating Position	Any
Type of Cathode	Coated Unipotential
Maximum Overall Length	2.960 in
Maximum Seated Length	2.580 in
Length, Base Seat to Bulb Top (Excluding tip)	2.060 to 2.240 in
Diameter	1.062 to 1.188 in
Bulb	T9

Bases (Alternates)

Small-Button Novar 9-Pin (JEDEC No. E9-75)

Small-Button Novar 9-Pin with Exhaust Tip 9-Pin (JEDEC No. E9-89)

Basing Designation for BOTTOM VIEW 9RQ

- Pin 1 - Plate of Unit No. 3
- Pin 2 - Plate of Unit No. 2
- Pin 3 - Plate of Unit No. 1
- Pin 4 - Heater
- Pin 5 - Heater
- Pin 6 - Grid of Unit No. 1
- Pin 7 - Cathode
- Pin 8 - Grid of Unit No. 2
- Pin 9 - Grid of Unit No. 3

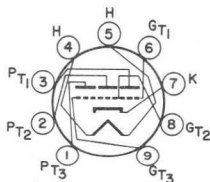
CHARACTERISTICS, CLASS A₁ AMPLIFIER

Values are for Each Unit

Plate Voltage	250	V
Grid Voltage	-10.5	V
Amplification Factor	17	
Plate Resistance (Approx.)	5500	Ω
Transconductance	3100	μmho



6MD8

Plate Current.	11.5	mA
Plate Current for grid volts = -14	4	mA
Grid Voltage (Approx.) for plate $\mu A = 50$	-23	V

AMPLIFIER — CLASS A₁

Values are for Each Unit

Maximum Ratings, Design-Maximum Values

Plate Voltage.	330	V
Grid Voltage		
Positive-bias value.	0	V
Plate Dissipation.	3	W

MAXIMUM CIRCUIT VALUE

Grid-Circuit Resistance		
For fixed-bias operation	1	M Ω

^a Without external shield.

DIMENSIONAL OUTLINE

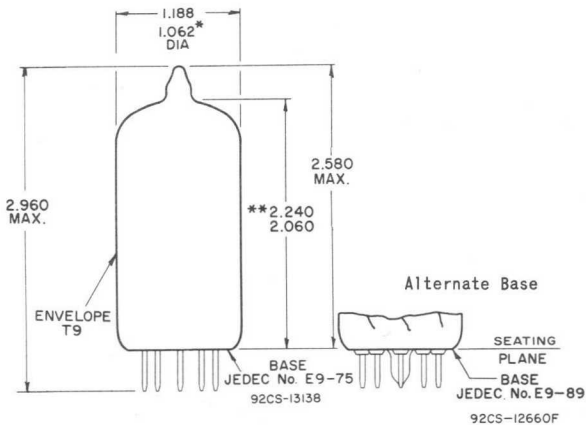

DIMENSIONS IN INCHES

Bottom-exhaust version has the same dimensions for maximum overall length and seated length as the top-exhaust outline shown.

* Applies to the minimum diameter except in the area of the seal.

** Measured from the base seat to bulb-top line as determined by arcing gauge of 0.600" I.D.



Average Plate Characteristics

EACH UNIT

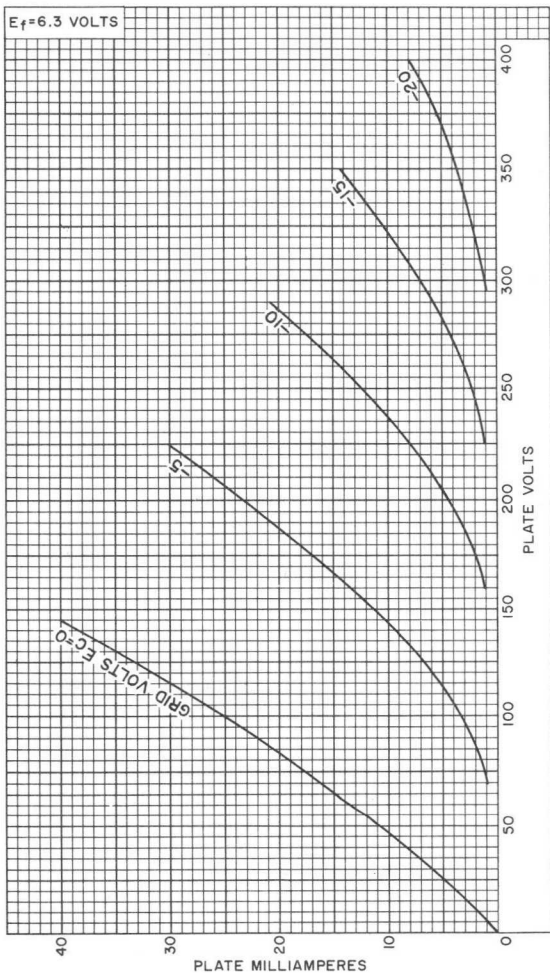

92CM-11966





Beam Power Tube

T12 NOVAR TYPE

$P_b = 30\text{ W}$

Overload $P_b = 200\text{ W}$

Electrical Characteristics — Bogey Values

Heater Voltage, ac or dc	E_h	6.3	V
Heater Current	I_h	2.3	A
Direct Interelectrode Capacitances: ^a			
Grid No. 1 to plate	c_{g1-p}	0.6	pF
Input: G1 to (K, G3, G2, H) . .	c_i	22	pF
Output: P to (K, G3, G2, H) . .	c_o	11	pF

For the following characteristics, see Conditions below:

Amplification Factor

(Triode Connection) ^b . . μ	—	—	3.5 ^c	
Plate Resistance (Approx.). r_p	—	—	5800	Ω
Transconductance gm	—	—	9600	μmho
DC Plate Current I_b	—	580 ^d	130	mA
DC Grid-No. 2 Current . . I_{c2}	—	40 ^d	2.8	mA
Cutoff DC Grid-No. 1				
Voltage for $I_b = 1\text{ mA}$. . $E_{c1}(co)$	-125	—	-44	V

Conditions:

Heater Voltage E_h	← 6.3 →			V
Peak Positive-Pulse				
Plate Voltage ^e e_{bm}	5000	—	—	V
DC Plate Voltage E_b	—	55	175	V
DC Grid-No. 3 Voltage . . E_{c3}	0	30	30	V
DC Grid-No. 2 Voltage . . E_{c2}	125	125	125	V
DC Grid No. 1 Voltage . . E_{c1}		0	-25	V

Mechanical Characteristics

Dimensional Outline	JEDEC No. 12-117
Envelope	JEDEC T-12
Top Cap	Small (JEDEC C1-1)
Base	Large-Button Novar 9-Pin with Exhaust Tip (JEDEC E9-88)

Terminal Connections

(See <i>TERMINAL DIAGRAM</i>)	JEDEC 9QL
Type of Cathode	Coated Unipotential
Operating Position	Any

Maximum Ratings — Design-Maximum Values^f

For operation as a Horizontal-Deflection-Amplifier Tube in a 525-line, 30-frame system.

DC Plate Supply Voltage E_{bb}	990	V
Peak Positive-Pulse Plate Voltage ^g . . . e_{bm}	7500	V
Peak-Negative-Pulse Plate Voltage . . . $-e_{bm}$	1100	V

6ME6

DC Grid-No. 3 Voltage ^h	E _{c3}	75	V
DC Grid-No. 2 (Screen-Grid) Voltage ..	E _{c2}	220	V
Peak Negative-Pulse Grid-No. 1 (Control-Grid) Voltage	-e _{c1m}	330	V
Heater-Cathode Voltage:			
Peak	eh _{km}	±200	V
Average	E _{hk}	100	V
Heater Voltage	E _h	5.7 to 6.9	V
Cathode Current:			
Peak	i _{km}	1200	mA
Average	I _{k(av)}	350	mA
Grid-No. 2 Input	P _{g2}	5	W
Plate Dissipation ^j	P _b	30	W
Temporary Overload Plate Dissipation ^k :	P _b	200	W
Envelope Temperature (at hottest point on envelope surface)	T _E	250	°C

Maximum Circuit Values

Grid-No. 1-Circuit Resistance:	R _{g(ckt)}		
Cathode Bias		1.0	megohm
(with min. R _K = 100 Ω)			
Grid-leak Bias		10.0	megohms
(with signal peak clamped to zero bias)			
Fixed Bias		0.47	megohm
(where positive grid current is not drawn)			

a Measured without external shield in accordance with the current issue of EIA Standard RS-191B.

b With grid No. 3 and grid No. 2 connected, respectively, to cathode and plate at socket.

c Conditions: E_b = E_{c2} = 125 V, E_{c1} = -25 V.

This value can be measured by a method involving a recurrent waveform such that the Maximum Ratings of the tube will not be exceeded.

e Under pulse-duration condition specified in *Footnote g*.

f As defined in the current issue of EIA Standard RS-239A.

g This rating is applicable when the duration of the voltage pulse does not exceed 15% of one horizontal scanning cycle. In a 525-line, 30-frame system, 15% of one scanning cycle is 10 μs.

h In horizontal-deflection-amplifier service, a positive voltage should be applied to grid No. 3 to reduce interference from "snivets", which may occur in both vhf and uhf television receivers, and to increase power output. A typical value is 30 V.

j An adequate bias resistor or other means is required to protect the tube in the absence of excitation.

k Total continuous or accumulated time not to exceed 40 seconds.

TERMINAL DIAGRAM (BOTTOM VIEW)

- Pin 1 - Grid No. 2
- Pin 2 - Grid No. 1
- Pin 3 - Cathode
- Pin 4 - Heater
- Pin 5 - Heater

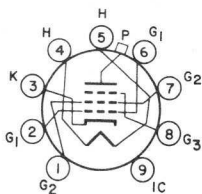

- Pin 6 - Grid No. 1
- Pin 7 - Grid No. 2
- Pin 8 - Grid No. 3
- Pin 9 - Do Not Use
- Top Cap - Plate

TYPICAL CHARACTERISTICS

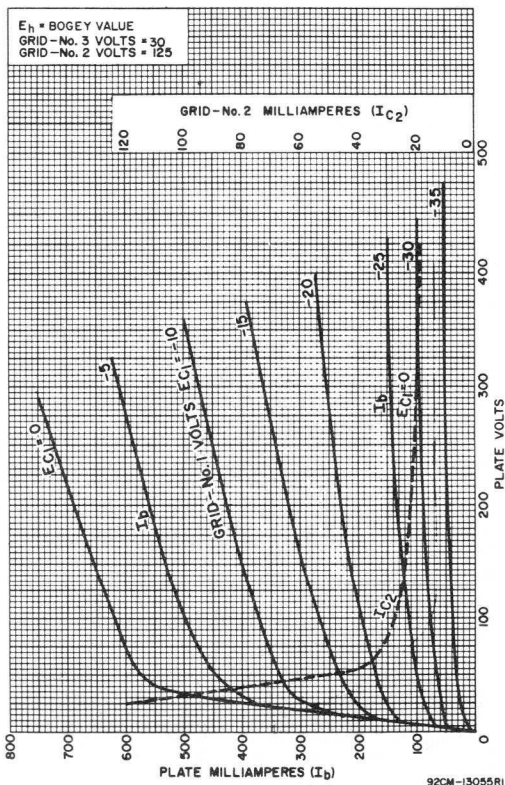

6ME6

DIMENSIONAL OUTLINE

JEDEC No. 12-117

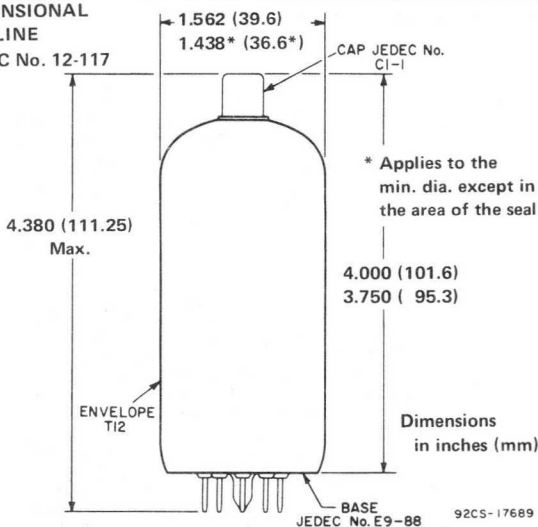

TYPICAL CHARACTERISTICS

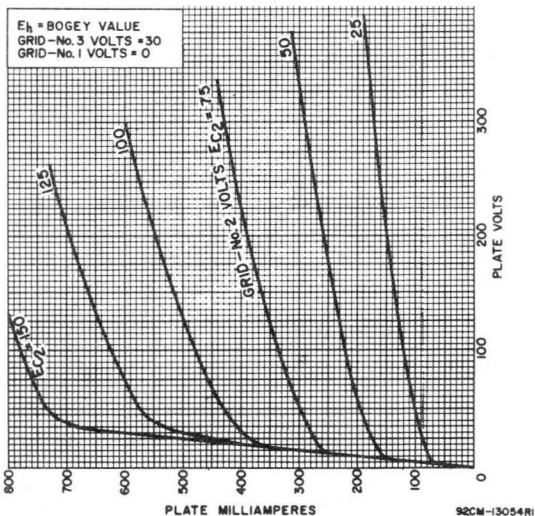

Two-Plate Beam-Deflection Tube

BALANCED OUTPUT 9-PIN MINIATURE TYPE DARK HEATER

*For Color-Demodulator Applications in Color-TV Receivers
and a Variety of Other Switching and Gating Applications*

ELECTRICAL CHARACTERISTICS

Bogey Values^a

Heater Voltage (AC or DC)	E_h	6.3	V
Heater Current at E_h = bogey value	I_h	0.300	A
Direct Interelectrode Capacitances			
Without external shield			
Grid No.1 to all except plates.		7.5	pF
Either plate to all.	C_{p-all}	6.0	pF
Either deflecting electrodes to all other electrodes.	C_{dj-all}	6.0	pF
Plate No.1 to Plate No.2	C_{p1-p2}	0.4	pF
Deflecting-electrode No.1 to deflecting-electrode No.2	$C_{dj1-dj2}$	0.4	pF
Grid No.1 to deflecting- electrode No.1.	C_{g1-dj1}	0.07 max	pF
Grid No.1 to deflecting- electrode No.2.	C_{g1-dj2}	0.1 max	pF

For the following characteristics see Conditions "A"

Transconductance, grid No.1 to both plates	g_m	4400	μ mho
Total DC Plate Current (plate-No.1 + plate-No.2 current)	$I_{b(tot)}$	14.5	mA
DC Grid-No.3 Current	I_{c3}	0.7	mA
Cutoff DC Grid-No.1 Voltage for $I_{b(tot)} = 10 \mu A$	$E_{c1(co)}$	-16	V

Conditions "A"

Heater Voltage	E_h	Bogey Value	V
DC Plate-No.1 Supply Voltage	E_{bb1}	250	V
Plate No.2	-	Connected to plate No.1	
DC Deflecting-Electrode-No.1 Supply Voltage.	-	75	V
DC Deflecting-Electrode-No.2 Supply Voltage.	-	75	V
DC Grid-No.3 Supply Voltage.	E_{cc3}	350	V
DC Grid-No.1 Supply Voltage.	E_{cc1}	0	V
Cathode Resistor	R_k	390	Ω

*For the following deflecting-electrode characteristics,
see Conditions "B"*

Deflecting-Electrode Switching Voltage ^b	$E_{dj}(\text{switching})$	30 max	V
Voltage Difference between Deflecting Electrodes for equal plate currents ($I_{b1} = I_{b2}$)	-	0	V



6ME8

Plate-No.1 Current with deflecting electrode-No.1 voltage (E_{dj1}) = 55 V and deflecting-electrode-No.2 voltage (E_{dj2}) = 95 V	I_{b1}	1.3 max	mA
Plate-No.2 Current with (E_{dj1}) = 95 V and (E_{dj2}) = 55 V	I_{b2}	1.3 max	mA
Deflecting-Electrode-No.1 Current with E_{dj1} = 125 V and E_{dj2} = 25 V	I_{dj1}	0.04 max	mA
Deflecting-Electrode-No.2 Current with E_{dj1} = 25 V and E_{dj2} = 125 V	I_{dj2}	0.04 max	mA

Conditions "B"

Heater Voltage.	E_h	6.3	V
DC Plate-No.1 Supply Voltage.	E_{bb1}	250	V
DC Plate-No.2 Supply Voltage.	E_{bb2}	250	V
DC Grid-No.3 Supply Voltage	E_{cc3}	350	V
DC Grid-No.1 Supply Voltage	E_{cc1}	0	V
Cathode Resistor.	R_k	390	Ω

MECHANICAL CHARACTERISTICS

Operating Position.	Any
Type of Cathode	Coated Unipotential
Maximum Overall Length.	2.625 in
Maximum Seated Length	2.375 in
Length, Base Seat to Bulb Top	
Excluding tip	1.906 to 2.094 in
Maximum Diameter.	0.875 in
Dimensional Outline (JEDEC 6-3)	See <i>General Section</i>
Envelope.	JEDEC T6-1/2
Base.	Small-Button Noval 9-Pin (JEDEC E9-1)

TERMINAL DIAGRAM (Bottom View)

- Pin 1 - Deflecting Electrode No.2
- Pin 2 - Deflecting Electrode No.1
- Pin 3 - Grid No.3
- Pin 4 - Heater End B
- Pin 5 - Heater End A,
Internal Shield[▲]
- Pin 6 - Grid No.1
- Pin 7 - Grid No.2, Cathode
- Pin 8 - Plate No.2
- Pin 9 - Plate No.1

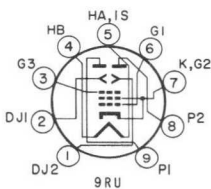

[▲] Pin No.5 should be connected directly to ground.

DESIGN-MAXIMUM RATINGS

DC Plate Voltage, each plate.	E_b	400	V
DC Deflecting-Electrode Voltage, each electrode.	E_{dj}	100	V
Peak Deflecting-Electrode Voltage, each electrode.	$e_{dj\text{m}}$	± 200	V
DC Grid-No.3 (Accelerating-Grid) Voltage	E_{c3}	400	V
DC Grid-No.1 (Control-Grid) Voltage			
Positive-bias value	E_{c1}	0	V
Heater Voltage (AC or DC)	E_h	5.7 to 6.9	V



DESIGN-MAXIMUM RATINGS (Cont'd)

Average Cathode Current.	$I_k(av)$	30	mA
Grid-No.3 Input.	P_{g3}	2	W
Plate Dissipation, each plate.	P_b	2	W

MAXIMUM CIRCUIT VALUES

Grid-No.1-Circuit Resistance	$R_{g1}(ckt)$		
For fixed-bias operation		0.1	MΩ
For cathode-bias operation		0.25	MΩ

^a Unless otherwise specified.

^b Defined as the total voltage change from 75 volts on either deflecting electrode with an equal and opposite change on the other deflecting electrode required to switch the plate current from one plate to the other.

OPERATING CONSIDERATIONS

Magnetic fields adversely affect the intrinsic operating plate-current balance of the 6ME8. To minimize this effect, the tube should be mounted as far as possible from all devices producing extraneous magnetic fields such as transformers, chokes, or similar components. It is recommended that an external shield be used in those applications critical for plate-current balance.



Typical Plate Characteristics

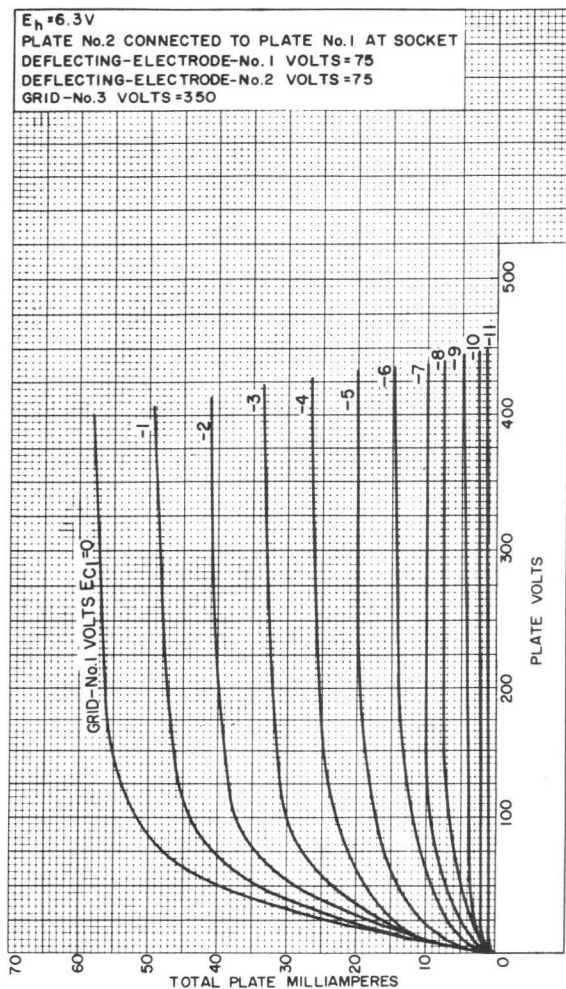

92CM-14470



Transfer Characteristics

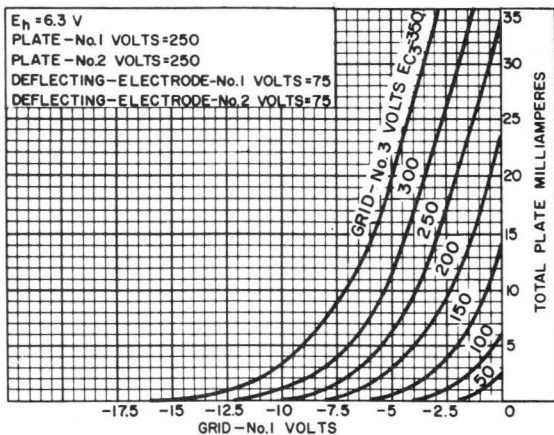

92CS-14468

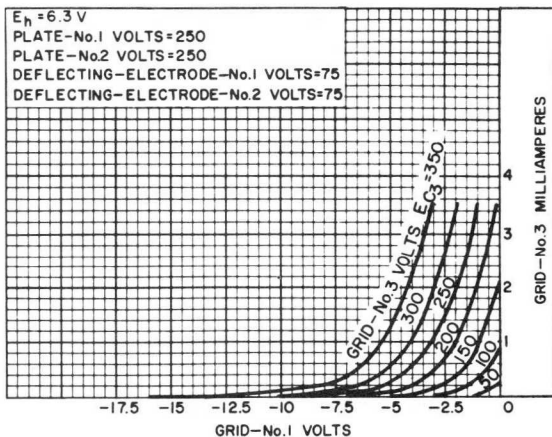

92CS-14469



Transfer Characteristics

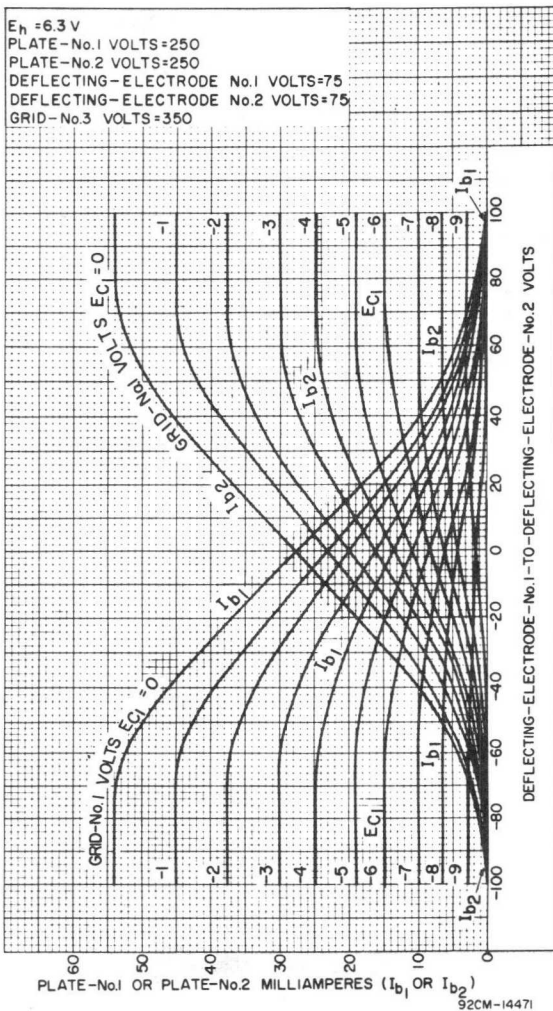

Medium-Mu Triple Triode

For Matrix-Amplifier Applications in Color-TV Receivers

ELECTRICAL CHARACTERISTICS

Heater Voltage (ac or dc)	E_h	6.3		V	
Heater Current	I_h	0.900		A	
Direct Interelectrode Capacitances: ^a		<i>Unit No.1</i>	<i>Unit No.2</i>	<i>Unit No.3</i>	
Grid to plate	C_{gp}	2.8	2.8	2.8	pF
Input: G to (K, H)	C_{in}	2.9	2.9	3.0	pF
Output: P to (K, H)	C_{out}	0.36	0.60	0.70	pF

For the following characteristics, see Conditions below:
Values are for each unit.

Amplification Factor	μ	17		
Plate Resistance (Approx.)	r_p	5600		Ω
Transconductance	G_m	3000		μmho
Plate Current	I_b	10		mA
Plate Current for grid volts = -14		4		mA
Grid Voltage (Approx.) for $I_b = 50\mu\text{A}$		-23		V

Conditions:

Heater Voltage	E_h	6.3		V
Plate Voltage	E_b	250		V
Grid Voltage	E_c	-10.5		V

MECHANICAL CHARACTERISTICS

Maximum Overall Length	2.875 in (73.02 mm)
Maximum Seated Length	2.50 in (63.5 mm)
Maximum Diameter	1.188 in (30.1 mm)
Dimensional Outline	JEDEC E9-60
Envelope	T9
Base	Small-Button Duodecar 12-Pin with Exhaust Tip (JEDEC No.E12-70)
Terminal Diagram	JEDEC 12HG
Type of Cathode	Coated Unipotential
Operating Position	Any

6MJ8

MAXIMUM RATINGS - Design-Maximum Values^b

Values are for Each Unit

Plate Voltage	E_{bb}	330	V
Grid Voltage:			
Positive-bias value	E_{cc}	0	V
Plate Dissipation	P_b	3	W
Heater-cathode voltage (Each unit):			
Peak	e_{hkm}	±200	V
Average ^c	$E_{hk(av)}$	100	V
Heater Voltage, ac or dc	E_h	5.7 to 6.9	V

MAXIMUM CIRCUIT VALUE

Grid-Circuit Resistance:

For fixed-bias operation	R_{g1}	1	$M\Omega$
----------------------------------	----------	---	-----------

^a Measured without external shield in accordance with the current issue of EIA Standard RS-191.

^b As defined in the current issue of EIA Standard RS-239.

^c Measured with a dc meter.

TERMINAL DIAGRAM - Bottom View

- Pin 1 - Heater
- Pin 2 - Plate of Unit No.3
- Pin 3 - Cathode
- Pin 4 - Plate of Unit No.2
- Pin 5 - No Internal Connection
- Pin 6 - Plate of Unit No.1
- Pin 7 - No Internal Connection
- Pin 8 - Grid of Unit No.1
- Pin 9 - No Internal Connection
- Pin 10 - Grid of Unit No.2
- Pin 11 - Grid of Unit No.3
- Pin 12 - Heater

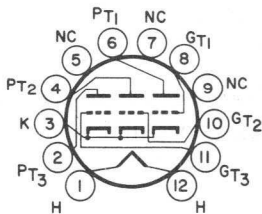

JEDEC 12HG

DIMENSIONAL OUTLINE - JEDEC E9-60

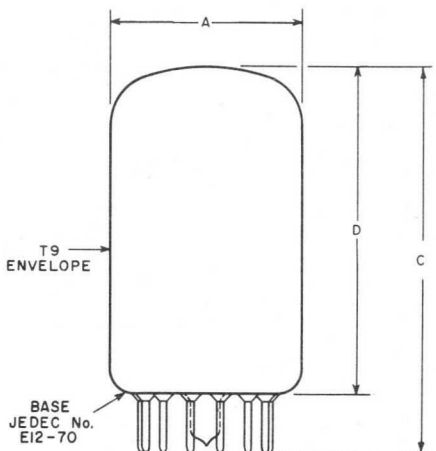

92CS-13200VI

DIMENSION	INCHES		MILLIMETERS	
	Min.	Max.	Min.	Max.
A	1.062*	1.188	27.0*	30.1
C	—	2.875	—	73.02
D	2.250	2.500	57.2	63.5
MILLIMETER DIMENSION DERIVED FROM INCH DIMENSION				
* Applies to the minimum diameter except in the area of the seal.				

6MJ8

AVERAGE PLATE CHARACTERISTICS

Each Unit

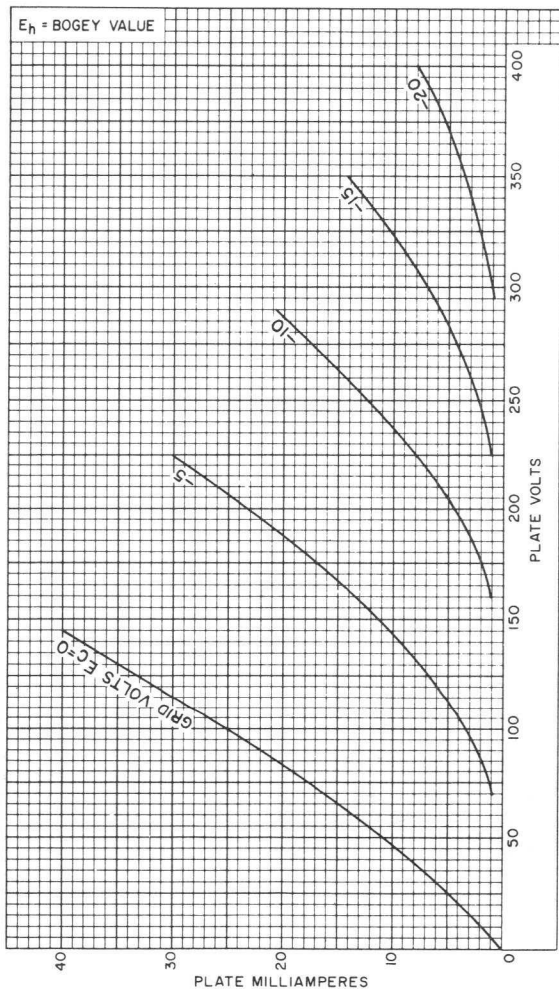

92CM-11966R1

High-Mu Triple Triode

Duoducar Type

For Matrix-Amplifier Applications
in Color-TV Receivers

ELECTRICAL CHARACTERISTICS - Bogy Values

Heater Voltage (ac or dc)	E_h	6.3		V	
Heater Current	I_h	0.9		A	
Direct Interelectrode Capacitances: ^a		<i>Unit</i>	<i>Unit</i>	<i>Unit</i>	
		<i>No.1</i>	<i>No.2</i>	<i>No.3</i>	
Grid to plate	C_{gp}	2.6	2.6	2.6	pF
Input: G to (K, H)	C_{in}	4.6	4.6	4.6	pF
Output: P to (K, H)	C_{out}	0.33	0.57	0.65	pF

For the following characteristics, see Conditions below:
Values are for each unit.

Amplification Factor	μ	47	40	
Plate Resistance (Approx.)	r_p	6250	10,000	Ω
Transconductance	G_m	7500	4000	μmho
Plate Current	I_b	11	4.8	mA
Grid Voltage (Approx.) for $I_b = 50\mu\text{A}$		-5	-11	V

Conditions:

Heater Voltage	E_h	6.3	6.3	V
Plate Voltage	E_b	125	200	V
Grid Voltage	E_c	-1	-4	V

MECHANICAL CHARACTERISTICS

Maximum Overall Length	2.875 in (73.02 mm)
Maximum Seated Length	2.50 in (63.5 mm)
Maximum Diameter	1.188 in (30.1 mm)
Dimensional Outline	JEDEC E9-60
	See Outlines, Glass Tubes in General Section
Envelope	T9
Base	Small-Button Duodecar 12-Pin with Exhaust Tip (JEDEC No.E12-70)
Terminal Diagram	JEDEC 12HU
Type of Cathode	Coated Unipotential
Operating Position	Any

6MN8

MAXIMUM RATINGS - Design-Maximum Values^b

Values are for Each Unit

Plate Voltage	E_{bb}	330	V
Grid Voltage:			
Positive-bias value	E_{cc}	0	V
Plate Dissipation	P_b	3	W
Heater-cathode voltage (Each unit):			
Peak	e_{hkm}	±200	V
Average ^c	$E_{hk(av)}$	100	V
Heater Voltage, ac or dc	E_h	5.7 to 6.9	V

MAXIMUM CIRCUIT VALUE

Grid-Circuit Resistance:

For fixed-bias operation	R_g	1	$M\Omega$
----------------------------------	-------	---	-----------

^a Measured without external shield in accordance with the current issue of EIA Standard RS-191.

^b As defined in the current issue of EIA Standard RS-239.

^c Measured with a dc meter.

TERMINAL DIAGRAM - Bottom View

- Pin 1 - Heater
- Pin 2 - Plate of Unit No.3
- Pin 3 - Cathode
- Pin 4 - Plate of Unit No.2
- Pin 5 - No Internal Connection
- Pin 6 - Plate of Unit No.1
- Pin 7 - Do Not Use
- Pin 8 - Grid of Unit No.1
- Pin 9 - Do Not Use
- Pin 10 - Grid of Unit No.2
- Pin 11 - Grid of Unit No.3
- Pin 12 - Heater

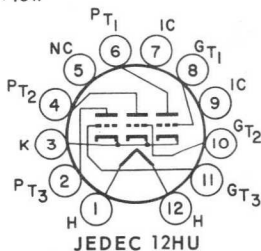

Medium-Mu Triode— Sharp-Cutoff Pentode

9-Pin Miniature Type

For Use as a General-Purpose-Amplifier

Tube in Color- and Black-and-White TV Receivers

ELECTRICAL CHARACTERISTICS — Bogey Values^a

Heater Voltage, ac or dc	E_h	$6.3 \pm 10\%$	V
Heater Current	I_h	535	mA
Direct Interelectrode Capacitances: ^b (Without External Shield)			
<i>Triode Unit:</i>			
Grid to plate	c_{g-p}	1.7	pF
Input: G_T to (K_T , G_{3P} + K_P + IS, H)	c_i	3.0	pF
Output: P_T to (K_T , G_{3P} + K_P + IS, H).	c_o	1.4	pF
<i>Pentode Unit:</i>			
Grid No.1 to plate	c_{g1-p}	0.045	pF
Input: G_{1P} to (K_P + G_{3P} + IS, G_{2P} , H)	c_i	7.5	pF
Output: P_P to (K_P + G_{3P} + IS, G_{2P} , H).	c_o	2.2	pF

For the following characteristics, see Conditions below:

		Triode Unit	Pentode Unit	
Amplification Factor	μ	40	-	
Plate Resistance (Approx.)	r_p	5	150	$k\Omega$
Transconductance	g_m	8500	10000	μmho
DC Plate Current	I_b	18	12	mA
DC Grid-No.2 Current	I_{c2}	-	4.5	mA
Cutoff DC Grid-No.1				

Voltage for $I_b = 20 \mu A$.	$E_{c1(c0)}$	-12	-7	V
--------------------------------	--------------	-----	----	---

Conditions:

Heater Voltage	E_h	6.3	6.3	V
DC Plate Voltage	E_b	150	125	V
DC Grid-No.2 Voltage	E_{c2}	-	125	V
Cathode Resistance	R_k	56	62	Ω

TERMINAL DIAGRAM (Bottom View)

- Pin 1 - Triode Plate
- Pin 2 - Pentode Grid No.1
- Pin 3 - Pentode Grid No.2
- Pin 4 - Heater
- Pin 5 - Heater
- Pin 6 - Pentode Plate
- Pin 7 - Pentode Cathode, Grid No.3 and Internal Shield
- Pin 8 - Triode Cathode
- Pin 9 - Triode Grid

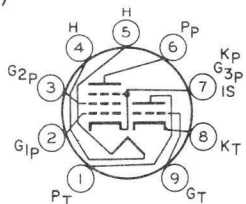

JEDEC 9AE

6MQ8

MECHANICAL CHARACTERISTICS

Maximum Overall Length	2.187 in (55.54 mm)
Maximum Seated Length	1.937 in (49.19 mm)
Maximum Diameter	0.875 in (22.12 mm)
Envelope	JEDEC T6-1/2
Base	Small-Button Noval 9-Pin (JEDEC E9-1)
Dimensional Outline	JEDEC 6-2
Terminal Diagram	JEDEC 9AE
Type of Cathodes	Coated Unipotential
Operating Position	Any

MAXIMUM RATINGS - Design-Maximum Values^c

	<i>Triode Unit</i>	<i>Pentode Unit</i>	
DC Plate Voltage E_b	330	330	V
DC Grid-No.2 Supply Voltage	E_{c2}	330	V
DC Grid-No.2 Voltage	See <i>Grid-No.2 Input Rating Chart</i> at front of Receiving Tube Section.		
DC Grid-No.1 Voltage:			
Positive-bias value E_{c1}	0	0	V
Heater-Cathode Voltage:			
Peak e_{hkm}	±200	±200	V
DC E_{hk}	100	100	V
Heater Current I_h	500 to	570	mA
Grid-No.2 Input: For grid-No.2 voltages up to 165 volts P_{g2}	-	0.55	W
For grid-No.2 voltages between 165 and 330 volts	See <i>Grid-No.2 Input Rating Chart</i> at front of Receiving Tube Section.		
Plate Dissipation P_b	2.7	2.5	W

MAXIMUM CIRCUIT VALUES

Grid-No.1 Circuit Resistance:			
For fixed-bias operation $R_{g1(ckt)}$	0.5	0.25	$M\Omega$
For cathode-bias operation $R_{g1(ckt)}$	0.5	0.5	$M\Omega$

INTERELECTRODE LEAKAGE

Minimum Leakage Resistance between grid No.1 of each unit and all other electrodes of both units tied together	R_{g1-all}	100	$M\Omega$
--	--------------	-----	-----------

Conditions:

E_h = bogey value, E_{c1} = -100 V with respect to all other electrodes tied together.

- a Unless otherwise specified.
- b Measured in accordance with the current issue of EIA Standard RS-191.
- c As defined in the current issue of EIA Standard RS-239.

TYPICAL CHARACTERISTICS - Triode Unit

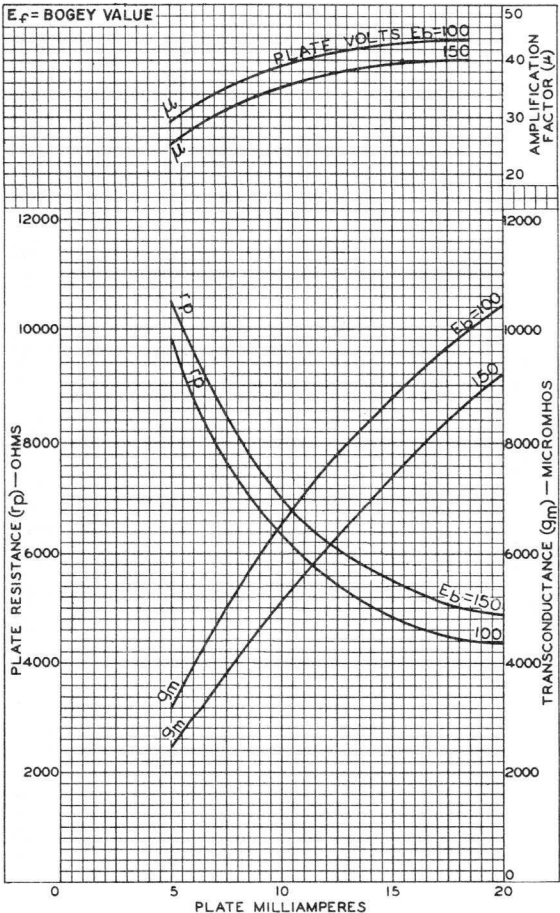

92CM-9882RI

6MQ8

TYPICAL CHARACTERISTICS - Triode Unit

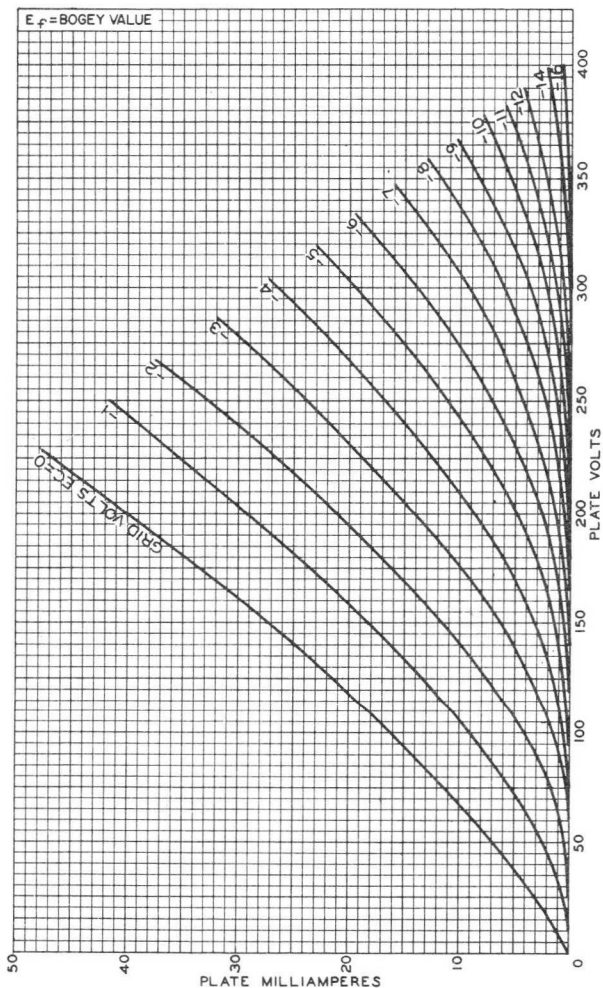

92CM-9866RI

TYPICAL CHARACTERISTICS - Pentode Unit

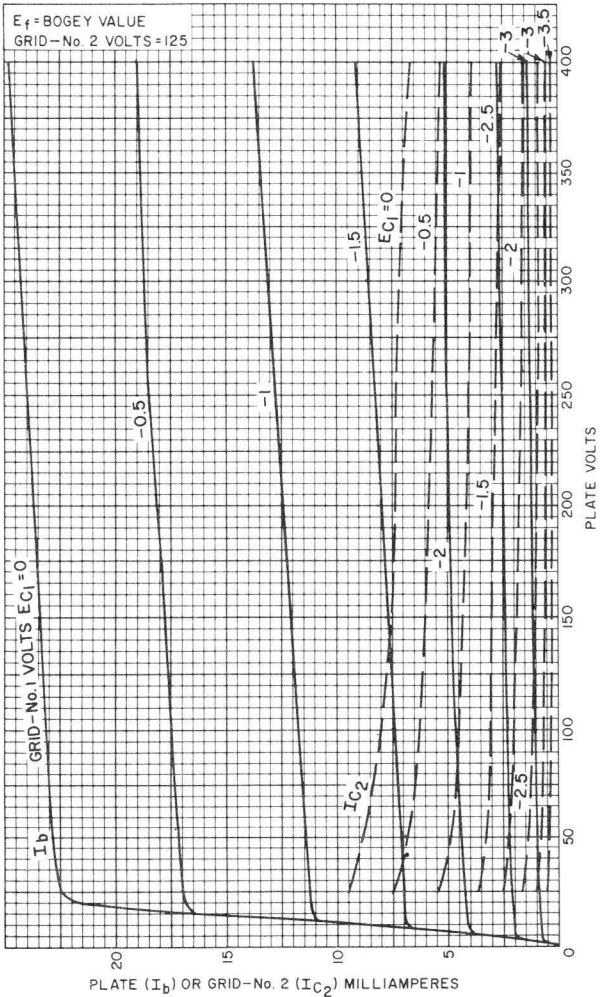

92CM-15102

TYPICAL CHARACTERISTICS - Pentode Unit

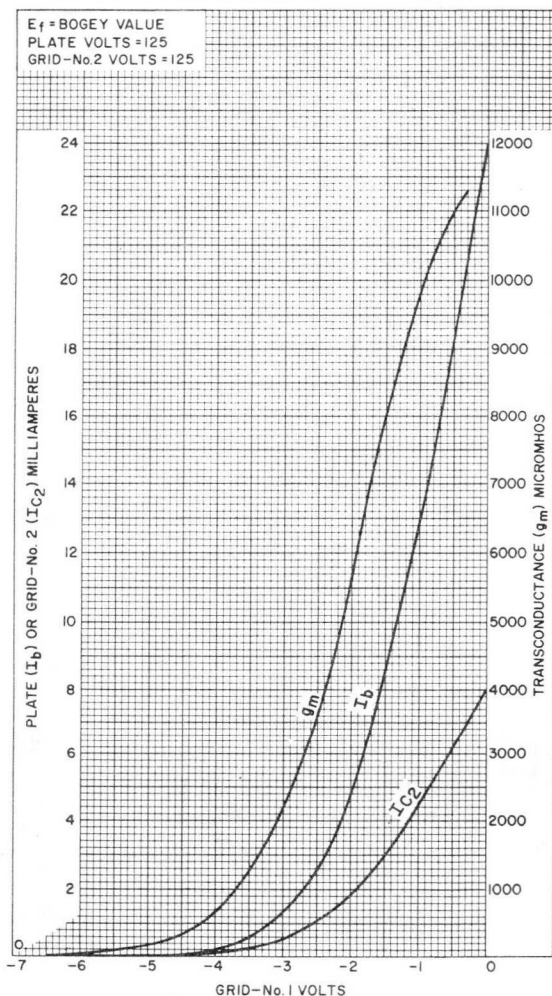

92CM-15107

Medium-Mu Triode— Sharp-Cutoff Pentode

9-Pin Miniature Type

For Use as a Burst Amplifier and General-Purpose-
Amplifier Tube in Color- and Black-and-White TV
Receivers

ELECTRICAL CHARACTERISTICS — Bogey Values ^a

Heater Voltage, ac or dc	E_h	6.3	V
Heater Current	I_h	600	mA
Direct Interelectrode Capacitances: ^b		<i>Without External Shield</i>	<i>With External Shield</i> ^c
<i>Triode Unit:</i>			
Grid to plate	c_{g-p}	2.2	2.2 pF
Input: G_T to (K_T , G_{3p} + K_P + IS, H)	c_i	3.0	3.2 pF
Output: P_T to (K_T , G_{3p} + K_P + IS, H)	c_o	2.2	2.4 pF
Heater to cathode	c_{h-k}	4.4	4.8 ^d pF
<i>Pentode Unit:</i>			
Grid No. 1 to plate	c_{gl-p}	0.05	0.05 pF
Input: G_{1p} to (K_P + G_{3p} + IS, G_{2p} , H)	c_i	9.0	9.0 pF
Output: P_P to (K_P + G_{3p} + IS, G_{2p} , H)	c_o	3.6	4.4 pF
Heater to cathode	c_{h-k}	5.5	7.5 ^d pF
Pentode grid No. 1 to triode plate	P_{gl-Tp}	0.17max.	0.2max. pF
Pentode plate to triode plate	P_p-T_p	0.09max.	0.008max pF
<i>For the following characteristics, see</i>			
Conditions		<i>Triode Unit</i>	<i>Pentode Unit</i>
Amplification Factor	μ	35	-
Plate Resistance (Approx.)	r_p	5.8	165 k Ω
Transconductance	g_m	6000	9000 μ mho
DC Plate Current	I_b	11.5	19 mA
DC Grid-No.2 Current	I_{c2}	-	4.2 mA
Cutoff DC Grid-No.1 Voltage(Approx.):			
For $I_b=10\mu A$	$E_{c1(co)}$	-5.8	- V
For $I_b=20\mu A$	$E_{c1(co)}$	-	-9.5 V

6MU8

Conditions		Triode Unit	Pentode Unit	
Heater Voltage	E_h	6.3	6.3	V
DC Plate Voltage	E_b	125	150	V
DC Grid-No.2 voltage	E_{c2}	-	150	V
DC Grid-No.1 voltage	E_{c1}	-1	-	V
Cathode Resistance	R_k	-	150	Ω

MECHANICAL CHARACTERISTICS

Maximum Overall Length	2.625 in (66.67 mm)
Maximum Seated Length	2.375 in (60.32 mm)
Maximum Diameter (<i>See Dimensional Outline</i>)	0.875 in (22.12 mm)
Envelope	JEDEC T6-1/2
Base	Small-Button Noval 9-Pin(JEDEC E9-1)
Dimensional Outline	JEDEC 6-3
Terminal Diagram	JEDEC 9AE
Type of Cathodes	Coated Unipotential
Operating Position	Any

MAXIMUM RATINGS - Design-Maximum Values

		Triode Unit	Pentode Unit	
DC Plate Voltage	E_b	330	330	V
DC Grid-No.2 Supply Voltage	E_{c2}	-	330	V
DC Grid-No.2 Voltage	<i>See Grid-No.2 Input Rating Chart at front of Receiving Tube Section</i>			
DC Grid-No.1 Voltage:				
Positive-bias value	E_{c1}	0	0	V
Heater-Cathode Voltage:				
Peak	e_{hkm}	± 200	± 200	V
DC	E_{hk}	100	100	V
Heater Voltage, ac or dc	E_h	5.7	to 6.9	V
Grid-No.2 Input: For grid- No.2 voltages up to 165 volts	P_{g2}	-	1.1	W
For grid-No.2 voltages between 165 and 330 volts	<i>See Grid-No.2 Input Rating Chart at front of Receiving Tube Section</i>			
Plate Dissipation	P_b	2.5	3.75	W

MAXIMUM CIRCUIT VALUES

Grid-No.1 Circuit Resistance:				
For fixed-bias operation	R_{g1}	0.5	0.25	$M\Omega$
For cathode-bias operation	R_{g1}	1.0	1.0	$M\Omega$

- a Unless otherwise specified.
- b Measured in accordance with the current issue of EIA Standard RS-191.
- c With external shield JEDEC No. 315 connected to cathode of unit under test except as noted.
- d With external shield JEDEC No. 315 connected to ground.
- e As defined in the current issue of EIA Standard RS-239.

TERMINAL DIAGRAM(Bottom View)

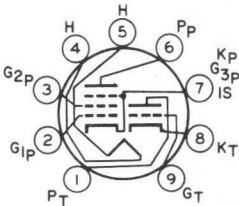

JEDEC 9AE

- Pin 1 - Triode Plate
- Pin 2 - Pentode Grid No.1
- Pin 3 - Pentode Grid No.2
- Pin 4 - Heater
- Pin 5 - Heater
- Pin 6 - Pentode Plate
- Pin 7 - Pentode Cathode,
Grid No.3 and
Internal Shield
- Pin 8 - Triode Cathode
- Pin 9 - Triode Grid

GRID-NO. 2 INPUT RATING CHART

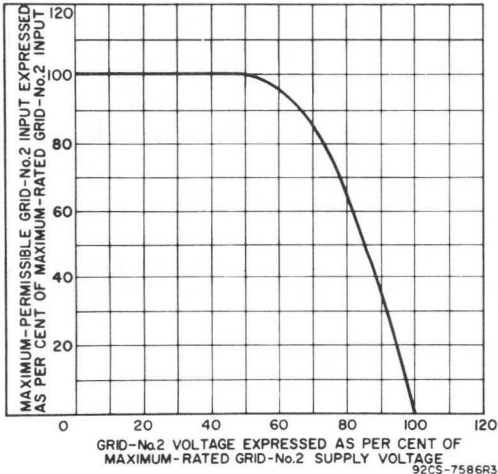

6MU8

DIMENSIONAL OUTLINE JEDEC 6-3

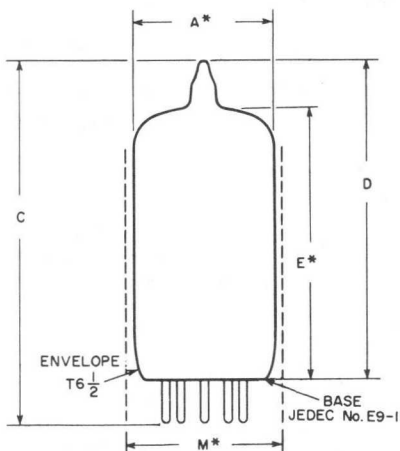

92CS-11893R2

DIMENSION	INCHES			MILLIMETERS		
	Min.	Nom.	Max.	Min.	Nom.	Max.
A*	0.800	-	0.845	20.32	-	21.46
C	-	-	2.625	-	-	66.67
D	-	-	2.375	-	-	60.32
E*	1.906	2.000	2.094	48.41	50.80	53.19
M*	-	-	0.875	-	-	22.22
MILLIMETER DIMENSION DERIVED FROM INCH DIMENSION						
* As defined in the current issue of EIA standards RS-209-A1.						

Medium-Mu Triode

9-PIN MINIATURE TYPE

With Heater Having Controlled Warm-Up Time

GENERAL DATA

Electrical:

Heater, for Unipotential Cathode:

Voltage (AC or DC)	6.3	volts
Current	0.6 ± 6%	amp
Warm-up time (Average)	11	sec

Direct Interelectrode Capacitances (Approx.):^a

Grid to plate	2.4	μmf
Grid to cathode and heater	4.2	μmf
Plate to cathode and heater	0.6	μmf

Characteristics, Class A₁ Amplifier:

Plate Voltage	250	volts
Grid Voltage	-8	volts
Amplification Factor	16.5	
Plate Resistance (Approx.)	3700	ohms
Transconductance	4500	μmhos
Plate Current	24	ma
Plate Current for grid volts = -15	4	ma
Grid Voltage (Approx.) for plate $\mu a = 50$	-22	volts

Mechanical:

Operating Position	Any
Maximum Overall Length	2-5/8"
Maximum Seated Length	2-3/8"
Length, Base Seat to Bulb Top (Excluding tip)	2" ± 3/32"
Diameter	0.750" to 0.875"
Dimensional Outline	See <i>General Section</i>
Bulb	T6-1/2
Base	Small-Button Noval 9-Pin (JEDEC No.E9-1)
Basing Designation for BOTTOM VIEW	9AC

- Pin 1 - Internal Connection—Do Not Use
- Pin 2 - Cathode
- Pin 3 - Grid
- Pin 4 - Heater

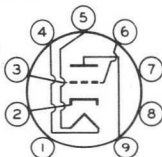

- Pin 5 - Heater
- Pin 6 - Grid
- Pin 7 - Same as Pin 1
- Pin 8 - Same as Pin 1
- Pin 9 - Plate

VERTICAL-DEFLECTION AMPLIFIER

Maximum Ratings, Design-Maximum Values:

For operation in a 525-line, 30-frame system^b

DC PLATE VOLTAGE	550 max.	volts
PEAK POSITIVE-PULSE PLATE VOLTAGE ^c	2200 max.	volts
PEAK NEGATIVE-PULSE GRID VOLTAGE	250 max.	volts

← Indicates a change.



6S4A

CATHODE CURRENT:

Peak	105	max.	ma
Average	30	max.	ma
PLATE DISSIPATION	8.5	max.	watts

PEAK HEATER-CATHODE VOLTAGE:

Heater negative with respect to cathode.	200	max.	volts
Heater positive with respect to cathode.	200 ^d	max.	volts

Maximum Circuit Values:

Grid-Circuit Resistance:

For cathode-bias operation.	2.2	max.	megohms
-------------------------------------	-----	------	---------

^a Without external shield.

^b As described in "Standards of Good Engineering Practice Concerning Television Broadcast Stations," Federal Communications Commission.

^c This rating is applicable where the duration of the voltage pulse does not exceed 15 per cent of one vertical scanning cycle. In a 525-line, 30-frame system, 15 per cent of one vertical scanning cycle is 2.5 milliseconds.

^d The dc component must not exceed 100 volts.



AVERAGE CHARACTERISTICS

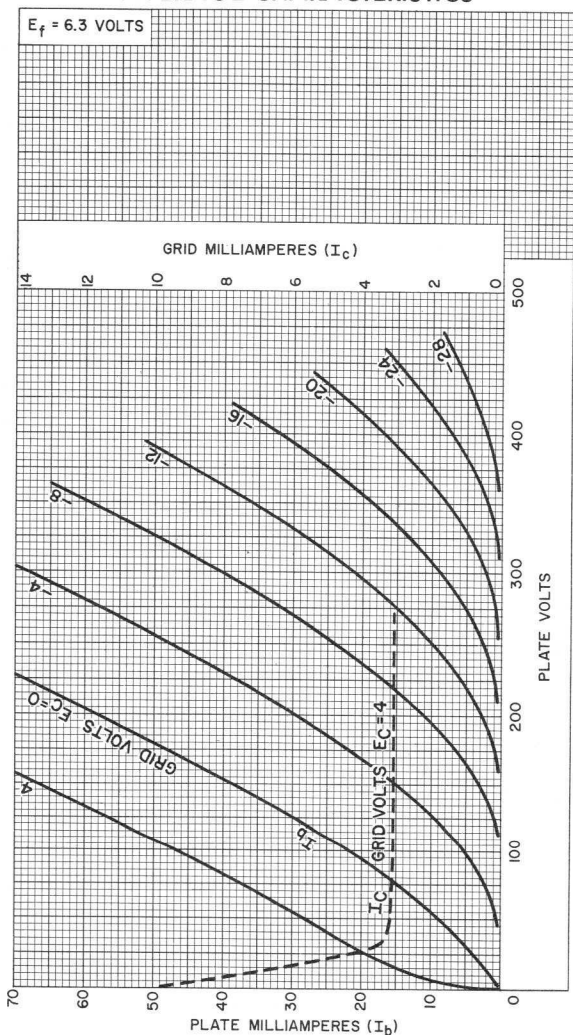

92CM-7373RI







6SA7
6SA7-GT/G

6SA7, 6SA7-GT/G

PENTAGRID CONVERTER

Heater	Coated Unipotential Cathode	
Voltage	6.3	a-c or d-c volts
Current	0.3	amp.
Direct Interelectrode Capacitances:	6SA7	6SA7-GT/G
Grid #3 to All Other Electrodes (R-F Input)	9.5 [▲]	11 ^{▲▲} μf
Plate to All Other Electrodes (Mixer Output)	12 [▲]	11 ^{▲▲} μf
Grid #1 to All Other Electrodes (Osc. Input)	7 [▲]	8 ^{▲▲} μf
Grid #3 to Plate	0.13 max.▲	0.5 max.▲▲μf
Grid #3 to Grid #1	0.15 max.▲	0.4 max.▲▲μf
Grid #1 to Plate	0.06 max.▲	0.2 max.▲▲μf
Grid #1 to Shell, Grid #5, and All Other Electrodes except Cathode	4.4	- μf
Grid #1 to All Other Electrodes except Cathode & Grid #5	-	5 μf
Grid #1 to Cathode	2.6	- μf
Grid #1 to Cathode & Grid #5	-	3 μf
Cathode to Shell, Grid #5, and All Other Electrodes except Grid #1	5	- μf
Cathode and Grid #5 to All Other Electrodes except Grid #1	-	14 μf
Maximum Overall Length	2-5/8"	3-5/16"
Maximum Seated Height	2-1/16"	2-3/4"
Maximum Diameter	1-5/16"	1-5/16"
Bulb	Metal Shell MT-8	T-9
Base	{ Small Wafer { Octal 8-Pin	{ Intermed. Sh. { Octal 8-Pin
Pin 1	{ 6SA7, Shell, Grid #5 { 6SA7-GT/G, No Conn.	
Pin 2	Heater	
Pin 3	Plate	
Pin 4	Grids #2 & #4	
Pin 5	Grid #1	
Pin 6	{ 6SA7, Cathode { 6SA7-GT/G, Cathode & Grid #5	
Pin 7	Heater	
Pin 8	Grid #3	
Mounting Position		Any



Maximum And Minimum Ratings Are Design-Center Values

CONVERTER SERVICE

Plate Voltage	300 max. volts
Grids #2 & #4 Voltage	100 max. volts
Grids #2 & #4 Supply Voltage	300 max. volts
Grid #3 Voltage *	0 min. volts
Plate Dissipation	1.0 max. watt
Screen Dissipation	1.0 max. watt
Total Cathode Current	14 max. ma.

- In circuits where the cathode is not directly connected to the heater, the potential difference between heater and cathode should be kept as low as possible.
- ▲ With shell connected to cathode.
- ▲▲ With external shield connected to cathode.
- * For self-excited oscillator.

← Indicates a change.

Jan. 1, 1943

RCA VICTOR DIVISION
RADIO CORPORATION OF AMERICA, HARRISON, NEW JERSEY

DATA

6SA7
6SA7-GT/G



6SA7, 6SA7-GT/G PENTAGRID CONVERTER

(continued from preceding page)

Characteristics:

	Self-excitation*		Separate Excitation		
Plate Voltage	100	250	100	250	volts
Grids #2 & #4 Volt.	100	100	100	100	volts
Grid #3 (Control) Volt.	0	0	-2	-2	volts
Grid #1 Resistor	20000	20000	20000	20000	ohms
Plate Res. (Approx.)	0.5	1.0	0.5	1.0	megohm
Conversion Transcond.	425	450	425	450	μmhos
Conversion Transcond. (Approx.) †	2	2	2	2	μmhos
Plate Current	3.3	3.5	3.3	3.5	ma.
Grids #2 & #4 Current	8.5	8.5	8.5	8.5	ma.
Grid #1 Current	0.5	0.5	0.5	0.5	ma.
Total Cathode Current	12.3	12.5	12.3	12.5	ma.

NOTE: The transconductance between Grid #1 and Grids #2 & #4 connected to plate (not oscillating) is approximately 4500 μmhos under the following conditions: Grids #1, #3, and shell at 0 volts; Grids #2 & #4 and plate at 100 volts.

* Characteristics are approximate only and are shown for a Hartley circuit with a feedback of approximately 2 volts peak in the cathode circuit.

† With Grid #3 bias of -35 volts.

TYPICAL SELF-EXCITED CONVERTER CIRCUIT FOR TYPE 6SA7

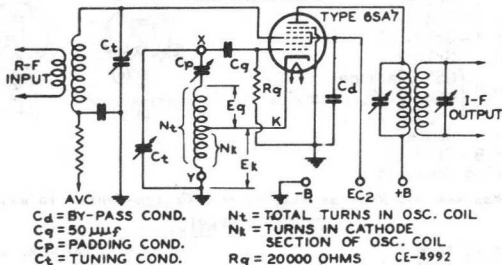

The license extended to the purchaser of tubes appears in the License Notice accompanying them. Information contained herein is furnished without assuming any obligations.



6SA7

6SA7

OPERATION CHARACTERISTICS WITH SELF-EXCITATION

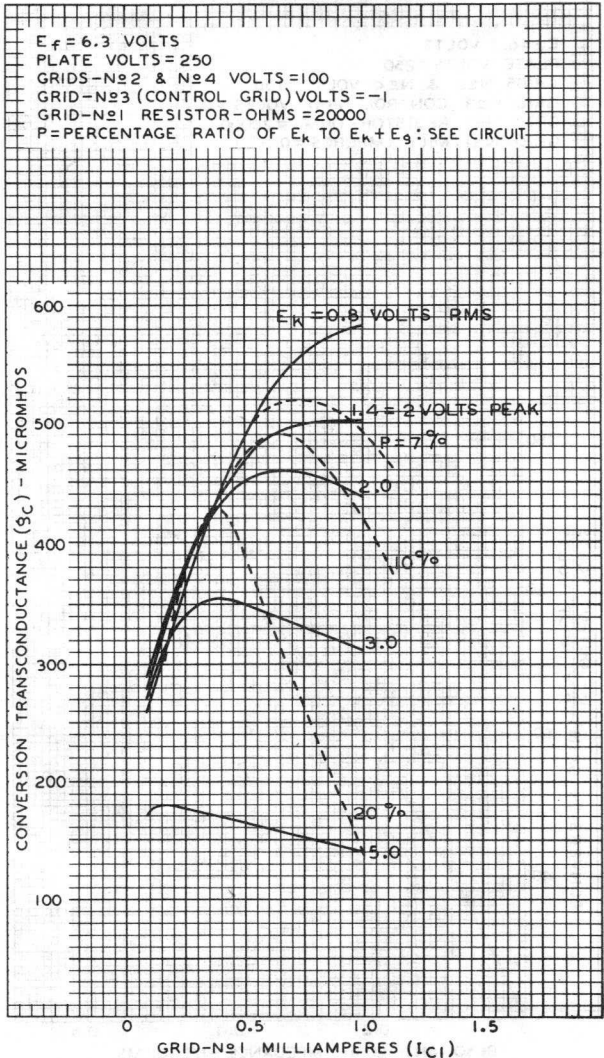

NOV. 2, 1938

RCA RADIOTRON DIVISION
RCA MANUFACTURING COMPANY, INC.

92C-4993

6SA7



6SA7

OPERATION CHARACTERISTIC WITH SELF-EXCITATION

$E_f = 6.3$ VOLTS
 PLATE VOLTS = 250
 GRIDS No 2 & No 4 VOLTS = 100
 GRID No 3 (CONTROL GRID) VOLTS = 0
 GRID No 1 RESISTOR - OHMS = 20000
 GRID No 1 MILLIAMPERES = 0.5

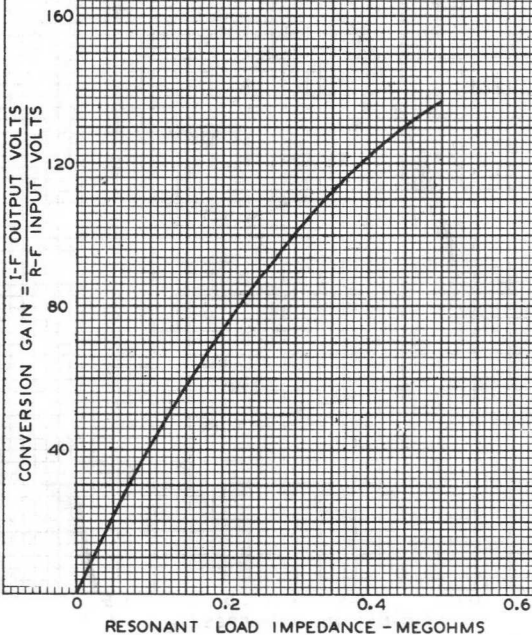

APR. 25, 1941

 RCA RADIOTRON DIVISION
 RCA MANUFACTURING COMPANY, INC.

CE-4994



6SA7

6SA7

OPERATION CHARACTERISTICS

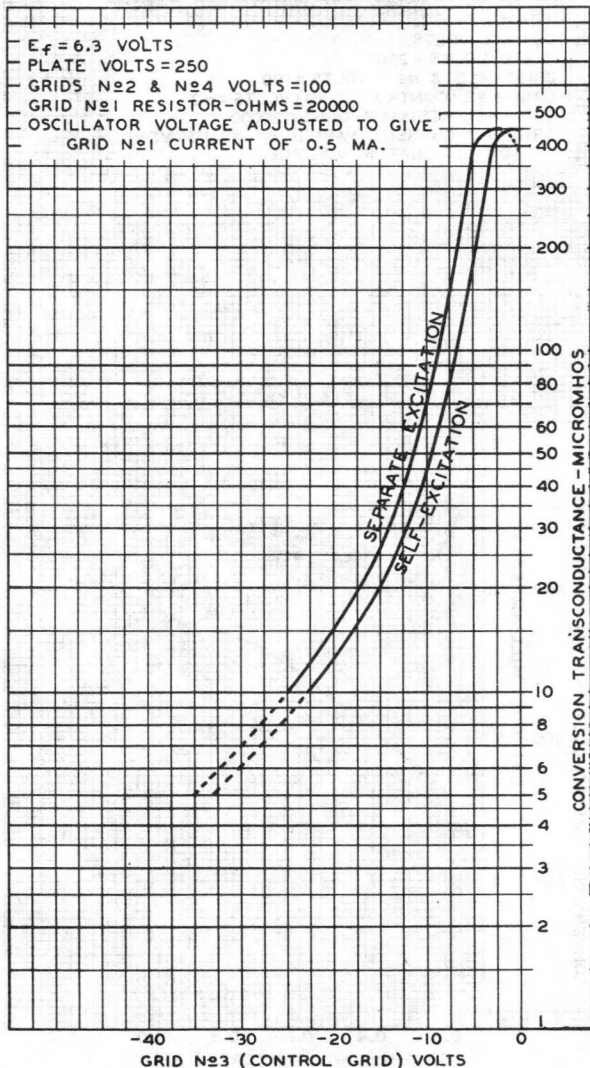

OCT. 25, 1938

RCA RADIOTRON DIVISION
RCA MANUFACTURING COMPANY, INC.

92C-4989

6SA7



6SA7

OPERATION CHARACTERISTICS WITH SEPARATE OSCILLATOR EXCITATION

$E_f = 6.3$ VOLTS
 PLATE VOLTS = 250
 GRIDS-№2 & №4 VOLTS = 100
 GRID-№3 (CONTROL GRID) VOLTS = -2
 GRID-№1 RESISTOR-OHMS = 20000
 GRID-№1 CURRENT VARIED BY ADJUSTMENT
 OF OSCILLATOR VOLTAGE

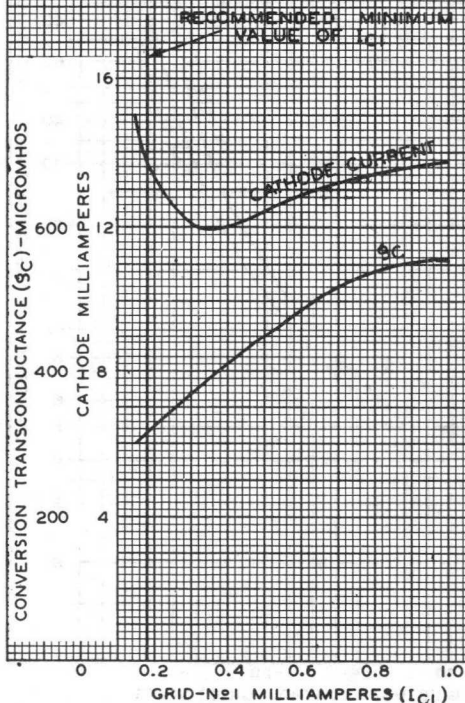

APR. 24, 1941

 RCA RADIOTRON DIVISION
 RCA MANUFACTURING COMPANY, INC.

92C-4990R1



6SJ7
6SJ7-GT

6 SJ7, 6SJ7-GT SHARP-CUTOFF PENTODE

GENERAL DATA

Electrical:

Heater, for Unipotential Cathode:

Voltage. 6.3 ac or dc volts
Current. 0.3 amp

Direct Interelectrode Capacitances:

Pentode Connection:	6SJ7 ⁰	6SJ7-GT ⁰⁰	
Grid No.1 to Plate	0.005 max.	0.005 max.	μμf ←
Input	6	7	μμf ←
Output	7	7	μμf ←
Triode Connection*:			
Grid No.1 to Plate	2.8	2.8	μμf
Grid No.1 to Cathode.	3.4	3.4	μμf
Plate to Cathode	11	11	μμf

⁰ With shell connected to cathode.

⁰⁰ With external shield connected to cathode.

* With grid No.2 and grid No.3 connected to plate.

Mechanical:

Mounting Position.	Any	Any
Maximum Overall Length	2-5/8"	3-5/16"
Maximum Seated Length.	2-1/16"	2-3/4"
Maximum Diameter	1-5/16"	1-5/16"
Bulb	Metal Shell, MT8G	T-9
Base	{ Small-Wafer Octal 8-Pin	Sm.-Wafer Octal 8-Pin, Sleeve
Basing Designation	8N	GT-8N

BOTTOM VIEW

Pin 1 { 6SJ7, Shell
6SJ7-GT,
Base Sleeve

Pin 2 - Heater

Pin 3 - Grid No.3

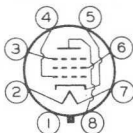

Pin 4 - Grid No.1

Pin 5 - Cathode

Pin 6 - Grid No.2

Pin 7 - Heater

Pin 8 - Plate

AMPLIFIER - Class A₁

Pentode Connection

Maximum Ratings, Design-Center Values:

PLATE VOLTAGE.	300 max.	volts
GRID-No.2 (SCREEN) VOLTAGE	125 max.	volts
GRID-No.2 SUPPLY VOLTAGE	300 max.	volts
PLATE DISSIPATION.	2.5 max.	watts
GRID-No.2 DISSIPATION.	0.7 max.	watt ←
GRID-No.1 (CONTROL-GRID) VOLTAGE:		
Positive bias value.	0 max.	volts ←
PEAK HEATER-CATHODE VOLTAGE:		
Heater negative with respect to cathode	90 max.	volts ←
Heater positive with respect to cathode	90 max.	volts ←

← Indicates a change.

JUNE 15, 1948

TUBE DEPARTMENT
RADIO CORPORATION OF AMERICA, HARRISON, NEW JERSEY

DATA

6SJ7
6SJ7-GT



6SJ7, 6SJ7-GT SHARP-CUTOFF PENTODE

Typical Operation and Characteristics:

Plate voltage.	100	250	..	volts
Grid No.3 (Suppressor) .	Connected to cathode at socket			
Grid-No.2 Voltage.	100	100	..	volts
Grid-No.1 Voltage.	-3	-3	..	volts
Plate Resistance (Approx.)	0.7	#	..	megohm
Transconductance	1575	1650	..	μhos
Grid-No.1 Bias (Approx.) for plate current of 10 μamp	-8	-8	..	volts
Plate Current.	2.9	3.0	..	ma
Grid-No.2 Current.	0.9	0.8	..	ma

Maximum Circuit Values:

Grid-No.1-Circuit Resistance	1 max.	megohm
--	--------	--------

AMPLIFIER - Class A₁

Triode Connection - Grids No.2 and No.3 Connected to Plate

Maximum Ratings, Design-Center Values:

PLATE VOLTAGE.	250 max.	volts
PLATE DISSIPATION (Total).	2.5 max.	watts
GRID-NO.1 VOLTAGE:		
Positive bias value.	0 max.	volts
→ PEAK HEATER-CATHODE VOLTAGE:		
Heater negative with respect to cathode.	90 max.	volts
Heater positive with respect to cathode.	90 max.	volts

Typical Operation and Characteristics:

Plate Voltage.	180	250	..	volts
Grid-No.1 Voltage.	-6	-8.5	..	volts
Amplification Factor	19	19		
Plate Resistance (Approx.)	8250	7600	..	ohms
Transconductance	2300	2500	..	μhos
Plate Current.	6.0	9.2	..	ma

Maximum Circuit Values:

Grid-No.1-Circuit Resistance	1 max.	megohm
--	--------	--------

Greater than 1 megohm.

*For additional data, see RESISTANCE-COUPLED AMPLIFIER CHART
at the front of this Section*

→ Indicates a change.



6SJ7

6SJ7

AVERAGE PLATE CHARACTERISTICS PENTODE CONNECTION

$E_f = 6.3$ VOLTS
GRID-N^o2 VOLTS = 100
GRID-N^o3 VOLTS = 0

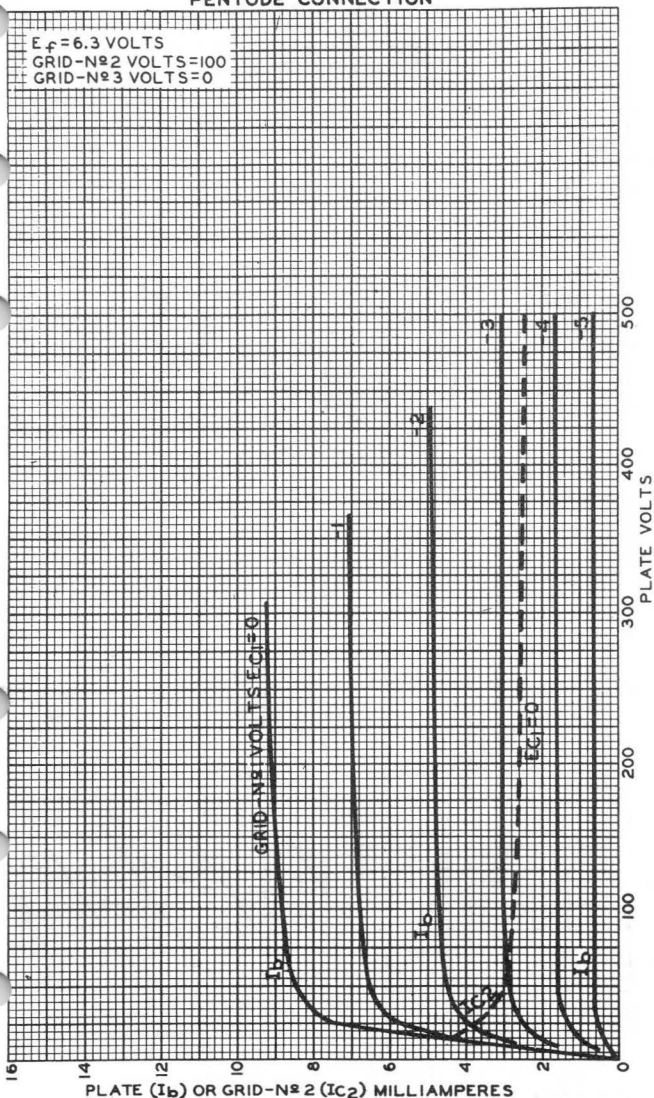

OCT. 16, 1947

TUBE DEPARTMENT
RADIO CORPORATION OF AMERICA, HARRISON, NEW JERSEY

92CM-4939R1

6SJ7



6SJ7

AVERAGE CHARACTERISTICS PENTODE CONNECTION

 $E_f = 6.3$ VOLTS

PLATE VOLTS = 300

GRID-N^o3 VOLTS = 0

CURVE	GRID-N ^o 2 SUPPLY VOLTS	SERIES GRID-N ^o 2 RESISTOR-OHMS
1	125	—
2	100	—
3	75	—
4	50	—
5	25	—
6	300	250000

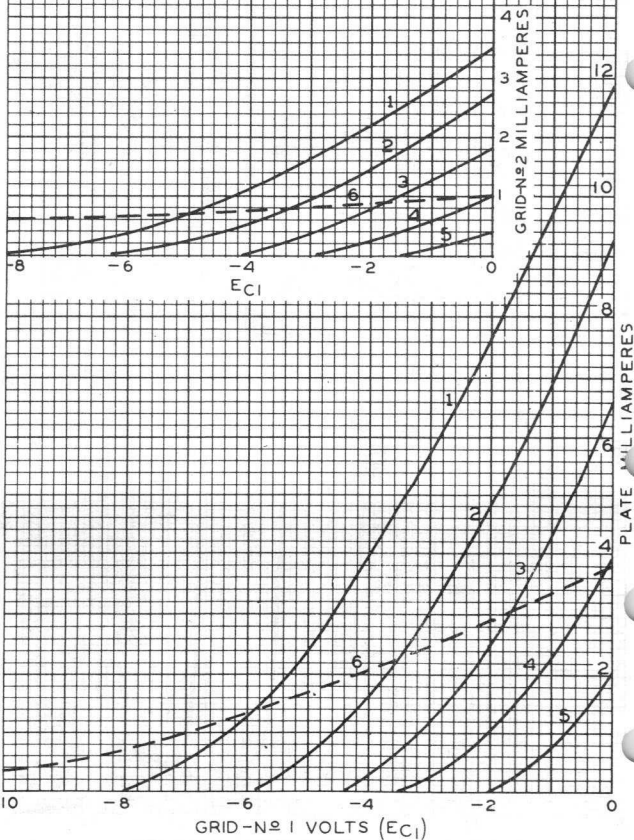

MARCH 5, 1948

TUBE DEPARTMENT

92CM-6443R1

RADIO CORPORATION OF AMERICA, HARRISON, NEW JERSEY



6SJ7

6SJ7

AVERAGE CHARACTERISTICS PENTODE CONNECTION

$E_f = 6.3$ VOLTS PLATE VOLTS = 300 GRID-N \circ 3 VOLTS = 0

CURVE	GRID-N \circ 2-SUPPLY VOLTS	SERIES GRID-N \circ 2 RESISTOR-OHMS
1	125	—
2	100	—
3	75	—
4	50	—
5	25	—
6	300	250000

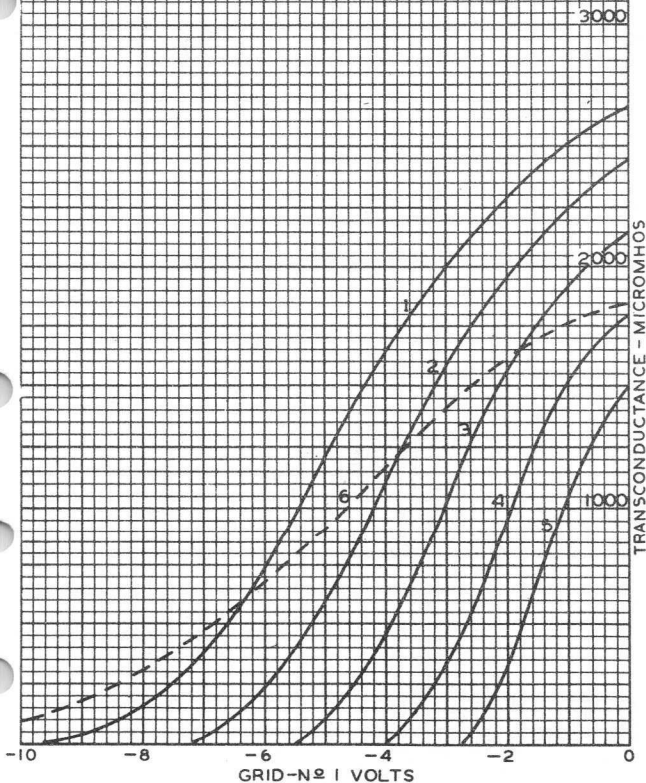

MARCH 5, 1948

TUBE DEPARTMENT
RADIO CORPORATION OF AMERICA, HARRISON, NEW JERSEY

92CM-6444RI

6SJ7



6SJ7

AVERAGE CHARACTERISTICS PENTODE CONNECTION

$E_f = 6.3$ VOLTS
GRID-N $\#$ 3 VOLTS = 0

PLATE VOLTS = 250
GRID-N $\#$ 2 VOLTS = 100

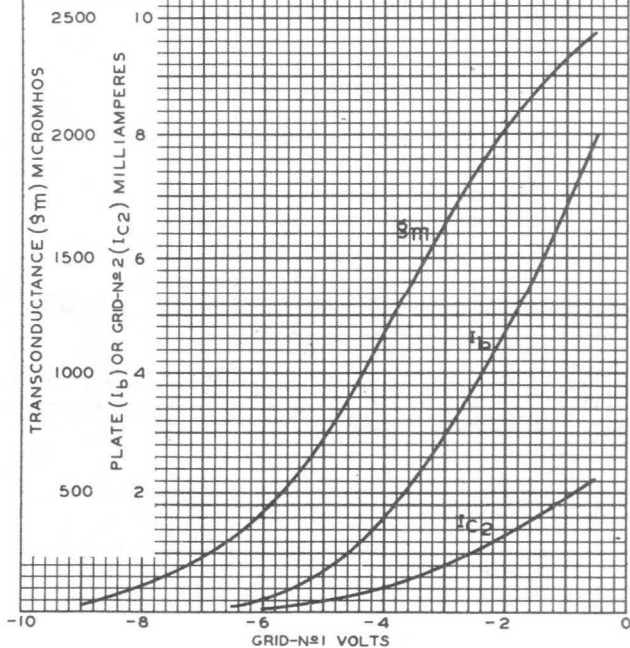

MARCH 5, 1948

TUBE DEPARTMENT
RADIO CORPORATION OF AMERICA, HARRISON, NEW JERSEY

92CM-4937R1



6SJ7

6SJ7

AVERAGE PLATE CHARACTERISTICS TRIODE CONNECTION

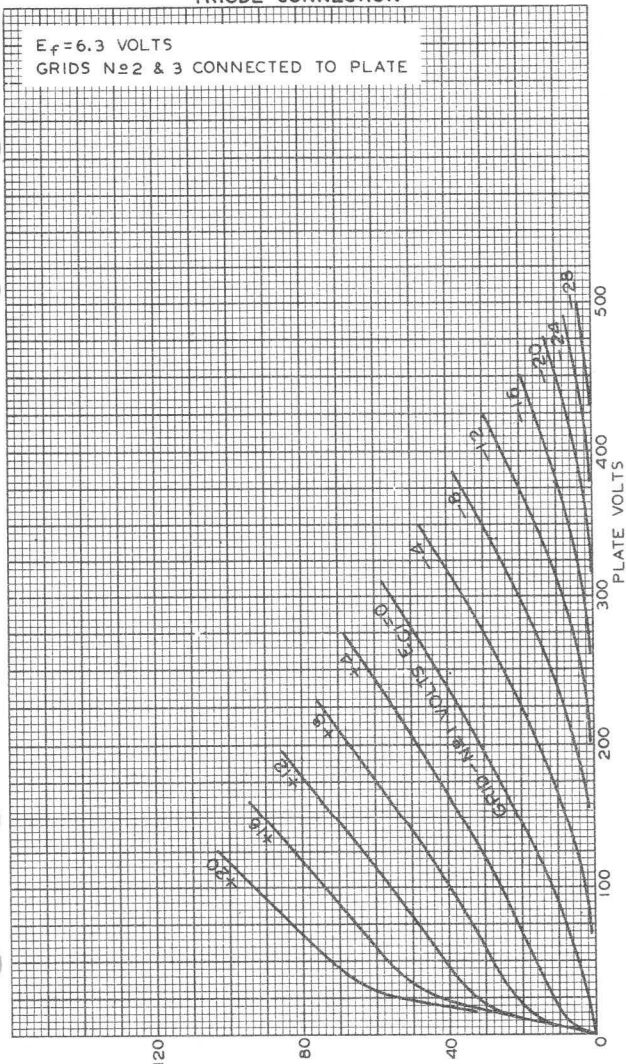

MAY 12, 1948

PLATE MILLIAMPERES
TUBE DEPARTMENT
RADIO CORPORATION OF AMERICA, HARRISON, NEW JERSEY

92CM-6409R1





6SL7-GT

6SL7-GT

HIGH-MU TWIN TRIODE

GENERAL DATA

Electrical:

Heater, for Unipotential Cathodes:

Voltage 6.3 ac or dc volts

Current 0.3 amp

Direct Interelectrode Capacitances (Approx.):^o

	Unit No. 1	Unit No. 2	
Grid to plate	2.8	2.8	μf
Grid to cathode and heater	3.0	3.4	μf
Plate to cathode and heater	3.8	3.2	μf

Mechanical:

Mounting Position Any

Maximum Overall Length 3-5/16"

Maximum Seated Length 2-3/4"

Maximum Diameter 1-9/32"

Bulb T-9

Base Intermediate-Shell Octal 8-Pin (JETEC No. 88-6)

or Short Intermediate-Shell Octal 8-Pin (JETEC No. 88-46)

Basing Designation for BOTTOM VIEW 8B0

Pin 1-Grid of
Unit No. 2

Pin 2-Plate of
Unit No. 2

Pin 3-Cathode of
Unit No. 2

Pin 4-Grid of
Unit No. 1

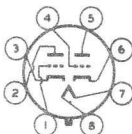

Pin 5-Plate of
Unit No. 1

Pin 6-Cathode of
Unit No. 1

Pin 7-Heater

Pin 8-Heater

AMPLIFIER—Class A₁

Values are for Each Unit

Maximum Ratings, Design-Center Values:

PLATE VOLTAGE 300 max. volts

GRID VOLTAGE:

Positive bias value 0 max. volts

PLATE DISSIPATION 1 max. watt

PEAK HEATER-CATHODE VOLTAGE:

Heater negative with respect to cathode 90 max. volts

Heater positive with respect to cathode 90 max. volts

Characteristics:

Plate Voltage 250 volts

^o With close-fitting shield (JETEC No. 308) connected to cathode.

←Indicates a change.

6SL7-GT



6SL7-GT

HIGH-MU TWIN TRIODE

Grid Voltage	-2	volts
Amplification Factor	70	
Plate Resistance (Approx.)	44000	ohms
Transconductance	1600	μ mhos
Plate Current.	2.3	ma

→ Typical Operation as Resistance-Coupled Amplifier:

See RESISTANCE-COUPLED AMPLIFIER CHART No. 7
at front of this Section

→ indicates a change.

NOV. 5, 1954

TUBE DIVISION

RADIO CORPORATION OF AMERICA, HARRISON, NEW JERSEY

DATA



6SL7-GT

6SL7-GT

AVERAGE PLATE CHARACTERISTICS EACH TRIODE UNIT

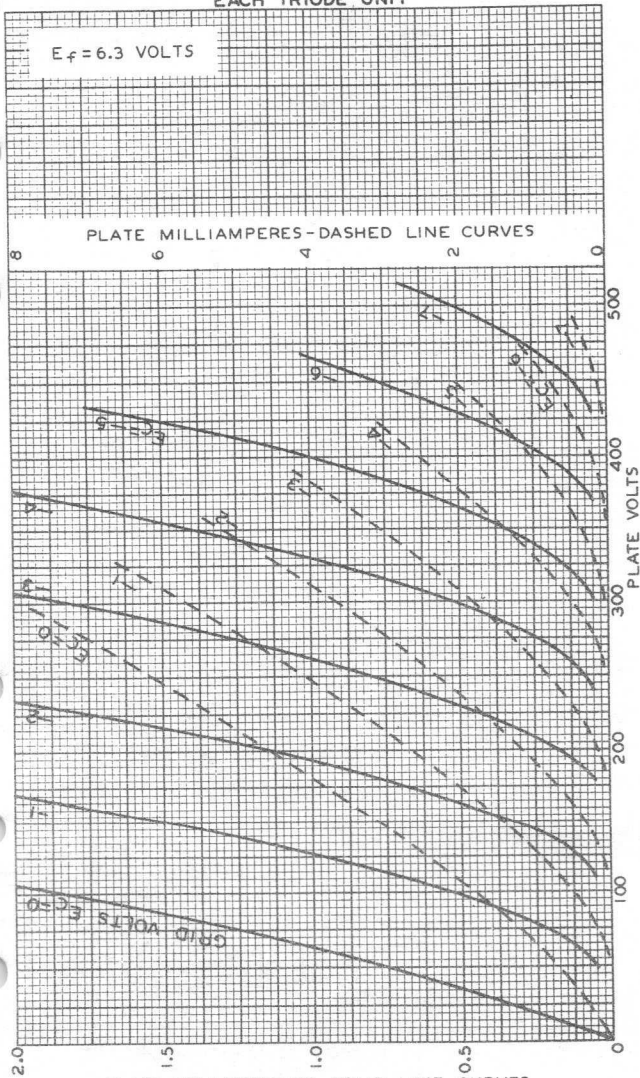

JUNE 16, 1941

TUBE DIVISION
RADIO CORPORATION OF AMERICA, HARRISON, NEW JERSEY

92CM - 6298

STATISTICS

Year	1950	1951	1952	1953	1954	1955	1956	1957	1958	1959	1960
Population	100	100	100	100	100	100	100	100	100	100	100
...



6SN7-GTA

MEDIUM-MU TWIN TRIODE

6SN7-GTA

GENERAL DATA

Electrical:

Heater, for Unipotential Cathodes:

Voltage	6.3	ac or dc volts
Current	0.6	amp

Direct Interelectrode Capacitances (With no external shield):

	Unit No.1	Unit No.2	
Grid to plate	4	3.8	$\mu\mu\text{f}$
Grid to cathode and heater . .	2.2	2.6	$\mu\mu\text{f}$
Plate to cathode and heater . .	0.7	0.7	$\mu\mu\text{f}$

Characteristics, Class A₁ Amplifier (Each Unit):

Plate Voltage	90	250	volts
Grid Voltage	0	-8	volts
Amplification Factor	20	20	volts
Plate Resistance (Approx.) . . .	6700	7700	ohms
Transconductance	3000	2600	μmhos
Plate Current	10	9	ma
Plate Current for grid voltage of -12.5 volts	-	1.3	ma
Grid Voltage (Approx.) for plate current of 10 μamp	-7	-18	volts

Mechanical:

Mounting Position	Any
Maximum Overall Length	3-5/16"
Maximum Seated Length	2-3/4"
Maximum Diameter	1-9/32"
Bulb	T-9
Base	Short Intermediate-Shell Octal 8-Pin with External Barriers (JETEC No. BB-58)
Basing Designation for BOTTOM VIEW	8BD

- Pin 1 - Grid of Unit No.2
- Pin 2 - Plate of Unit No.2
- Pin 3 - Cathode of Unit No.2
- Pin 4 - Grid of Unit No.1

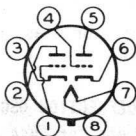

- Pin 5 - Plate of Unit No.1
- Pin 6 - Cathode of Unit No.1
- Pin 7 - Heater
- Pin 8 - Heater

AMPLIFIER - Class A₁

Values are for Each Unit

Maximum Ratings, Design-Center Values:

PLATE VOLTAGE	450 max.	volts
CATHODE CURRENT	20 max.	ma

6SN7-GTA



6SN7-GTA

MEDIUM-MU TWIN TRIODE

PLATE DISSIPATION:

Either plate	5	max.	watts
Both plates (Both units operating) . . .	7.5	max.	watts

PEAK HEATER-CATHODE VOLTAGE:

Heater negative with respect to cathode	200	max.	volts
Heater positive with respect to cathode	200 [▲]	max.	volts

Maximum Circuit Values:

Grid-Circuit Resistance:
For fixed-bias operation 1 max. megohm

Typical Operation as Resistance-Coupled Amplifier:

See RESISTANCE-COUPLED AMPLIFIER CHART No. 29 at front of this Section

HORIZONTAL DEFLECTION OSCILLATOR

Values are for Each Unit

Maximum Ratings, Design-Center Values:

For operation in a 525-line, 30-frame system[□]

DC PLATE VOLTAGE	450	max.	volts
PEAK NEGATIVE-PULSE GRID VOLTAGE [♣]	600	max.	volts

CATHODE CURRENT:

Peak	300	max.	ma
Average	20	max.	ma

PLATE DISSIPATION:

Either plate	5	max.	watts
Both plates (Both units operating) . . .	7.5	max.	watts

PEAK HEATER-CATHODE VOLTAGE:

Heater negative with respect to cathode	200	max.	volts
Heater positive with respect to cathode	200 [▲]	max.	volts

Maximum Circuit Values:

Grid-Circuit Resistance:
For fixed-bias, grid-resistor bias, or cathode-bias operation 2.2 max. megohms

VERTICAL DEFLECTION OSCILLATOR

Values are for Each Unit

Maximum Ratings, Design-Center Values:

For operation in a 525-line, 30-frame system[□]

DC PLATE VOLTAGE	450	max.	volts
PEAK NEGATIVE-PULSE GRID VOLTAGE [#]	400	max.	volts

CATHODE CURRENT:

Peak	70	max.	ma
Average	20	max.	ma

[▲], [□], [♣], [#]: See next page.



6SN7-GTA

6SN7-GTA

MEDIUM-MU TWIN TRIODE

PLATE DISSIPATION:

Either plate	5 max.	watts
Both plates (Both units operating) . . .	7.5 max.	watts

PEAK HEATER-CATHODE VOLTAGE:

Heater negative with respect to cathode	200 max.	volts
Heater positive with respect to cathode	200 [▲] max.	volts

Maximum Circuit Values:

Grid-Circuit Resistance:

For fixed-bias, grid-resistor bias, or cathode-bias operation	2.2 max.	megohms
--	----------	---------

VERTICAL DEFLECTION AMPLIFIER

Values are for Each Unit

Maximum Ratings, Design-Center Values Except as Noted:

For operation in a 525-line, 30-frame system[□]

DC PLATE VOLTAGE	450 max.	volts
----------------------------	----------	-------

PEAK POSITIVE-PULSE PLATE VOLTAGE [#] (Absolute Maximum) . . .	1500 [■] max.	volts
--	------------------------	-------

PEAK NEGATIVE-PULSE GRID VOLTAGE	250 max.	volts
--	----------	-------

CATHODE CURRENT:

Peak	70 max.	ma
Average	20 max.	ma

PLATE DISSIPATION:

Either plate	5 max.	watts
Both plates (Both units operating) . . .	7.5 max.	watts

PEAK HEATER-CATHODE VOLTAGE:

Heater negative with respect to cathode	200 max.	volts
Heater positive with respect to cathode	200 [▲] max.	volts

Maximum Circuit Values:

Grid-Circuit Resistance:

For cathode-bias operation	2.2 max.	megohms
--------------------------------------	----------	---------

- ▲ The dc component must not exceed 100 volts.
- As described in "Standards of Good Engineering Practice Concerning Television Broadcast Stations", Federal Communications Commission.
- ♣ This rating is applicable where the duration of the voltage pulse does not exceed 15 per cent of one horizontal scanning cycle. In a 525-line, 30-frame system, 15 per cent of one horizontal scanning cycle is 10 microseconds.
- # This rating is applicable where the duration of the voltage pulse does not exceed 15 per cent of one vertical scanning cycle. In a 525-line, 30-frame system, 15 per cent of one vertical scanning cycle is 2.5 milliseconds.
- under no circumstances should this absolute value be exceeded.

6SN7-GTA



6SN7-GTA

AVERAGE PLATE CHARACTERISTICS FOR EACH UNIT

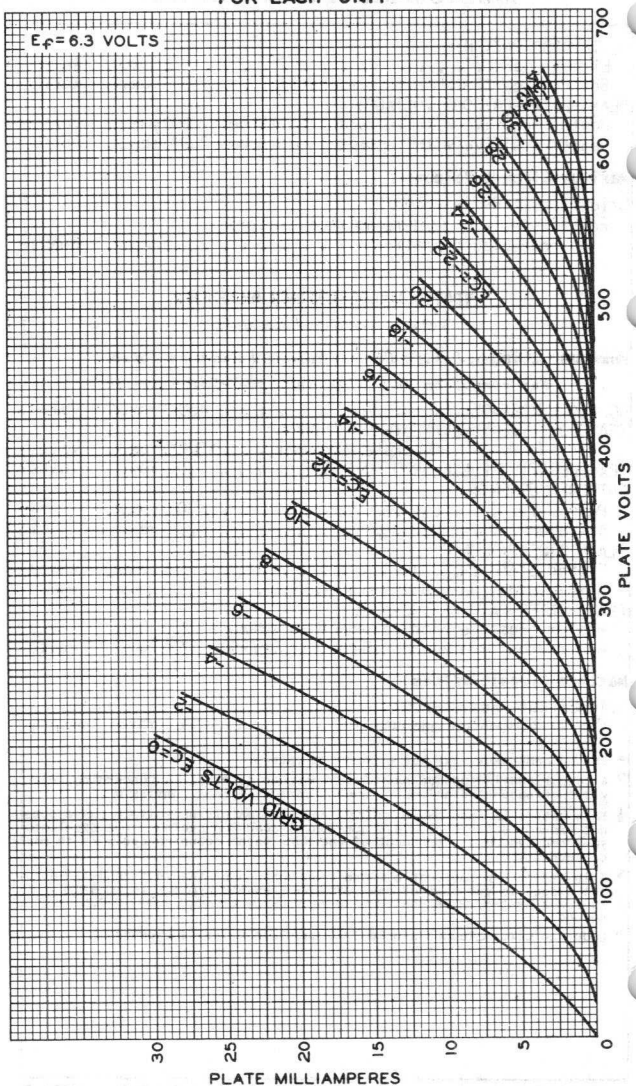

APRIL 28, 1954

TUBE DIVISION
RADIO CORPORATION OF AMERICA, HARRISON, NEW JERSEY

92CM-8322



6SN7-GTA

6SN7-GTA

AVERAGE CHARACTERISTICS FOR EACH UNIT

$E_f = 6.3$ VOLTS
PLATE VOLTS (E_b) = 250

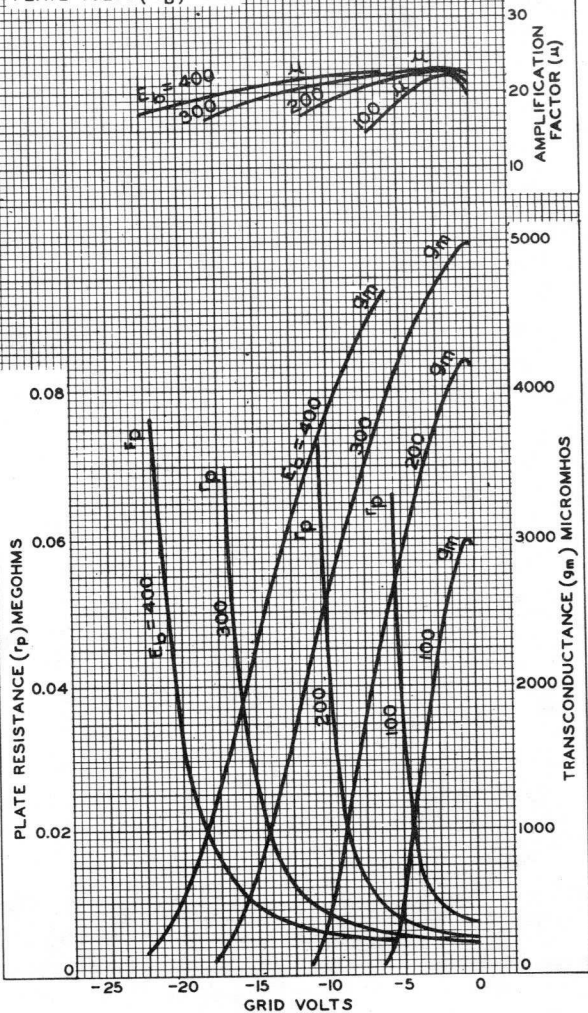

OCT. 14, 1953

TUBE DIVISION
RADIO CORPORATION OF AMERICA, HARRISON, NEW JERSEY

92CM-8122

1944

1945

1946

1947

1948

1949

1950

1951

1952

1953

1954

1955

1956

1957

1958

1959

1960

1961

1962

1963

1964

1965

1966

1967

1968

1969

1970

1971

1972

1973

1974

1975

1976

1977

1978

1979

1980

1981

1982

1983

1984

1985

1986

1987

1988

1989

1990

1991

1992

1993

1994

1995

1996

1997

1998

1999

2000

2001

2002

2003

2004

2005

2006

2007

2008

2009

2010

2011

2012

2013

2014

2015

2016

2017

2018

2019

2020

2021

2022

2023

2024

2025





6SN7-GTB

6SN7-GTB

MEDIUM-MU TWIN TRIODE

*Intended for use in equipment having
series heater-string arrangement*

The 6SN7-GTB is the same as the 6SN7-GTA except for the following item:

Heater, for Unipotential Cathodes:

Warm-up time (Average) . 11sec

For definition of heater warm-up time and method of determining it, see sheet HEATER WARM-UP TIME MEASUREMENT at front of this Section.

FORM 1041

INCOME TAX RETURN

For the year ended 12/31/54

Name of taxpayer (Last, first, and middle initial)

Address (Street, city, state, and zip)

Occupation

Marital status (Single, Married, Widowed, Divorced)

Number of dependents

Signature of taxpayer



6SQ7
6SQ7-GT/G

6SQ7, 6SQ7-GT/G

DUPLEX-DIODE HIGH-MU TRIODE

		Coated Unipotential Cathode	
Heater Voltage	6.3	a-c or d-c volts	
Current	0.3	amp.	
Direct Interelectrode Cap.	6SQ7 ▲	6SQ7-GT/G ●	
<i>Triode Unit:</i>			
Grid to Plate	1.6	1.8	μf
Grid to Cathode	3.2	4.2	μf
Plate to Cathode	3.0	3.4	μf
Maximum Overall Length	2-5/8"	3-5/16"	
Maximum Seated Height	2-1/16"	2-3/4"	
Maximum Diameter	1-5/16"	1-5/16"	
Bulb	Metal Shell, MT-8	T-9	
Base	{ Small Wafer Octal 8-Pin 8Q	{ Small Wafer Octal 8-Pin, Sleeve GT-8Q	
Basing Designation		Pin 4 - Diode Plate #2	
Pin 1 { 6SQ7, Shell 6SQ7-GT/G, Base Sleeve		Pin 5 - Diode Plate #1	
Pin 2 - Triode Grid		Pin 6 - Triode Plate	
Pin 3 - Cathode		Pin 7 - Heater	
Mounting Position		Pin 8 - Heater	

BOTTOM VIEW

Maximum Ratings Are Design-Center Values

TRIODE UNIT

Plate Voltage	300 max. volts	
D-C Heater-Cathode Potential	100 max. volts	
<i>Characteristics - Class A₁ Amplifier:</i>		
Heater	6.3	6.3 volts
Plate	100	250 volts
Grid	-1	-2 volts
Amp. Fact.	100	100
Plate Res.	110000	91000 ohms
Transcond.	900	1100 μmhos
Plate Cur.	0.4	0.9 ma.

Typical Operation—Resistance-Coupled Amplifier:

Same as Type 75 in RESISTANCE-COUPLED AMPLIFIER CHART.

DIODE UNITS—Two

Consideration of these units is given under Type 85. Circuits will be similar to those shown for Type 55 with fixed bias. Diode biasing of the triode unit of the 6SQ7 or 6SQ7-GT/G is not suitable. Diode curves under Type 6B7 apply to the 6SQ7 and 6SQ7-GT/G.

- ▲ with shell connected to cathode. Values are approximate.
- with no external shield. Values are approximate.

The curve under Type 75 also applies to the 6SQ7 and the 6SQ7-GT/G.

← Indicates a change.

DEC. 1, 1943

RCA VICTOR DIVISION
RADIO CORPORATION OF AMERICA, HARRISON, NEW JERSEY

DATA

6SQ7



6SQ7

AVERAGE PLATE CHARACTERISTICS TRIODE UNIT

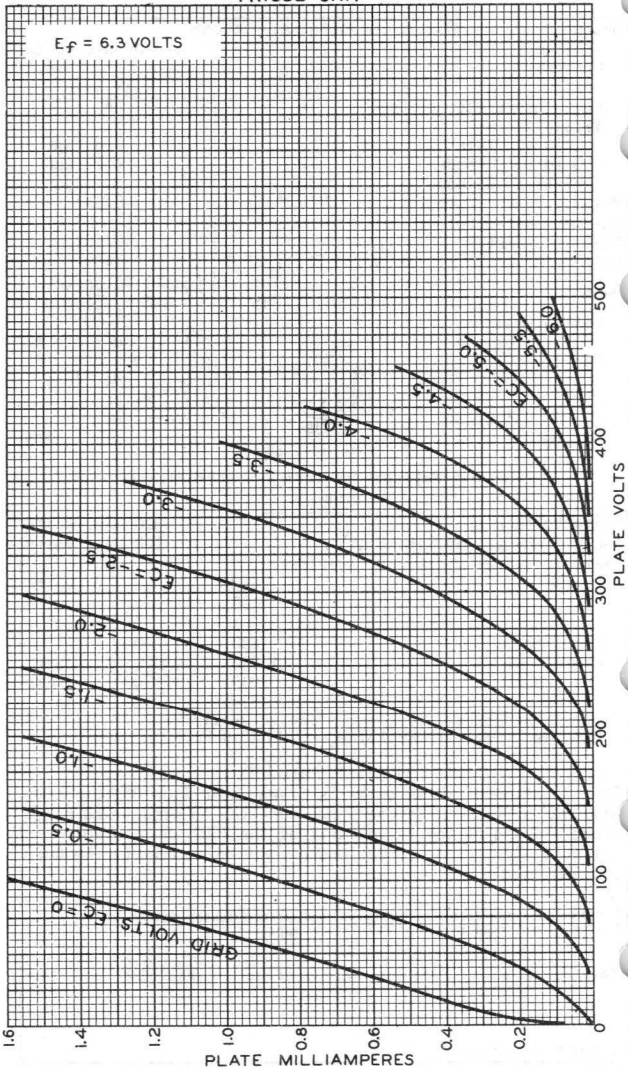

DEC. 14, 1943

RCA VICTOR DIVISION
RADIO CORPORATION OF AMERICA HARRISON, NEW JERSEY

92CM-4975R2



6SQ7

6SQ7

AVERAGE PLATE CHARACTERISTICS TRIODE UNIT

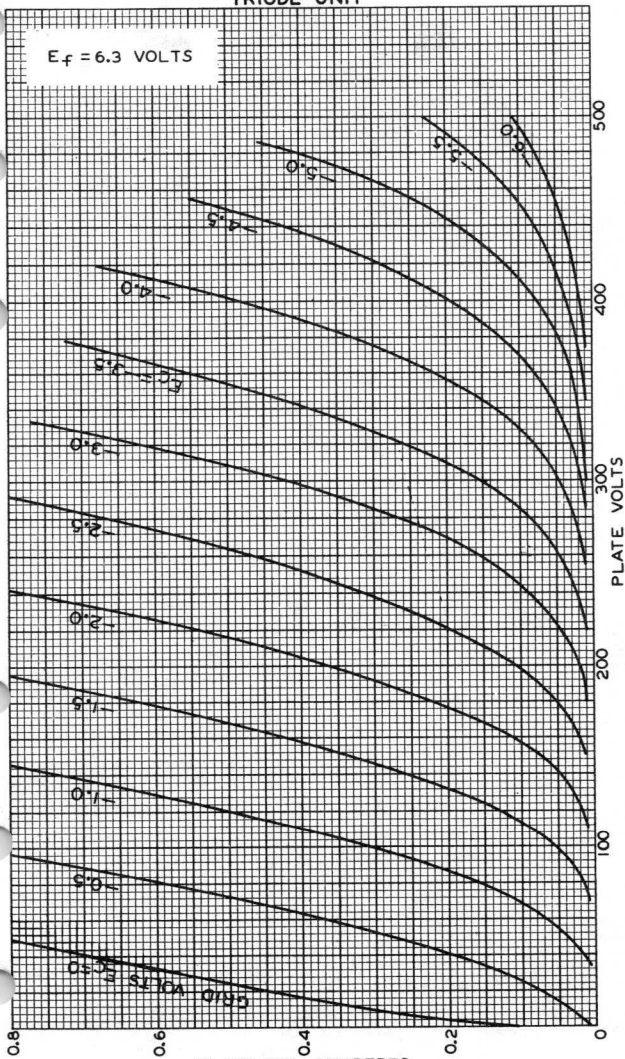

AUG. 13, 1941

RCA RADIODRON DIVISION
RCA MANUFACTURING COMPANY, INC.

92C-6310

1983

STATE OF TEXAS

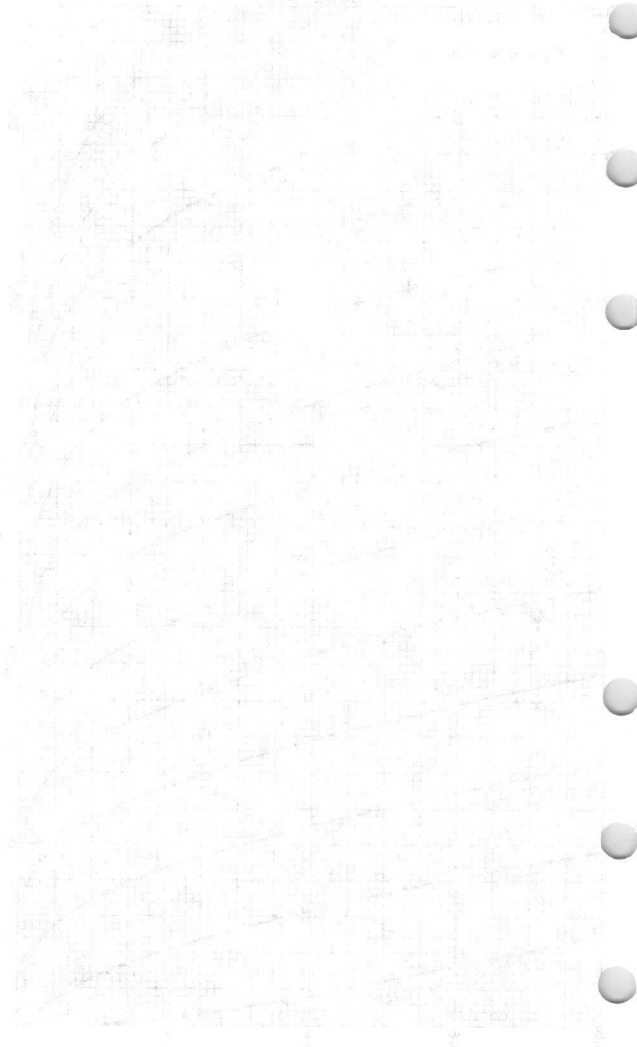



6T8-A

6T8-A

TRIPLE DIODE-HIGH-MU TRIODE

9-PIN MINIATURE TYPE

With heater having controlled warm-up time

GENERAL DATA

Electrical:

Heater, for Unipotential Cathodes:

Voltage	6.3	ac or dc volts
Current	0.45 ± 6%	amp
Warm-up time (Average).	11	sec

For definition of heater warm-up time and method of determining it, see sheet HEATER WARM-UP TIME MEASUREMENT at front of this Section.

Direct Interelectrode Capacitances:

	Without External Shield	With External Shield*	
<i>Triode Unit:</i>			
Grid to plate	1.7	1.7	μf
Grid to cathode & internal shield (pin 7), and heater.	1.6	1.7	μf
Plate to cathode & internal shield (pin 7), and heater.	1.2	2.4	μf
<i>Diode Units:</i>			
Diode-No.1 plate to cathode & internal shield (pin 7), and heater.	3.8	3.8	μf
Diode-No.2 plate to cathode & internal shield (pin 3), and heater.	3.8	3.8 [•]	μf
Diode-No.3 plate to cathode & internal shield (pin 7), and heater.	3.4	3.6	μf
Diode-No.2 cathode & internal shield (pin 3) to all other electrodes, and heater.	7.5	8.5 [■]	μf
Triode grid to any diode plate	0.034 max.	0.034 max.	μf

Characteristics, Class A₁ Amplifier (Triode Unit):

Plate Voltage	100	250	volts
Grid Voltage.	-1	-3	volts
Amplification Factor.	70	70	
Plate Resistance (Approx.).	54000	58000	ohms
Transconductance.	1300	1200	μmhos
Plate Current	0.8	1	ma

Mechanical:

Operating Position.	Any
Maximum Overall Length.	2-3/16"

* , • , ■ : See next page.

6T8-A



6T8-A

TRIPLE DIODE—HIGH-MU TRIODE

Maximum Seated Length 1-15/16"
 Length, Base Seat to Bulb Top (Excluding tip) . 1-9/16" ± 3/32"
 Diameter. 0.750" to 0.875"
 Dimensional Outline See *General Section*
 Bulb. T6-1/2
 Base. Small-Button Noval 9-Pin (JEDEC No.E9-1)

Basing Designation for BOTTOM VIEW. 9E
 Pin 1—Diode—No.3 Plate
 Pin 2—Diode—No.2 Plate
 Pin 3—Diode—No.2 Cathode, Internal Shield
 Pin 4—Heater
 Pin 5—Heater
 Pin 6—Diode—No.1 Plate
 Pin 7—Cathode of Triode & Diodes No.1 & No.3, Internal Shield
 Pin 8—Triode Grid
 Pin 9—Triode Plate

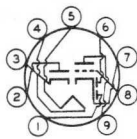

TRIODE UNIT — AMPLIFIER — Class A₁

Maximum Ratings, Design-Maximum Values.

PLATE VOLTAGE. 330 max. volts
 GRID VOLTAGE:
 Positive-bias value. 0 max. volts
 PLATE DISSIPATION. 1.1 max. watts
 PEAK HEATER-CATHODE VOLTAGE:
 Heater negative with respect to cathode. 100 max. volts
 Heater positive with respect to cathode. 100 max. volts

Typical Operation as Resistance-Coupled Amplifier:

See *RESISTANCE-COUPLED AMPLIFIER CHART No.7*
 at front of this Section

DIODE UNITS — Three

Maximum Ratings, Design-Maximum Values:

PLATE CURRENT (For each diode) 5.5 max. ma
 PEAK HEATER-CATHODE VOLTAGE:
 Heater negative with respect to cathode. 100 max. volts
 Heater positive with respect to cathode. 100 max. volts

Characteristics (Each Unit):

Plate Voltage. 5 volts
 Plate Current. 20 ma

Diode Considerations:

Diode No.1, diode No.3, and the triode have a common cathode, and diode No.2 has a separate cathode. Diode No.2 (pins 2 & 3) and diode No.3 (pins 1 & 7) are recommended for use in FM detector applications, while diode No.1 (pins 6 & 7) is recommended for use as an AM detector.



6T8-A

6T8-A

TRIPLE DIODE—HIGH-MU TRIODE

- * With external shield JEDEC No.315 connected to pin 7 except as noted.
- With external shield JEDEC No.315 connected to pin 3.
- With external shield JEDEC No.315 connected to pins 4 and 5.

6T8-A



6T8-A

AVERAGE PLATE CHARACTERISTICS TRIODE UNIT

$E_f = 6.3$ VOLTS

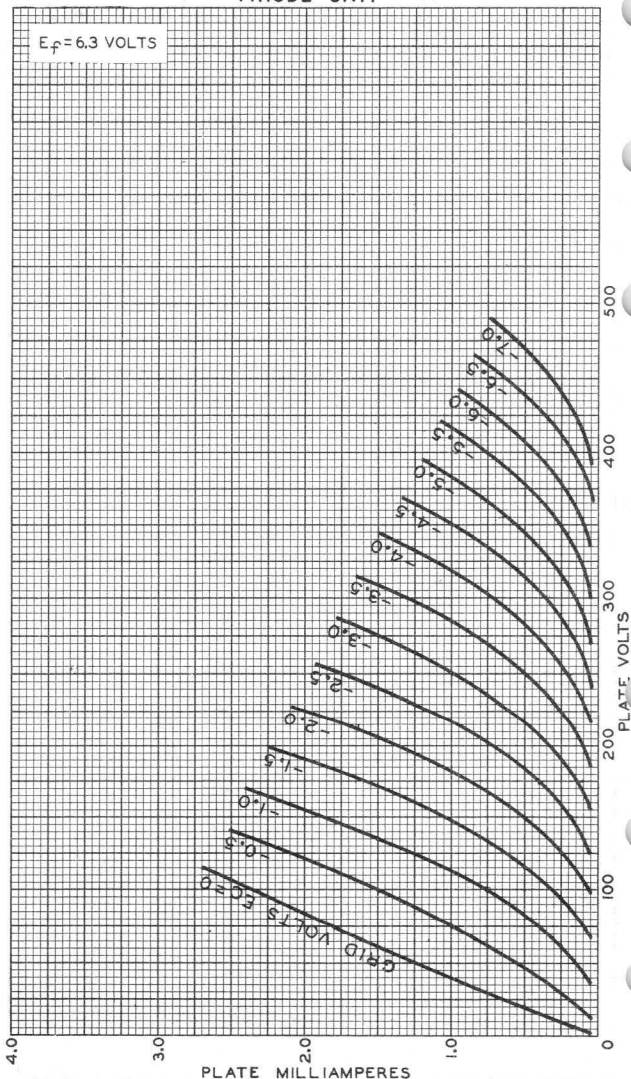

PLATE MILLIAMPERES

ELECTRON TUBE DIVISION

RADIO CORPORATION OF AMERICA, HARRISON, NEW JERSEY

92CM-7063



6T8-A

AVERAGE CHARACTERISTICS TRIODE UNIT

6T8-A

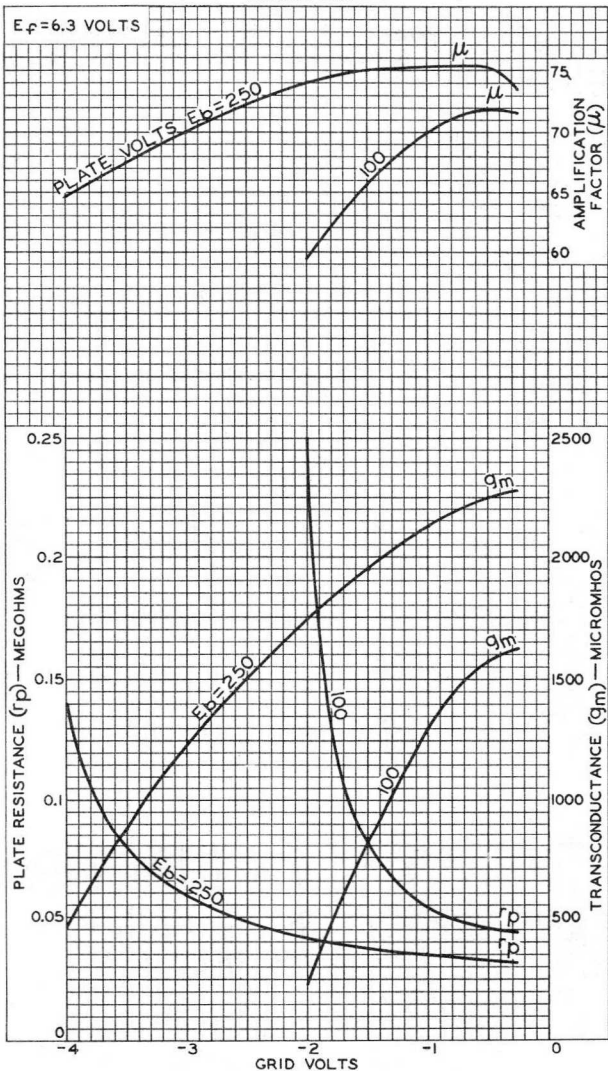

6T8-A



6T8-A

AVERAGE CHARACTERISTICS
HALF-WAVE CIRCUIT—EACH DIODE UNIT

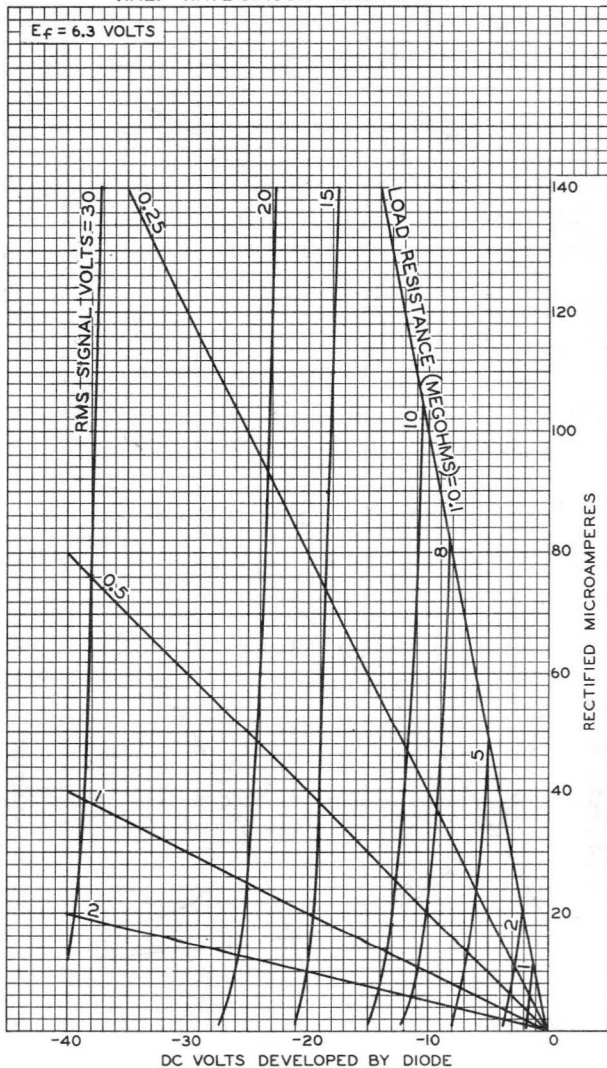

Medium-Mu Triode— Sharp-Cutoff Pentode

9-PIN MINIATURE TYPE

With Heater Having Controlled Warm-Up Time

GENERAL DATA

Electrical:

Heater, for Unipotential Cathodes:

Voltage (AC or DC)	6.3	volts
Current	0.45 ± 6%	amp
Warm-up time (Average)	11	sec

Direct Interelectrode Capacitances:

	Without External Shield	With External Shield [▲]	
Triode Unit:			
Grid to plate	1.8	1.8	μf
Grid to cathode and heater	2.8	2.8	μf
Plate to cathode and heater	1.5	2	μf
Pentode Unit:			
Grid No.1 to plate	0.015 max.	0.007 max.	μf
Grid No.1 to cathode & grid No.3 & internal shield, grid No.2, and heater	5	5	μf
Plate to cathode & grid No.3 & internal shield, grid No.2, and heater	2.6	3.5	μf
Pentode grid No.1 to triode plate	0.2 max.	0.2 max.	μf
Pentode plate to triode plate	0.1 max.	0.02 max.	μf
Heater to cathode (Each unit)	3	3 [•]	μf

Characteristics, Class A₁ Amplifier:

	Triode Unit	Pentode Unit		
Plate Voltage	125	100	125	volts
Grid-No.2 Voltage	-	70	110	volts
Grid-No.1 Voltage	-1	-	-1	volt
Amplification Factor	40	-	-	
Plate Resistance (Approx.)	5400	-	200000	ohms
Transconductance	7500	5500	5000	μmhos
Plate Current	13.5	-	9.5	ma
Grid-No.2 Current	-	-	3.5	ma
Grid-No.1 Voltage (Approx.) for plate μ _a = 20	-9	-	-8	volts

← Indicates a change.



6U8-A

Mechanical:

Operating Position. Any
 Maximum Overall Length. 2-3/16"
 Maximum Seated Length. 1-15/16"
 Length, Base Seat to Bulb Top (Excluding tip). . . 1-9/16" ± 3/32"
 → Diameter. 0.750" to 0.875"
 Dimensional Outline. See *General Section*
 Bulb. T6-1/2
 Base. Small-Button Noval 9-Pin (JEDEC No. E9-1)
 Basing Designation for BOTTOM VIEW. 9AE

Pin 1 - Triode Plate
 Pin 2 - Pentode
 Grid No.1
 Pin 3 - Pentode
 Grid No.2
 Pin 4 - Heater
 Pin 5 - Heater
 Pin 6 - Pentode Plate

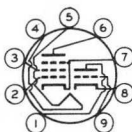

Pin 7 - Pentode
 Cathode,
 Pentode
 Grid No.3,
 Internal
 Shield
 Pin 8 - Triode Cathode
 Pin 9 - Triode Grid

AMPLIFIER — Class A₁

Maximum Ratings, Design-Maximum Values:

	Triode Unit	Pentode Unit	
PLATE VOLTAGE	330 max.	330 max.	volts
GRID-No.2 (SCREEN-GRID) SUPPLY VOLTAGE.	-	330 max.	volts
GRID-No.2 VOLTAGE	-	See <i>Grid-No.2 Input</i>	

Rating Chart at front of Receiving Tube Section

GRID-No.1 (CONTROL-GRID) VOLTAGE:			
Positive-bias value	0 max.	0 max.	volts
GRID-No.2 INPUT:			

For grid-No.2 voltages up to 165 volts	-	0.55 max.	watt
For grid-No.2 voltages between 165 and 330 volts	-	See <i>Grid-No.2 Input</i>	

Rating Chart at front of Receiving Tube Section

PLATE DISSIPATION	2.5 max.	3 max.	watts
PEAK HEATER-CATHODE VOLTAGE:			
Heater negative with respect to cathode.	200 max.	200* max.	volts
Heater positive with respect to cathode.	200 max.	200* max.	volts

Maximum Circuit Values:

	Triode Unit	Pentode Unit	
Grid-No.1-Circuit Resistance:			
For fixed-bias operation.	-	0.5 max.	megohm
For cathode-bias operation.	-	1 max.	megohm

▲ With external shield JEDEC No.315 connected to pin 4 except as noted.

● With external shield JEDEC No.315 connected to pin 6.

* The dc component must not exceed 100 volts.

→ Indicates a change.



AVERAGE CHARACTERISTICS Triode Unit

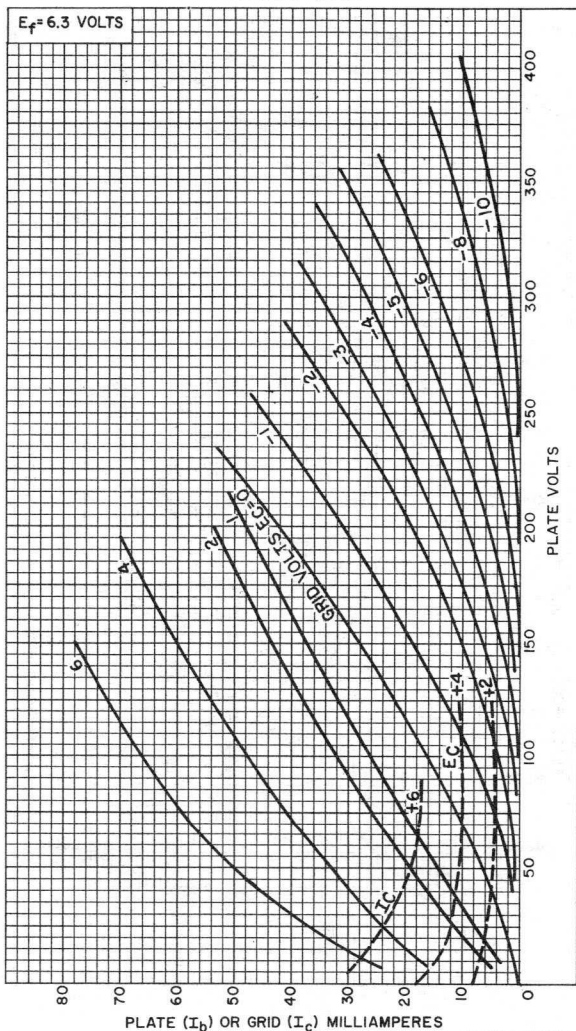

92CM-7873R2



6U8-A

AVERAGE CHARACTERISTICS Triode Unit

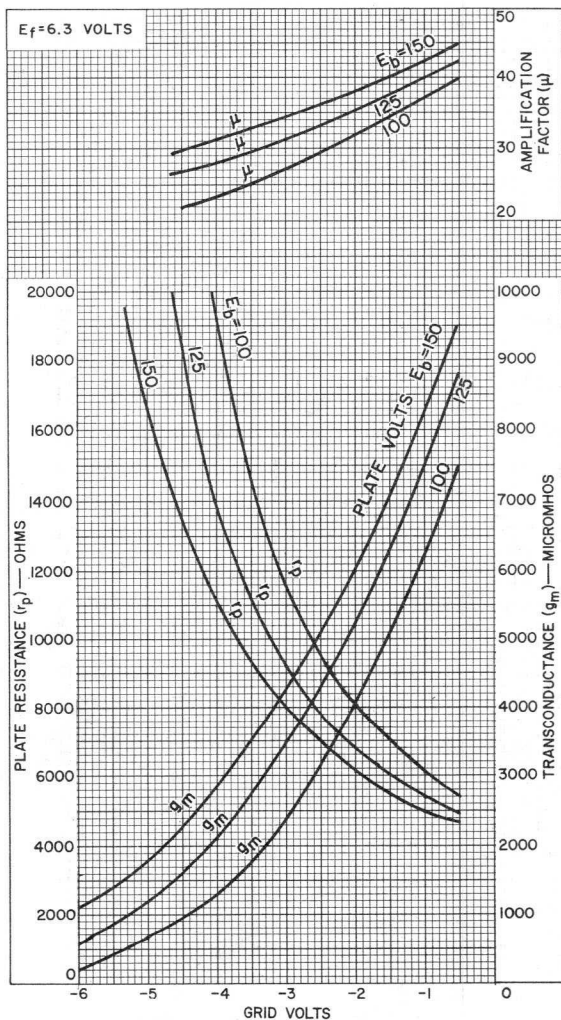

92CM-10900



AVERAGE CHARACTERISTICS Pentode Unit

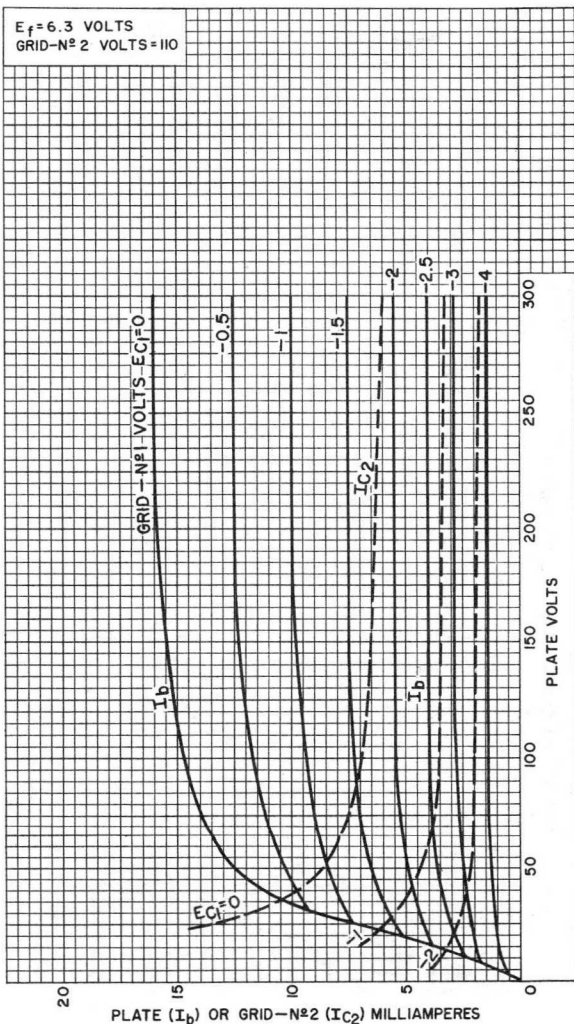

92CM-7869RI



6U8-A

AVERAGE CHARACTERISTICS Pentode Unit

$E_f = 6.3$ VOLTS
PLATE VOLTS = 125
GRID-N^o2 VOLTS = 110

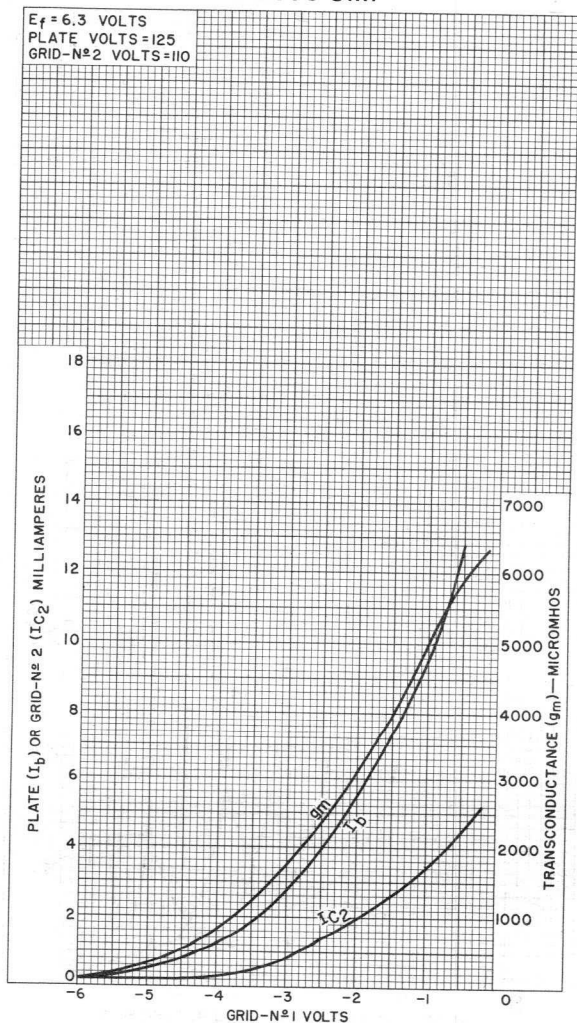

92CM-10902

RADIO CORPORATION OF AMERICA
Electron Tube Division

Harrison, N. J.





6V3-A

6V3-A

HALF-WAVE VACUUM RECTIFIER

9-PIN MINIATURE TYPE

For Television Damper Service

GENERAL DATA

Electrical:

Heater, for Unipotential Cathode:

Voltage	6.3	ac or dc volts
Current	1.75	amp

Direct Interelectrode Capacitances (Approx.):^o

Heater to cathode	1.5	μ f
Plate to cathode and heater	8	μ f
Cathode to plate and heater	9	μ f

Mechanical:

Mounting Position	Any
Maximum Overall Length	3-1/16"
Seated Length	2-21/32" \pm 1/8"
Maximum Diameter	7/8"
Bulb	T-6-1/2
Cap	Skirted Miniature (JETEC No. C1-2 or C1-33)
Base	Small-Button Noval 9-Pin (JETEC No. E9-1)
Basing Designation for BOTTOM VIEW	9BD

Pin 1 - No Connection
 Pin 2 - Plate
 Pin 3 - Same as Pin 1
 Pin 4 - Heater
 Pin 5 - Heater



Pin 6 - Same as Pin 1
 Pin 7 - Plate
 Pin 8 - Same as Pin 1
 Pin 9 - Plate
 Cap - Cathode

DAMPER SERVICE

Maximum Ratings, Design-Center Values Except as Noted:

For operation in a 525-line, 30-frame system^o

PEAK INVERSE PLATE VOLTAGE (Absolute maximum) [#]	6000 [■] max.	volts
PEAK PLATE CURRENT	800 max.	ma
DC PLATE CURRENT	135 max.	ma
PEAK HEATER-CATHODE VOLTAGE: Heater negative with respect to cathode (Absolute maximum) [#]	6750 [▲] max.	volts
Heater positive with respect to cathode	300 [●] max.	volts

^o Without external shield.

[□] As described in "Standards of Good Engineering Practice Concerning Television Broadcast Stations", Federal Communications Commission.

[#] This rating is applicable where the duty cycle of the voltage pulse does not exceed 15 per cent of one horizontal scanning cycle. In a 525-line 30-frame system, 15 per cent of one horizontal scanning cycle is 10 microseconds.

[■] Under no circumstances should this absolute value be exceeded.

[▲] The dc component must not exceed 750 volts.

[●] The dc component must not exceed 100 volts.

MAY 1, 1955

TUBE DIVISION

TENTATIVE DATA

RADIO CORPORATION OF AMERICA, HARRISON, NEW JERSEY

6V3-A



6V3-A

HALF-WAVE VACUUM RECTIFIER

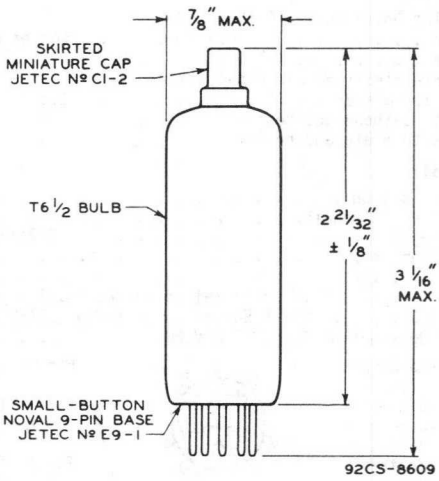

MAY 1, 1955

TUBE DIVISION
RADIO CORPORATION OF AMERICA, HARRISON, NEW JERSEY

CE-8609

Beam Power Tube

With Heater Having Controlled Warm-Up Time

GENERAL DATA

Electrical:

Heater, for Unipotential Cathodes:

Voltage (AC or DC)	6.3	volts
Current	0.45 ± 6%	amp
Warm-up time (Average)	11	sec

Direct Interelectrode Capacitances
(Approx.):^a

Grid-No.1 to plate	0.7	μf
Grid-No.1 to cathode & grid No.3, grid No.2, and heater	9	μf
Plate to cathode & grid No.3, grid No.2, and heater	7.5	μf

Characteristics, Class A₁ Amplifier:

		Triode Connection ^b	
Plate Voltage	250	250	volts
Grid-No.2 Voltage	250	-	volts
Grid-No.1 Voltage	-12.5	-12.5	volts
Amplification Factor	-	9.8	
Plate Resistance (Approx.)	50000	1960	ohms
Transconductance	4100	5000	μmhos
Plate Current	45	49.5	ma
Grid-No.2 Current	4.5	-	ma
Grid-No.1 Voltage (Approx.) for plate ma. = 0.5	-	-36	volts

Mechanical:

Operating Position	Any
Maximum Overall Length	3-5/16"
Maximum Seated Length	2-3/4"
Maximum Diameter	1-9/32"
Dimensional Outline	See <i>General Section</i>
Bulb	T9

Bases (Alternates):

Intermediate-Shell Octal:

7-Pin, Arrangement 1, (JEDEC Group 1, No.B7-7)

6-Pin, Arrangement 2, (JEDEC Group 1, No.B6-81)

Short Intermediate-Shell Octal with External Barriers:

7-Pin, (JEDEC Group 1, No.B7-59)

6-Pin, Arrangement 2, (JEDEC Group 1, No.B6-84)



6V6GTA

Basing Designation for BOTTOM VIEW. 7AC

Pin 1^c - No Connection
 Pin 2 - Heater
 Pin 3 - Plate
 Pin 4 - Grid No.2

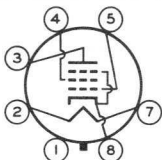

Pin 5 - Grid No.1
 Pin 7 - Heater
 Pin 8 - Cathode, Grid No.3

AF POWER AMPLIFIER — Class A₁

Maximum Ratings, Design-Maximum Values:

PLATE VOLTAGE	350	max.	volts
GRID-No.2 (SCREEN-GRID) VOLTAGE	315	max.	volts
GRID-No.2 INPUT	2.2	max.	watts
PLATE DISSIPATION	14	max.	watts
PEAK HEATER-CATHODE VOLTAGE:			
Heater negative with respect to cathode.	200	max.	volts
Heater positive with respect to cathode.	200 ^d	max.	volts

Typical Operation and Characteristics:

Plate Voltage	180	250	315	volts
Grid-No.2 Voltage	180	250	225	volts
Grid-No.1 (Control-Grid) Voltage.	-8.5	-12.5	-13	volts
Peak AF Grid-No.1 Voltage	8.5	12.5	13	volts
Zero-Signal Plate Current	29	45	34	ma
Max.-Signal Plate Current	30	47	35	ma
Zero-Signal Grid-No.2 Current	3	4.5	2.2	ma
Max.-Signal Grid-No.2 Current	4	7	6	ma
Plate Resistance (Approx.)	50000	50000	80000	ohms
Transconductance.	3700	4100	3750	μmhos
Load Resistance	3500	5000	8500	ohms
Total Harmonic Distortion	8	8	12	%
Max.-Signal Power Output.	2	4.5	5.5	watts

Maximum Circuit Values:

Grid-No.1-Circuit Resistance:		
For fixed-bias operation.	0.1	max. megohm
For cathode-bias operation.	0.5	max. megohm

PUSH-PULL AF POWER AMPLIFIER — Class A₁

Maximum Ratings, Design-Maximum Values:

PLATE VOLTAGE	350	max.	volts
GRID-No.2 (SCREEN-GRID) VOLTAGE	315	max.	volts
GRID-No.2 INPUT	2.2	max.	watts
PLATE DISSIPATION	14	max.	watts
PEAK HEATER-CATHODE VOLTAGE:			
Heater negative with respect to cathode.	200	max.	volts
Heater positive with respect to cathode.	200 ^d	max.	volts



Typical Operation and Characteristics:

Values are for two tubes

Plate Voltage	250	285	volts
Grid-No.2 Voltage	250	285	volts
Grid-No.1 (Control-Grid) Voltage	-15	-19	volts
Peak AF Grid-No.1-to-Grid-No.1 Voltage	30	38	volts
Zero-Signal Plate Current	70	70	ma
Max.-Signal Plate Current	79	92	ma
Zero-Signal Grid-No.2 Current	5	4	ma
Max.-Signal Grid-No.2 Current	13	13.5	ma
Effective Load Resistance (Plate to plate)	10000	8000	ohms
Total Harmonic Distortion	5	3.5	%
Maximum-Signal Power Output	10	14	watts

Maximum Circuit Values:

Grid-No.1-Circuit Resistance: For fixed-bias operation	0.1 max.	megohm
For cathode-bias operation	0.5 max.	megohm

VERTICAL-DEFLECTION AMPLIFIER

Triode Connection — Grid No.2 Connected to Plate

Maximum Ratings, Design-Maximum Values:

For operation in a 525-line, 30-frame system^e

DC PLATE VOLTAGE	350	max.	volts
PEAK POSITIVE-PULSE PLATE VOLTAGE ^f	1200	max.	volts
PEAK NEGATIVE-PULSE GRID-No.1 (CONTROL-GRID) VOLTAGE	275	max.	volts
CATHODE CURRENT:			
Peak	115	max.	ma
Average	40	max.	ma
PLATE DISSIPATION	10	max.	watts
PEAK HEATER-CATHODE VOLTAGE:			
Heater negative with respect to cathode	200	max.	volts
Heater positive with respect to cathode	200 ^d	max.	volts

Maximum Circuit Values:

Grid-No.1-Circuit Resistance: For cathode-bias operation	2.2 max.	megohms
---	----------	---------

^a Without external shield.

^b Grid No.2 connected to plate.

^c On the 6-pin bases, pin 1 as well as pin 6 is omitted.

^d The dc component must not exceed 100 volts.

^e As described in "Standards of Good Engineering Practice Concerning Television Broadcast Stations," Federal Communications Commission.

^f This rating is applicable when the duration of the voltage pulse does not exceed 15 per cent of one vertical scanning cycle. In a 525-line, 30-frame system, 15 per cent of one vertical scanning cycle is 2.5 milliseconds.



6V6GTA

AVERAGE CHARACTERISTICS

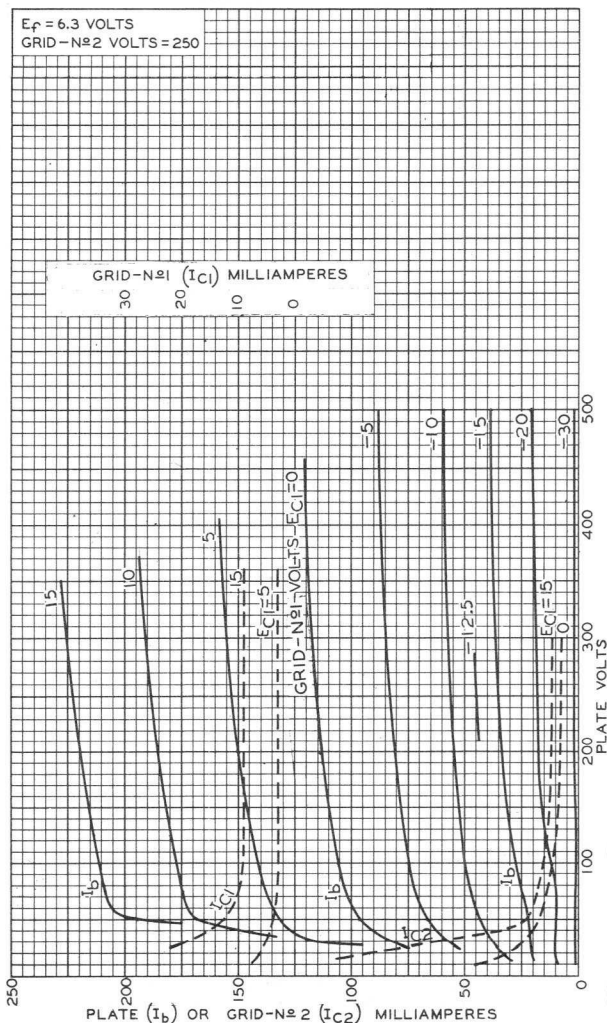

92CM-4807R2



OPERATION CHARACTERISTICS

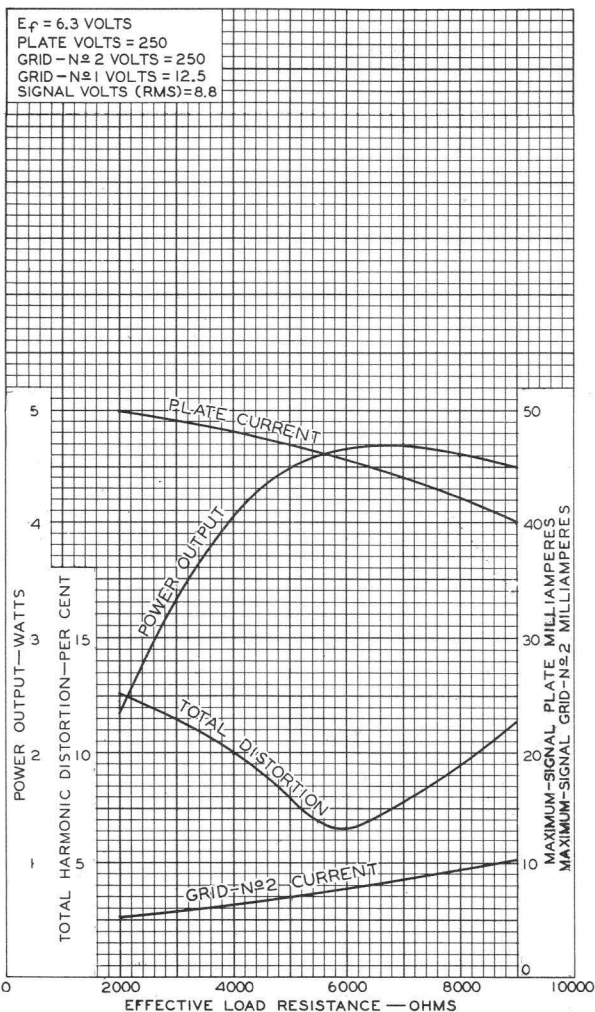

92CM-6339R2



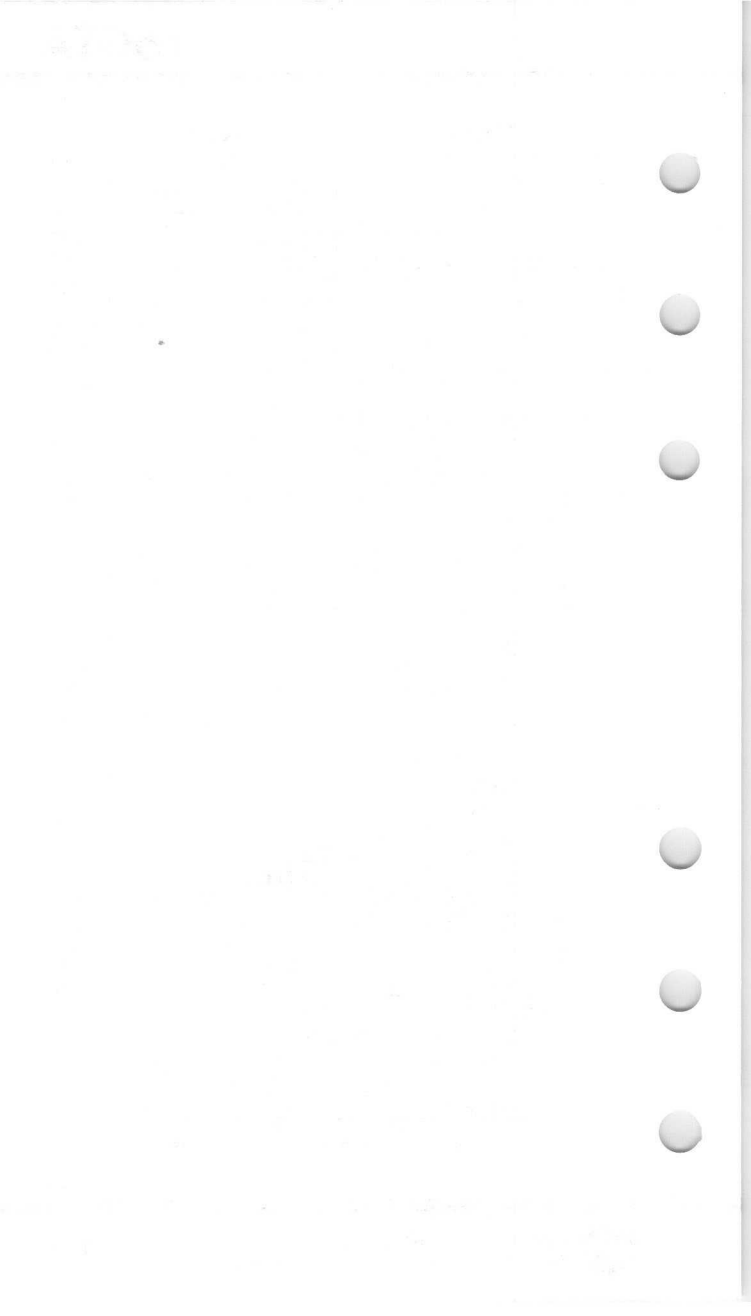

Half-Wave Vacuum Rectifier

For Television Damper Service

GENERAL DATA

Electrical:

Heater, for Unipotential Cathode:

Voltage (AC or DC) 6.3 volts
Current 1.2 amp

Direct Interelectrode Capacitances (Approx.):^a

Plate to cathode and heater 6 $\mu\mu\text{f}$
Cathode to plate and heater 13 $\mu\mu\text{f}$
Heater to cathode 7 $\mu\mu\text{f}$

Mechanical:

Operating Position. Any
Maximum Overall Length. 3-5/16"
Maximum Seated Length 2-3/4"
Maximum Diameter. 1-9/32"
Dimensional Outline See *General Section*
Bulb. T9

Bases (Alternates):

Intermediate-Shell Octal:

6-Pin, Arrangement 1 (JEDEC Group 1, No. B6-8)

5-Pin, Arrangement 2 (JEDEC Group 1, No. B5-82)

Short Intermediate-Shell Octal with External Barriers:

6-Pin, Arrangement 1 (JEDEC Group 1, No. B6-60)

5-Pin, Arrangement 2 (JEDEC Group 1, No. B5-85)

Basing Designation for BOTTOM VIEW. 4CG

Pin 1^b - Same as Pin 2

Pin 2 - Internal Connection Do Not Use^c

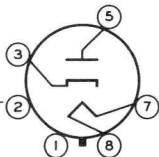

Pin 3 - Cathode
Pin 5 - Plate
Pin 7 - Heater
Pin 8 - Heater

DAMPER SERVICE

Maximum Ratings, Design-Center Values Except as Noted:

For operation in a 525-line, 30-frame system^d

PEAK INVERSE PLATE VOLTAGE

(Absolute maximum)^e 3850^f max. volts

PEAK PLATE CURRENT 750 max. ma

DC PLATE CURRENT 125 max. ma

PLATE DISSIPATION. 3.5 max. watts

PEAK HEATER-CATHODE VOLTAGE:

Heater negative with respect to cathode. 2300^g max. volts

Heater positive with respect to cathode. 300^h max. volts

← Indicates a change.



6W4GT

Characteristics, Instantaneous Value:

Tube Voltage Drop for plate ma. = 250. . . . 21 volts

- a Without external shield.
- b On the 5-pin bases, pin 1 as well as pins 4 and 6 is omitted.
- c Socket terminals 1, 2, 4 and 6 should not be used as tie points.
- d As described in "Standards of Good Engineering Practice Concerning Television Broadcast Stations," Federal Communications Commission.
- e This rating is applicable when the duty cycle of the voltage pulse does not exceed 15 per cent of one horizontal scanning cycle. In a 525-line, 30-frame system, 15 per cent of one horizontal scanning cycle is 10 micro-seconds.
- f Under no circumstances should this absolute-maximum value be exceeded.
- g The dc component (Absolute maximum) must not exceed 500 volts.
- h The dc component must not exceed 100 volts.





6W6-GT

6W6-GT

BEAM POWER AMPLIFIER

GENERAL DATA

Electrical:

Heater, for Unipotential Cathode:

Voltage	6.3	ac or dc volts
Current	1.2	amp

Direct Interelectrode Capacitances (Approx.):

Grid No.1 to Plate . . .	0.5 max.	$\mu\mu\text{f}$
Input	15	$\mu\mu\text{f}$
Output	9	$\mu\mu\text{f}$

Characteristics as Beam Power Amplifier:

See AMPLIFIER—Class A₁ below:

Characteristics as Triode-Connected Amplifier:

(Grid No.2 connected to plate)

Plate Voltage	225	volts
Grid-No.1 Voltage	-30	volts
Amplification Factor	6.2	
Plate Resistance	1600	ohms
Transconductance	3800	μmhos
Plate Current	22	ma
Grid-No.1 Voltage (Approx.) for plate current of 0.5 ma	-42	volts ←

Mechanical:

Mounting Position	Any
Maximum Overall Length	3-5/16"
Maximum Seated Length	2-3/4"
Maximum Diameter	1-9/32"
Bulb	T-9 ←

Base. Intermediate-Shell Octal 6-Pin (JETEC No. B6-8) ←
 or Intermediate-Shell Octal 7-Pin (JETEC No. B7-7)
 or Short Intermediate-Shell Octal 6-Pin with Ex-
 ternal Barriers (JETEC No. B6-60)
 or Short Intermediate-Shell Octal 7-Pin with Ex-
 ternal Barriers (JETEC No. B7-59)

Basing Designation for BOTTOM VIEW G-7AC

Pin 1—No
 Connection
 Pin 2—Heater
 Pin 3—Plate
 Pin 4—Grid No.2

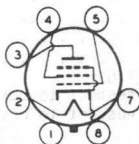

Pin 5—Grid No.1
 Pin 7—Heater
 Pin 8—Cathode,
 Grid No.3

AMPLIFIER—Class A₁

Maximum Ratings, Design-Center Values:

PLATE VOLTAGE	300 max.	volts
GRID-No.2 (SCREEN) VOLTAGE	150 max.	volts
PLATE DISSIPATION	10 max.	watts
GRID-No.2 INPUT	1.25 max.	watts

← Indicates a change.

OCT. 1, 1953

TUBE DEPARTMENT

TENTATIVE DATA

RADIO CORPORATION OF AMERICA, HARRISON, NEW JERSEY

6W6-GT



6W6-GT

BEAM POWER AMPLIFIER

PEAK HEATER-CATHODE VOLTAGE:

Heater negative with respect to cathode	200 max.	volts
Heater positive with respect to cathode	200 [▲] max.	volts

Typical Operation and Characteristics:

Plate Supply Voltage	110	200	volts
Grid-No.2 Voltage	110	125	volts
Grid-No.1 (Control-Grid) Voltage	-7.5	-	volts
Cathode-Bias Resistor	-	180	ohms
Peak AF Grid-No.1 Voltage	7.5	8.5	volts
Zero-Signal Plate Current	49	46	ma
Max.-Signal Plate Current	50	47	ma
Zero-Signal Grid-No.2 Current	4	2.2	ma
Max.-Signal Grid-No.2 Current	10	8.5	ma
Plate Resistance (Approx.)	13000	28000	ohms
Transconductance	8000	8000	μmhos
Load Resistance	2000	4000	ohms
Total Harmonic Distortion (Approx.)	10	10	%
Max.-Signal Power Output	2.1	3.8	watts

Maximum Circuit Values:

Grid-No.1-Circuit Resistance:

For fixed-bias operation	0.1 max.	megohm
For cathode-bias operation	0.5 max.	megohm

VERTICAL DEFLECTION AMPLIFIER

Triode Connected--Grid No.2 Connected to Plate

Maximum Ratings, Design-Center Values Except As Noted:

*For operation in a 525-line, 30-frame system**

DC PLATE VOLTAGE	300 max.	volts
PEAK POSITIVE-PULSE PLATE VOLTAGE ^o	1200 [▲] max.	volts
PEAK NEGATIVE-PULSE GRID-No.1 (CONTROL-GRID) VOLTAGE	-250 max.	volts
CATHODE CURRENT:		
Peak	140 max.	ma
DC	40 max.	ma
PLATE DISSIPATION	7.5 max.	watts
PEAK HEATER-CATHODE VOLTAGE:		
Heater negative with respect to cathode	200 max.	volts
Heater positive with respect to cathode	200 [▲] max.	volts

Maximum Circuit Values:

Grid-No.1-Circuit Resistance:

For cathode-bias operation	2.2 max.	megohms
--------------------------------------	----------	---------

[▲] The dc component must not exceed 100 volts.

[●] As described in "Standards of Good Engineering Practice for Television Broadcast Stations", Federal Communications Commission.

^o The duration of the voltage pulse must not exceed 15 per cent of one scanning cycle. In a 525-line, 30-frame system, 15 per cent of one scanning cycle is 2.5 milliseconds.

[▲] under no circumstances should this absolute value be exceeded.

OCT. 1, 1953

TUBE DEPARTMENT

TENTATIVE DATA

RADIO CORPORATION OF AMERICA, HARRISON, NEW JERSEY



6W6-GT

6W6-GT

AVERAGE PLATE CHARACTERISTICS PENTODE CONNECTION

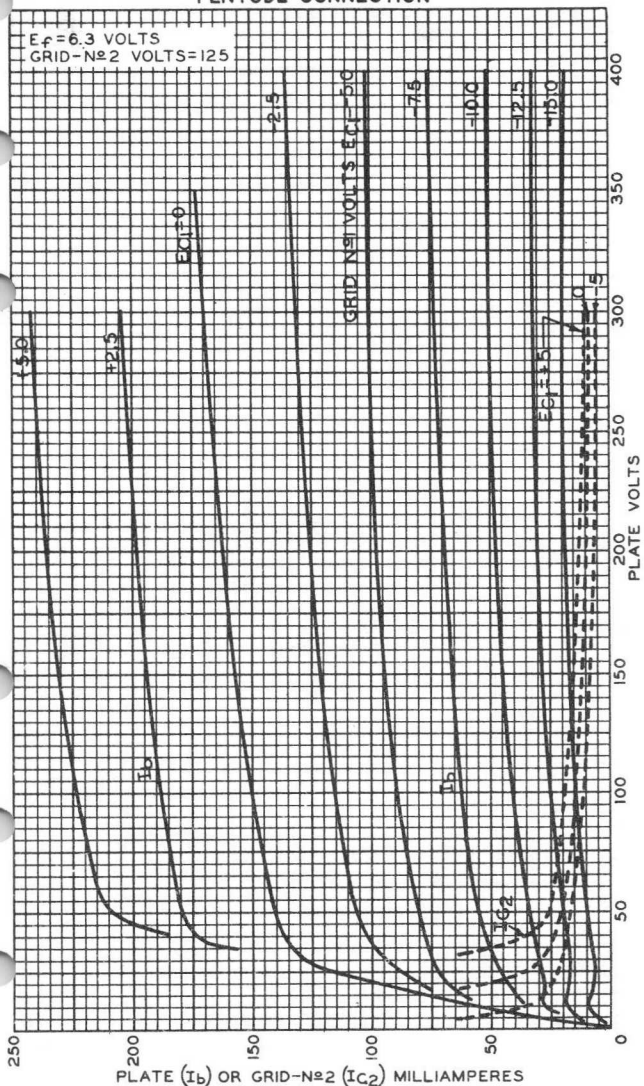

MAR. 20. 1953

TUBE DEPARTMENT

92CM-7942

RADIO CORPORATION OF AMERICA, HARRISON, NEW JERSEY

6W6-GT



6W6-GT

AVERAGE PLATE CHARACTERISTICS

TRIODE CONNECTION

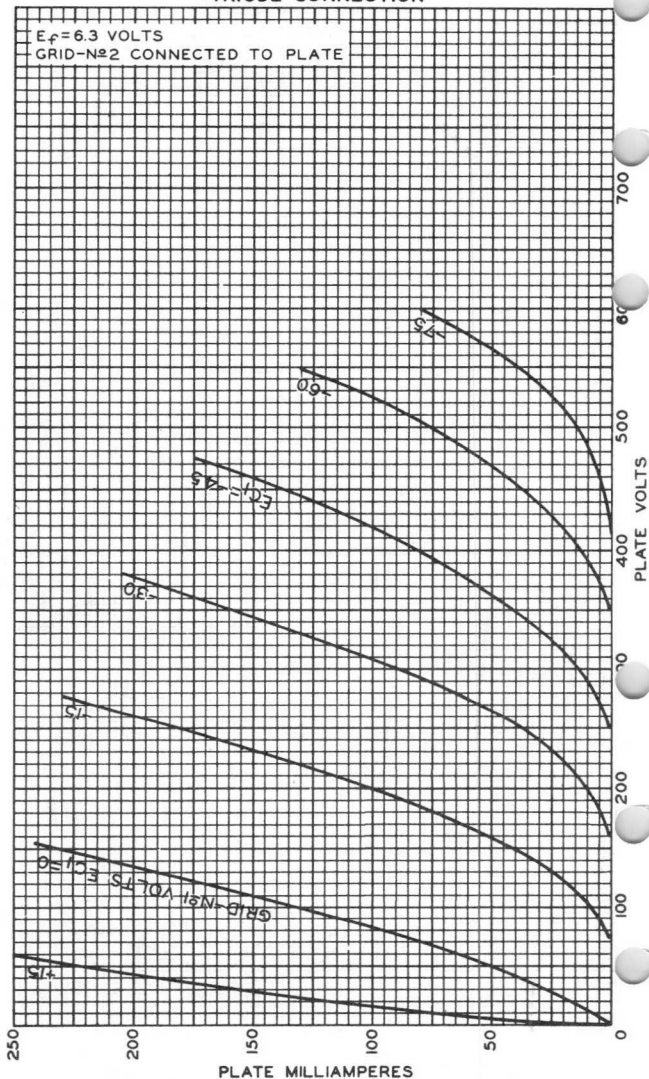

MAR. 11, 1953

TUBE DEPARTMENT
RADIO CORPORATION OF AMERICA, HARRISON, NEW JERSEY

92CM-7943



6X4

6X4

FULL-WAVE VACUUM RECTIFIER

MINIATURE TYPE

GENERAL DATA

Electrical:

Heater, for Unipotential Cathode:

Voltage	6.3	ac or dc volts
Current	0.6	amp

Mechanical:

Mounting Position	Any
Maximum Overall Length	2-5/8"
Maximum Seated Length	2-3/8"
Length from Base Seat to Bulb Top (Excluding tip)	2" ± 3/32"
Maximum Diameter	3/4"
Bulb	T-5-1/2
Base	Small-Button Miniature 7-Pin (JETEC No. E7-1)
Basing Designation for BOTTOM VIEW	7CF

Pin 1 - Plate No.2
 Pin 2 - No Connection
 Pin 3 - Heater
 Pin 4 - Heater

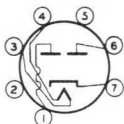

Pin 5 - No Connection
 Pin 6 - Plate No.1
 Pin 7 - Cathode

RECTIFIER SERVICE

Maximum Ratings, Design-Center Values:

PEAK INVERSE PLATE VOLTAGE	1250 max. volts
PEAK PLATE CURRENT PER PLATE	210 max. ma
AC PLATE SUPPLY VOLTAGE (RMS) PER PLATE	See Rating Chart I
DC OUTPUT CURRENT PER PLATE	See Rating Chart I

HOT-SWITCHING CURRENT:

If hot-switching is regularly required in operation, the use of choke-input circuits is recommended. Such circuits limit the hot-switching current to a value no higher than that of the peak plate current. When capacitor-input circuits are used, a maximum peak current value per plate of 1 ampere during the initial cycles of the hot-switching transient should not be exceeded.

PEAK HEATER-CATHODE VOLTAGE:

Heater negative with respect to cathode	450 max. volts
Heater positive with respect to cathode	450 max. volts

Typical Operation as Full-Wave Rectifier

with Capacitor-Input to Filter:

AC Plate-to-Plate Supply Voltage (RMS)	650	volts
Filter Input Capacitor	10	μf
Effective Plate-Supply Impedance per Plate*	520	ohms

* Higher values of capacitance than indicated may be used but the effective plate-supply impedance should be increased to prevent exceeding the maximum rating for peak plate current.

← Indicates a change

6X4



6X4

FULL-WAVE VACUUM RECTIFIER

DC Output Voltage at Input to

Filter (Approx.):

At half-load current of 35 ma. 360 volts

At full-load current of 70 ma. 300 volts

Voltage Regulation (Approx.):

Half-load to full-load current 60 volts

→ Typical Operation as Full-Wave Rectifier

with Choke-Input to Filter:

AC Plate-to-Plate Supply Voltage (RMS) . . . 900 volts

Minimum Filter Input Choke 10 henries

DC Output Voltage at Input to

Filter (Approx.):

At half-load current of 35 ma. 385 volts

At full-load current of 70 ma. 370 volts

Voltage Regulation (Approx.):

Half-load to full-load current 15 volts

AVERAGE PLATE CHARACTERISTIC

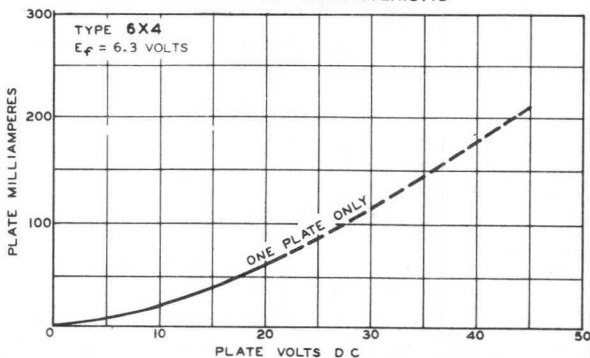

92CM-6106TI

RATING CHARTS AND OPERATION CHARACTERISTICS

Rating Chart I represents graphically the relationships between maximum ac voltage input and maximum dc output current derived from the fundamental ratings for conditions of capacitor-input and choke-input filters. This graphical presentation gives the equipment designer considerable latitude in choice of operating conditions.

Rating Chart II represents graphically the relationship between maximum rectification efficiency and maximum dc output current per plate for conditions of capacitor input to filter.

→ Indicates a change

OCT. 1, 1953

TUBE DEPARTMENT
RADIO CORPORATION OF AMERICA, HARRISON, NEW JERSEY

DATA 1



6X4

6X4

FULL-WAVE VACUUM RECTIFIER

Rating Chart III represents graphically the relationships between minimum plate-supply resistance per plate and maximum ac plate-supply voltage per plate under no-load conditions for conditions of capacitor input to filter when occasional hot-switching is employed.

The *Operation Characteristics for Full-Wave Circuit with Capacitor-Input Filter* show not only the typical operating curves for such a circuit, but also show by means of boundary-lines "DEA" the limiting current and voltage relationships presented on *Rating Chart I*.

The *Operation Characteristics for Full-Wave Circuit with Choke-Input Filter* show the typical operating curves for such a circuit. They not only show by means of boundary line "ABC" the limiting current and voltage relationships presented on *Rating Chart I*, but also give information as to the effect on regulation of various sizes of chokes. The solid-line curves show the dc voltage outputs which would be obtained if the filter chokes had infinite inductance. The long-dash lines radiating from the zero position are boundary lines for various sizes of chokes as indicated. The intersection of one of these lines with a solid-line curve indicates the point on the curve at which the choke no longer behaves as though it had infinite inductance. To the left of the choke boundary line, the regulation curves depart from the solid-line curves as shown by the representative short-dash regulation curves.

6X4



6X4

RATING CHART I

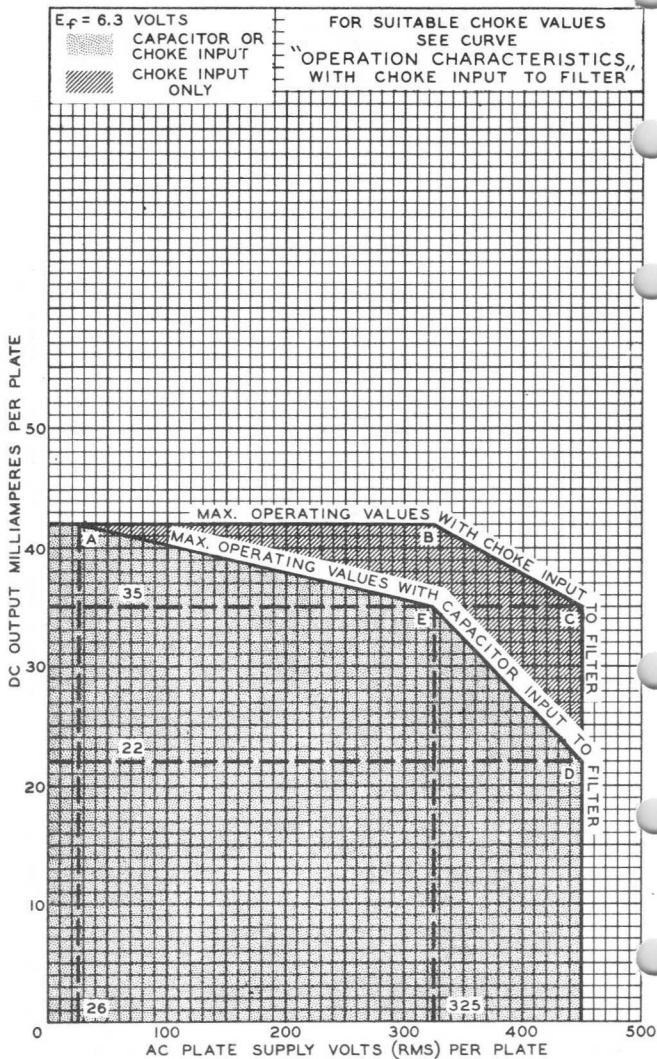

JUNE 29, 1953

TUBE DEPARTMENT
RADIO CORPORATION OF AMERICA, HARRISON, NEW JERSEY

92CM-8025



6X4

RATING CHART II CAPACITOR INPUT TO FILTER

$E_f = 6.3$ VOLTS

MAX. PEAK PLATE CURRENT PER PLATE = 210 MA.

$$\text{RECTIFICATION EFFICIENCY} = \frac{\bar{E}}{\sqrt{2} E_s}$$

WHERE \bar{E} = DC OUTPUT VOLTS AT INPUT TO FILTER

E_s = AC PLATE SUPPLY VOLTS (RMS) PER PLATE

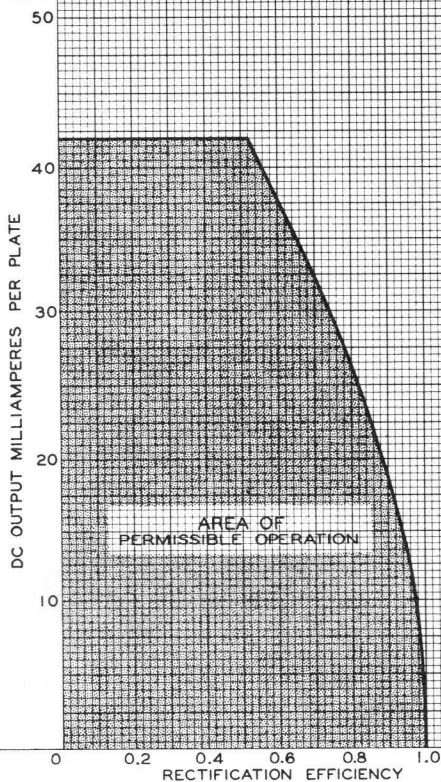

JUNE 26, 1953

TUBE DEPARTMENT
RADIO CORPORATION OF AMERICA, HARRISON, NEW JERSEY

92CM-8024

6X4



6X4

RATING CHART III CAPACITOR INPUT TO FILTER

$E_f = 6.3$ VOLTS MAX. HOT SWITCHING CUR. = 1 AMP.

PLATE-SUPPLY RESISTANCE PER PLATE = $R_{SEC} + N^2 R_{PRI} + R_A$

WHERE R_{SEC} = DC RESISTANCE OF TRANSFORMER
SECONDARY PER SECTION

R_{PRI} = DC RESISTANCE OF TRANSFORMER
PRIMARY

R_A = DC RESISTANCE OF ADDED SERIES
RESISTANCE PER PLATE

N = TRANSFORMER VOLTAGE STEP-UP
RATIO PER SECTION

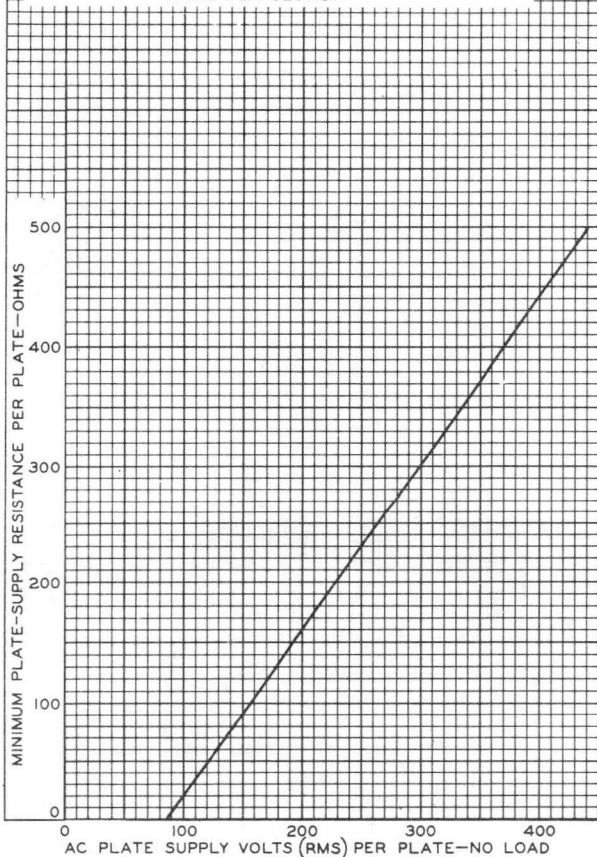

JUNE 29, 1953

TUBE DEPARTMENT

92CM-8026

RADIO CORPORATION OF AMERICA, HARRISON, NEW JERSEY



6X4

6X4

OPERATION CHARACTERISTICS FULL-WAVE CIRCUIT, CAPACITOR INPUT TO FILTER

$E_f = 6.3$ VOLTS
CAPACITOR (C) INPUT TO FILTER: $C = 10\mu F$
TOTAL EFFECTIVE PLATE-SUPPLY RESISTANCE
PER PLATE { 520 OHMS FOR CURVES 1-5
 { 400 OHMS FOR CURVES 6-8
SUPPLY FREQUENCY = 60 CPS

CURRENT-AND VOLTAGE-
BOUNDARY LINE 'DEA' IS
THE SAME AS SHOWN ON
RATING CHART I

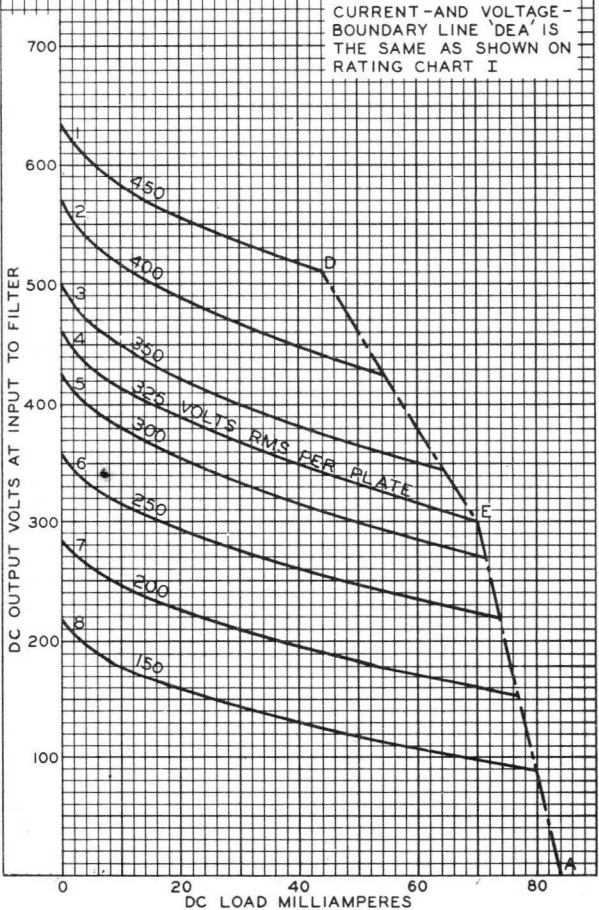

JULY 3, 1953

TUBE DEPARTMENT
RADIO CORPORATION OF AMERICA, HARRISON, NEW JERSEY

92CM-8031



6X5
6X5-GT/G

6X5, 6X5-GT/G

FULL-WAVE HIGH-VACUUM RECTIFIER

Heater Voltage	Coated Unipotential Cathode		a-c or d-c volts
Current	6.3		amp.
	0.6		
	6X5	6X5-GT/G	
Maximum Overall Length	3-1/4"	3-5/16"	
Maximum Seated Height	2-11/16"	2-3/4"	
Maximum Diameter	1-5/16"	1-5/16"	
Bulb	Metal Shell, MT-8	Intermed. Sh.	
Base	Small Wafer	Octal 6-Pin	
Basing Designation	6S	G-6S	
Pin 1	{ 6X5, Shell	Pin 5 - Plate #1	
Pin 2	{ 6X5-GT/G, No Con.	Pin 7 - Heater	
Pin 3	- Heater	Pin 8 - Cathode	
Pin 3 - Plate #2			
Mounting Position		{ 6X5: Vertical	
		{ 6X5-GT/G: Any	

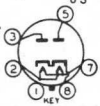

BOTTOM VIEW

Maximum Ratings Are Design-Center Values

FULL-WAVE RECTIFIER

Peak Inverse Plate Voltage	1250 max. volts
Peak Plate Current per Plate	210 max. ma.
D-C Output Current:	
With condenser input to filter	70 max. ma.
With choke input to filter	70 [•] max. ma.
D-C Heater-Cathode Potential	450 max. volts

Typical Operation:

	Condenser- Input Filter	Choke- Input Filter
A-C Plate-to-Plate Supply Voltage (RMS)	650	900 volts
Filter Input Condenser	4	- μ f
Min. Total Effect. Plate-Supply Imped. per Plate	150	- ohms
Filter Input Choke	-	8 henries
D-C Output Current	70	70 ma.
D-C Voltage (At input to filter):*		
At half-load current (35 ma.)	405	385 volts
At full-load current (70 ma.)	370	380 volts
Difference (Voltage Regulation)	35	5 volts
Percentage Regulation	8.5	1.3 %

◇ Horizontal operation permitted if pins 3 & 5 are in a horizontal plane.

• For choke not less than 8 henries.

* Approximate values.

AVERAGE PLATE CHARACTERISTIC

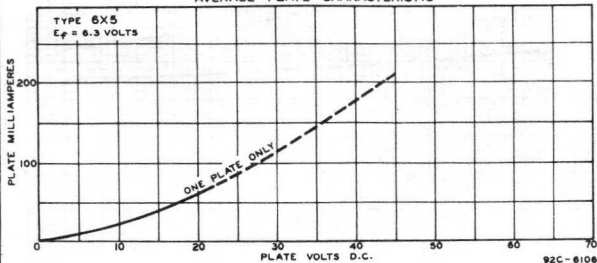

Mar. 20, 1943

RCA VICTOR DIVISION
RADIO CORPORATION OF AMERICA, HARRISON, NEW JERSEY

DATA

6X5



6X5

OPERATION CHARACTERISTICS

 $E_f = 6.3$ VOLTS

- CHOKE (L) INPUT TO FILTER:
L = 8 HENRIES (MIN.)
- CONDENSER (C) INPUT TO FILTER:
C = $4\mu\text{f}$; TOTAL EFFECT. PLATE-SUPPLY
IMPEDANCE PER PLATE = 150 OHMS

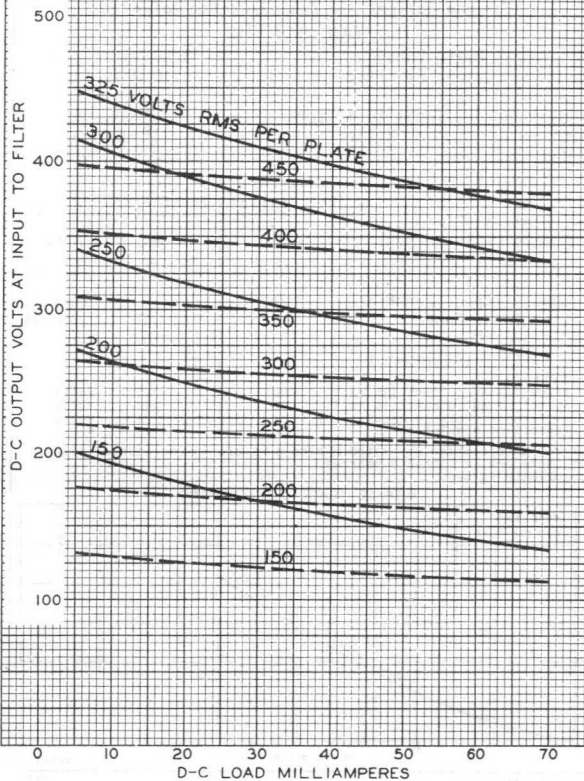

NOV. 15, 1939

RCA VICTOR DIVISION
RADIO CORPORATION OF AMERICA, HARRISON, NEW JERSEY

92C-4576R1

Medium-Mu Triode— Sharp-Cutoff Pentode

9-PIN MINIATURE TYPE

GENERAL DATA

Electrical:

Heater, for Unipotential Cathode:

Voltage (AC or DC)	6.3 ± 10%	volts
Current at 6.3 volts.	0.45	amp

Direct Interelectrode Capacitances:

	<i>Without External Shield</i>	<i>With External Shield[▲]</i>	
<i>Triode Unit:</i>			
Grid to plate	1.5	1.5	μf
Grid to cathode and heater.	2	2.4	μf
Plate to cathode and heater.	0.5	1	μf
<i>Pentode Unit:</i>			
Grid No.1 to plate.	0.09 max.	0.06 max.	μf
Grid No.1 to cathode, grid No.3, grid No.2, and heater.	4.6	4.8	μf
Plate to cathode, grid No.3, grid No.2, and heater.	0.9	1.6	μf
Pentode grid No.1 to triode plate.	0.05 max.	0.04 max.	μf
Pentode plate to triode plate.	0.05 max.	0.008 max.	μf
Heater to cathode	6.5	6.5 [●]	μf

Characteristics, Class A₁ Amplifier:

	<i>Triode Unit</i>	<i>Pentode Unit</i>		
Plate Voltage	125	100	125	volts
Grid No.3	—	<i>Connected to cathode at socket</i>		
Grid-No.2 Voltage	—	70	125	volts
Grid-No.1 Voltage	-1	—	-1	volt
Amplification Factor.	40	—	—	
Plate Resistance (Approx.)	6000	—	300000	ohms
Transconductance.	6500	5700	5500	μmhos
Plate Current	12	—	9	ma
Grid-No.2 Current	—	—	2.2	ma
Grid-No.1 Voltage (Approx.) for plate $\mu a = 20$	-7	—	-6.5	volts

▲ Indicates a change.



6X8

Mechanical:

Operating Position. Any
 Maximum Overall Length. 2-3/16"
 Maximum Seated Length. 1-15/16"
 Length, Base Seat to Bulb Top (Excluding tip) . 1-9/16" ± 3/32"
 → Diameter. 0.750" to 0.875"
 Dimensional Outline See *General Section*
 Bulb. T6-1/2
 Base. Small-Button Noval 9-Pin (JEDEC No.E9-1)
 Basing Designation for BOTTOM VIEW. 9AK

Pin 1 - Pentode
 Grid No.3
 Pin 2 - Triode Grid
 Pin 3 - Triode Plate
 Pin 4 - Heater
 Pin 5 - Heater

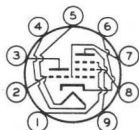

Pin 6 - Cathode
 Pin 7 - Pentode
 Grid No.1
 Pin 8 - Pentode
 Grid No.2
 Pin 9 - Pentode Plate

AMPLIFIER — Class A₁

Maximum Ratings, Design-Maximum Values:

	Triode Unit	Pentode Unit
PLATE VOLTAGE	275 max.	275 max. volts
GRID No.3 (SUPPRESSOR GRID)	-	Connect to cathode at socket
GRID-No.2 (SCREEN-GRID) SUPPLY VOLTAGE.	-	275 max. volts
GRID-No.2 VOLTAGE	-	See Grid-No.2 Input
<i>Rating Chart at front of Receiving Tube Section</i>		
GRID-No.1 (CONTROL-GRID) VOLTAGE:		
Positive-bias value	0 max.	0 max. volts
GRID-No.2 INPUT:		
For grid-No.2 voltages up to 137.5 volts	-	0.45 max. watt
For grid-No.2 voltages between 137.5 and 275 volts	-	See Grid-No.2 Input
<i>Rating Chart at front of Receiving Tube Section</i>		
PLATE DISSIPATION	1.7 max.	2.3 max. watts
PEAK HEATER-CATHODE VOLTAGE:		
Heater negative with respect to cathode.	200 max.	200 max. volts
Heater positive with respect to cathode.	200* max.	200* max. volts

- ▲ With external shield JEDEC No.315 connected to cathode except as noted.
- With external shield JEDEC No.315 connected to pentode plate.
- * The dc component must not exceed 100 volts.

→ Indicates a change.



AVERAGE CHARACTERISTICS Triode Unit

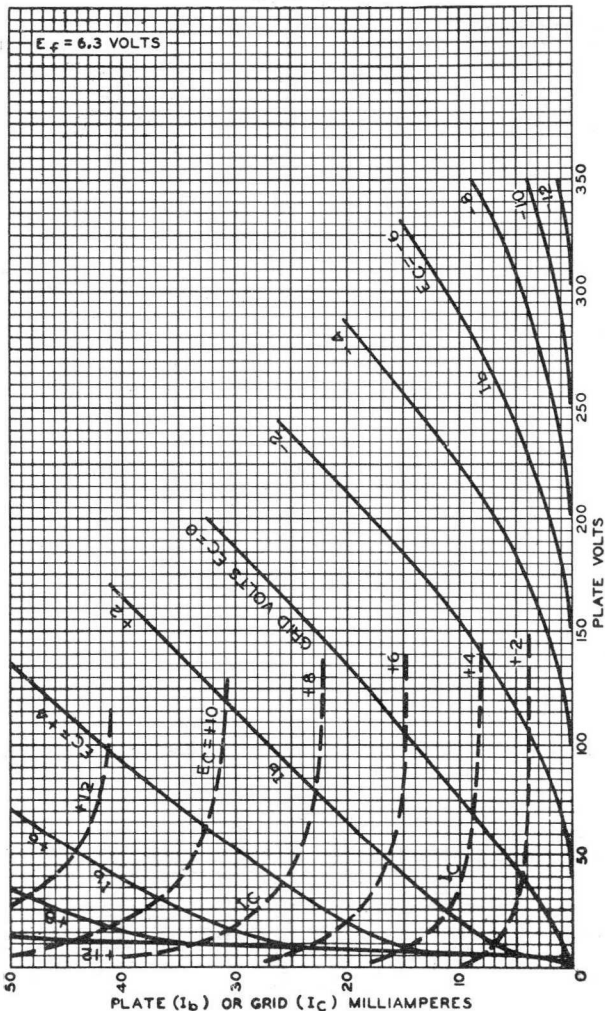

92CM-7531



6X8

AVERAGE CHARACTERISTICS Triode Unit

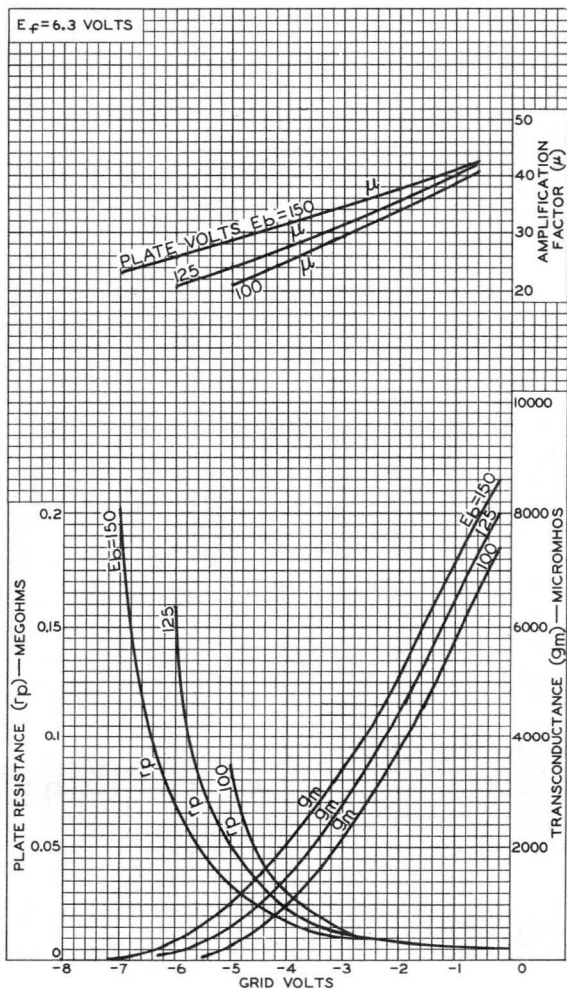

92CM-10809



AVERAGE CHARACTERISTICS

Pentode Unit

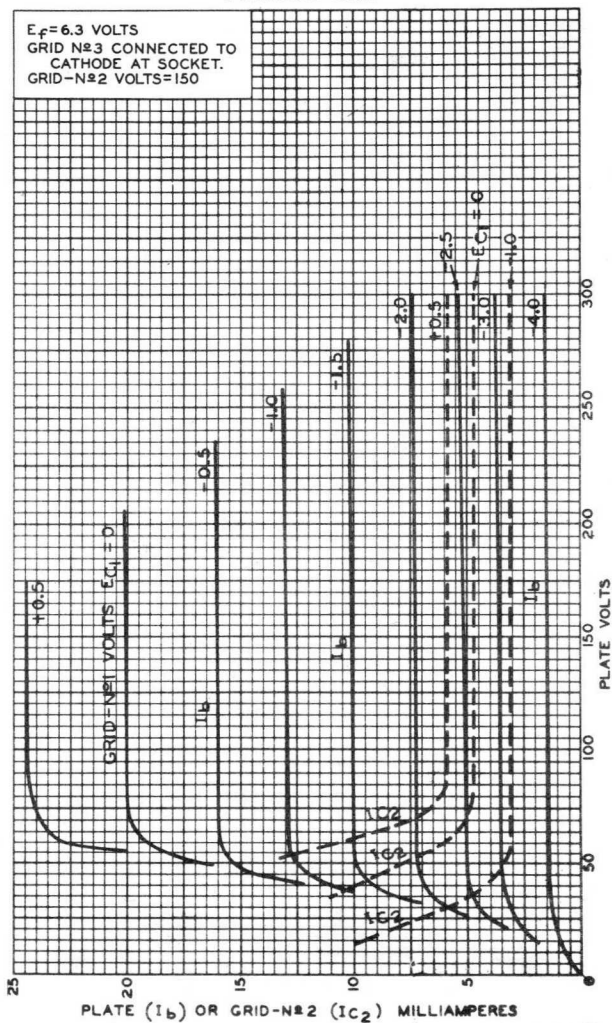

92CM-7532R1



6X8

AVERAGE CHARACTERISTICS Pentode Unit

$E_f = 6.3$ VOLTS
PLATE VOLTS = 125
GRID No 3 CONNECTED TO
CATHODE AT SOCKET.
GRID-No 2 VOLTS = 125

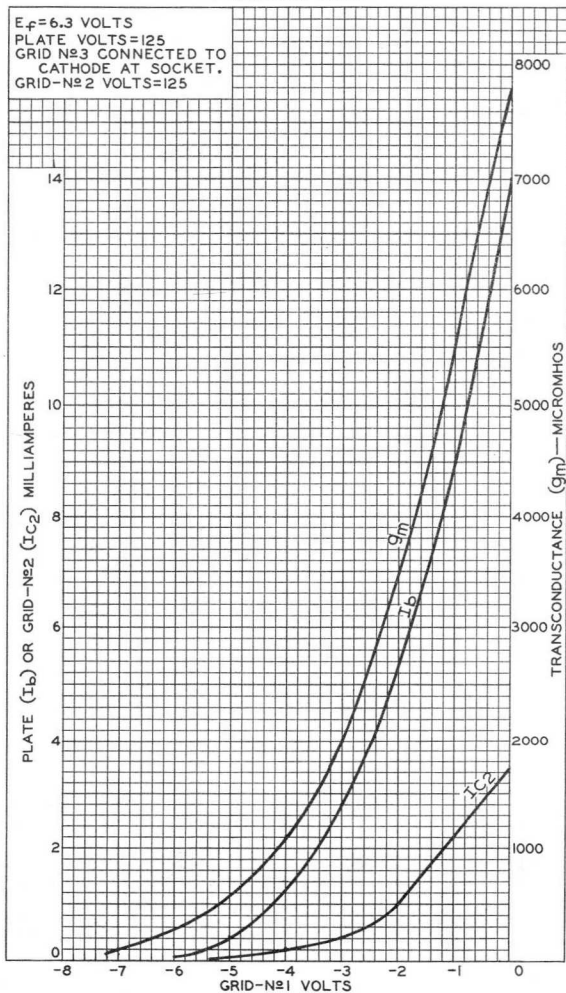

92CM-10810





6Y6-GA

6Y6-GA BEAM POWER TUBE

GENERAL DATA

Electrical:

Heater, for Unipotential Cathode:		
Voltage (AC or DC)	6.3	volts
Current	1.25	amp
Direct Interelectrode Capacitances (Approx.): ^o		
Grid No.1 to plate	0.66	μ f
Grid No.1 to cathode & grid No.3, grid No.2, and heater.	12	μ f
Plate to cathode & grid No.3, grid No.2, and heater.	7.5	μ f

Mechanical:

Operating Position.	Any
Maximum Overall Length.	3-7/8"
Maximum Seated Length	3-5/16"
Diameter.	1.438" to 1.562"
Bulb.	T12
Base.	Medium-Shell Octal 7-Pin (JEDEC Group 1, No.B7-12), or Short Medium-Shell Octal 7-Pin with External Barriers, Style B (JEDEC Group 1, No.B7-119)
Basing Designation for BOTTOM VIEW.7S

- Pin 1 - No Connection
- Pin 2 - Heater
- Pin 3 - Plate
- Pin 4 - Grid No.2

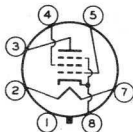

- Pin 5 - Grid No.1
- Pin 7 - Heater
- Pin 8 - Cathode,
Grid No.3

AMPLIFIER — Class A₁

Maximum Ratings, Design-Center Values:

PLATE VOLTAGE.	200 max.	volts
GRID-No.2 (SCREEN-GRID) SUPPLY VOLTAGE	200 max.	volts
GRID-No.2 VOLTAGE.	<i>See Grid-No.2 Input Rating Chart at front of Receiving Tube Section</i>	
GRID-No.2 INPUT:		
For grid-No.2 voltages up to 100 volts.	1.75 max.	watts
For grid-No.2 voltages between 100 and 200 volts.	<i>See Grid-No.2 Input Rating Chart at front of Receiving Tube Section</i>	
PLATE DISSIPATION.	12.5 max.	watts
PEAK HEATER-CATHODE VOLTAGE:		
Heater negative with respect to cathode.	180 max.	volts
Heater positive with respect to cathode.	180 max.	volts

^o without external shield.

6Y6-GA



6Y6-GA

BEAM POWER TUBE

Maximum Circuit Values:

Grid-No.1-Circuit Resistance:

For fixed-bias operation.	1 max.	megohm
For cathode-bias operation.	0.5 max.	megohm

Typical Operation and Characteristics:

Plate Voltage	135	200	volts
Grid-No.2 Voltage	135	135	volts
Grid-No.1 Voltage	-13.5	-14	volts
Peak AF Grid-No.1 Voltage	13.5	14	volts
Zero-Signal Plate Current	58	61	ma
Max.-Signal Plate Current	60	66	ma
Zero-Signal Grid-No.2 Current	3.5	2.2	ma
Max.-Signal Grid-No.2 Current	11.5	9	ma
Plate Resistance (Approx.)	9300	18300	ohms
Transconductance.	7000	7100	μmhos
Load Resistance	2000	2600	ohms
Total Harmonic Distortion	10	10	%
Max.-Signal Power Output.	3.6	6	watts

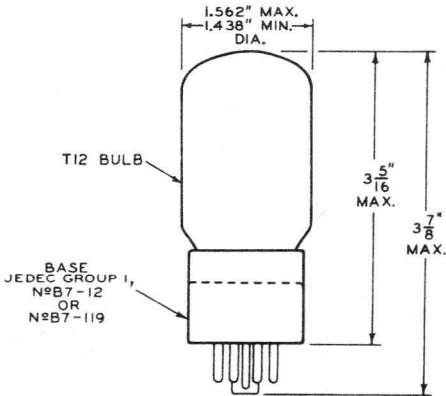

92CS-10248

Pentode—Beam Power Tube

DUODECAR TYPE

For Combined Limiter, Discriminator, and Audio Power
Output Applications in FM Radio and TV Receivers

ELECTRICAL CHARACTERISTICS

Bogey Values

Heater Voltage	E_h	6.3	V
Heater Current	I_h	0.950	A

Direct Interelectrode Capacitances

Without external shield

Pentode Unit:

G_{1p} to G_{3p}	C_{g1-g3}	0.009	pF
G_{1p} to ($K_p + I_S$, P_p , G_{3p} , G_{2p} , H)	C_{g1-all}	4.4	pF
G_{3p} to ($K_p + I_S$, P_p , G_{2p} , G_{1p} , H)	C_{g3-all}	3.2	pF

Beam Power Unit:

G_{1B} to P_B	C_{g1-p}	0.22	pF
Input: G_{1B} to ($K_B + G_{3B}$, G_{2B} , H)	C_i	11	pF
Output: P_B to ($K_B + G_{3B}$, G_{2B} , H)	C_o	7.5	pF

Pentode Unit

For the following characteristics, see Conditions

Transconductance, Grid No.1 to Plate	g_m	- -	360	μ mo
Transconductance, Grid No.3 to Plate	$g_m(g_{3-p})$	- -	700	μ mo
DC Plate Current	I_b	- 5	-	mA
DC Grid-No.2 Current	I_{c2}	4.5	-	mA
Cutoff DC Grid-No.1 Voltage for $I_b = 20 \mu A$	$E_{c1(co)}$	- -	-4	V
Cutoff DC Grid-No.3 Voltage for $I_b = 20 \mu A$	$E_{c3(co)}$	- -	-4	V

Conditions

Heater Voltage	E_h	Bogey value			V
DC Plate Voltage	E_b	135	135	135	V
DC Grid-No.3 Voltage	E_{c3}	4	4	0	V
DC Grid-No.2 Supply Voltage	E_{cc2}	-	280	280	V
DC Grid-No.2 Voltage	E_{c2}	75	-	-	V
DC Grid-No.1 Voltage	E_{c1}	0	0	0	V
Grid-No.2 Resistor	R_{g2}	-	33	33	k Ω

Beam Power Unit

For the following characteristics, see Conditions

Plate Resistance (Approx.)	r_p	100	k Ω
Transconductance	g_m	6500	μ mo
DC Plate Current	I_b	35	mA
DC Grid-No.2 Current	I_{c2}	3	mA

Conditions

Heater Voltage	E_h	Bogey value		V
DC Plate Voltage	E_b	250		V
DC Grid-No.2 Voltage	E_{c2}	250		V
DC Grid-No.1 Voltage	E_{c1}	-8		V



MECHANICAL CHARACTERISTICS

Operating Position	Any
Type of Cathodes	Coated Unipotential
Maximum Overall Length	2.375 in
Maximum Seated Length	2.000 in
Maximum Diameter	1.188 in
Dimensional Outline (JEDEC 9-58)	See General Section
Envelope	JEDEC T9
Base	Small-Button Duodecar 12-Pin (JEDEC E12-70)

TERMINAL DIAGRAM (Bottom View)

- Pin 1 - Heater
- Pin 2 - Beam Power Grid No.2
- Pin 3 - Beam Power Cathode,
Beam Power Grid No.3
- Pin 4 - Pentode Plate
- Pin 5 - Pentode Grid No.3
- Pin 6 - Pentode Grid No.2
- Pin 7 - Pentode Grid No.1
- Pin 8 - Pentode Cathode,
Internal Shields
- Pin 9 - Beam Power Plate
- Pin 10 - No Internal Connection
- Pin 11 - Beam Power Grid No.1
- Pin 12 - Heater

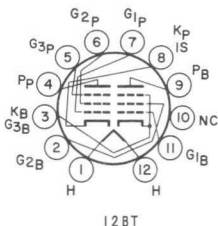

DESIGN-MAXIMUM RATINGS

Pentode Unit for FM and TV Limiter and Discriminator Service; Beam Power Unit for Audio Power Output Service

		Pentode Unit	Beam Power Unit	
DC Plate Supply Voltage. . .	E_{bb}	330	-	V
DC Plate Voltage	E_b	-	275	V
DC Grid-No.2 (Accelerator- Grid) Supply Voltage. . .	E_{cc2}	330	-	V
DC Grid-No.2 (Screen-Grid) Voltage	E_{c2}	-	275	V
Peak Positive-Pulse Grid- No.1 (Limiter-Grid) Voltage	e_{c1m}	60	-	V
Heater-Cathode Voltage:				
Peak	e_{hkm}	±200	±200	V
DC	E_{hk}	100	100	V
Heater Voltage (AC or DC). .	E_h	← 5.7 to 6.9 →		V
Average Cathode Current. . .	$I_{k(av)}$	13	-	mA
Grid-No.2 Input.	P_{g2}	-	2	W
Plate Dissipation.	P_b	-	10	W

MAXIMUM CIRCUIT VALUES

Beam Power Unit

Grid-No.1-Circuit Resistance:	$R_{g1(ckt)}$	
For fixed-bias operation	-	0.25 MΩ
For cathode-bias operation	-	0.5 MΩ



TYPICAL OPERATION

Beam Power Unit

		Bogey value	
Heater Voltage	E_h		V
DC Plate Voltage	E_b	250	V
DC Grid-No.2 Voltage	E_{c1}	250	V
DC Grid-No.1 Voltage	E_{c2}	-8	V
Peak AF Grid-No.1 Voltage	e_{c1m}	8	V
Plate Resistance (Approx.)	r_p	100	$k\Omega$
Transconductance	g_m	6500	μmho
Zero-Signal Plate Current	I_b	35	mA
Maximum-Signal Plate Current	I_b	39	mA
Zero-Signal Grid-No.2 Current	I_{c2}	3	mA
Maximum-Signal Grid-No.2 Current	I_{c2}	13	mA
Load Resistance	R_L	5000	Ω
Total Harmonic Distortion		8.5	%
Maximum-Signal Power Output	P_o	4.2	W





7AU7

Medium-Mu Twin Triode

The 7AU7 is the same as the 12AU7A except for the following items:

Heater Characteristics and Ratings

	Parallel	Series
Heater-section arrangement	3.5 ^a	7.0 ± 0.7 V
Voltage (AC or DC)	0.600 ± 0.040	0.300 ^b A
Current		- s
Warm-up time (Average)		

^a At 0.600 ampere.

^b At 7.0 volts.

7EY6

Beam Power Tube

The 7EY6 is the same as the 6EY6 except for the following items:

Heater Characteristics and Ratings

Current	0.600 ± 0.040	A
Voltage (AC or DC) at 0.600 A	7.2	V
Warm-up time (Average)		s

7KY6

Sharp-Cutoff-Pentode

The 7KY6 is the same as the 6KY6 except for the following items:

Heater Characteristics and Ratings

Current	0.450 ± 0.030	A
Voltage (AC or DC) at 0.450 A	7.3	V
Warm-up time (Average)		s





Sharp-Cutoff Pentode

9-PIN MINIATURE TYPE

FRAME-GRID CONSTRUCTION

DARK HEATER

For Video-Output Service in Color-TV Receivers

ELECTRICAL CHARACTERISTICS

Bogey Values^a

Heater Voltage (AC or DC)	E_h	7.3	V
Heater Current	I_h	0.450	A
Heater Warm-up Time		11	s
Direct Interelectrode Capacitances			
Without external shield			
Grid No.1 to plate	C_{g1-p}	0.16 max	pF
Input: G1 to (K, G3 + IS, G2, H)	C_{c1}	13.0	pF
Output: P to (K, G3 + IS, G2, H)	C_o	6.0	pF

For the following characteristics, see Conditions

Plate Resistance (Approx.)	r_p	45	k Ω
Transconductance	g_m	24000	μ mho
DC Plate Current	I_b	25	mA
DC Grid-No.2 Current	I_{c2}	3.6	mA
Cutoff DC Grid-No.1 Voltage	$E_{c1}(co)$	-5.2	V

Conditions

Heater Voltage	E_h	7.3	V
DC Plate Supply Voltage	E_{bb}	250	V
Grid No.3	-	Connected to cathode at socket	
DC Grid-No.2 Supply Voltage	E_{cc2}	115	V
DC Grid-No.1 Supply Voltage	E_{cc1}	0	V
Cathode Resistor	R_k	75	Ω

MECHANICAL CHARACTERISTICS

Operating Position	Any
Type of Cathode	Coated Unipotential
Maximum Overall Length	2.625 in
Maximum Seated Length	2.375 in
Length, Base Seat to Bulb Top	1.906 to 2.094 in
Excluding tip	
Maximum Diameter	0.875 in
Dimensional Outline (JEDEC 6-3)	See <i>General Section</i>
Envelope	JEDEC T6-1/2
Base	Small-Button Noval 9-Pin (JEDEC E9-1)

TERMINAL DIAGRAM (Bottom View)

- Pin 1 - Cathode
- Pin 2 - Grid No.1
- Pin 3 - Grid No.3 Internal Shield
- Pin 4 - Heater
- Pin 5 - Heater
- Pin 6 - No Internal Connection
- Pin 7 - Plate
- Pin 8 - Grid No.2
- Pin 9 - Same as Pin 3

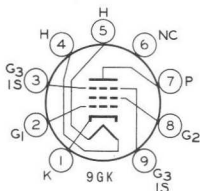

DESIGN-MAXIMUM RATINGS

For operation as a Class A₁ Amplifier Tube

Plate Voltage.	E_b	330	V
Grid-No.2 (Screen-Grid) Supply Voltage	E_{c2}	330	V
Grid No.2 Voltage.	E_{c2}	See <i>Grid-No.2</i>	

Input Rating Chart

at front of Receiving Tube Section

Grid-No.1 (Control-Grid) Voltage			
Positive-bias value.	E_{c1}	0	V

Heater-Cathode Voltage

Peak	e_{hkm}	±200	V
DC	E_{hk}	100	V
Heater Current	I_h	0.420 to 0.480	A

Grid-No.2 Input

For $E_{c2} \leq 165$ V.	-	1	W
For $E_{c2} \geq 165$ and ≤ 330 V.	-	See <i>Grid-No.2</i>	

Input Rating Chart

at front of Receiving Tube Section

Plate Dissipation.	P_b	9	W
----------------------------	-------	---	---

MAXIMUM CIRCUIT VALUES

Grid-No.1 Circuit Resistance	$R_{g1(ckt)}$		
For fixed-bias operation	-	0.1	MΩ
For cathode-bias operation	-	0.25	MΩ

^a Unless otherwise specified.

Typical Characteristics

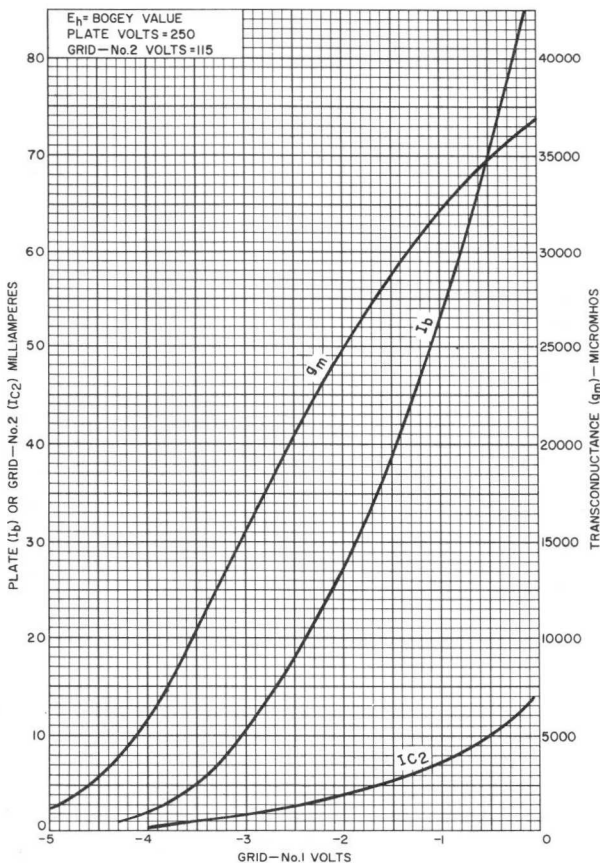

92CM-14533



Typical Characteristics

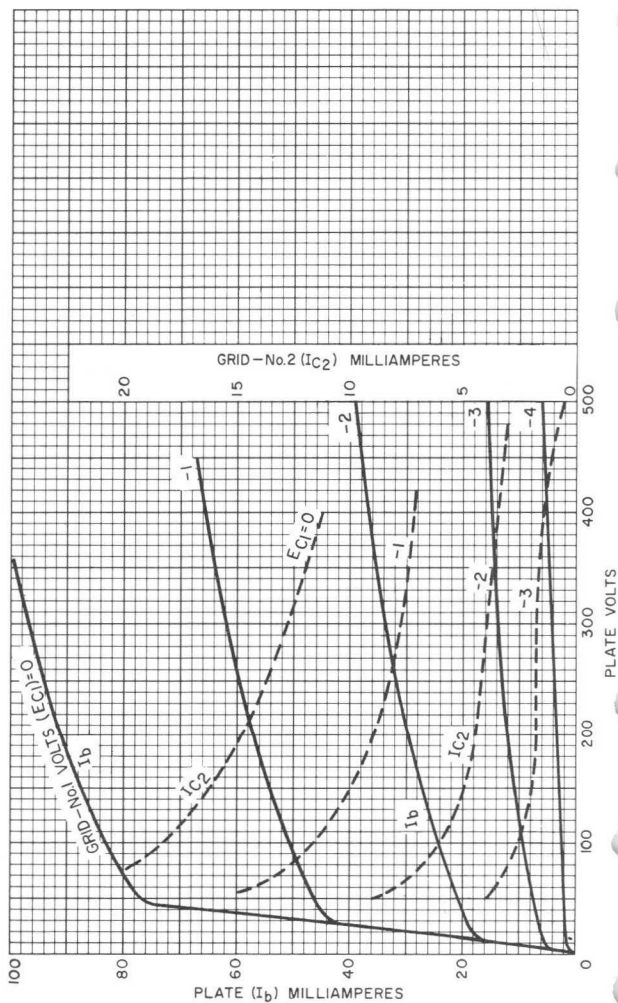

92CM-14532



Medium-Mu Triode— Sharp-Cutoff Pentode

9-PIN MINIATURE TYPE

GENERAL DATA

Electrical:

Heater Characteristics and Ratings:

Current	0.450 \pm 0.030	amp
Voltage (AC or DC) at heater amperes = 0.450	8.4	volts
Warm-up time (Average).	11	sec
Peak heater-cathode voltage (Each Unit):		
Heater negative with respect to cathode.	200 max.	volts
Heater positive with respect to cathode.	200 ^a max.	volts

Direct Interelectrode Capacitances:^b

Triode Unit:

Grid to plate	2.2	pf
Grid to cathode and heater.	2.6	pf
Plate to cathode and heater	0.34	pf

Pentode Unit:

Grid No.1 to plate.	0.044	pf
Grid No.1 to cathode & internal shield & grid No.3, grid No.2, and heater.	7.5	pf
Plate to cathode & internal shield & grid No.3, grid No.2, and heater.	2.4	pf
Triode grid to pentode plate.	0.022 max.	pf
Pentode grid No.1 to triode plate	0.006 max.	pf
Pentode plate to triode plate	0.12 max.	pf

Characteristics, Class A₁ Amplifier:

	Triode Unit	Pentode Unit.	
Plate Supply Voltage:	150	200	volts
Grid-No.2 Supply Voltage.	—	125	volts
Cathode Resistor.	150	82	ohms
Amplification Factor.	40	—	
Plate Resistance (Approx.).	8200	150000	ohms
Transconductance.	4900	7000	μ mhos
Plate Current	9	15	ma
Grid-No.2 Current	—	3.4	ma
Grid-No.1 Voltage (Approx.) for plate μ a = 100.	-6.5	8	volts

Mechanical:

Operating Position.	Any
Type of Cathodes.	Coated Unipotential



8AU8

Maximum Overall Length 2-5/8"
 Maximum Seated Length 2-3/8"
 Length; Base Seat to Bulb Top (Excluding tip) . . . 2" \pm 3/32"
 Diameter 0.750" to 0.875"
 Dimensional Outline See *General Section*
 Bulb T6-1/2
 Base Small-Button Noval 9-Pin (JEDEC No. E9-1)
 Basing Designation for BOTTOM VIEW 9DX

Pin 1 - Triode
 Cathode
 Pin 2 - Triode
 Grid
 Pin 3 - Triode
 Plate
 Pin 4 - Heater
 Pin 5 - Heater

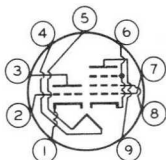

Pin 6 - Pentode
 Cathode,
 Grid No. 3,
 Internal
 Shield
 Pin 7 - Pentode
 Grid No. 1
 Pin 8 - Pentode
 Grid No. 2
 Pin 9 - Pentode
 Plate

AMPLIFIER — Class A₁

Maximum Ratings, Design-Center Values:

	Triode Unit	Pentode Unit	
PLATE VOLTAGE	300 max.	300 max.	volts
GRID-No. 2 (SCREEN-GRID) SUPPLY VOLTAGE	-	300 max.	volts
GRID-No. 2 VOLTAGE	-	See <i>Grid-No. 2 Input Rating Chart</i> at front of Receiving Tube Section	
GRID-No. 1 (CONTROL-GRID) VOLTAGE:			
Positive-bias value	0 max.	0 max.	volts
GRID-No. 2 INPUT:			
For grid-No. 2 voltages up to 150 volts	-	1 max.	watt
For grid-No. 2 voltages be- tween 150 and 300 volts	-	See <i>Grid-No. 2 Input Rating Chart</i> at front of Receiving Tube Section	
PLATE DISSIPATION	2.5 max.	3 max.	watts

Maximum Circuit Values:

	Triode Unit	Pentode Unit	
Grid-No. 1-Circuit Resistance:			
For fixed-bias operation	0.5 max.	0.25 max.	megohm
For cathode-bias operation	1 max.	1 max.	megohm

OPERATING CONSIDERATIONS

Because the *internal shield* is connected to the cathode and grid No. 3, the impedance in the cathode circuit should be kept as low as possible to minimize cross-coupling effects.

^a The dc component must not exceed 100 volts.
^b Without external shield.



8AW8A

High-Mu Triode— Sharp-Cutoff Pentode

9-PIN MINIATURE TYPE

The 8AW8A is the same as the 6AW8A except for the following items:

Heater Characteristics and Ratings:

Current	0.450 ± 0.030	amp
Voltage (AC or DC) at heater amperes = 0.450	8.4	volts
Warm-up time (Average).	11	sec

8B10

Twin Diode— Medium-Mu-Twin Triode

DUODECAR TYPE

The 8B10 is the same as the 6B10 except for the following items:

Heater Characteristics and Ratings:

Current	0.450 ± 0.030	amp
Voltage (AC or DC) at heater amperes = 0.450	8.5	volts
Warm-up time (Average).	11	sec

8BA8A

Medium-Mu Triode— Sharp-Cutoff Pentode

9-PIN MINIATURE TYPE

The 8BA8A is the same as the 6BA8A except for the following items:

Heater Characteristics and Ratings:

Current	0.450 ± 0.030	amp
Voltage (AC or DC) at heater amperes = 0.450	8.4	volts
Warm-up time (Average).	11	sec



8BH8

Medium-Mu Triode— Sharp-Cutoff Pentode

9-PIN MINIATURE TYPE

The 8BH8 is the same as the 6BH8 except for the following items:

Heater Characteristics and Ratings:

Current	0.450 ± 0.030	amp
Voltage (AC or DC) at heater amperes = 0.450	8.4	volts
Warm-up time (Average).	11	sec

8BN8

Twin Diode—High-Mu Triode

9-PIN MINIATURE TYPE

The 8BN8 is the same as the 6BN8 except for the following items:

Heater Characteristics and Ratings:

Current	0.450 ± 0.030	amp
Voltage (AC or DC) at heater amperes = 0.450	8.4	volts
Warm-up time (Average).	11	sec

8BQ5

Power Pentode

9-PIN MINIATURE TYPE

The 8BQ5 is the same as the 6BQ5 except for the following items:

Heater Characteristics and Ratings:

Current	0.600 ± 0.040	amp
Voltage (AC or DC) at heater amperes = 0.600	8.0	volts
Warm-up time (Average).	11	sec



8CG7

Medium-Mu Twin Triode

CONTROLLED HEATER WARM-UP TIME

The 8CG7 is the same as the 6CG7 except for the following items:

Heater Characteristics and Ratings:

Current.	0.450 ± 0.030	amp
Voltage (AC or DC) at 0.450 amp.	8.4	volts

8CM7

Medium-Mu Dual Triode

With Dissimilar Units

CONTROLLED HEATER WARM-UP TIME

The 8CM7 is the same as the 6CM7 except for the following items:

Heater Characteristics and Ratings:

Current.	0.450 ± 0.030	amp
Voltage (AC or DC) at 0.450 amp.	8.4	volts

8CN7

Twin Diode—High-Mu Triode

CONTROLLED HEATER WARM-UP TIME

The 8CN7 is the same as the 6CN7 except for the following items:

Heater Characteristics and Ratings:

Heater-section arrangement	Parallel	Series	Series	
Voltage (AC or DC).	4.2 ^a	8.4 ^b	8.4 ± 0.8	volts
Current.	0.450 ± 0.030	0.225 ± 0.010	0.225 ^c	amp

^a At 0.450 ampere.

^b At 0.225 ampere.

^c At 8.4 volts.



8CS7

Medium-Mu Dual Triode

With Dissimilar Units

CONTROLLED HEATER WARM-UP TIME

The 8CS7 is the same as the 6CS7 except for the following items:

Heater Characteristics and Ratings:

Current.	0.450 ± 0.030	amp
Voltage (AC or DC) at 0.450 amp.	8.4	volts

8CW5

Beam Power Tube

The 8CW5 is the same as the 6CW5 except for the following items:

Heater Characteristics and Ratings:

Current.	0.600 ± 0.040	amp
Voltage (AC or DC) at 0.600 amp.	8.0	volts

8CX8

Medium-Mu Triode— Sharp-Cutoff Pentode

The 8CX8 is the same as the 6CX8 except for the following items:

Heater Characteristics and Ratings:

Current.	0.600 ± 0.040	amp
Voltage (AC or DC) at 0.600 amp.	8.0	volts
Warm-up time (Average)	11	sec

8EB8

High-Mu Triode—Sharp-Cutoff Pentode

The 8EB8 is the same as the 6EB8 except for the following items:

Heater Characteristics and Ratings:

Current.	0.600 ± 0.040	amp
Voltage (AC or DC) at 0.600 amp.	8.0	volts
Warm-up time (Average)	11	sec



Beam Power Tube

9-PIN MINIATURE TYPE

With Heater Having Controlled Warm-Up Time

The 8EM5 is the same as the 6EM5 except for the following items:

Heater Characteristics and Ratings (*Design-Center Values*):

Current	0.600 ± 0.040	amp
Voltage (AC or DC) at heater amperes = 0.600	8.4	volts
Warm-up time (Average).	11	sec





Twin Diode— Sharp-Cutoff Pentode

9-PIN MINIATURE TYPE

With Heater Having Controlled Warm-Up Time

GENERAL DATA

Electrical:

Heater, for Unipotential Cathodes:

Voltage (AC or DC)	8	volts
Current	0.6 ± 6%	amp
Warm-up time (Average)	11	sec

Direct Interelectrode Capacitances:^a*Diode Units:*

Either plate to cathode & internal shield, pentode grid No.3 & pentode cathode & pentode internal shield, and heater	1.5	μf
Cathode & internal shield to either plate, pentode grid No.3 & pentode cathode & pentode internal shield, and heater	7.5	μf

Pentode Unit:

Grid No.1 to plate	0.1 max.	μf
Grid No.1 to cathode & grid No.3 & internal shield, grid No.2, diode-units cathode & diode-units internal shield, and heater	10	μf
Plate to cathode & grid No.3 & internal shield, grid No.2, diode-units cathode & diode-units internal shield, and heater	4.2	μf
Pentode grid No.1 to either diode plate	0.005 max.	μf
Pentode plate to either diode plate	0.02 max.	μf

Characteristics, Class A₁ Amplifier (Pentode Unit):

Plate Supply Voltage	60	200	volts
Grid-No.2 Supply Voltage	150	150	volts
Grid-No.1 Voltage	0	-	volts
Cathode Resistor	-	100	ohms
Plate Resistance (Approx.)	-	60000	ohms
Transconductance	-	11500	μmhos
Plate Current	55 ^b	25	ma
Grid-No.2 Current	18 ^b	5.5	ma
Grid-No.1 Voltage (Approx.) for plate $\mu a = 100$	-	-10	volts

Mechanical:

Operating Position	Any
Maximum Overall Length	2-5/8"
Maximum Seated Length	2-3/8"
Length, Base Seat to Bulb Top (Excluding tip)	2" ± 3/32"
Diameter	0.750" to 0.875"



8ET7

Dimensional Outline. See *General Section*
 Bulb T6-1/2
 Base Small-Button Noval 9-Pin (JEDEC No.E9-1)
 Basing Designation for BOTTOM VIEW 9LT

Pin 1 - Diode-Units
 Cathode,
 Internal
 Shield
 Pin 2 - Diode
 Plate No.2
 Pin 3 - Diode
 Plate No.1
 Pin 4 - Heater
 Pin 5 - Heater

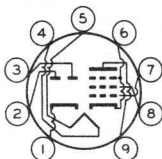

Pin 6 - Pentode
 Grid No.3,
 Cathode,
 Internal
 Shield
 Pin 7 - Pentode
 Grid No.1
 Pin 8 - Pentode
 Grid No.2
 Pin 9 - Pentode Plate

PENTODE — AMPLIFIER — Class A₁

Maximum Ratings, *Design-Maximum Values:*

PLATE VOLTAGE. 330 max. volts
 GRID-No.2 (SCREEN-GRID) SUPPLY VOLTAGE . . 330 max. volts
 GRID-No.2 VOLTAGE. See *Grid-No.2 Input Rating*
 Chart at front of Receiving Tube Section
 GRID-No.1 (CONTROL-GRID) VOLTAGE:
 Positive-bias value. 0 max. volts
 GRID-No.2 INPUT:
 For grid-No.2 voltages up to 165 volts . 1.1 max. watts
 For grid-No.2 voltages between 165
 and 330 volts. See *Grid-No.2 Input Rating*
 Chart at front of Receiving Tube Section
 PLATE DISSIPATION. 5 max. watts
 PEAK HEATER-CATHODE VOLTAGE:
 Heater negative with respect to cathode. 200 max. volts
 Heater positive with respect to cathode. 200^c max. volts

Maximum Circuit Values:

Grid-No.1-Circuit Resistance:
 For fixed-bias operation 0.1 max. megohm
 For cathode-bias operation 0.25 max. megohm

DIODE UNITS — Two

Values are for Each Unit

Maximum Ratings, *Design-Maximum Values:*

DC PLATE CURRENT 3 max. ma
 PEAK HEATER-CATHODE VOLTAGE:
 Heater negative with respect to cathode. 200 max. volts
 Heater positive with respect to cathode. 200^c max. volts

Characteristics, Instantaneous Test Condition:

Plate Current for plate volts = 10 1.5 ma

^a Without external shield.

^b This value can be measured by a method involving a recurrent wave form such that the maximum ratings of the tube will not be exceeded.

^c The dc component must not exceed 100 volts.



8FQ7

Medium-Mu Twin Triode

The 8FQ7 is the same as the 6FQ7 except for the following items:

Heater Characteristics and Ratings

Current.	0.450 ± 0.030	A
Voltage (AC or DC) at 0.450 A	8.4	V
Warm-up time (Average)	11	s

8GJ7

Medium-Mu Triode—Sharp-Cutoff Pentode

The 8GJ7 is the same as the 6GJ7 except for the following items:

Heater Characteristics and Ratings

Current.	0.300 ± 0.020	A
Voltage (AC or DC) at 0.300A	8.0	V
Warm-up time (Average)	11	s

8GN8

High-Mu Triode—Sharp-Cutoff Pentode

The 8GN8 is the same as the 6GN8 except for the following items:

Heater Characteristics and Ratings

Current.	0.600 ± 0.040	A
Voltage (AC or DC) at 0.600 A	8.0	V
Warm-up time (Average)	11	s

8GU7

Medium-Mu Twin Triode

The 8GU7 is the same as the 6GU7 except for the following items:

Heater Characteristics and Ratings

Current.	0.450 ± 0.030	A
Voltage (AC or DC) at 0.450 A.	8.4	V
Warm-up time (Average)	11	s



8JU8A

Quadruple Diode

The 8JU8A is the same as the 6JU8A except for the following items:

Heater Characteristics and Ratings

Current	0.450 ± 0.030	A
Voltage (AC or DC) at 0.450 A	8.4	V
Warm-up time (Average)	11	s

8JV8

High-Mu Triode—Sharp-Cutoff Pentode

The 8JV8 is the same as the 6JV8 except for the following items:

Heater Characteristics and Ratings

Current	0.450 ± 0.030	A
Voltage (AC or DC) at 0.450 A	8.5	V
Warm-up time (Average)	11	s

8KA8

High-Mu Triode—Sharp-Cutoff Pentode

Pentode Unit Has Two Independent Control Grids

The 8KA8 is the same as the 6KA8 except for the following items:

Heater Characteristics and Ratings

Current	0.450 ± 0.030	A
Voltage (AC or DC) at 0.450 A	8.4	V
Warm-up time (Average)	11	s

8LC8

High-Mu Triode—Sharp-Cutoff Pentode

The 8LC8 is the same as the 6LC8 except for the following items:

Heater Characteristics and Ratings

Current	0.450 ± 0.030	A
Voltage (AC or DC) at 0.450 A	8.4	V
Warm-up time (Average)	11	s



Medium-Mu Twin Triode

The 9AU7 is the same as the 12AU7A except for the following items:

Heater, for Unipotential Cathodes

	Series	Parallel	
Heater arrangement			
Voltage (AC or DC)	9.4 ± 10%	4.7	V
Current	0.225	0.45 ± 6%	A
Warm-up time (Average)	-	11	s

10AL11

Beam Power Tube—Sharp-Cutoff Pentode

DUODECAR TYPE

The 10AL11 is the same as the 6AL11 except for the following items:

Heater Characteristics and Ratings

Current	0.600 ± 0.040	A
Voltage (AC or DC) at 0.600 A	9.8	V
Warm-up Time (Average)	11	s

10DE7

Dual Triode

With Medium-Mu Unit and Low-Mu Unit

The 10DE7 is the same as the 6DE7 except for the following items:

Heater Characteristics and Ratings

Current	0.600 ± 0.040	A
Voltage (AC or DC) at 0.600 A	9.7	V
Warm-up time (Average)	11	s



10DR7

Dual Triode

With Medium-Mu Unit and Low-Mu Unit

The 10DR7 is the same as the 6DR7 except for the following items:

Heater Characteristics and Ratings

Current	0.600 ± 0.040	A
Voltage (AC or DC) at 0.600 A	9.7	V
Warm-up time (Average).	11	s

10DX8

High-Mu Triode — Sharp-Cutoff Pentode

The 10DX8 is the same as the 6DX8 except for the following items:

Heater Characteristics and Ratings

Current	0.450 ± 0.030	A
Voltage (AC or DC) at 0.450 A	10.2	V



Dual Triode

With Medium-Mu Unit and Low-Mu Unit

For Equipment Having Series Heater-String Arrangement

GENERAL DATA

Electrical:

Heater, for Unipotential Cathodes:

Voltage (AC or DC)	9.7	volts
Current	0.6 ± 6%	amp
Warm-up time (Average)	11	sec

Direct Interelectrode Capacitances (Approx.):[▲]

	Unit No.1	Unit No.2	
Grid to plate	4.4	9.5	μμf
Grid to cathode and heater. . .	2.2	7	μμf
Plate to cathode and heater . .	0.6	1.6	μμf

Characteristics, Class A₁ Amplifier:

	Unit No.1	Unit No.2	
Plate Voltage	250	150	volts
Grid Voltage.	-11	-17.5	volts
Amplification Factor.	17.5	6	
Plate Resistance (Approx.) . . .	8750	800	ohms
Transconductance.	2000	7500	μmhos
Plate Current	5.5	45	ma
Plate Current for grid volts = -25.	-	8	ma
Plate Current for plate volts = 60 and grid volts = 0	-	95•	ma
Grid Voltage (Approx.) for plate μa = 10	-20	-	volts
Grid Voltage (Approx.) for plate μa = 100.	-	-40	volts

Mechanical:

Operating Position.	Any
Maximum Overall Length.	3"
Maximum Seated Length	2-7/16"
Maximum Diameter.	1-9/32"
Bulb.	T9
Base.	Short Intermediate-Shell Octal 8-Pin

with External Barriers (JEDEC Group 1, No. B8-58)

Basing Designation for BOTTOM VIEW. 8BD

- Pin 1 - Grid of Unit No.2
- Pin 2 - Plate of Unit No.2
- Pin 3 - Cathode of Unit No.2
- Pin 4 - Grid of Unit No.1

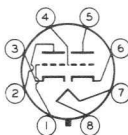

- Pin 5 - Plate of Unit No.1
- Pin 6 - Cathode of Unit No.1
- Pin 7 - Heater
- Pin 8 - Heater



10EG7

VERTICAL-DEFLECTION OSCILLATOR

Values are for Unit No. 1

Maximum Ratings, Design-Maximum Values:

For operation in a 525-line, 30-frame system*

DC PLATE VOLTAGE.	330	max.	volts
PEAK NEGATIVE-PULSE GRID VOLTAGE.	400	max.	volts
CATHODE CURRENT:			
Peak.	77	max.	ma
Average	22	max.	ma
PLATE DISSIPATION	1.5	max.	watts
PEAK HEATER-CATHODE VOLTAGE:			
Heater negative with respect to cathode.	200	max.	volts
Heater positive with respect to cathode.	200	max.	volts

Maximum Circuit Values:

Grid-Circuit Resistance:

For cathode-bias operation. 2.2 max. megohms

VERTICAL-DEFLECTION AMPLIFIER

Values are for Unit No. 2

Maximum Ratings, Design-Maximum Values:

For operation in a 525-line, 30-frame system*

DC PLATE VOLTAGE.	330	max.	volts
PEAK POSITIVE-PULSE PLATE VOLTAGE [‡]	1500	max.	volts
PEAK NEGATIVE-PULSE GRID VOLTAGE.	250	max.	volts
CATHODE CURRENT:			
Peak.	175	max.	ma
Average	50	max.	ma
PLATE DISSIPATION	10	max.	watts
PEAK HEATER-CATHODE VOLTAGE:			
Heater negative with respect to cathode.	200	max.	volts
Heater positive with respect to cathode.	200	max.	volts

Maximum Circuit Values:

Grid-Circuit Resistance:

For cathode-bias operation. 2.2 max. megohms

▲ Without external shield.

• This value can be measured by a method involving a recurrent wave form such that the maximum ratings of the tube will not be exceeded.

★ As described in "Standards of Good Engineering Practice Concerning Television Broadcast Stations," Federal Communications Commission.

‡ The dc component must not exceed 100 volts.

• This rating is applicable where the duration of the voltage pulse does not exceed 15 per cent of one vertical scanning cycle. In a 525-line, 30-frame system, 15 per cent of one vertical scanning cycle is 2.5 milliseconds.

DIMENSIONAL OUTLINE

shown under Type 6EM7 also applies to the 10EG7



10EM7

Dual Triode With High-Mu Unit and Low-Mu Unit

The 10EM7 is the same as the 6EM7 except for the following items:

Heater Characteristics and Ratings:

Current.	0.600 ± 0.040	amp
Voltage (AC or DC) at heater amperes = 0.600	9.7	volts
Warm-up time (Average)	11	sec

10GF7

Dual Triode With High-Mu Unit and Low-Mu Unit

NOVAR TYPE

The 10GF7 is the same as the 6GF7 except for the following items:

Heater Characteristics and Ratings:

Current.	0.600 ± 0.040	amp
Voltage (AC or DC) at heater amperes = 0.600	9.7	volts
Warm-up time (Average)	11	sec

10GF7A

Dual Triode With High-Mu Unit and Low-Mu Unit

NOVAR TYPE

The 10GF7A is the same as the 6GF7A except for the following items:

Heater Characteristics and Ratings:

Current.	0.600 ± 0.040	amp
Voltage (AC or DC) at heater amperes = 0.600.	9.7	volts
Warm-up time (Average)	11	sec



10GN8

High-Mu Triode— Sharp-Cutoff Pentode

9-PIN MINIATURE TYPE

The 10GN8 is the same as the 6GN8 except for the following items:

Heater Characteristics and Ratings:

Current.	0.450 ± 0.030	amp
Voltage (AC or DC) at heater amperes = 0.450	10.5	volts
Warm-up time (Average)	11	sec

10HF8

High-Mu Triode— Sharp-Cutoff Pentode

9-PIN MINIATURE TYPE

The 10HF8 is the same as the 6HF8 except for the following items:

Heater Characteristics and Ratings:

Current.	0.450 ± 0.030	amp
Voltage (AC or DC) at heater amperes = 0.450	10.5	volts
Warm-up time (Average)	11	sec



High-Mu Triode— Sharp-Cutoff Pentode

9-PIN MINIATURE TYPE

For Equipment Having Series Heater-String Arrangement

The 10HF8 is the same as the 6HF8 except for the following items:

Heater, for Unipotential Cathodes:

Voltage (AC or DC)	10.5	volts
Current	0.45 ± 6%	amp
Warm-up time (Average)	11	sec

11CY7

Dual Triode

With High-Mu Unit and Low-Mu Unit

9-PIN MINIATURE TYPE

For Equipment Having Series Heater-String Arrangement

The 11CY7 is the same as the 6CY7 except for the following items:

Heater, for Unipotential Cathodes:

Voltage (AC or DC)	11	volts
Current	0.45 ± 6%	amp
Warm-up time (Average)	11	sec





High-Mu Triode— Sharp-Cutoff Pentode

9-PIN MINIATURE TYPE

For Use in Sync-Separator, Sync-Clipper, Voltage Amplifier, Phase-Inverter, and Video Output Amplifier Circuits in TV Receivers

Electrical:

Heater Characteristics and Ratings:

Current	0.450 ± 0.030	amp
Voltage (AC or DC) at heater amperes = 0.450	10.5	volts
Warm-up time (Average)	11	sec
Peak heater-cathode voltage (Each Unit):		
Heater negative with respect to cathode	200	max. volts
Heater positive with respect to cathode	200 ^a	max. volts

Direct Interelectrode Capacitances:^b

Triode Unit:

G _T to P _T	4.0	pf
Input: G _T to (K _T , K _p +G _{3p} +I _S , H)	2.6	pf
Output: P _T to (K _T , K _p +G _{3p} +I _S , H)	2.6	pf

Pentode Unit:

G _{1p} to P _p	0.1 max.	pf
Input: G _{1p} to (K _p +G _{3p} +I _S , G _{2p} , H)	11	pf
Output: P _p to (K _p +G _{3p} +I _S , G _{2p} , H)	4.4	pf
G _{1p} to P _T	0.005 max.	pf
P _p to G _T	0.018 max.	pf
P _p to P _T	0.17 max.	pf

Characteristics, Class A₁ Amplifier:

	Triode Unit		
Plate Voltage	135	200	volts
Grid Voltage	-2	-2	volts
Amplification Factor	60	70	
Plate Resistance (Approx.)	39000	19000	ohms
Transconductance	1550	3700	μmhos
Plate Current	1	3.5	ma
Grid-No.1 Voltage (Approx.) for plate μ _a = 10	-4.8	-7	volts

	Pentode Unit			
Plate Voltage	30	135	200	volts
Grid-No.2 Voltage	135	135	135	volts
Grid-No.1 Voltage	0	-1.5	-1.5	volts
Plate Resistance (Approx.)	-	66000	70000	ohms
Transconductance	-	12600	14000	μmhos
Plate Current	32 ^c	17	18	ma
Grid-No.2 Current	14 ^c	4.2	4	ma
Grid-No.1 Voltage (Approx.) for plate μ _a = 10	-	-5	-5	volts



10JA8

Mechanical:

Operating Position	Any
Types of Cathodes	Coated Unipotential
Maximum Overall Length	2-5/8"
Maximum Seated Length	2-3/8"
Length, Base Seat to Bulb Top (Excluding tip)	2" ± 3/32"
Diameter	0.750" to 0.875"
Dimensional Outline	See <i>General Section</i>
Bulb	T6-1/2
Base	Small-Button Noval 9-Pin (JEDEC No. E9-1)
Basing Designation for BOTTOM VIEW	9DX

- Pin 1 - Triode Cathode
- Pin 2 - Triode Grid
- Pin 3 - Triode Plate
- Pin 4 - Heater
- Pin 5 - Heater
- Pin 6 - Pentode Cathode,
Pentode Grid No.3,
Internal Shield
- Pin 7 - Pentode Grid No.1
- Pin 8 - Pentode Grid No.2
- Pin 9 - Pentode Plate

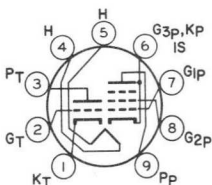

AMPLIFIER — Class A₁

Maximum Ratings, Design-Maximum Values:

	<i>Triode Unit</i>	<i>Pentode Unit</i>	
Plate Voltage	300 max.	330 max.	volts
Grid-No.2 (Screen-Grid) Supply Voltage	-	330 max.	volts
Grid-No.2 Voltage	See <i>Grid-No.2 Input Rating Chart</i> at front of Receiving Tube Section		
Grid-No.1 (Control-Grid) Voltage:			
Positive-bias value	0 max.	0 max.	volts
Plate Dissipation	1 max.	5 max.	watts
Grid-No.2 Input:			
For grid-No.2 voltages up to 165 volts	-	1.5 max.	watts
For grid-No.2 voltages between 165 and 330 volts	See <i>Grid-No.2 Input Rating Chart</i> at front of Receiving Tube Section		

Maximum Circuit Values:

	<i>Triode Unit</i>	<i>Pentode Unit</i>	
Grid-No.1 Circuit Resistance:			
For cathode-bias operation	1.0 max.	1.0 max.	megohm
For fixed-bias operation	0.5 max.	0.25 max.	megohm



- a The dc component must not exceed 100 volts.
 b Without external shield.
 c This value can be measured by a method involving a recurrent waveform such that the maximum ratings of the tube will not be exceeded.

AVERAGE PLATE CHARACTERISTICS Triode Unit

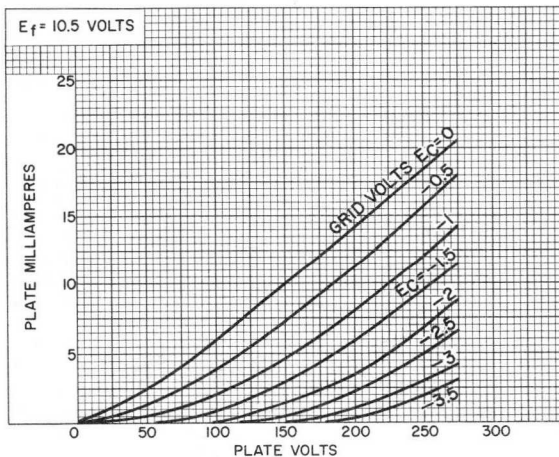

92CS-12158



AVERAGE CHARACTERISTICS Pentode Unit

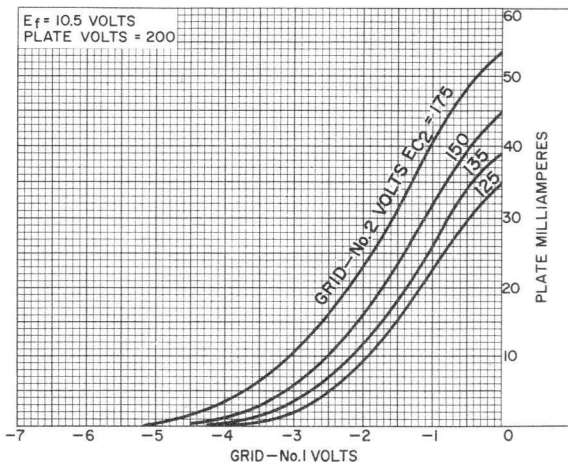

92CS-12160

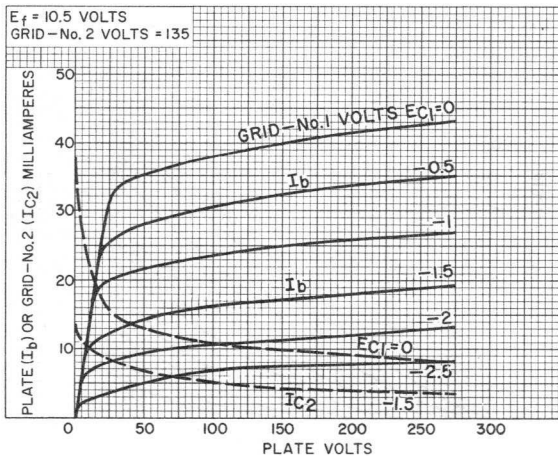

92CS-12159

10LE8

Twin Dual-Control Pentode

The 10LE8 is the same as the 6LE8 except for:

Heater Characteristics and Ratings

Current	0.450 ± 0.030	A
Voltage (AC or DC) at 0.450 A	10	V
Warm-up time (Average).	11	s

11AR11

Semiremote-Cutoff Twin Pentode

DUODECAR TYPE

The 11AR11 is the same as the 6AR11 except for:

Heater Characteristics and Ratings

Current	0.450 ± 0.030	A
Voltage (AC or DC) at 0.450 A	11.2	V
Warm-up time (Average).	11	s

11CY7

Dual Triode

With High-Mu Unit and Low-Mu Unit

The 11CY7 is the same as the 6CY7 except for:

Heater Characteristics and Ratings

Current	0.450 ± 0.030	A
Voltage (AC or DC) at 0.450 A	11.0	V
Warm-up time (Average).	11	s

11DS5

Beam Power Tube

The 11DS5 is the same as the 6DS5 except for:

Heater Characteristics and Ratings

Current	0.450 ± 0.030	A
Voltage (AC or DC) at 0.450 A	11.2	V
Warm-up time (Average).	11	s

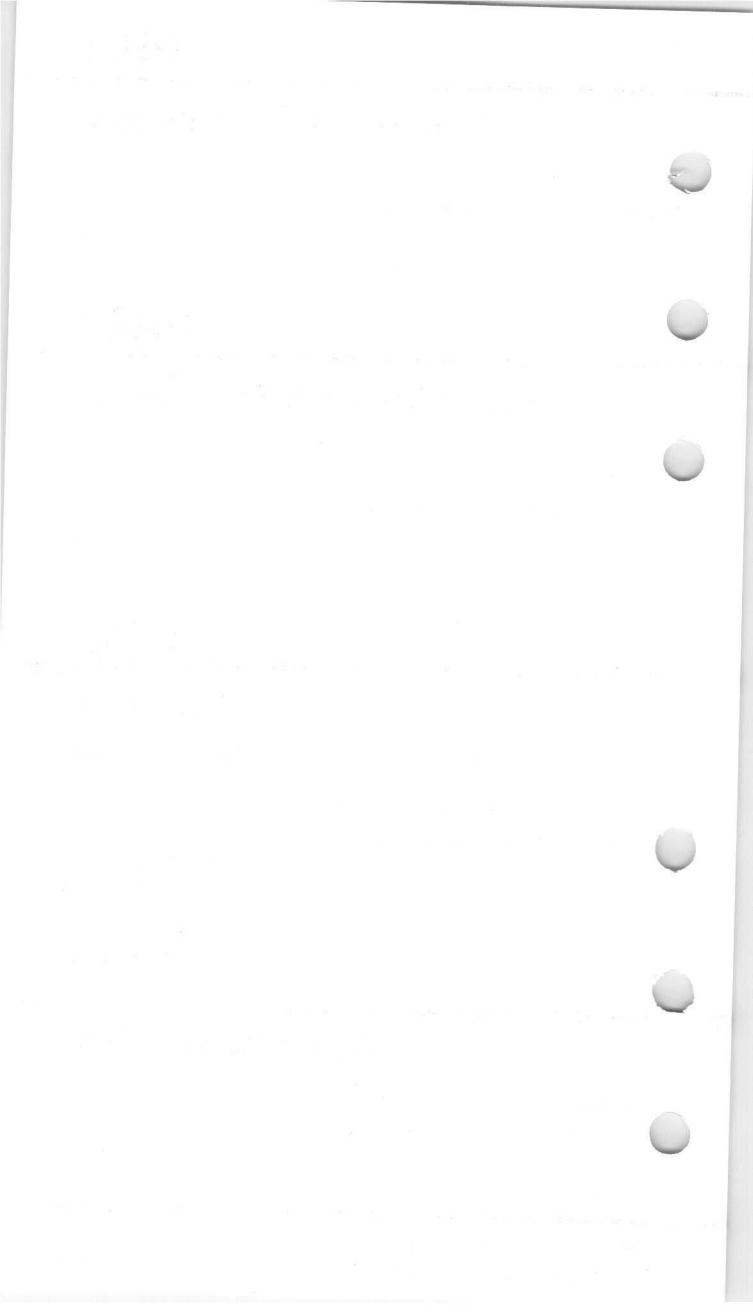

Sharp-Cutoff Pentode

9-PIN MINIATURE TYPE

FRAME-GRID CONSTRUCTION

$g_m = 30000 \mu\text{mho}$

For Video-Output Amplifier Service in Color-TV Receivers

ELECTRICAL CHARACTERISTICS

Bogey Values^a

		Series	Parallel	
Heater Voltage (AC or DC) . . .	E_h	11.0	5.50	V
Heater Current	I_h	300	600	mA
Direct Interelectrode Capacitances				
Without external shield				
Grid No.1 to plate	C_{g1-p}		0.15 max	pF
Input: G1 to (K, G3 + IS, G2, H).				
	C_i		14	pF
Output: P to (K, G3 + IS, G2, H).				
	C_o		5.0	pF

For the following characteristics, see Conditions

Plate Resistance (Approx.) . . .	r_p	40	k Ω
Transconductance	g_m	30000	μmho
DC Plate Current	I_b	30	mA
DC Grid-No.2 Current	I_{c2}	5.2	mA
Cutoff DC Grid-No.1 Voltage. .	$E_{c1}(co)$	-4.5	V

Plate $\mu A = 100$

Conditions

		Bogey Value	V
Heater Voltage	E_h	200	V
DC Plate Supply Voltage. . . .	E_{bb}	0	V
DC Grid-No.3 Voltage	E_{c3}	135	V
DC Grid-No.2 Supply Voltage. .	E_{cc2}	0	V
DC Grid-No.1 Supply Voltage. .	E_{cc1}	47	Ω
Cathode Resistor	R_k		

MECHANICAL CHARACTERISTICS

Operating Position	Any
Type of Cathode.	Coated Unipotential
Maximum Overall Length	2.625 in
Maximum Seated Length.	2.375 in
Maximum Diameter	0.875 in
Dimensional Outline (JEDEC 6-3).	See <i>General Section</i>
Envelope	JEDEC T6-1/2
Base	Small-Button Noval 9-Pin (JEDEC E9-1)

TERMINAL DIAGRAM (Bottom View)

- Pin 1 - Cathode
- Pin 2 - Grid No.1
- Pin 3 - Grid No.3,
Internal Shield
- Pin 4 - Heater
- Pin 5 - Heater
- Pin 6 - Heater Tap
- Pin 7 - Plate
- Pin 8 - Grid No.2
- Pin 9 - Grid No.3,
Internal Shield

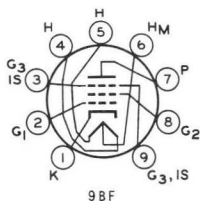

9BF



DESIGN-MAXIMUM RATINGS

For operation as a Class A₁ Amplifier Tube

DC Plate Voltage.	E_b	330	V
DC Grid-No.2 (Screen-Grid) Supply Voltage	E_{c2}	See <i>Grid-No.2 Input Rating Chart</i> at front of Receiving Tube Section	
DC Grid-No.1 (Control-Grid) Voltage			
Positive-bias value	E_{c1}	0	V
Heater-Cathode Voltage			
Peak.	e_{hkm}	±200	V
Average ^b	$E_{hk(av)}$	100	V
Heater Voltage (AC or DC)	E_f		
Series.	-	9.9 min	12.1 max V
Parallel.	-	4.95 min	6.05 max V
Grid-No.2 Input	P_{g2}		
For $E_{c2} \leq 165$ V	-		1 W
For $E_{c2} > 165$ V and ≤ 330 V	-	See <i>Grid-No.2 Input Rating Chart</i> at front of Receiving Tube Section	
Plate Dissipation	P_b	7	W

MAXIMUM CIRCUIT VALUES

Grid-No.1 Circuit Resistance $R_{g1(ckt)}$			
For fixed-bias operation.	-	0.1	MΩ
For cathode-bias operation.	-	0.25	MΩ

^a Unless otherwise specified.

^b Measured with a dc meter.



Typical Characteristics

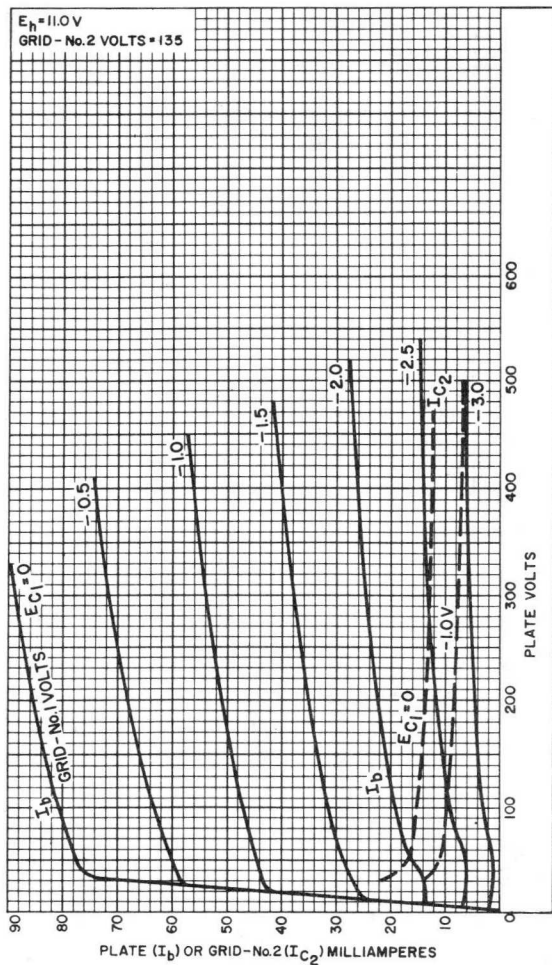

92CM-13833



Typical Characteristics

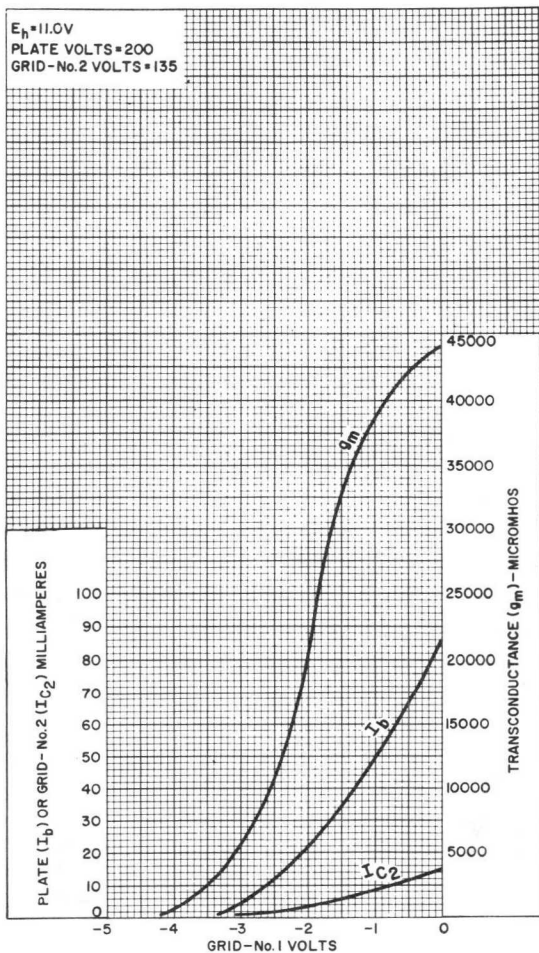

92CM-13832



11KV8

High-Mu Triode— Sharp-Cutoff Pentode

The 11KV8 is the same as the 6KV8 except for the following items:

Heater Characteristics and Ratings

Current	0.450 ± 0.030	A
Voltage (AC or DC) at 0.450 A	10.9	V
Warm-up time (Average).	11	s

11LQ8

Medium-Mu Triode— Sharp-Cutoff Pentode

The 11LQ8 is the same as the 6LQ8 except for the following items:

Heater Characteristics and Ratings

Current	0.450 ± 0.030	A
Voltage (AC or DC) at 0.450 A	10.9	V
Warm-up time (Average).	11	s





Medium-Mu Triode— Sharp-Cutoff Pentode

9-PIN MINIATURE TYPE

FRAME-GRID CONSTRUCTION (PENTODE UNIT)

For Use in Black-and-White TV Receivers Having Low-Voltage Power Supplies. Triode Unit Useful in Sync-Separator, Sound-IF Circuits, and as a General-Purpose Voltage-Amplifier Tube. Pentode Unit Especially Suited for Video Output Service.

Electrical:

Heater Characteristics and Ratings:

Current	0.450 ± 0.030	amp
Voltage (AC or DC) at heater amperes = 0.450	10.9	volts
Warm-up time (Average)	11	sec
Peak heater-cathode voltage:		
Heater negative with respect to cathode	200 max.	volts
Heater positive with respect to cathode	200 ^a max.	volts

Direct Interelectrode Capacitances
(Approx.):^b

Triode Unit:

Grid to plate	2.8	pf
Input: G _T to (K _T , K _P +G _{3P} +IS, H) . .	4.2	pf
Output: P _T to (K _T , K _P +G _{3P} +IS, H) . .	2.4	pf

Pentode Unit:

Grid No.1 to plate	0.090 max.	pf
Input: G _{1P} to (K _P +G _{3P} +IS, G _{2P} , H) . .	14	pf
Output: P _P to (K _P +G _{3P} +IS, G _{2P} , H) . .	4.8	pf
Triode grid to pentode plate	0.015 max.	pf
Pentode plate to triode plate	0.17 max.	pf

Characteristics, Class A₁ Amplifier:

	<i>Triode Unit</i>	<i>Pentode Unit</i>		
Plate Supply Voltage	125	125	200 ^a	volts
Grid-No.2 Supply Voltage	-	125	125	volts
Grid-No.1 Supply	Connected	to negative end of cathode resistor		
Cathode Resistor	68	82	68	ohms
Amplification Factor	46	-	-	
Plate Resistance (Approx.)	4400	5500	7500	ohms
Transconductance	10400	21000	23000	μmhos
Plate Current	15	19	22	ma
Grid-No.2 Current	-	3.8	4	ma
Grid-No.1 Voltage (Approx.) for plate μ _a = 100	-6	-4.2	-4.2	volts

^a The dc component must not exceed 100 volts.

^b Without external shield.



Mechanical:

Operating Position Any
 Type of Cathodes Coated Unipotential
 Maximum Overall Length 2-5/8"
 Maximum Seated Length 2-3/8"
 Length, Base Seat to Bulb Top (Excluding tip) 2" ± 3/32"
 Diameter 0.750" to 0.875"
 Dimensional Outline See *General Section*
 Bulb T6-1/2
 Base Small-Button Noval 9-Pin (JEDEC No. E9-1)
 Basing Designation for BOTTOM VIEW 9DX

- Pin 1 - Triode Cathode
- Pin 2 - Triode Grid
- Pin 3 - Triode Plate
- Pin 4 - Heater
- Pin 5 - Heater
- Pin 6 - Pentode Grid No. 3,
Pentode Cathode,
Internal Shield
- Pin 7 - Pentode Grid No. 1
- Pin 8 - Pentode Grid No. 2
- Pin 9 - Pentode Plate

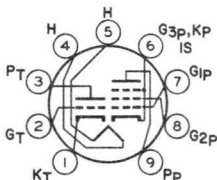

AMPLIFIER — Class A₁

Maximum Ratings, Design-Maximum Values:

	Triode Unit	Pentode Unit	
Plate Voltage	300 max.	300 max.	volts
Grid-No. 2 (Screen-grid) Supply Voltage	-	300 max.	volts
Grid-No. 2 Voltage	-	See <i>Grid-No. 2 Input Rating Chart</i> at front of Receiving Tube Section	
Grid-No. 1 (Control-grid) Voltage:			
Positive-bias value	0 max.	0 max.	volts
Grid-No. 2 Input:			
For grid-No. 2 voltages up to 150 volts	-	1 max.	watt
For grid-No. 2 voltages between 150 and 300 volts	-	See <i>Grid-No. 2 Input Rating Chart</i> at front of Receiving Tube Section	
Plate Dissipation	2 max.	5 max.	watts

Maximum Circuit Values:

	Triode Unit	Pentode Unit	
Grid-No. 1-Circuit Resistance:			
For fixed-bias operation	0.5 max.	0.1 max.	megohm
For cathode-bias operation	1 max.	0.25 max.	megohm



AVERAGE CHARACTERISTICS Triode Unit

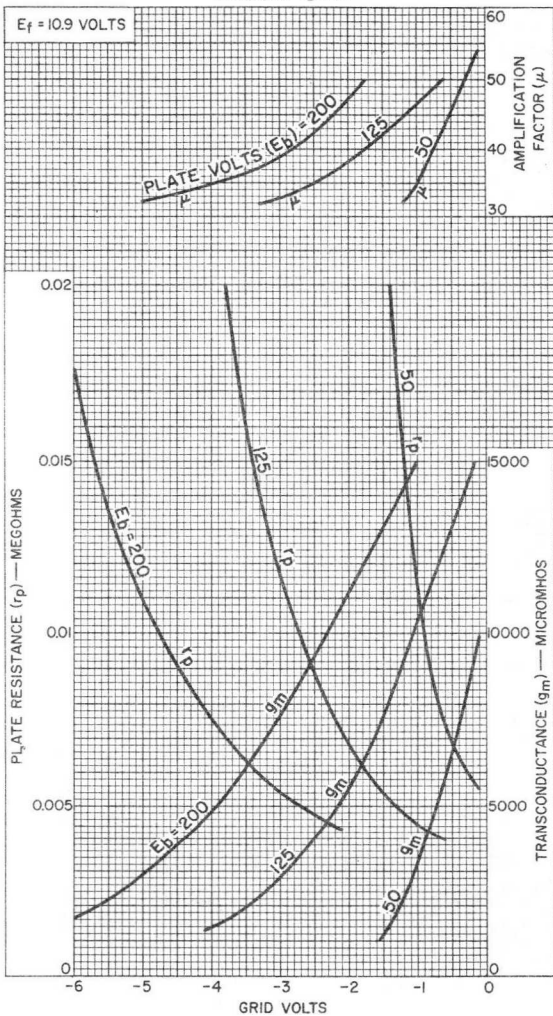

92CM-12623



AVERAGE PLATE CHARACTERISTICS Triode Unit

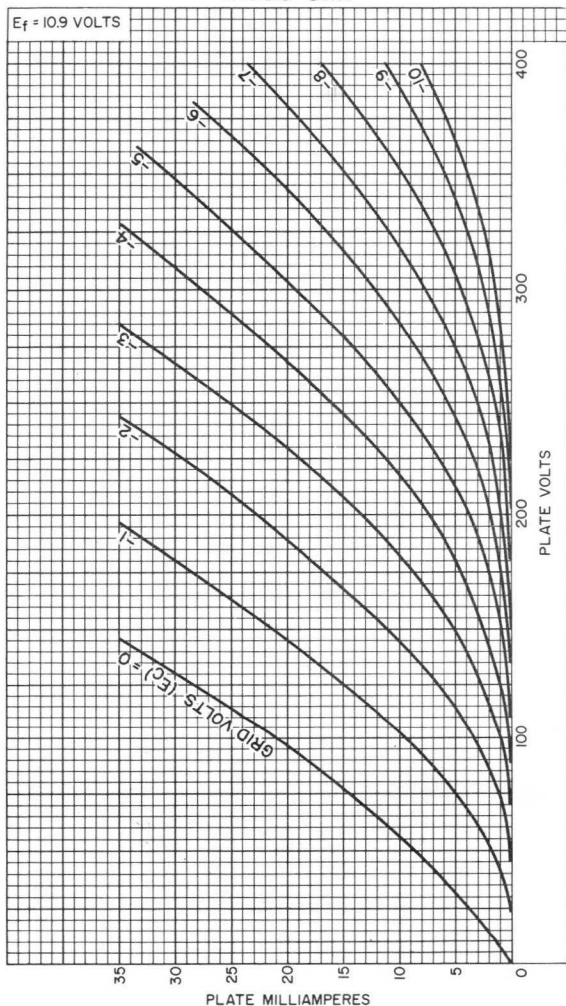

92CM-12616



AVERAGE CHARACTERISTICS

Pentode Unit

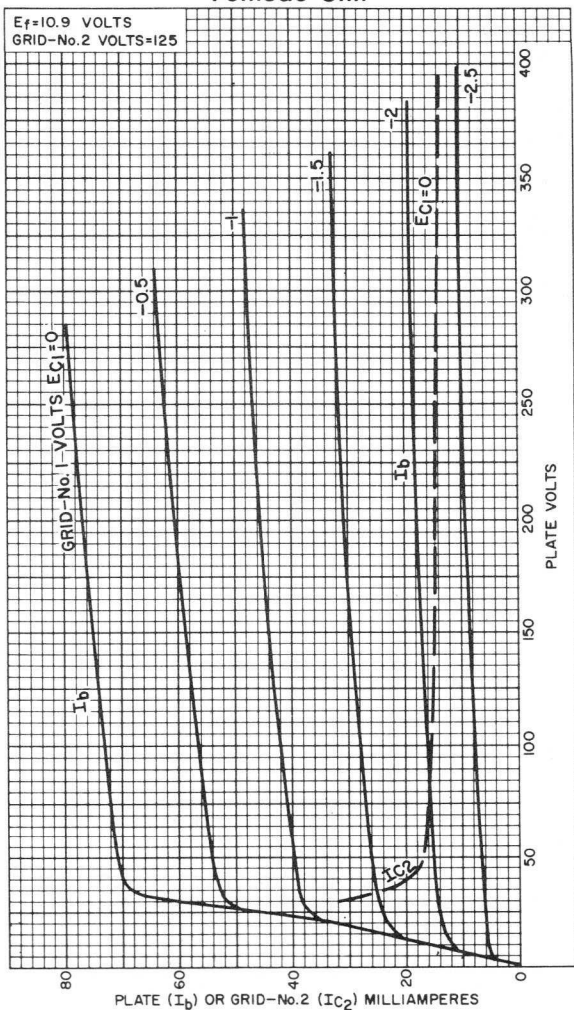

92CM-12655



11LQ8

AVERAGE CHARACTERISTICS Pentode Unit

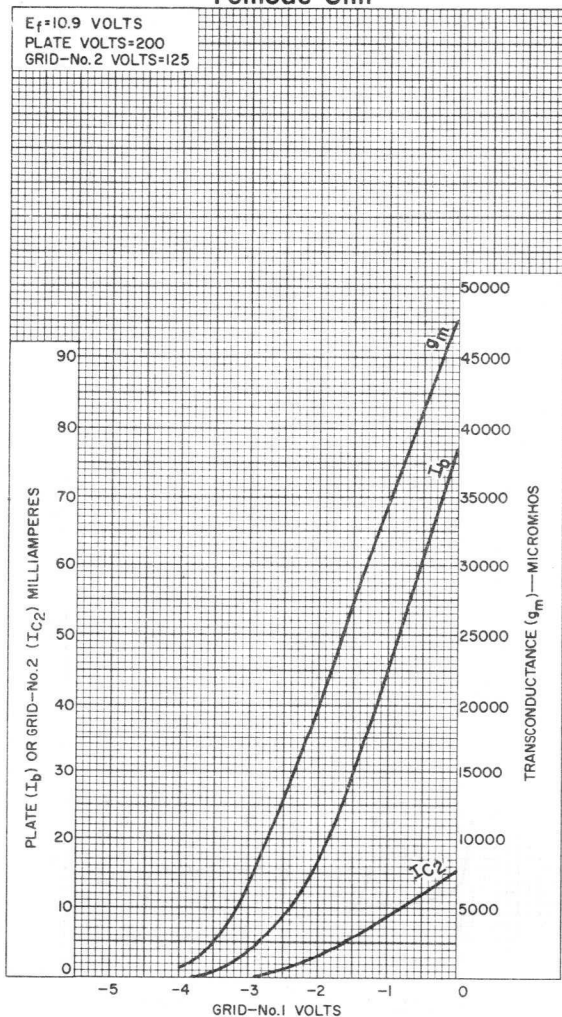

92CM-12654





12AB5

12AB5

BEAM POWER TUBE

9-PIN MINIATURE TYPE

For use in automobile radio receivers
operating from 12-volt storage batteries

GENERAL DATA

Electrical:

Heater*, for Unipotential Cathode:

Voltage range. 10.0 to 15.9 dc volts

This voltage range is on an absolute basis. For longest life, it is recommended that the heater be operated within the voltage range of 11 to 14 volts.

Current (Approx.),
at 12.6 volts. 0.2 amp

Direct Interelectrode Capacitances:^o

Grid No.1 to plate 0.7 max. μf

Grid No.1 to cathode & grid No.3,
grid No.2, and heater. 8 μf

Plate to cathode & grid No.3,
grid No.2, and heater. 8.5 μf

Mechanical:

Mounting Position. Any

Maximum Overall Length 2-5/8"

Maximum Seated Length. 2-3/8"

Length, Base Seat to Bulb Top (Excluding tip). . . 2" \pm 3/32"

Maximum Diameter 7/8"

Dimensional Outline. See General Section

Bulb T-6-1/2

Base Small-Button Noval 9-Pin (JETEC No.E9-1)

Basing Designation for BOTTOM VIEW 9EU

Pin 1 - Grid No.2

Pin 2 - No Connection

Pin 3 - Grid No.1

Pin 4 - Heater

Pin 5 - Heater

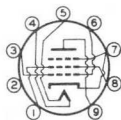

Pin 6 - Grid No.1

Pin 7 - Cathode,
Grid No.3

Pin 8 - Grid No.2

Pin 9 - Plate

AF POWER AMPLIFIER - Class A₁

Maximum Ratings, Design-Center Values:

For application of these design-center ratings to storage-battery operation, see Operating Considerations

PLATE VOLTAGE. 315 max. volts

GRID-No.2 (SCREEN) VOLTAGE 285 max. volts

PLATE DISSIPATION. 12 max. watts

GRID-No.2 INPUT. 2 max. watts

PEAK HEATER-CATHODE VOLTAGE:

Heater negative with respect to cathode. 90 max. volts

Heater positive with respect to cathode. 90 max. volts

BULB TEMPERATURE (At hottest point
on bulb surface) 250 max. °C

* °: see next page.

SEPT. 1, 1955

TUBE DIVISION

TENTATIVE DATA 1

12AB5



12AB5

BEAM POWER TUBE

Characteristics with 12.6 volts on heater:

Plate Voltage.	250	250	volts
Grid-No.2 Voltage.	200	250	volts
Grid-No.1 (Control-Grid) Voltage	-	-12.5	volts
Cathode-Bias Resistor.	270	-	ohms
Peak AF Grid-No.1 Voltage.	10.5	12.5	volts
Zero-Signal Plate Current.	33.5	45	ma
Max.-Signal Plate Current.	36	47	ma
Zero-Signal Grid-No.2 Current (Approx.)	1.6	4.5	ma
Max.-Signal Grid-No.2 Current (Approx.)	3.2	7	ma
Plate Resistance (Approx.)	75000	50000	ohms
Transconductance	4000	4100	μ hos
Load Resistance.	6000	5000	ohms
Total Harmonic Distortion.	8	8	%
Max.-Signal Power Output	3.3	4.5	watts

Maximum Circuit Values:

Grid-No.1-Circuit Resistance:

For fixed-bias operation	0.1 max.	megohm
For cathode-bias operation	0.5 max.	megohm

PUSH-PULL AF POWER AMPLIFIER - Class AB₁

Maximum Ratings, Design-Center Values:

For application of these design-center ratings to storage-battery operation, see Operating Considerations

PLATE VOLTAGE.	315 max.	volts
GRID-No.2 (SCREEN) VOLTAGE	285 max.	volts
PLATE DISSIPATION.	12 max.	watts
GRID-No.2 INPUT.	2 max.	watts
PEAK HEATER-CATHODE VOLTAGE:		
Heater negative with respect to cathode.	90 max.	volts
Heater positive with respect to cathode.	90 max.	volts
BULB TEMPERATURE (At hottest point on bulb surface)	250 max.	$^{\circ}$ C

Characteristics with 12.6 volts on heater:

Values are for 2 tubes

Plate Voltage.	250	volts
Grid-No.2 Voltage.	250	volts
Grid-No.1 (Control-Grid) Voltage	-15	volts
Peak Af Grid-No.1-to- Grid-No.1 Voltage	30	volts
Zero-Signal Plate Current.	70	ma
Max.-Signal Plate Current.	79	ma

- operation of heater in series with other heaters is not recommended.
- without external shield.

SEPT. 1, 1955

TUBE DIVISION

TENTATIVE DATA 1

RADIO CORPORATION OF AMERICA, HARRISON, NEW JERSEY



12AB5

12AB5

BEAM POWER TUBE

Zero-Signal Grid-No.2 Current (Approx.)	5	ma
Max.-Signal Grid-No.2 Current (Approx.)	13	ma
Effective Load Resistance (Plate to plate)	10000	ohms
Total Harmonic Distortion	5	%
Max.-Signal Power Output	10	watts

Maximum Circuit Values:

Grid-No.1-Circuit Resistance:

For fixed-bias operation	0.1 max.	megohm
For cathode-bias operation	0.5 max.	megohm

OPERATING CONSIDERATIONS

The *maximum ratings* in the tabulated data for the 12AB5 are working design-center maximums established according to the standard design-center system of rating electron tubes. Tubes so rated will give satisfactory performance in storage-battery-operated equipment provided the following stipulations are observed:

In the case of storage-battery-with-charger supply or similar supplies, the normal, battery-voltage fluctuation may be as much as 35 per cent or more. This fluctuation imposes severe operating conditions on tubes. Under these conditions, the equipment should be designed so that 90 per cent of the design-center maximum values of plate voltage, grid-No.2 voltage, plate dissipation, and grid-No.2 input is never exceeded for a battery terminal potential of 13.2 volts. Although the operating voltages of the 12AB5 in this service will, at times, exceed the design-center maximum values, satisfactory performance with probable sacrifice in life will be obtained.

12AB5



12AB5

AVERAGE CHARACTERISTICS

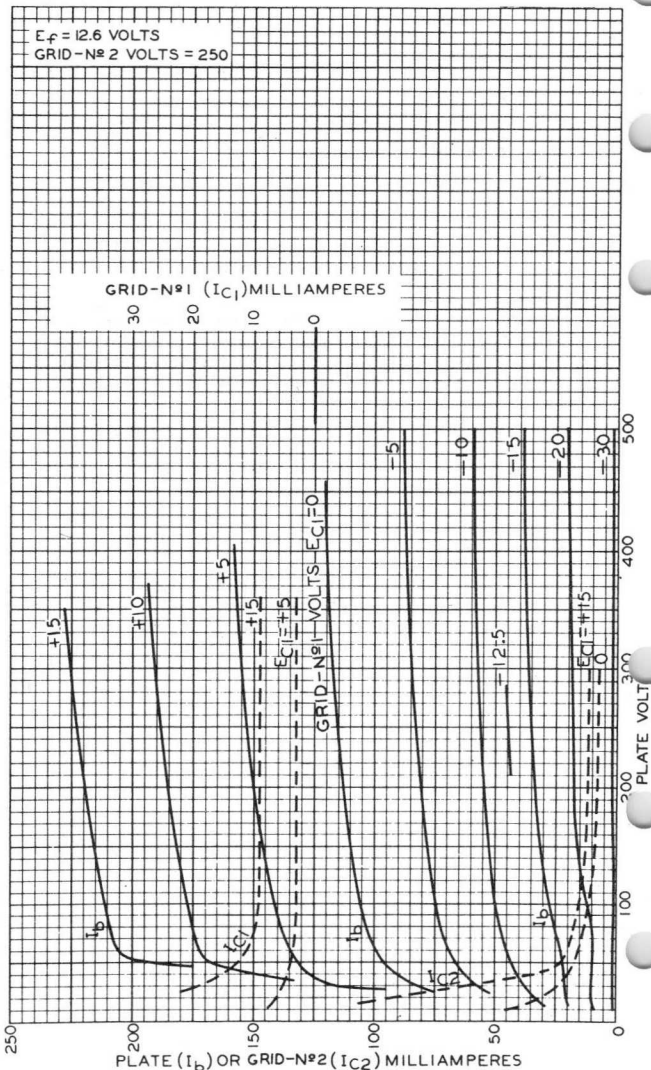

AUGUST 18, 1955

TUBE DIVISION

92CM-8754

RADIO CORPORATION OF AMERICA, HARRISON, NEW JERSEY



12AB5

AVERAGE CHARACTERISTICS TRIODE CONNECTION

12AB5

$E_f = 12.6$ VOLTS
GRID No2 CONNECTED TO PLATE

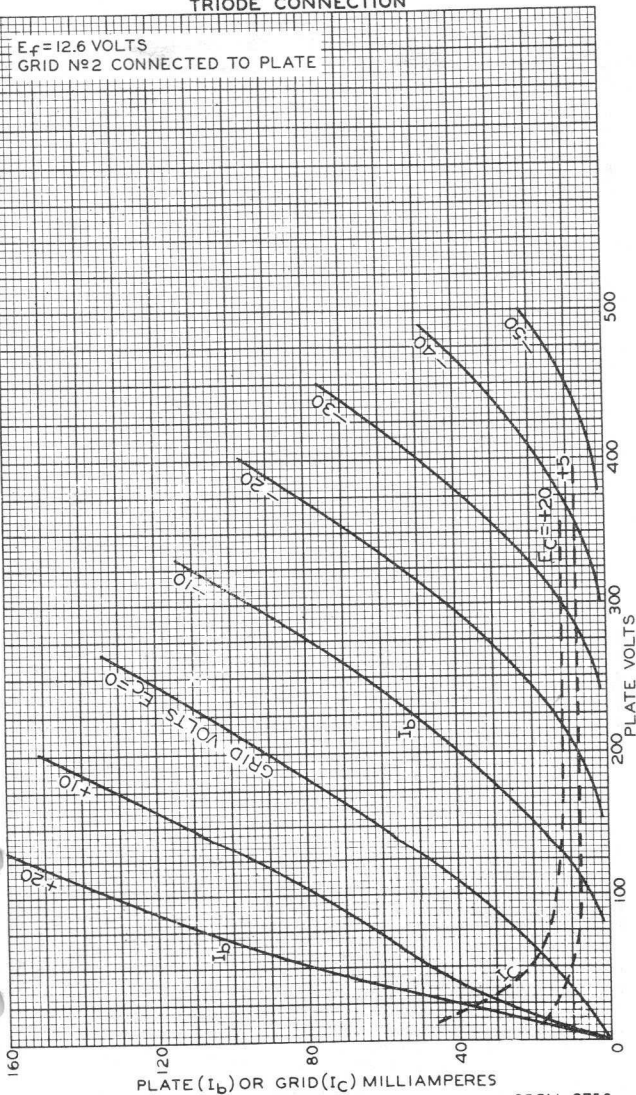

AUG. 19, 1955

PLATE (I_b) OR GRID (I_c) MILLIAMPERES

TUBE DIVISION

RADIO CORPORATION OF AMERICA, HARRISON, NEW JERSEY

92CM-8756

12AB5



12AB5

OPERATION CHARACTERISTICS

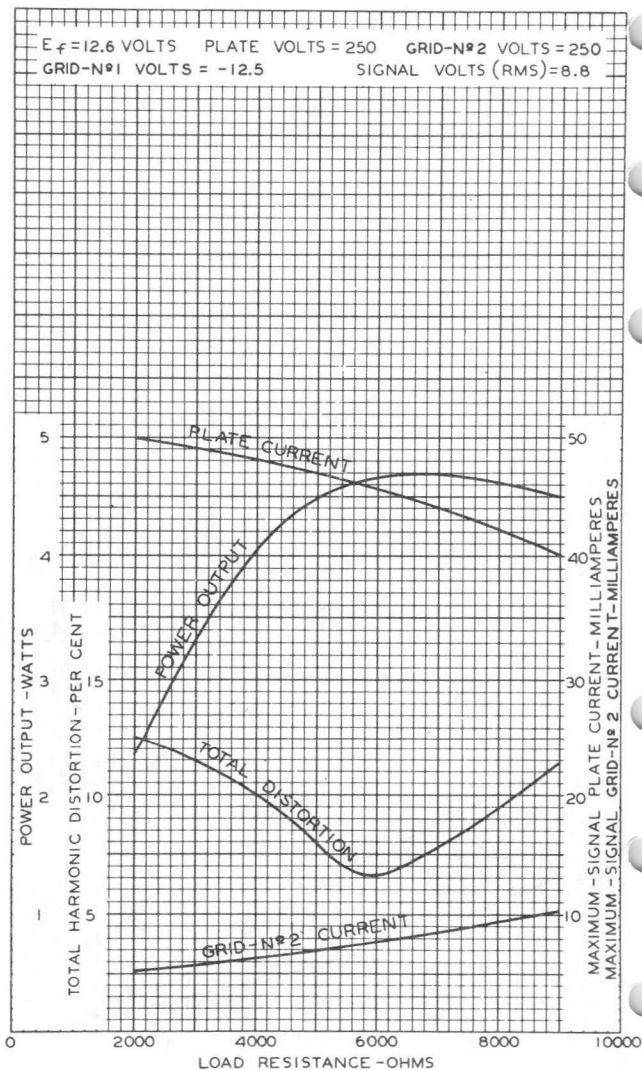

AUGUST 18, 1955

 TUBE DIVISION
 RADIO CORPORATION OF AMERICA, HARRISON, NEW JERSEY

92CM-8755



12AF3

12AF3 HALF-WAVE VACUUM RECTIFIER

9-PIN MINIATURE TYPE

*For damper service in TV receivers
having series heater-string arrangement*

The 12AF3 is the same as the 6AF3 except for the following items:

Heater, for Unipotential Cathode:

Voltage (AC or DC)	12.6	volts
Current	0.6 ± 6%	amp
Warm-up time (Average)	11	sec

1950





12AL5

TWIN DIODE

MINIATURE TYPE

12AL5

Heater, for Unipotential Cathodes:

Voltage 12.6 ac or dc volts
Current 0.15 amp

The 12AL5 is the same as the 6AL5 except for heater rating.

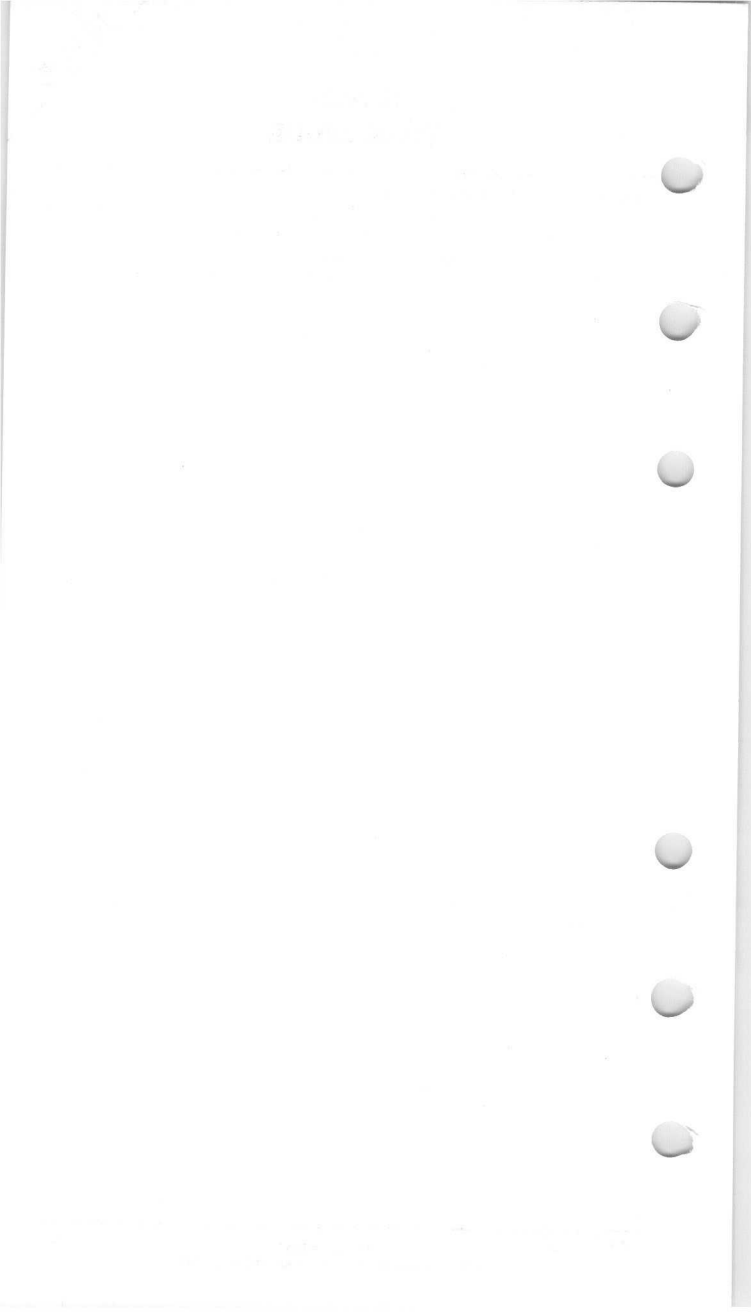

Beam Power Tube— Sharp-Cutoff Pentode

DUODECAR TYPE

The 12AL11 is the same as the 6AL11 except for the following items:

Heater Characteristics and Ratings:

Current.	0.450 ± 0.030	amp
Voltage (AC or DC) at heater amperes = 0.450.	12.6	volts
Warm-up time (Average)	11	sec







12AQ5

12AQ5

BEAM POWER AMPLIFIER

MINIATURE TYPE

GENERAL DATA

Electrical:

Heater, for Unipotential Cathode:

Voltage	12.6	ac or dc volts
Current	0.225	amp

Direct Interelectrode Capacitances

(Approx., without external shield):

Grid No.1 to Plate	0.35	$\mu\mu\text{f}$
Input	8.3	$\mu\mu\text{f}$
Output	8.2	$\mu\mu\text{f}$

Mechanical:

Mounting Position	Any
Maximum Overall Length	2-5/8"
Maximum Seated Length	2-3/8"
Length, Base Seat to Bulb Top (Excluding Tip)	2" \pm 3/32"
Maximum Diameter	3/4"
Bulb	T-5-1/2
Base	Small-Button Miniature 7-Pin (JETEC No.E7-1)

BOTTOM VIEW

Pin 1 - Grid No.1
 Pin 2 - Grid No.3,
 Cathode
 Pin 3 - Heater

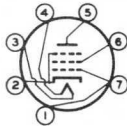

Pin 4 - Heater
 Pin 5 - Plate
 Pin 6 - Grid No.2
 Pin 7 - Grid No.1

AF POWER AMPLIFIER - Class A₁

Maximum Ratings, Design-Center Values:

PLATE VOLTAGE	250 max.	volts
GRID-NO.2 (SCREEN) VOLTAGE	250 max.	volts
PLATE DISSIPATION	12 max.	watts
GRID-NO.2 INPUT	2 max.	watts
PEAK HEATER-CATHODE VOLTAGE:		
Heater negative with respect to cathode	90 max.	volts
Heater positive with respect to cathode	90 max.	volts
BULB TEMPERATURE (At hottest point on bulb surface) *	250 max.	$^{\circ}\text{C}$

Typical Operation and Characteristics:

Plate Voltage	180	250	volts
Grid-No.2 Voltage	180	250	volts
Grid-No.1 (Control- Grid) Voltage	-8.5	-12.5	volts
Peak AF Grid-No.1 Voltage	8.5	12.5	volts
Zero-Signal Plate Current	29	45	ma
Max.-Signal Plate Current	30	47	ma

*: See next page.

12AQ5



12AQ5

BEAM POWER AMPLIFIER

Zero-Signal Grid-No.2 Current (Approx.)	3	4.5	ma
Max.-Signal Grid-No.2 Current (Approx.)	4	7	ma
Plate Resistance (Approx.)	58000	52000	ohms
Transconductance	3700	4100	μ hos
Load Resistance	5500	5000	ohms
Total Harmonic Distortion	8	8	per cent
Max.-Signal Power Output	2.0	4.5	watts

Maximum Circuit Values:

Grid-No.1-Circuit Resistance:

For fixed bias	0.1 max.	megohm
For cathode bias	0.5 max.	megohm

AF POWER AMPLIFIER - Class AB₁

Maximum Ratings, Design-Center Values:

PLATE VOLTAGE	250 max.	volts
GRID-No.2 (SCREEN) VOLTAGE	250 max.	volts
PLATE DISSIPATION	12 max.	watts
GRID-No.2 INPUT	2 max.	watts
PEAK HEATER-CATHODE VOLTAGE:		
Heater negative with respect to cathode	90 max.	volts
Heater positive with respect to cathode	90 max.	volts
BULB TEMPERATURE (At hottest point on bulb surface)*	250 max.	$^{\circ}$ C

Typical Operation:

Unless otherwise indicated, values are for 2 tubes

Plate Voltage	250	volts
Grid-No.2 Voltage	250	volts
Grid-No.1 (Control-Grid) Voltage#	-15	volts
Peak AF Grid-No.1-to-Grid-No.1 Voltage	30	volts
Zero-Signal Plate Current	70	ma
Max.-Signal Plate Current	79	ma
Zero-Signal Grid-No.2 Current (Approx.)	5	ma
Max.-Signal Grid-No.2 Current (Approx.)	13	ma
Plate Resistance (Approx. per tube)	60000	ohms
Transconductance (Per tube)	3750	μ hos
Effective Load Resistance (Plate to plate)	10000	ohms
Total Harmonic Distortion	5	per cent
Max.-Signal Power Output	10	watts

* High ambient temperature and shielding may necessitate a reduction in operating dissipation. When tube shields are used, it is advisable to paint the inside and outside surfaces of the tube shield a dull black and to provide ventilation slots to reduce operating temperature.

#: See next page.

AUG. 1, 1953

TUBE DEPARTMENT

TENTATIVE DATA 1

RADIO CORPORATION OF AMERICA, HARRISON, NEW JERSEY



12AQ5

12AQ5

BEAM POWER AMPLIFIER

Maximum Circuit Values Per Tube:▲

Grid-No.1-Circuit Resistance:§

For fixed bias	0.1 max.	megohm
For cathode bias	0.5 max.	megohm

§ The type of input coupling used should not introduce too much resistance in the grid-no.1 circuit. Transformer- or impedance-coupling devices are recommended.

▲ If the grid-no.1-circuit resistance is common to two tubes, the indicated maximum values per tube should be halved.

Curves shown under Type 6V6 also apply to 12AQ5

12AT6



12AT6
TWIN DIODE—HIGH-MU TRIODE
MINIATURE TYPE

Heater, for Unipotential Cathode:

Voltage 12.6 ac or dc volts
Current 0.15 amp

The 12AT6 is the same as the 6AT6 except for heater rating.



12AT7

12AT7

HIGH-MU TWIN TRIODE

9-PIN MINIATURE TYPE

GENERAL DATA

Electrical:

Heater, for Unipotential Cathodes:

Heater Arrangement	Series	Parallel	
Voltage	12.6	6.3	ac or dc volts
Current	0.15	0.3	amp

Direct Interelectrode Capacitances (Approx.)^o:

Unit No.1 Unit No.2

Grid-Drive Operation:

Grid to Plate	1.5	1.5	μμf
Grid to Cathode	2.2	2.2	μμf
Plate to Cathode	0.5	0.4	μμf
Heater to Cathode	2.4	2.4	μμf

Cathode-Drive Operation:

Plate to Cathode	0.2	0.2	μμf
Grid & Heater to Cathode	4.6	4.6	μμf
Grid & Heater to Plate	1.8	1.8	μμf
Grid to Grid	0.005 max.		μμf
Plate to Plate	0.4 max.		μμf

^o With no external shield.

Mechanical:

Mounting Position	Any
Maximum Overall Length	2-3/16"
Maximum Seated Length	1-15/16"
Length, Base Seat to Bulb Top (Excluding tip)	1-9/16" ± 3/32"
Maximum Diameter	7/8"
Bulb	T-6-1/2"
Base	Small-Button Noval 9 Pin (JEDEC No.E9-1)

Basing Designation for BOTTOM VIEW 9A

- Pin 1 - Plate of Unit No.2
- Pin 2 - Grid of Unit No.2
- Pin 3 - Cathode of Unit No.2
- Pin 4 - Heater
- Pin 5 - Heater

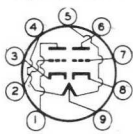

- Pin 6 - Plate of Unit No.1
- Pin 7 - Grid of Unit No.1
- Pin 8 - Cathode of Unit No.1
- Pin 9 - Heater Center-Tap

AMPLIFIER - Class A₁

Values are for each unit

Maximum Ratings, Design-Center Values:

PLATE VOLTAGE	300 max.	volts
GRID VOLTAGE:		
Negative Bias Value	-50 max.	volts
PLATE DISSIPATION	2.5 max.	watts

← Indicates a change

12AT7



12AT7

HIGH-MU TWIN TRIODE

PEAK HEATER-CATHODE VOLTAGE:

Heater negative with respect to cathode . . 90 max. volts
 Heater positive with respect to cathode . . 90 max. volts

→ Characteristics:

Plate Supply Voltage	100	250	volts
Cathode-Bias Resistor	270	200	ohms
Amplification Factor	60	60	
Plate Resistance (Approx.)	15000	10900	ohms
Transconductance	4000	5500	μmhos
Grid Voltage (Approx.)			
for plate current of 10 μamp . .	-5	-12	volts
Plate Current	3.7	10	ma

→ Indicates a change

MARCH 1, 1954

TUBE DEPARTMENT

DATA

RADIO CORPORATION OF AMERICA, HARRISON, NEW JERSEY



12AT7

12AT7 AVERAGE PLATE CHARACTERISTICS EACH UNIT

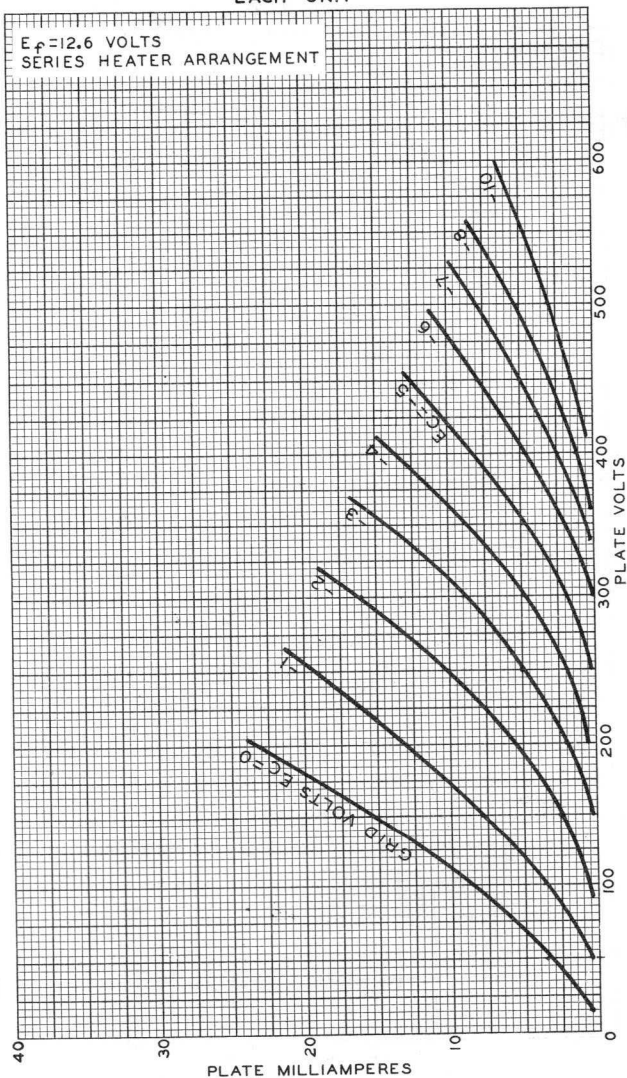

12AT7



12AT7

AVERAGE CHARACTERISTICS EACH UNIT

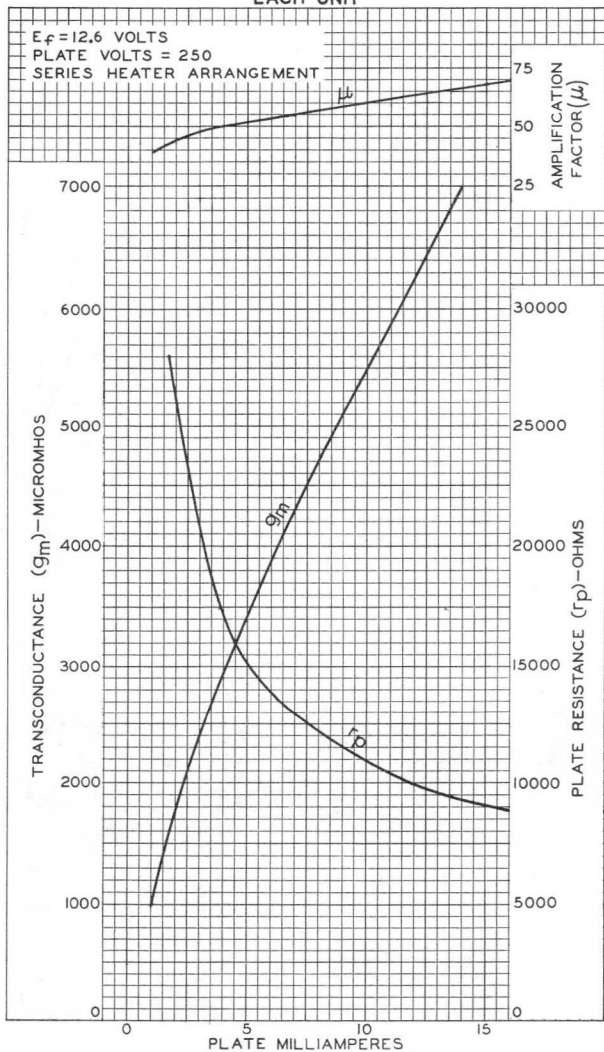



12AU6

12AU6

SHARP-CUTOFF PENTODE

7-PIN MINIATURE TYPE

The 12AU6 is the same as the 6AU6 except for the following items:

Heater, for Unipotential Cathode:

Voltage	12.6	ac or dc volts
Current	0.15	amp

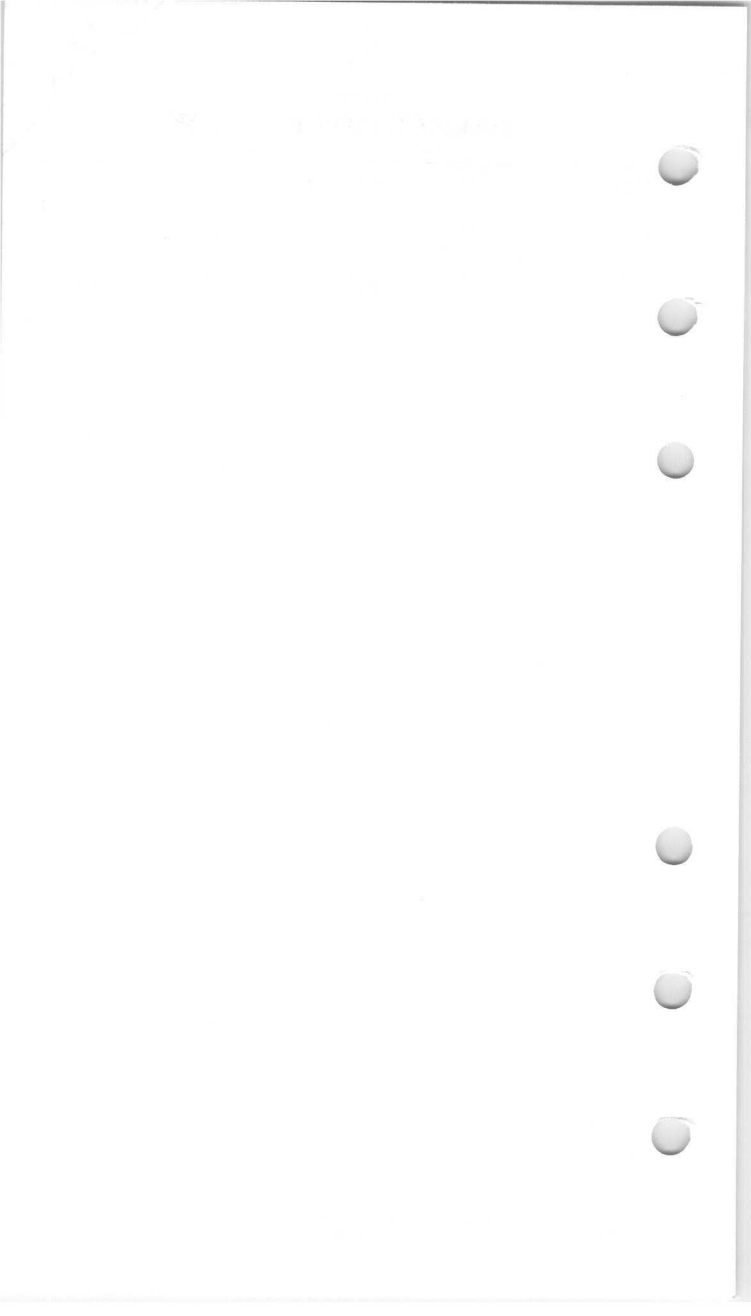

Medium-Mu Twin Triode

9-PIN MINIATURE TYPE

For Applications Critical as to Microphonics

GENERAL DATA

Electrical:

Heater, for Unipotential Cathodes:

Heater arrangement	Series	Parallel	
Voltage (AC or DC)	12.6	$6.3 \pm 10\%$	volts
Current	$0.15 \pm 6\%$	0.3	amp

Direct Interelectrode Capacitances (Approx.):^a

	Unit No.1	Unit No.2	
Grid to plate	1.5	1.5	$\mu\mu\text{f}$
Grid to cathode and heater. . .	1.6	1.6	$\mu\mu\text{f}$
Plate to cathode and heater . .	0.5	0.35	$\mu\mu\text{f}$

Characteristics, Class A₁ Amplifier (Each Unit):

Plate Voltage	100	250	volts
Grid Voltage.	0	-8.5	volts
Amplification Factor.	19.5	17	
Plate Resistance (Approx.) . . .	6250	7700	ohms
Transconductance.	3100	2200	μmhos
Plate Current	11.8	10.5	ma
Grid Voltage (Approx.) for plate $\mu\text{a} = 10$	-	-24	volts

Mechanical:

Operating Position.	Any
Maximum Overall Length.	2-3/16"
Maximum Seated Length	1-15/16"
Length, Base Seat to Bulb Top (Excluding tip). . .	1-9/16" \pm 3/32"
Diameter.	0.750" to 0.875"
Dimensional Outline	See <i>General Section</i>
Bulb.	T6-1/2
Base.	Small-Button Noval 9-Pin (JEDEC No.E9-1)
Basing Designation for BOTTOM VIEW.	9A

Pin 1-Plate of Unit No.2

Pin 2-Grid of Unit No.2

Pin 3-Cathode of Unit No.2

Pins 4 & 9-Heater of Unit No.2

Pins 5 & 9-Heater of Unit No.1

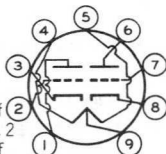

Pin 6-Plate of Unit No.1

Pin 7-Grid of Unit No.1

Pin 8-Cathode of Unit No.1

Pin 9-Heater Tap

← Indicates a change.



12AU7A

AMPLIFIER — Class A₁

Values are for Each Unit

→ Maximum Ratings, Design-Maximum Values:

PLATE VOLTAGE	330	max.	volts
CATHODE CURRENT	22	max.	ma
PLATE DISSIPATION:			
Either plate.	2.75	max.	watts
Both plates (Both units operating). . .	5.5	max.	watts
PEAK HEATER-CATHODE VOLTAGE:			
Heater negative with respect to cathode.	200	max.	volts
Heater positive with respect to cathode.	200 ^b	max.	volts

Typical Operation as Resistance-Coupled Amplifier:

See *RESISTANCE-COUPLED AMPLIFIER CHART No. 10*
at front of this Section

Maximum Circuit Values:

Grid-Circuit Resistance:			
For fixed-bias operation.	1	max.	megohm

HORIZONTAL-DEFLECTION OSCILLATOR

Values are for Each Unit

→ Maximum Ratings, Design-Maximum Values:

For operation in a 525-line, 30-frame system^c

DC PLATE VOLTAGE.	330	max.	volts
PEAK NEGATIVE-PULSE GRID VOLTAGE.	660	max.	volts
CATHODE CURRENT:			
Peak.	330	max.	ma
Average	22	max.	ma
PLATE DISSIPATION:			
Either plate.	2.75	max.	watts
Both plates (Both units operating). . .	5.5	max.	watts
PEAK HEATER-CATHODE VOLTAGE:			
Heater negative with respect to cathode.	200	max.	volts
Heater positive with respect to cathode.	200 ^b	max.	volts

Maximum Circuit Values:

Grid-Circuit Resistance	2.2	max.	megohms
-----------------------------------	-----	------	---------

VERTICAL-DEFLECTION OSCILLATOR

Values are for Each Unit

→ Maximum Ratings, Design-Maximum Values:

For operation in a 525-line, 30-frame system^c

DC PLATE VOLTAGE.	330	max.	volts
PEAK NEGATIVE-PULSE GRID VOLTAGE.	440	max.	volts
CATHODE CURRENT:			
Peak.	66	max.	ma
Average	22	max.	ma

→ Indicates a change.



PLATE DISSIPATION:

Either plate.	2.75	max.	watts
Both plates (Both units operating). . .	5.5	max.	watts

PEAK HEATER-CATHODE VOLTAGE:

Heater negative with respect to cathode.	200	max.	volts
Heater positive with respect to cathode.	200 ^b	max.	volts

Maximum Circuit Values:

Grid-Circuit Resistance	2.2	max.	megohms
-----------------------------------	-----	------	---------

VERTICAL-DEFLECTION AMPLIFIER

Values are for Each Unit

Maximum Ratings, Design-Maximum Values:

For operation in a 525-line, 30-frame system^c

DC PLATE VOLTAGE.	300	max.	volts
PEAK POSITIVE-PULSE PLATE VOLTAGE ^d	1200	max.	volts
PEAK NEGATIVE-PULSE GRID VOLTAGE.	275	max.	volts

CATHODE CURRENT:

Peak.	66	max.	ma
Average	22	max.	ma

PLATE DISSIPATION:

Either plate.	2.75	max.	watts
Both plates (Both units operating). . .	5.5	max.	watts

PEAK HEATER-CATHODE VOLTAGE:

Heater negative with respect to cathode.	200	max.	volts
Heater positive with respect to cathode.	200 ^b	max.	volts

Maximum Circuit Values:

Grid-Circuit Resistance:

For cathode-bias operation.	2.2	max.	megohms
-------------------------------------	-----	------	---------

^a Without external shield.

^b The dc component must not exceed 100 volts.

^c As described in "Standards of Good Engineering Practice Concerning Television Broadcast Stations," Federal Communications Commission.

^d This rating is applicable where the duration of the voltage pulse does not exceed 15 per cent of one vertical scanning cycle. In a 525-line, 30-frame system, 15 per cent of one vertical scanning cycle is 2.5 milliseconds.

← Indicates a change.



12AU7A

AVERAGE PLATE CHARACTERISTICS Each Unit

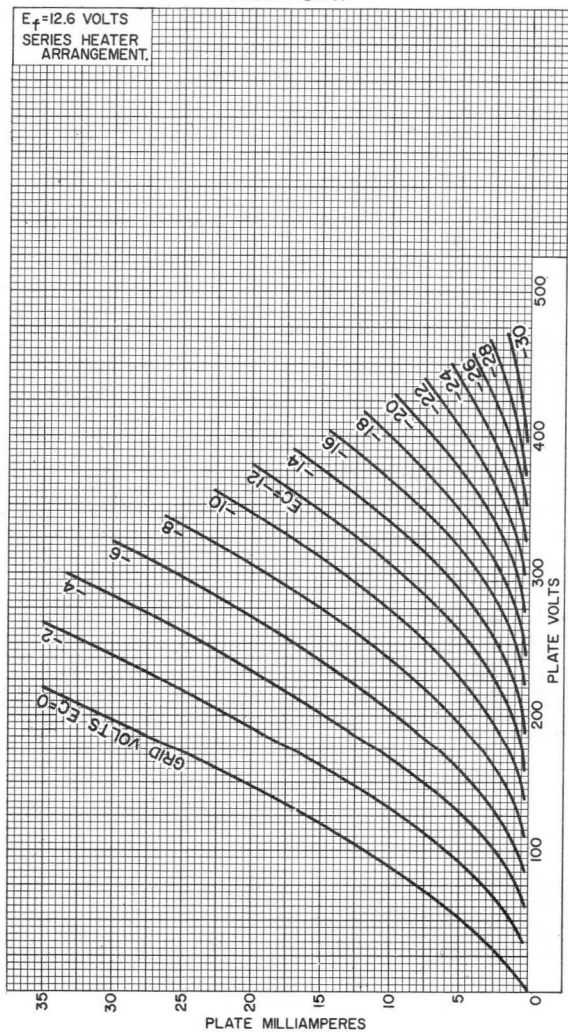

92CM-10548



AVERAGE CHARACTERISTICS Each Unit

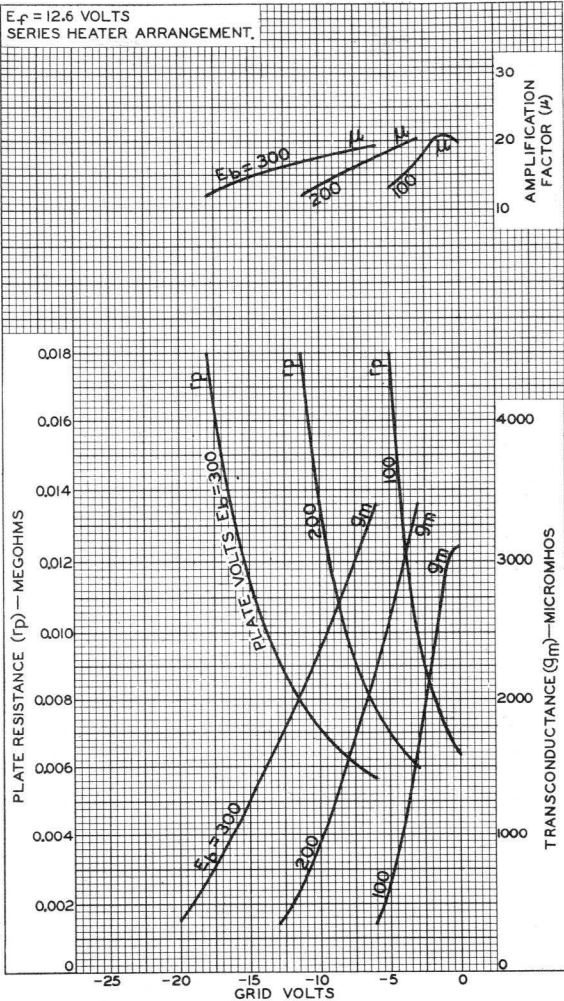

92CM-8564R2







12AV5-GA
12AV6

12AV5-GA BEAM POWER TUBE

*Intended for use in equipment having
series heater-string arrangement*

The 12AV5-GA is the same as the 6AV5-GA except for the following items:

Heater, for Unipotential Cathode:

Voltage	12.6	ac or dc volts
Current	0.6	amp
Warm-up time (Average) .	11	sec

For definition of heater warm-up time and method of determining it, see sheet HEATER WARM-UP TIME MEASUREMENT at front of this Section.

12AV6 TWIN DIODE—HIGH-MU TRIODE 7-PIN MINIATURE TYPE

The 12AV6 is the same as the 6AV6 except for the following items:

Heater, for Unipotential Cathode:

Voltage	12.6	ac or dc volts
Current	0.15	amp

NO. 10000
10000

ALL INFORMATION CONTAINED
HEREIN IS UNCLASSIFIED

DATE 10-10-2001 BY SP-6 [illegible]
[illegible text]

[illegible text]

Half-Wave Vacuum Rectifier

DUODECAR TYPE

With Heater Having Controlled Warm-Up Time

The 12AX3 is the same as the 6AX3 except for the following items:

Heater Characteristics and Ratings (*Design-Maximum Values*):

Voltage (AC or DC)	12.6 ^a	12.6 ± 1.2	volts
Current	0.600 ± 0.040	0.600 ^b	amp
Warm-up time (Average) . . .	11	-	sec

12AX4GTA

Half-Wave Vacuum Rectifier

For Damper Service in TV Equipment With
Heater Having Controlled Warm-Up Time

The 12AX4GTA is the same as the 6AX4GT except for the following items:

Heater Characteristics and Ratings (*Design-Maximum Values*):

Voltage (AC or DC)	12.6 ^a	12.6 ± 1.2	volts
Current	0.600 ± 0.040	0.600 ^b	amp
Warm-up time (Average) . . .	11	-	sec

12AX4GTB

Half-Wave Vacuum Rectifier

For Damper Service in TV Equipment With
Heater Having Controlled Warm-Up Time

The 12AX4GTB is the same as the 6AX4GTB except for the following items:

Heater Characteristics and Ratings (*Design-Maximum Values*):

Voltage (AC or DC)	12.6 ^a	12.6 ± 1.2	volts
Current	0.600 ± 0.040	0.600 ^b	amp
Warm-up time (Average) . . .	11	-	sec

^a At heater amperes = 0.600.

^b At heater volts = 12.6.





12AX7-A

High-Mu Twin Triode

9-PIN MINIATURE TYPE

For High-Fidelity Audio-Amplifier Applications Critical as to Noise and Hum

GENERAL DATA

Electrical:

Heater, for Unipotential Cathodes:

Heater arrangement	Series	Parallel	
Voltage (AC or DC)	12.6	6.3 ± 10%	volts
Current	0.15 ± 6%	0.3	amp

Direct Interelectrode Capacitances (Approx.):[▲]

	Unit No. 1	Unit No. 2	
Grid to plate	1.7	1.7	μf
Grid to cathode and heater . .	1.6	1.6	μf
Plate to cathode and heater . .	0.46	0.34	μf

Equivalent Noise and Hum Voltage (Referenced to Grid, Each Unit):

Average Value (RMS) 1.8 μvolts
Measured in "true rms" units under the following conditions: Heater volts (AC) = 6.3; center-tap of heater transformer connected to ground; plate supply volts (DC) = 250; plate load resistor (megohms) = 0.1; cathode resistor (ohms) = 2700; cathode bypass capacitor (μf) = 100; grid resistor (ohms) = 0; amplifier frequency range 25 to 10000 cps.

Characteristics, Class A₁ Amplifier (Each Unit):

Plate Voltage	100	250	volts
Grid Voltage	-1	-2	volts
Amplification Factor	100	100	
Plate Resistance (Approx.)	80000	62500	ohms
Transconductance	1250	1600	μhos
Plate Current	0.5	1.2	ma

Mechanical:

Operating Position Any
Maximum Overall Length 2-3/16"
Maximum Seated Length 1-15/16"
Length, Base Seat to Bulb Top (Excluding tip) 1-9/16" ± 3/32"
Diameter 0.750" to 0.875"
Dimensional Outline See General Section
Bulb T6-1/2
Base Small-Button Noval 9-Pin (JEDEC No. E9-1)



12AX7-A

Basing Designation for BOTTOM VIEW 9A

Pin 1 - Plate of
Unit No. 2

Pin 2 - Grid of
Unit No. 2

Pin 3 - Cathode of
Unit No. 2

Pins 4 & 9 - Heater of
Unit No. 2

Pins 5 & 9 - Heater of
Unit No. 1

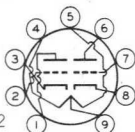

Pin 6 - Plate of
Unit No. 1

Pin 7 - Grid of
Unit No. 1

Pin 8 - Cathode of
Unit No. 1

Pin 9 - Heater Tap

AMPLIFIER — CLASS A₁

Values are for Each Unit

Maximum Ratings, Design-Maximum Values:

PLATE VOLTAGE.	330 max.	volts
GRID VOLTAGE:		
Negative-bias value.	55 max.	volts
Positive-bias value.	0 max.	volts
PLATE DISSIPATION.	1.2 max.	watts
PEAK HEATER-CATHODE VOLTAGE:		
Heater negative with respect to cathode.	200 max.	volts
Heater positive with respect to cathode.	200 [●] max.	volts

Typical Operation as Resistance-Coupled Amplifier:

See *RESISTANCE-COUPLED-AMPLIFIER CHART No. 25*
at front of this Section

[▲] Without external shield.

[●] The dc component must not exceed 100 volts.



12AX7-A

AVERAGE PLATE CHARACTERISTICS Each Unit

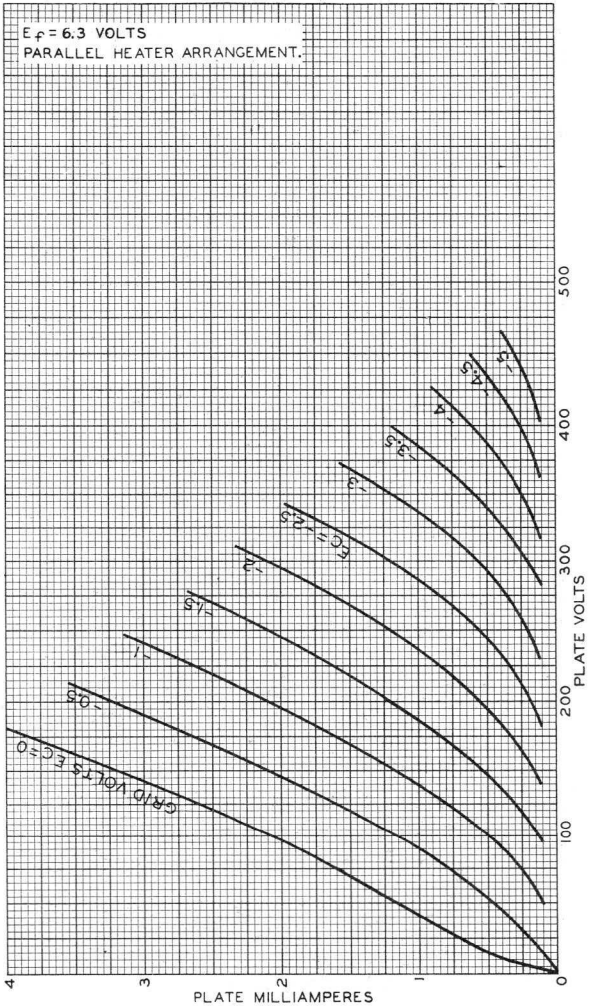

92CM-6879



RADIO CORPORATION OF AMERICA
Electron Tube Division
Harrison, N. J.

DATA 2
10-60

12AX7-A

AVERAGE CHARACTERISTICS Each Unit

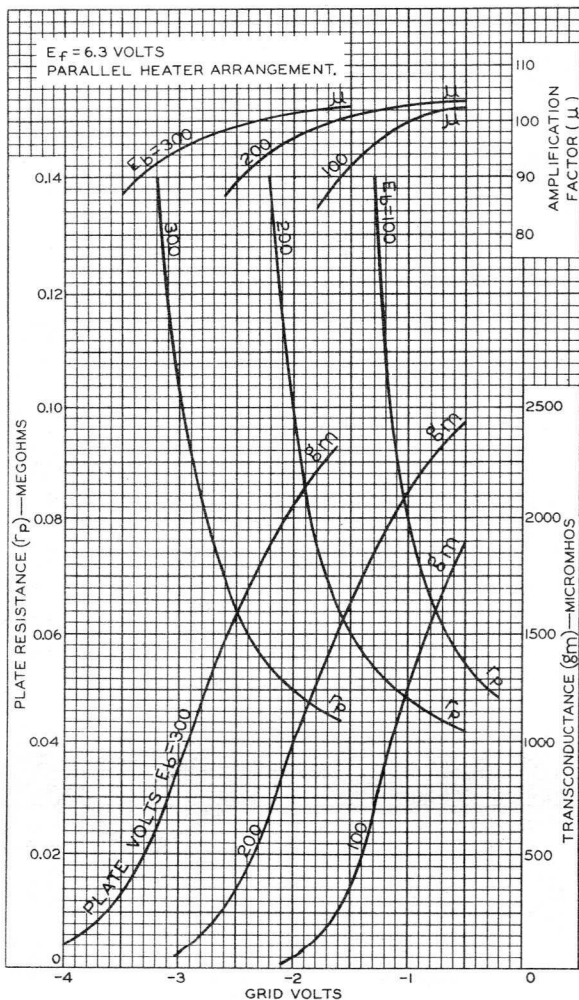

92CM-6880



12AY3

Half-Wave Vacuum Rectifier

NOVAR TYPE

For TV Damper Service

The 12AY3 is the same as the 6AY3 except for the following items:

Heater Characteristics and Ratings:

Current.	0.600 ± 0.040	amp
Voltage (AC or DC)	12.6	volts
Warm-up time (Average)	11	sec

12AY3A

Half-Wave Vacuum Rectifier

NOVAR TYPE

For TV Damper Service

The 12AY3A is the same as the 6AY3 B except for the following items:

Heater Characteristics and Ratings:

Current.	0.600 ± 0.040	amp
Voltage (AC or DC)	12.6	volts
Warm-up time (Average)	11	sec



RADIO CORPORATION OF AMERICA
Electronic Components and Devices Harrison, N. J.

DATA
10-64





12AY7

MEDIUM-MU TWIN TRIODE

MINIATURE TYPE

12AY7

GENERAL DATA

Electrical:

Heater, for Unipotential Cathodes:

Heater Arrangement	Series	Parallel
Voltage	12.6*	6.3 ac or dc volts
Current	0.15	0.3 amp

Direct Interelectrode Capacitances (Without External Shield)—Each Unit:

Grid to Plate	1.3 $\mu\mu\text{f}$
Input	1.3 $\mu\mu\text{f}$
Output	0.6 $\mu\mu\text{f}$

Characteristics, Class A₁ Amplifier (Each Unit):

Plate Voltage	250	volts
Grid Voltage	-4	volts
Amplification Factor	40	
Plate Resistance (Approx.)	22800	ohms
Transconductance	1750	μmhos
Plate Current	3	ma
Grid Voltage (Approx.) for plate current of 10 μamp	-11	volts

Mechanical:

Mounting Position	Any
Maximum Overall Length	2-3/16"
Maximum Seated Length	1-15/16"
Length, Base Seat to Bulb Top (Excluding tip)	1-9/16" \pm 3/32"
Maximum Diameter	7/8"
Bulb	T-6-1/2
Base	Small-Button Noval 9-Pin (JETEC No. E9-1)
Basing Designation for BOTTOM VIEW	9A

- Pin 1—Plate of Unit No.2
- Pin 2—Grid of Unit No.2
- Pin 3—Cathode of Unit No.2
- Pin 4—Heater
- Pin 5—Heater



- Pin 6—Plate of Unit No.1
- Pin 7—Grid of Unit No.1
- Pin 8—Cathode of Unit No.1
- Pin 9—Heater Mid-Tap

* use of the 12.6-volt connection with an ac-heater supply is not recommended for applications involving low hum.

(continued on next page)

12AY7



12AY7

MEDIUM-MU TWIN TRIODE

AMPLIFIER-Class A₁

Values are for each unit

Maximum Ratings, Design-Center Values:

PLATE VOLTAGE	300 max.	volts
GRID VOLTAGE:		
Negative bias value	50 max.	volts
Positive bias value	0 max.	volts
PLATE DISSIPATION	1.5 max.	watts
CATHODE CURRENT	10 max.	ma
PEAK HEATER-CATHODE VOLTAGE:		
Heater negative with respect to cathode	90 max.	volts
Heater positive with respect to cathode	90 max.	volts

Typical Operation as Resistance-Coupled Amplifier:

*See RESISTANCE-COUPLED AMPLIFIER CHART No.28
at front of Receiving Tube Section*



12AY7

12AY7

AVERAGE PLATE CHARACTERISTICS EACH UNIT

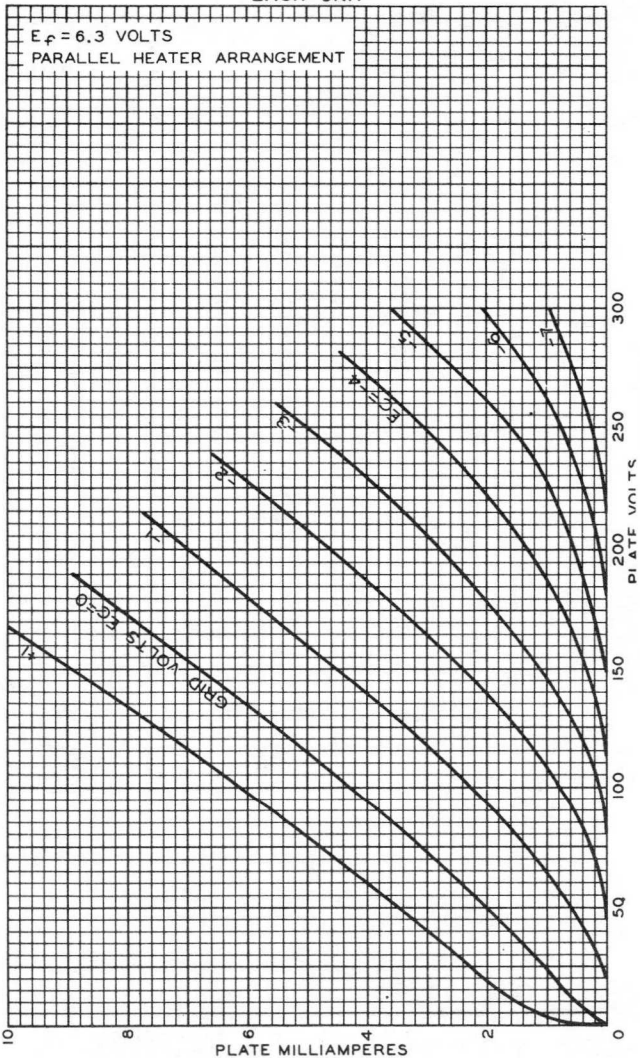

NOV. 5, 1952

TUBE DEPARTMENT
RADIO CORPORATION OF AMERICA, HARRISON, NEW JERSEY

92CM-7861

TYASI

AVERTONIA LATA LAMBERTIENSIS

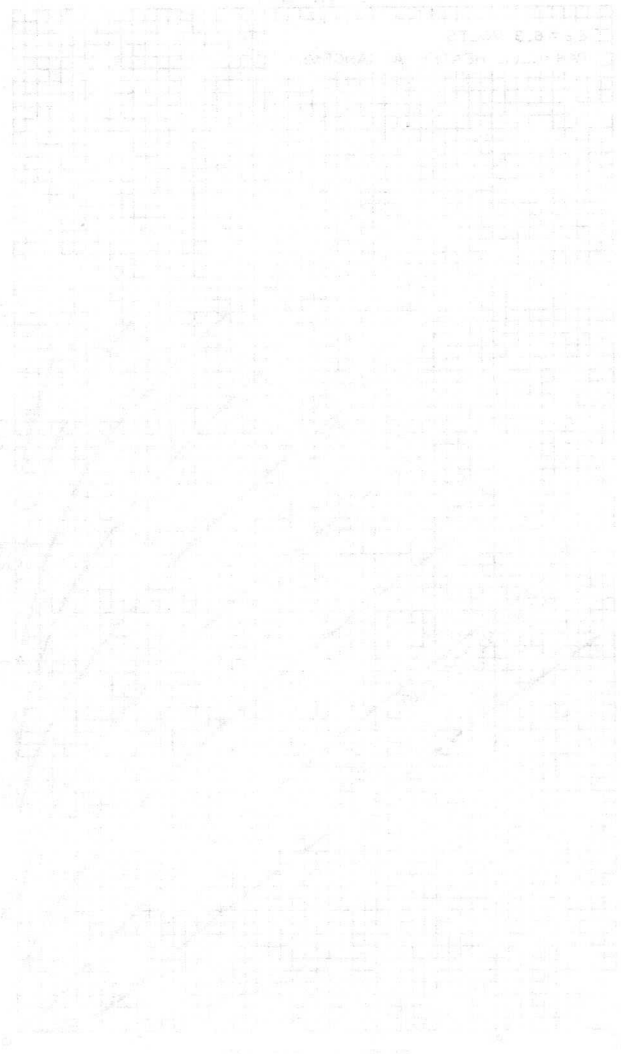

12AZ7A

High-Mu Twin Triode

9-PIN MINIATURE TYPE

With Heater Having Controlled Warm-Up Time

GENERAL DATA

Electrical:

Heater, for Unipotential Cathodes:

Heater arrangement	Series	Parallel	
Voltage (AC or DC)	12.6 ± 10%	6.3	volts
Current	0.225	0.45 ± 6%	amp
Warm-up time (Average)	-	11	sec

Direct Interelectrode Capacitances (Approx.):

	Without External Shield	With External Shield ^a	
<i>Unit No. 1:</i>			
Grid to plate	2	1.9	μf
Grid to cathode and heater	2.6	2.8	μf
Plate to cathode and heater	0.44	1.4	μf
<i>Unit No. 2:</i>			
Grid to plate	2	1.9	μf
Grid to cathode and heater	2.6	2.8	μf
Plate to cathode and heater	0.36	1.6	μf

Characteristics, Class A₁ Amplifier (Each Unit):

Plate Supply Voltage	100	250	volts
Cathode Resistor	270	200	ohms
Amplification Factor	60	60	
Plate Resistance (Approx.)	15000	10900	ohms
Transconductance	4000	5500	μmhos
Plate Current	3.7	10	ma
Grid Voltage (Approx.) for plate $\mu_a = 10$	-5	-12	volts

Mechanical:

Operating Position	Any
Maximum Overall Length	2-3/16"
Maximum Seated Length	1-15/16"
Length, Base Seat to Bulb Top (Excluding tip)	1-9/16" ± 3-32"
Diameter	0.750" to 0.875"
Dimensional Outline	See <i>General Section</i>
Bulb	T6-1/2
Base	Small-Button Noval 9-Pin (JEDEC No. E9-1)



12AZ7A

Basing Designation for BOTTOM VIEW. 9A

Pin 1 - Plate of
Unit No.2
Pin 2 - Grid of
Unit No.2
Pin 3 - Cathode of
Unit No.2
Pins 4 & 9 - Heater of
Unit No.2
Pins 5 & 9 - Heater of
Unit No.1

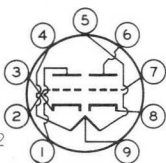

Pin 6 - Plate of
Unit No.1
Pin 7 - Grid of
Unit No.1
Pin 8 - Cathode of
Unit No.1
Pin 9 - Heater Tap

AMPLIFIER — Class A₁

Values are for Each Unit

Maximum Ratings, Design-Maximum Values:

PLATE VOLTAGE 330 max. volts
GRID VOLTAGE:
Negative-bias value 55 max. volts
PLATE DISSIPATION 2.5 max. watts
PEAK HEATER-CATHODE VOLTAGE:
Heater negative with respect to cathode. . 200 max. volts
Heater positive with respect to cathode. . 200^b max. volts

Maximum Circuit Values:

Grid-Circuit Resistance:
For fixed-bias operation. 0.25 max. megohm
For cathode-bias operation. 1 max. megohm

^a With external shield JEDEC No. 315 connected to cathode of unit under test.
^b The dc component must not exceed 100 volts.

CURVES

shown under Type 12AT7 also apply to the 12AZ7A





12B4-A

12B4-A LOW-MU TRIODE

9-PIN MINIATURE TYPE

*Intended for use in equipment having
series heater-string arrangement*

GENERAL DATA

Electrical:

Heater, for Unipotential Cathode:

Heater arrangement	Series	Parallel	
Voltage.	12.6	6.3	ac or dc volts
Current.	0.300	0.600	amp
Warm-up time (Average) .	-	11	sec

For definition of heater warm-up time and method of determining it, see sheet HEATER WARM-UP TIME MEASUREMENT at front of this Section.

Direct Interelectrode Capacitances (Approx.):⁰

Grid to plate.	4.8	$\mu\mu\text{f}$
Grid to cathode and heater	5	$\mu\mu\text{f}$
Plate to cathode and heater.	1.5	$\mu\mu\text{f}$

Characteristics, Class A₁ Amplifier:

Plate Voltage.	150	volts
Grid Voltage	-17.5	volts
Amplification Factor	6.5	
Plate Resistance (Approx.)	1030	ohms
Transconductance	6300	μmhos
Plate Current.	34	ma
Grid Voltage (Approx.) for plate current of 200 μamp	-32	volts
Plate Current for grid voltage of -23 volts	9.6	ma

Mechanical:

Mounting Position.	Any
Maximum Overall Length	2-5/8"
Maximum Seated Length.	2-3/8"
Length, Base Seat to Bulb Top (Excluding tip).	2" \pm 3/32"
Maximum Diameter	7/8"
Bulb	T-6-1/2
Base	Small-Button Noval 9-Pin (JETEC No. E9-1)
Basing Designation for BOTTOM VIEW	9AG

- Pin 1 - Cathode
- Pin 2 - Grid
- Pin 3 - Heater
Mid-Tap
- Pin 4 - Heater
- Pin 5 - Heater

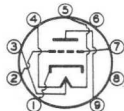

- Pin 6 - No Connection
- Pin 7 - Grid
- Pin 8 - No Connection
- Pin 9 - Plate

⁰ With external shield JETEC No. 315 connected to cathode.

MAY 1, 1955

TUBE DIVISION
RADIO CORPORATION OF AMERICA, HARRISON, NEW JERSEY

TENTATIVE DATA

12B4-A



12B4-A

LOW-MU TRIODE

AMPLIFIER - Class A₁

Maximum Ratings, Design-Center Values:

PLATE VOLTAGE.	550 max.	volts
GRID VOLTAGE:		
Negative bias value.	50 max.	volts
PLATE DISSIPATION.	5.5 max.	watts
PEAK HEATER-CATHODE VOLTAGE:		
Heater negative with respect to cathode	200 max.	volts
Heater positive with respect to cathode	200 [▲] max.	volts

Maximum Circuit Values:

Grid-Circuit Resistance:

For fixed-bias operation	0.47 max.	megohm
For cathode-bias operation	2.2 max.	megohms

VERTICAL DEFLECTION AMPLIFIER

Maximum Ratings, Design-Center Values Except as Noted:

For operation in a 525-line, 30-frame system[□]

DC PLATE VOLTAGE	550 max.	volts
PEAK POSITIVE-PULSE PLATE VOLTAGE (Absolute maximum) [#]	1000 [■] max.	volts
PEAK NEGATIVE-PULSE GRID VOLTAGE	250 max.	volts
CATHODE CURRENT:		
Peak	105 max.	ma
Average	30 max.	ma
PLATE DISSIPATION.	5.5 max.	watts
PEAK HEATER-CATHODE VOLTAGE:		
Heater negative with respect to cathode	200 max.	volts
Heater negative with respect to cathode	200 [▲] max.	volts

Maximum Circuit Values:

Grid-Circuit Resistance:

For cathode-bias operation	2.2 max.	megohms
--------------------------------------	----------	---------

[▲] The dc component must not exceed 100 volts.[□] As described in "Standards of Good Engineering Practice Concerning Television Broadcast Stations", Federal Communications Commission.[#] This rating is applicable where the duration of the voltage pulse does not exceed 15 per cent. of one vertical scanning cycle. In a 525-line, 30-frame system, 15 per cent. of one vertical scanning cycle is 2.5 milliseconds.[■] Under no circumstances should this absolute value be exceeded.

MAY 1, 1955

TUBE DIVISION

TENTATIVE DATA

RADIO CORPORATION OF AMERICA, HARRISON, NEW JERSEY

12BA6

Remote-Cutoff Pentode

7-PIN MINIATURE TYPE

The 12BA6 is the same as the 6BA6 except for the following items:

Heater Characteristics and Ratings

Voltage (AC or DC)	12.6 V
Current	0.150 A

12BA7

Pentagrid Converter

9-PIN MINIATURE TYPE

The 12BA7 is the same as the 6BA7 except for the following items:

Heater Characteristics and Ratings

Voltage (AC or DC)	12.6 V
Current	0.150 A

12BD6

Remote-Cutoff Pentode

7-PIN MINIATURE TYPE

The 12BD6 is the same as the 6BD6 except for the following items:

Heater Characteristics and Ratings

Voltage (AC or DC)	12.6 V
Current	0.150 A



12BE3

Half-Wave Vacuum Rectifier

DUODECAR TYPE

The 12BE3 is the same as the 6BE3 except for the following items:

Heater Characteristics and Ratings

Current.	0.600 ± 0.040	A
Voltage (AC or DC) at 0.600 A.	12.6	V
Warm-up time (Average)	11	s

12BE6

Pentagrid Converter

7-PIN MINIATURE TYPE

The 12BE6 is the same as the 6BE6 except for the following items:

Heater Characteristics and Ratings

Voltage (AC or DC)	12.6	V
Current.	0.150	A

12BF6

Twin Diode—Medium-Mu Triode

7-PIN MINIATURE TYPE

The 12BF6 is the same as the 6BF6 except for the following items:

Heater Characteristics and Ratings

Voltage (AC or DC)	12.6	V
Current.	0.150	A

12BF11

Dual Control Sharp-Cutoff Pentode— Beam Power Tube

DUODECAR TYPE

The 12BF11 is the same as the 6BF11 except for the following items:

Heater Characteristics and Ratings

Current.	0.600 ± 0.040	A
Voltage (AC or DC) at 0.600 A.	12.6	V
Warm-up time (Average)	11	s





12BH7-A

12BH7-A MEDIUM-MU TWIN TRIODE

9-PIN MINIATURE TYPE

*Intended for use in equipment having
series heater-string arrangement*

GENERAL DATA

Electrical:

Heater, for Unipotential Cathodes:

Heater arrangement	Series	Parallel	
Voltage	12.6	6.3	ac or dc volts
Current	0.3	0.6	amp
Warm-up time (Average)	—	11	sec

For definition of heater warm-up time and method of determining it, see sheet HEATER WARM-UP TIME MEASUREMENT at front of this Section.

Direct Interelectrode Capacitances (Approx.):^o

	Unit No.1	Unit No.2	
Grid to plate	2.6	2.6	$\mu\mu\text{f}$
Grid to cathode and heater	3.2	3.2	$\mu\mu\text{f}$
Plate to cathode and heater	0.5	0.4	$\mu\mu\text{f}$
Plate of unit No.1 to plate of unit No.2	0.8		$\mu\mu\text{f}$

Mechanical:

- Mounting Position Any
- Maximum Overall Length 2-5/8"
- Maximum Seated Length 2-3/8"
- Length, Base Seat to Bulb Top (Excluding tip) . . . 2" \pm 3/32"
- Maximum Diameter 7/8"
- Bulb T-6-1/2
- Base Small-Button Noval 9-Pin (JETEC No.E9-1)

Basing Designation for BOTTOM VIEW 9A	
Pin 1 - Plate of Unit No.2	Pin 6 - Plate of Unit No.1
Pin 2 - Grid of Unit No.2	Pin 7 - Grid of Unit No.1
Pin 3 - Cathode of Unit No.2	Pin 8 - Cathode of Unit No.1
Pins 4 & 9 - Heater of Unit No.2	Pin 9 - Heater Mid-Tap
Pins 5 & 9 - Heater of Unit No.1	

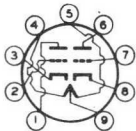

AMPLIFIER - Class A₁

Values are for Each Unit

Maximum Ratings, Design-Center Values:

PLATE VOLTAGE 300 max. volts

^o Without external shield.

12BH7-A



12BH7-A

MEDIUM-MU TWIN TRIODE

GRID VOLTAGE:

Negative bias value 50 max. volts
 Positive bias value 0 max. volts

CATHODE CURRENT 20 max. ma

PLATE DISSIPATION 3.5 max. watts

PEAK HEATER-CATHODE VOLTAGE:

Heater negative with respect to cathode 200 max. volts
 Heater positive with respect to cathode 200[▲]max. volts

Characteristics:

Plate Voltage 250 volts

Grid Voltage -10.5 volts

Amplification Factor 16.5

Plate Resistance (Approx.) 5300 ohms

Transconductance 3100 μ hos

Plate Current 11.5 ma

Plate Current for grid
 voltage of -14 volts 4 ma

Grid Voltage (Approx.) for
 plate current of 50 μ amp -23 volts

Maximum Circuit Values:

Grid-Circuit Resistance:

For fixed-bias operation 0.25 max. megohm
 For cathode-bias operation 1.0 max. megohm

HORIZONTAL DEFLECTION OSCILLATOR

Values are for Each Unit

Maximum Ratings, Design-Center Values:

For operation in a 525-line, 30-frame system[□]

DC PLATE VOLTAGE 450 max. volts

PEAK NEGATIVE-PULSE GRID VOLTAGE[♣] 600 max. volts

CATHODE CURRENT:

Peak 300 max. ma

Average 20 max. ma

PLATE DISSIPATION 3.5 max. watts

PEAK HEATER-CATHODE VOLTAGE:

Heater negative with respect to cathode 200 max. volts

Heater positive with respect to cathode 200[▲]max. volts

Maximum Circuit Values:

Grid-Circuit Resistance:

For fixed-bias, grid-resistor bias, or
 cathode-bias operation 2.2 max. megohms

[♣] This rating is applicable where the duration of the voltage pulse does not exceed 15 per cent of one horizontal scanning cycle. In a 525-line, 30-frame system, 15 per cent of one horizontal scanning cycle is 10 microseconds.

[▲], [□]: See next page.

MAR. 1, 1955

TUBE DIVISION

TENTATIVE DATA 1

RADIO CORPORATION OF AMERICA, HARRISON, NEW JERSEY



12BH7-A

12BH7-A

MEDIUM-MU TWIN TRIODE

VERTICAL DEFLECTION OSCILLATOR

Values are for Each Unit

Maximum Ratings, Design-Center Values:

For operation in a 525-line, 30-frame system[□]

DC PLATE VOLTAGE	450 max.	volts
PEAK NEGATIVE-PULSE GRID VOLTAGE	400 max.	volts
CATHODE CURRENT:		
Peak	70 max.	ma
Average.	20 max.	ma
PLATE DISSIPATION.	3.5 max.	watts
PEAK HEATER-CATHODE VOLTAGE:		
Heater negative with respect to cathode.	200 max.	volts
Heater positive with respect to cathode.	200 [▲] max.	volts

Maximum Circuit Values:

Grid-Circuit Resistance:
 For fixed-bias, grid-resistor bias, or
 cathode-bias operation 2.2 max. megohms

VERTICAL DEFLECTION AMPLIFIER

Values are for Each Unit

Maximum Ratings, Design-Center Values Except as Noted:

For operation in a 525-line, 30-frame system[□]

DC PLATE VOLTAGE	450 max.	volts
PEAK POSITIVE-PULSE PLATE VOLTAGE [#] (Absolute Maximum)	1500 [■] max.	volts
PEAK NEGATIVE-PULSE GRID VOLTAGE	250 max.	volts
CATHODE CURRENT:		
Peak	70 max.	ma
Average.	20 max.	ma
PLATE DISSIPATION.	3.5 max.	watts
PEAK HEATER-CATHODE VOLTAGE:		
Heater negative with respect to cathode.	200 max.	volts
Heater positive with respect to cathode.	200 [▲] max.	volts

Maximum Circuit Values:

Grid-Circuit Resistance:
 For cathode-bias operation 2.2 max. megohms

- ▲ The dc component must not exceed 100 volts.
- As described in "Standards of Good Engineering Practice Concerning Television Broadcast Stations", Federal Communications Commission.
- # This rating is applicable where the duration of the voltage pulse does not exceed 15 per cent of one vertical scanning cycle. In a 525-line, 30-frame system, 15 per cent of one vertical scanning cycle is 2.5 milliseconds.
- Under no circumstances should this absolute value be exceeded.

12BH7-A



12BH7-A

AVERAGE PLATE CHARACTERISTICS
EACH TRIODE UNIT

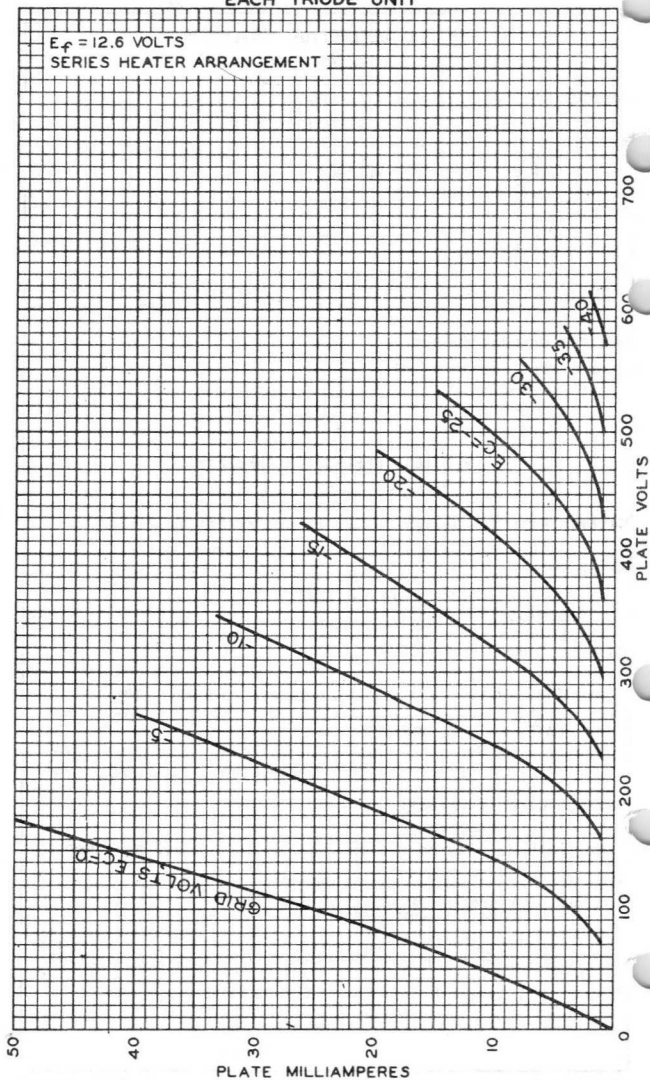

MAR. 1, 1955

PLATE MILLIAMPERES
TUBE DIVISION
RADIO CORPORATION OF AMERICA, HARRISON, NEW JERSEY

92CM-774 2RI

12BQ6GTB/12CU6

Beam Power Tube

The 12BQ6GTB/12CU6 is the same as the 6BQ6GTB/6CU6 except for the following items:

Heater Characteristics and Ratings:

Current	0.600 ± 0.040	amp
Voltage (AC or DC) at heater amperes = 0.600	12.6	volts
Warm-up time (Average)	11	sec

12BS3

Half-Wave Vacuum Rectifier

NOVAR TYPE

For TV Damper Service

The 12BS3 is the same as the 6BS3 except for the following items:

Heater Characteristics and Ratings:

Current	0.600 ± 0.040	amp
Voltage (AC or DC) at heater amperes = 0.600	12.6	volts
Warm-up time (Average)	11	sec

12BS3A

Half-Wave Vacuum Rectifier

NOVAR TYPE

For TV Damper Service

The 12BS3A is the same as the 6BS3A except for the following items:

Heater Characteristics and Ratings:

Current	0.600 ± 0.040	amp
Voltage (AC or DC) at heater amperes = 0.600	12.6	volts
Warm-up time (Average)	11	sec





Sharp-Cutoff Pentode

9-PIN MINIATURE TYPE

For Equipment Having Series Heater-String Arrangement

GENERAL DATA

Electrical:

Heater, for Unipotential Cathode:

	Series	Parallel	
Heater arrangement			
Voltage (AC or DC)	12.6 ± 10%	6.3	volts
Current	0.3	0.6 ± 6%	amp
Warm-up time (Average)	-	11	sec

Direct Interelectrode Capacitances:^a

Grid No.1 to plate.	0.063	μf
Grid No.1 to cathode, grid No.3 & internal shield, grid No.2, and heater.	10.2	μf
Plate to cathode, grid No.3 & internal shield, grid No.2, and heater.	3.5	μf

Characteristics, Class A₁ Amplifier:

Plate Supply Voltage.	250	volts
Grid No.3	<i>Connected to cathode at socket</i>	
Grid-No.2 Supply Voltage.	180	volts
Cathode Resistor.	100	ohms
Plate Resistance (Approx.)	93000	ohms
Transconductance.	11000	μmhos
Plate Current	26	ma
Grid-No.2 Current	5.75	ma
Grid-No.1 Voltage (Approx.) for plate $\mu a = 20$	-11.6	volts

Mechanical:

Operating Position.	Any
Maximum Overall Length.	2-5/8"
Maximum Seated Length	2-3/8"
Length, Base Seat to Bulb Top (Excluding tip)	2" ± 3/32"
Diameter.	0.750" to 0.875"
Dimensional Outline	See <i>General Section</i>
Bulb.T6-1/2
Base.	Small-Button Noval 9-Pin (JEDEC No.E9-1)
Basing Designation for BOTTOM VIEW.	9BF

- Pin 1 - Cathode
- Pin 2 - Grid No.1
- Pin 3 - Grid No.3, Internal Shield
- Pin 4 - Heater
- Pin 5 - Heater

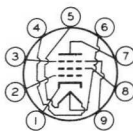

- Pin 6 - Heater Tap
- Pin 7 - Plate
- Pin 8 - Grid No.2
- Pin 9 - Grid No.3, Internal Shield

← Indicates a change.



12BY7-A

AMPLIFIER — Class A₁

Maximum Ratings, Design-Maximum Values:

PLATE VOLTAGE	330 max.	volts
GRID No.3 (SUPPRESSOR GRID)Connect to cathode at socket	
GRID-No.2 (SCREEN-GRID) VOLTAGE	190 max.	volts
GRID-No.1 (CONTROL-GRID) VOLTAGE:		
Negative-bias value	55 max.	volts
Positive-bias value	0 max.	volts
GRID-No.2 INPUT	1.2 max.	watts
PLATE DISSIPATION	6.5 max.	watts
PEAK HEATER-CATHODE VOLTAGE:		
Heater negative with respect to cathode.	200 max.	volts
Heater positive with respect to cathode.	200 ^b max.	volts

Maximum Circuit Values:

Grid-No.1-Circuit Resistance:		
For fixed-bias operation.	0.25 max.	megohm
For cathode-bias operation.	1 max.	megohm

^a Without external shield.

^b The dc component must not exceed 100 volts.

→ Indicates a change.



AVERAGE PLATE CHARACTERISTICS

$E_f = 12.6$ VOLTS
 SERIES HEATER ARRANGEMENT.
 GRID No.3 CONNECTED TO CATHODE
 AT SOCKET.
 GRID-No.2 VOLTS = 180

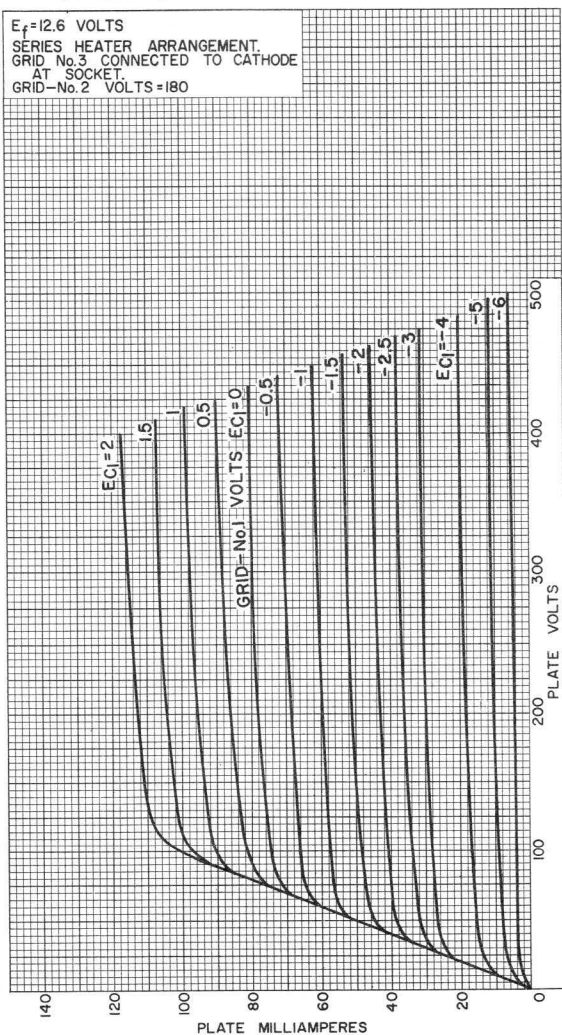

92CM-9234R2



12BY7-A

AVERAGE CHARACTERISTICS

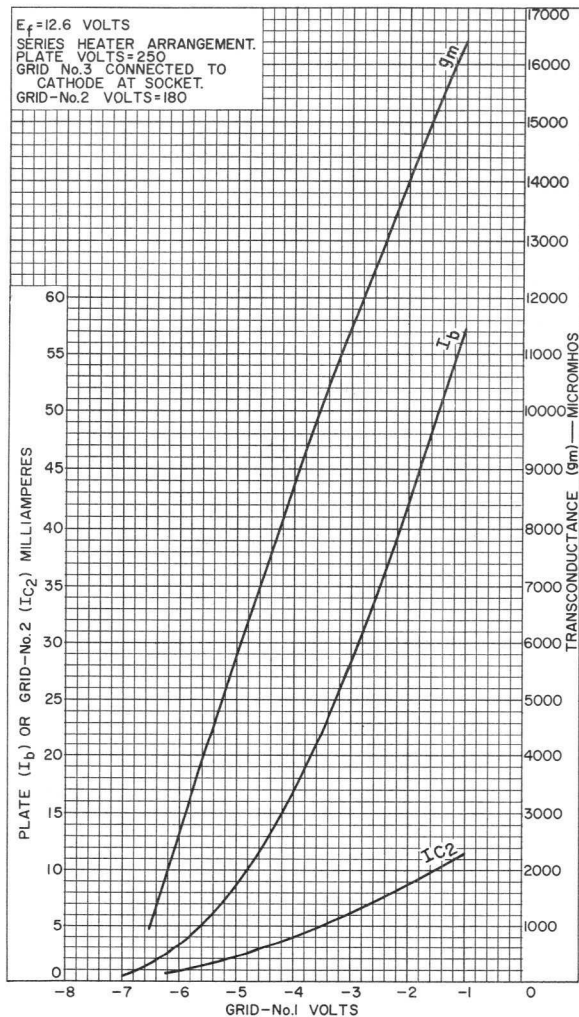

92CM-11051



Semiremote-Cutoff Pentode

7-PIN MINIATURE TYPE

The 12BZ6 is the same as the 6BZ6 except for the following items:

Heater, for Unipotential Cathode:

Voltage (AC or DC)	12.6 ± 10%	volts
Current	0.15	amp







12CA5

12CA5

BEAM POWER TUBE

MINIATURE TYPE

Intended for use in equipment having series heater-string arrangement

GENERAL DATA

Electrical:

Heater, for Unipotential Cathode:

Voltage	12.6	ac or dc volts
Current	0.6	amp
Warm-up time (Average)	11	sec

For definition of heater warm-up time and method of determining it, see sheet HEATER WARM-UP TIME MEASUREMENT at front of this Section.

Direct Interelectrode Capacitances (Approx.):^o

Grid No.1 to plate	0.5	μf
Grid No.1 to cathode & grid No.3, grid No.2, and heater.	15	μf
Plate to cathode & grid No.3, grid No.2, and heater.	9	μf

Mechanical:

Mounting Position	Any
Maximum Overall Length	2-5/8"
Maximum Seated Length	2-3/8"
Length, Base Seat to Bulb Top (Excluding tip)	2" ± 3/32"
Maximum Diameter	3/4"
Bulb	T-5-1/2
Base	Small-Button Miniature 7-Pin (JETEC No.E7-1)
Basing Designation for BOTTOM VIEW7CV

Pin 1 - Cathode,
Grid No.3
Pin 2 - Grid No.1
Pin 3 - Heater

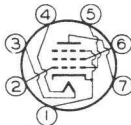

Pin 4 - Heater
Pin 5 - Grid No.1
Pin 6 - Grid No.2
Pin 7 - Plate

AMPLIFIER - Class A₁

Maximum Ratings, Design-Center Values:

PLATE VOLTAGE	130 max.	volts
GRID-No.2 (SCREEN) VOLTAGE	130 max.	volts
GRID-No.1 (CONTROL-GRID) VOLTAGE:		
Positive bias value	0 max.	volts
PLATE DISSIPATION	5 max.	watts
GRID-No.2 INPUT	1.4 max.	watts
PEAK HEATER-CATHODE VOLTAGE:		
Heater negative with respect to cathode.	200 max.	volts
Heater positive with respect to cathode.	200 [▲] max.	volts
BULB TEMPERATURE (At hottest point on bulb surface)	180 max.	°C

^o without external shield.

[▲] The dc component must not exceed 100 volts.

12CA5



12CA5

BEAM POWER TUBE

Typical Operation and Characteristics:

Plate Voltage.	110	125	volts
Grid-No.2 Voltage.	110	125	volts
Grid-No.1 Voltage.	-4	-4.5	volts
Peak AF Grid-No.1 Voltage.	4	4.5	volts
Zero-Signal Plate Current.	32	37	ma
Max.-Signal Plate Current.	31	36	ma
Zero-Signal Grid-No.2 Current.	3.5	4	ma
Max.-Signal Grid-No.2 Current.	7.5	11	ma
Plate Resistance (Approx.)	16000	15000	ohms
Transconductance	8100	9200	μmhos
Load Resistance.	3500	4500	ohms
Total Harmonic Distortion.	5	6	%
Max.-Signal Power Output	1.1	1.5	watts

Maximum Circuit Values:

Grid-No.1-Circuit Resistance:			
For fixed-bias operation		0.1 max.	megohm
For cathode-bias operation		0.5 max.	megohm



12CA5

12CA5

AVERAGE PLATE CHARACTERISTICS

$E_f = 12.6$ VOLTS GRID-N \circ 2 VOLTS = 125

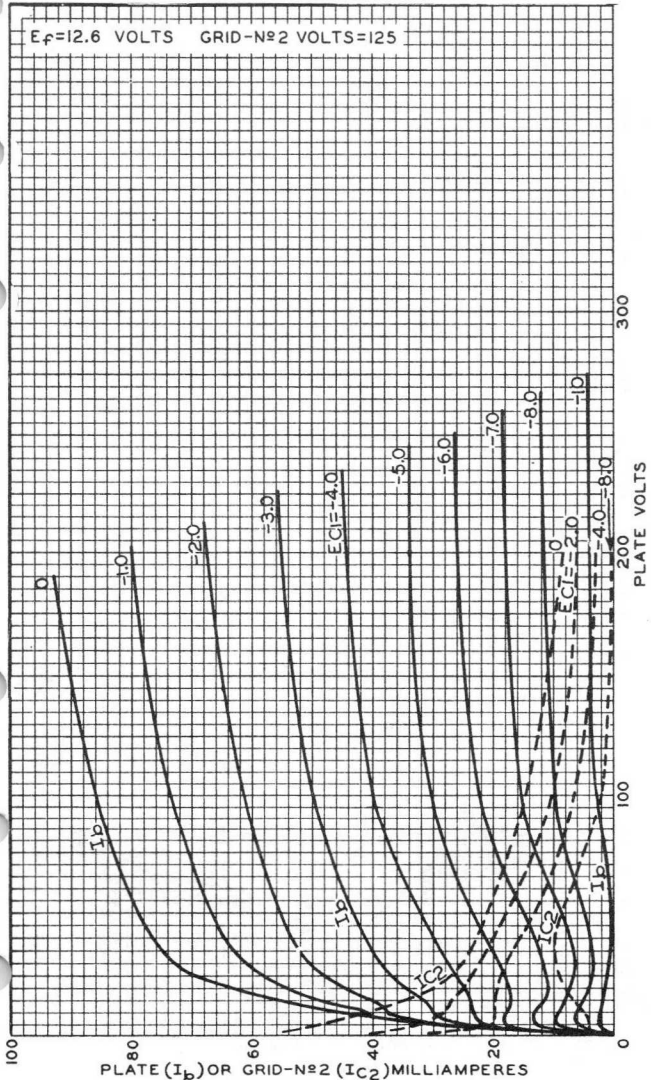

JAN. 24, 1955

TUBE DIVISION

92CM-8507

RADIO CORPORATION OF AMERICA, HARRISON, NEW JERSEY

12CA5



12CA5

OPERATION CHARACTERISTICS

$E_f = 12.6$ VOLTS PLATE VOLTS = 125 GRID-N^o2 VOLTS = 125
GRID-N^o1 VOLTS = -4.5 SIGNAL VOLTS (RMS) = 3.2

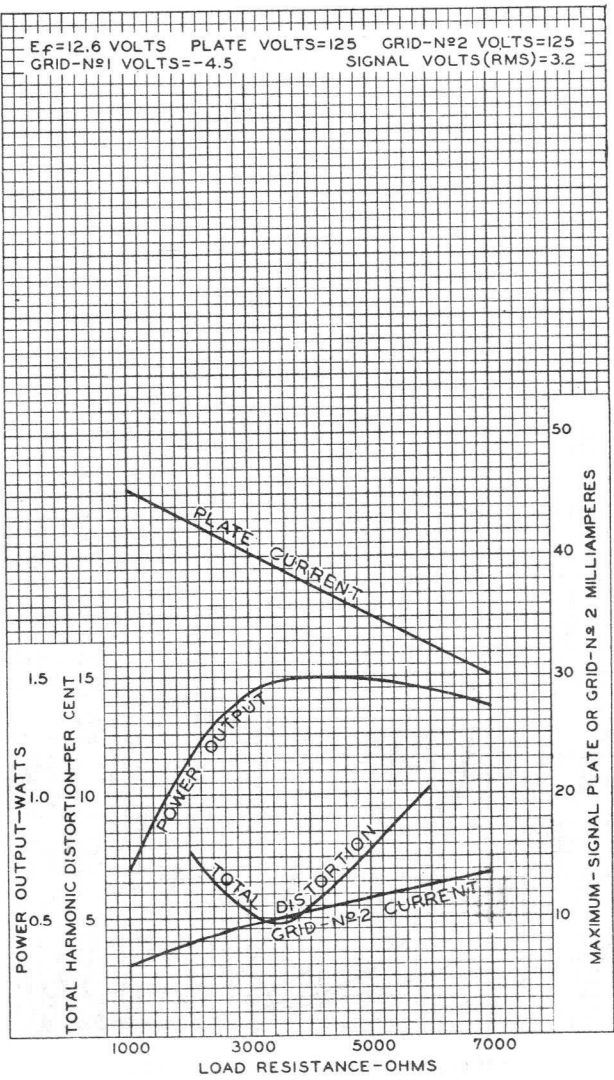

JAN. 20, 1955

TUBE DIVISION
RADIO CORPORATION OF AMERICA, HARRISON, NEW JERSEY

92CM-8506R1

12CK3

Half-Wave Vacuum Rectifier

NOVAR TYPE

For Black-and White TV Damper Service

The 12CK3 is the same as the 6CK3 except for the following items:

Heater Characteristics and Ratings

Current.	0.600 ± 0.040	A
Voltage.	12.6	V
Warm-up time (Average)	11	s

12CL3

Half-Wave Vacuum Rectifier

NOVAR TYPE

For Color TV Damper Service

The 12CL3 is the same as the 6CL3 except for the following items:

Heater Characteristics and Ratings

Current.	0.600 ± 0.040	A
Voltage.	12.6	V
Warm-up time (Average)	11	s







12CR6

12CR6

DIODE-REMOTE-CUTOFF PENTODE

7-PIN MINIATURE TYPE

GENERAL DATA

Electrical:

Heater, for Unipotential Cathode:

Voltage.	12.6	ac or dc volts
Current.	0.15	amp

Mechanical:

Mounting Position.	Any
Maximum Overall Length	2-1/8"
Maximum Seated Length.	1-7/8"
Length, Base Seat to Bulb Top (Excluding tip).	1-1/2" ± 3/32"
Maximum Diameter	3/4"
Dimensional Outline.	See General Section
Bulb	T-5-1/2
Base	Small-Button Miniature 7-Pin (JETEC No. E7-1)
Basing Designation for BOTTOM VIEW	7EA

- Pin 1 - Cathode, Pentode Grid No. 3
- Pin 2 - Diode Plate
- Pin 3 - Heater
- Pin 4 - Heater

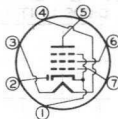

- Pin 5 - Pentode Plate
- Pin 6 - Pentode Grid No. 2
- Pin 7 - Pentode Grid No. 1

PENTODE UNIT - Class A₁ Amplifier

Maximum Ratings, Design-Center Values:

PLATE VOLTAGE.	300 max.	volts
GRID-No. 2 (SCREEN-GRID) SUPPLY VOLTAGE.	300 max.	volts
GRID-No. 2 VOLTAGE.	See Grid-No. 2 Input Rating Chart at front of Receiving Tube Section	
GRID-No. 1 (CONTROL-GRID) VOLTAGE:		
Positive bias value.	0 max.	volts
PLATE DISSIPATION.	2.5 max.	watts
GRID-No. 2 INPUT:		
For grid-No. 2 voltages up to 150 volts.	0.3 max.	watt
For grid-No. 2 voltages between 150 and 300 volts.	See Grid-No. 2 Input Rating Chart at front of Receiving Tube Section	
PEAK HEATER-CATHODE VOLTAGE:		
Heater negative with respect to cathode.	100 max.	volts
Heater positive with respect to cathode.	100 max.	volts

Characteristics:

Plate Voltage.	250	volts
Grid-No. 2 Voltage.	100	volts
Grid-No. 1 Voltage.	-2	volts
Plate Resistance (Approx.)	0.8	megohm
Transconductance	2200	μmhos

12CR6



12CR6

DIODE-REMOTE-CUTOFF PENTODE

Plate Current.	9.6	ma
Grid-No.2 Current.	2.6	ma
Grid-No.1 Voltage (Approx.) for transconductance of 10 μ mhos	-32	volts

Maximum Circuit Values:

Grid-No.1-Circuit Resistance:		
For cathode-bias operation	1.0 max.	megohm
For fixed-bias operation	0.25 max.	megohm

DIODE UNIT

Maximum Ratings, Design-Center Values:

PLATE CURRENT.	1.0 max.	ma
------------------------	----------	----

AVERAGE PLATE CHARACTERISTIC
DIODE UNIT

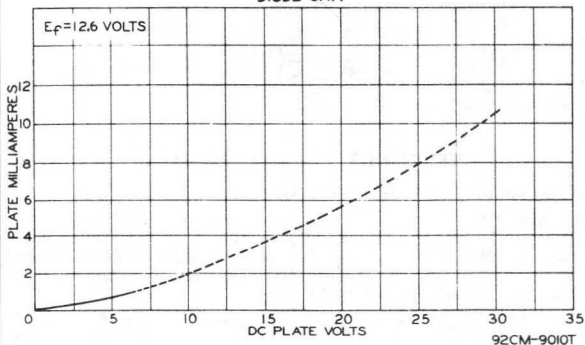



12CR6

12CR6

AVERAGE PLATE CHARACTERISTICS PENTODE UNIT

$E_p = 12.6$ VOLTS
GRID-№2 VOLTS = 100

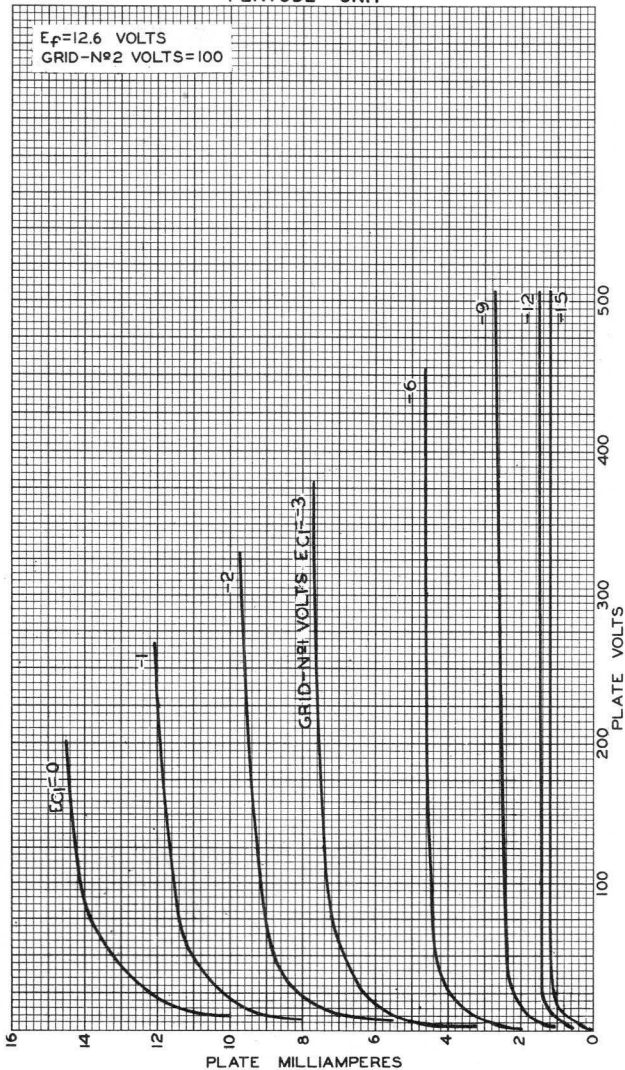

12CR6



12CR6

AVERAGE CHARACTERISTICS
PENTODE UNIT

$E_f = 12.6$ VOLTS
PLATE VOLTS = 250
GRID-N^o2 VOLTS = 100

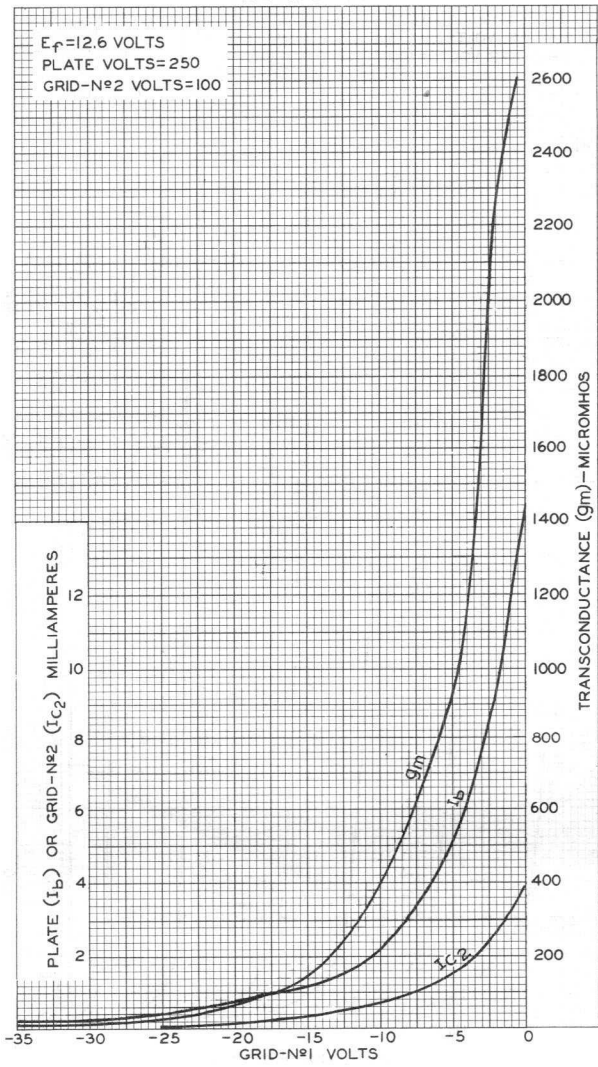

TUBE DIVISION

RADIO CORPORATION OF AMERICA, HARRISON, NEW JERSEY

92CM-9004

12CT3

Half-Wave Vacuum Rectifier

9-Pin Miniature Type

The 12CT3 is the same as the 6CT3 except for:

Heater Characteristics and Ratings

Current	0.600 ± 0.040 A
Voltage (ac or dc) at 0.600 A	12.6 V
Warm-up time (Average)	11 s

12CU5/12C5

Beam Power Tube

7-Pin Miniature Type

The 12CU5/12C5 is the same as the 6CU5 except for:

Heater Characteristics and Ratings

Current	0.600 ± 0.040 A
Voltage (ac or dc) at 0.600 A	12.6 V
Warm-up time (Average)	11 s





12D4

12D4

HALF-WAVE VACUUM RECTIFIER

Intended for TV damper service in equipment having series heater-string arrangement

GENERAL DATA

Electrical:

Heater, for Unipotential Cathode:

Voltage.	12.6 ac or dc volts
Current.	0.6 amp
Warm-up time (Average).	11 sec

For definition of heater warm-up time and method of determining it, see sheet HEATER WARM-UP TIME MEASUREMENT at front of this Section.

Direct Interelectrode Capacitances (Approx.):^o

Plate to cathode and heater.	6	$\mu\mu\text{f}$
Cathode to plate and heater.	8	$\mu\mu\text{f}$
Heater to cathode.	3	$\mu\mu\text{f}$

Mechanical:

Operating Position	Any
Maximum Overall Length	3-5/16"
Maximum Seated Length.	2-3/4"
Maximum Diameter	1-9/32"
Dimensional Outline.See General Section
Bulb	T9
Base	Intermediate-Shell Octal 5-Pin, Arrangement 2 (JEDEC Group 1, No.B5-82), Intermediate-Shell Octal 6-Pin, Arrangement 1 (JEDEC Group 1, No.B6-8), Short Intermediate-Shell Octal 5-Pin with External Barriers, Arrangement 2 (JEDEC Group 1, No.B5-85), or Short Intermediate-Shell Octal 6-Pin with External Barriers, Arrangement 1 (JEDEC Group 1, No.B6-60)
Basing Designation for BOTTOM VIEW4CG

Pin 1 \blacklozenge - Same as Pin 2
 Pin 2 - Internal Connection - Do Not Use \bullet

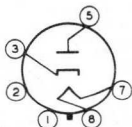

Pin 3 - Cathode
 Pin 5 - Plate
 Pin 7 - Heater
 Pin 8 - Heater

DAMPER SERVICE

Maximum Ratings, Design-Maximum Values:

For operation in a 525-line, 30-frame system[□]

PEAK INVERSE PLATE VOLTAGE*	4400	max.	volts
PEAK PLATE CURRENT.	900	max.	ma
DC PLATE CURRENT.	155	max.	ma

^o, \blacklozenge , \bullet , \square , * : See next page.

12D4



12D4

HALF-WAVE VACUUM RECTIFIER

PLATE DISSIPATION. 5.5 max. watts

PEAK HEATER-CATHODE VOLTAGE:

Heater negative with respect to cathode. 4400[▲] max. volts

Heater positive with respect to cathode. 300[#] max. volts

○ Without external shield.

◆ On the 5-pin bases, pin 1 as well as pins 4 and 6 is omitted.

● Socket terminals 1,2,4 and 6 should not be used as tie points.

□ As described in "Standards of Good Engineering Practice Concerning Television Broadcast Stations," Federal Communications Commission.

* This rating is applicable when the duty cycle of the voltage pulse does not exceed 15 per cent of one horizontal scanning cycle. In a 525-line, 30-frame system, 15 per cent of one horizontal scanning cycle is 10 microseconds.

▲ The dc component must not exceed 900 volts.

The dc component must not exceed 100 volts.

4-59

TENTATIVE DATA

AVERAGE PLATE CHARACTERISTIC

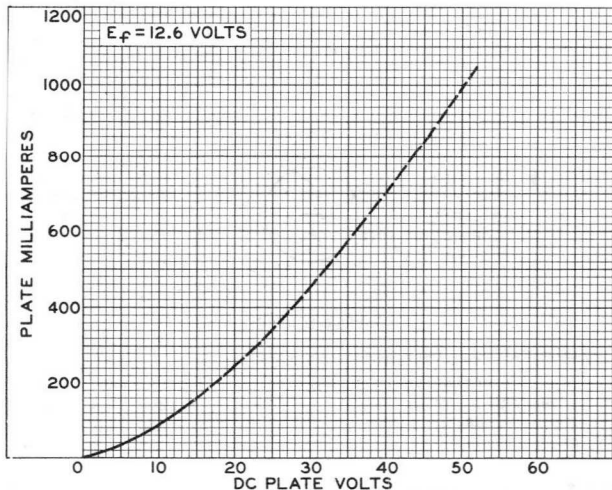

ELECTRON TUBE DIVISION

92CS-9757

RADIO CORPORATION OF AMERICA, HARRISON, NEW JERSEY

Beam Power Tube

9-PIN MINIATURE TYPE

With Heater Having Controlled Warm-Up Time

The 12DB5 is the same as the 6DB5 except for the following items:

Heater, for Unipotential Cathode:

Voltage (AC or DC)	12.6	volts
Current	0.6 ± 6%	amp
Warm-up time (Average)	11	sec



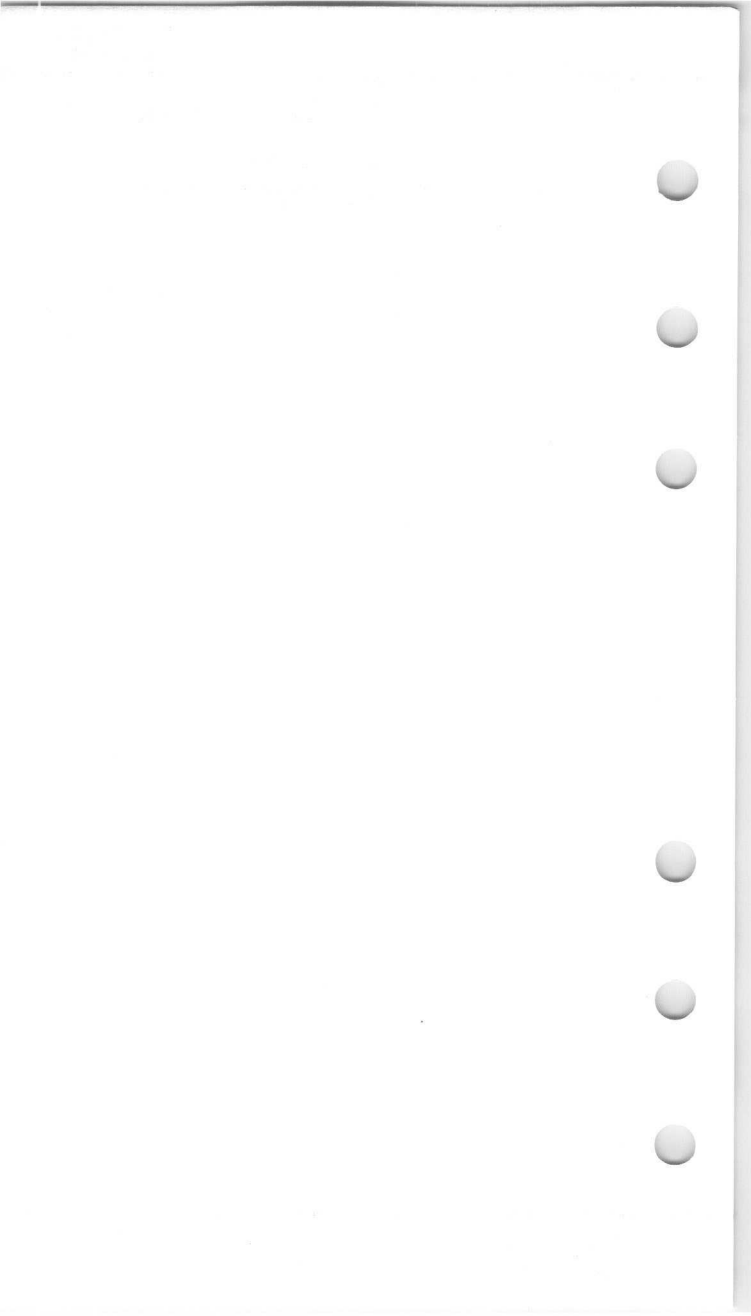

12DM4

Half-Wave Vacuum Rectifier

For Damper Service in TV Equipment
Having Series Heater-String Arrangement

The 12DM4 is the same as the 6DM4 except for the following items:

Heater, for Unipotential Cathode:		
Voltage (AC or DC)	12.6	volts
Current	0.6 ± 6%	amp
Warm-up time (Average).	11	sec

12DQ6A

Beam Power Tube

For Equipment Having Series Heater-String Arrangement

The 12DQ6A is the same as the 6DQ6A except for the following items:

Heater, for Unipotential Cathode:		
Voltage (AC or DC)	12.6	volts
Current	0.6 ± 6%	amp
Warm-up time (Average).	11	sec

12DQ6B

Beam Power Tube

For Equipment Having Series Heater-String Arrangement

The 12DQ6B is the same as the 6DQ6B except for the following items:

Heater, for Unipotential Cathode:		
Voltage (AC or DC)	12.6	volts
Current	0.6 ± 6%	amp
Warm-up time (Average).	11	sec



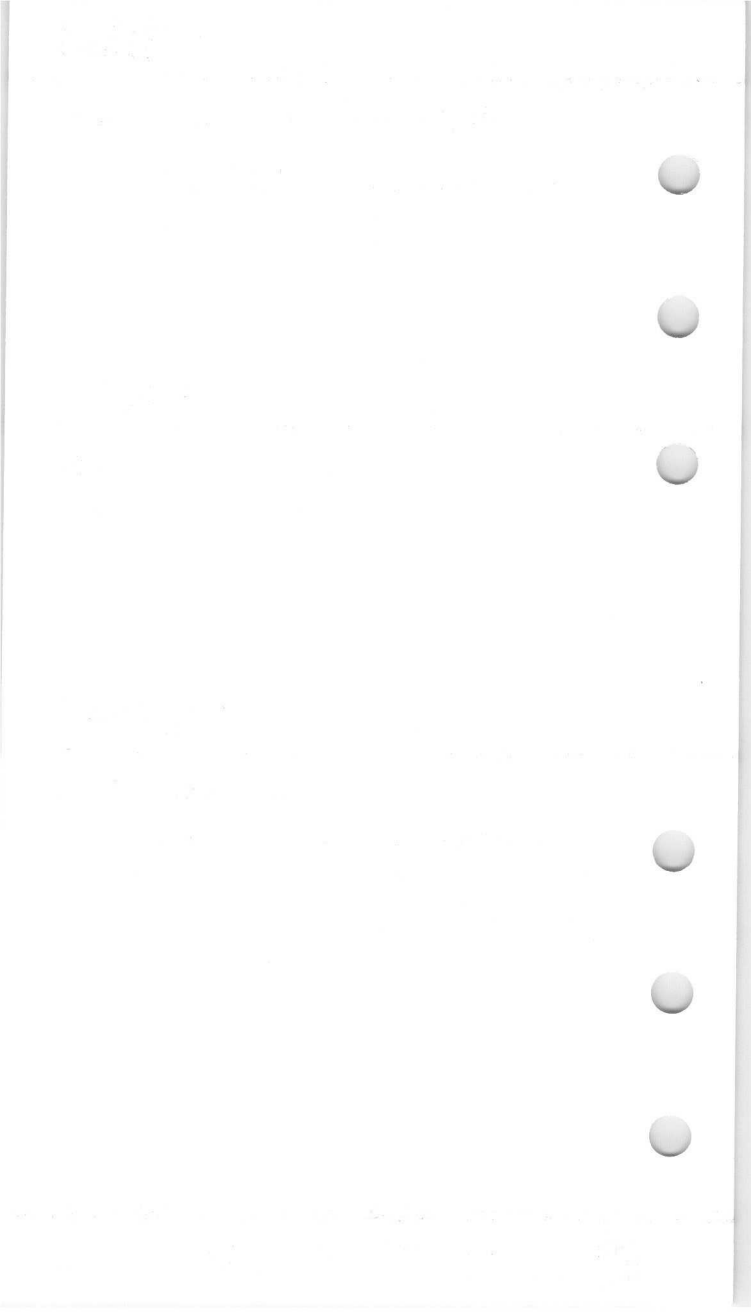

12DQ6-A

Beam Power Tube

For Equipment Having Series Heater-String Arrangement

The 12DQ6-A is the same as the 6DQ6-A except for the following items:

Heater, for Unipotential Cathode:

Voltage (AC or DC)	12.6	volts
Current	0.6 ± 6%	amp
Warm-up time (Average)	11	sec

12DQ6-B

Beam Power Tube

For Equipment Having Series Heater-String Arrangement

The 12DQ6-B is the same as the 6DQ6-B except for the following items:

Heater, for Unipotential Cathode:

Voltage (AC or DC)	12.6	volts
Current	0.6 ± 6%	amp
Warm-up time (Average)	11	sec



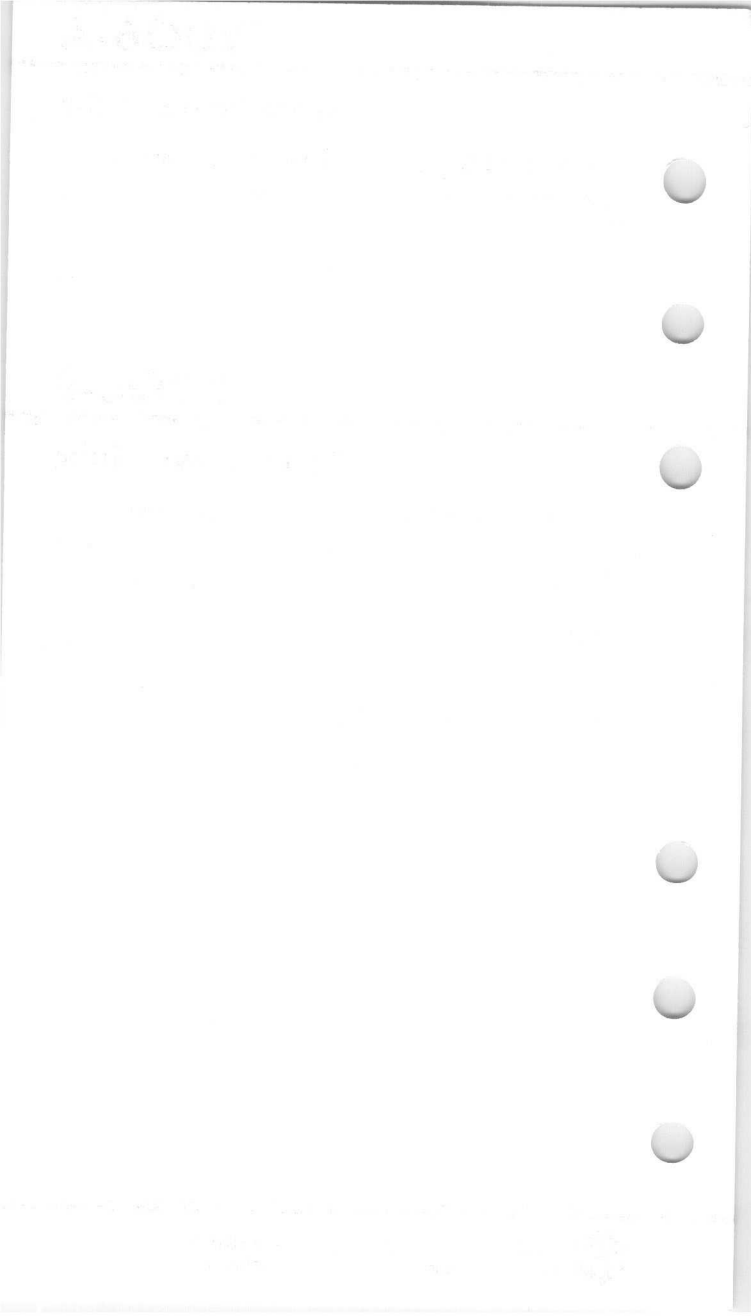



12DT5
12DT8

12DT5

BEAM POWER TUBE

9-PIN MINIATURE TYPE

Intended for use in equipment having series heater-string arrangement

The 12DT5 is the same as the 6DT5 except for the following items:

Heater, for Unipotential Cathode:

Voltage (AC or DC)	12.6	volts
Current	0.6 ± 6%	amp
Warm-up time (Average)	11	sec

12DT8

HIGH-MU TWIN TRIODE

9-PIN MINIATURE TYPE

The 12DT8 is the same as the 5DT8 except for the following items:

Heater, for Unipotential Cathodes:

Voltage (AC or DC)	12.6	volts
Current	0.15	amp

10-38

BEAM TUBE TUBE

Indicated for use in electronic tubes

Part No.	10-38
Quantity	100
Weight	0.15
Volume	0.05
Material	Aluminum
Finish	Anodized
Notes	See drawing for details

HIGH-MOD TUBE TUBE

Part No.	10-38
Quantity	100
Weight	0.15
Volume	0.05
Material	Aluminum
Finish	Anodized
Notes	See drawing for details



12DZ6

12DZ6

REMOTE-CUTOFF PENTODE

7-PIN MINIATURE TYPE

For use in automobile radio receivers operating directly from 6-cell storage-battery systems

GENERAL DATA

Electrical:

Heater, for Unipotential Cathode:
Voltage range (DC) 10 to 15.9 volts

For longest life, it is recommended that the heater be operated within the voltage range of 11 to 14 volts.

Current (Approx.) at 12.6 volts 0.19 amp

Direct Interelectrode Capacitances:^o

Grid No.1 to plate 0.05 max. μf

Grid No.1 to cathode, grid No.3 & internal shield, grid No.2, and heater. 9.5 μf

Plate to cathode, grid No.3 & internal shield, grid No.2, and heater 4 μf

Characteristics, Class A₁ Amplifier:

Heater Voltage 12.6 volts

Plate Voltage 12.6 volts

Grid No.3 and Internal Shield. *Connected to cathode at socket*

Grid-No.2 Voltage 12.6 volts

Grid-No.1 Supply Voltage 0 volts

Grid-No.1 Resistor (Bypassed) 10 megohms

Grid-No.3 Resistor (Bypassed) 10 megohms

Plate Resistance (Approx.) 25000 ohms

Transconductance 3800 μmhos

Plate Current 4.5 ma

Grid-No.2 Current 2.2 ma

Grids No.1 and No.3 Supply Voltage (Approx.) for transconductance, grid No.1 to plate (μmhos) = 10. -10 volts

Mechanical:

Operating Position Any

Maximum Overall Length 2-1/8"

Maximum Seated Length 1-7/8"

Length, Base Seat to Bulb Top (Excluding tip) 1-1/2" \pm 3/32"

Diameter 0.650" to 0.750"

Dimensional Outline See General Section

Bulb T5-1/2

Base Small-Button Miniature 7-Pin (JEDEC No.E7-1)

Basing Designation for BOTTOM VIEW 7BK

Pin 1-Grid No.1

Pin 2-Grid No.3,
Internal
Shield

Pin 3-Heater

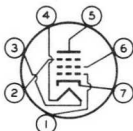

Pin 4-Heater

Pin 5-Plate

Pin 6-Grid No.2

Pin 7-Cathode

^o Without external shield.

12DZ6



12DZ6

REMOTE-CUTOFF PENTODE

AMPLIFIER — Class A₁

Maximum Ratings, Design-Maximum Values:

PLATE VOLTAGE.	16 max.	volts
GRID No.3 (SUPPRESSOR GRID).	<i>Connect to cathode at socket</i>	
GRID-No.2 (SCREEN-GRID) VOLTAGE.	16 max.	volts
GRID-No.1 (CONTROL-GRID) VOLTAGE:		
Positive-bias value.	0 max.	volts
PEAK HEATER-CATHODE VOLTAGE:		
Heater negative with respect to cathode.	16 max.	volts
Heater positive with respect to cathode.	16 max.	volts

Maximum Circuit Values:

Grid-No.1-Circuit Resistance	10 max.	megohms
Grid-No.3-Circuit Resistance	10 max.	megohms



12DZ6

12DZ6

AVERAGE CHARACTERISTICS

$E_f = 12.6$ VOLTS

GRID N^o3 AND INTERNAL SHIELD
CONNECTED TO CATHODE AT SOCKET.
GRID-N^o2 VOLTS = 12.6

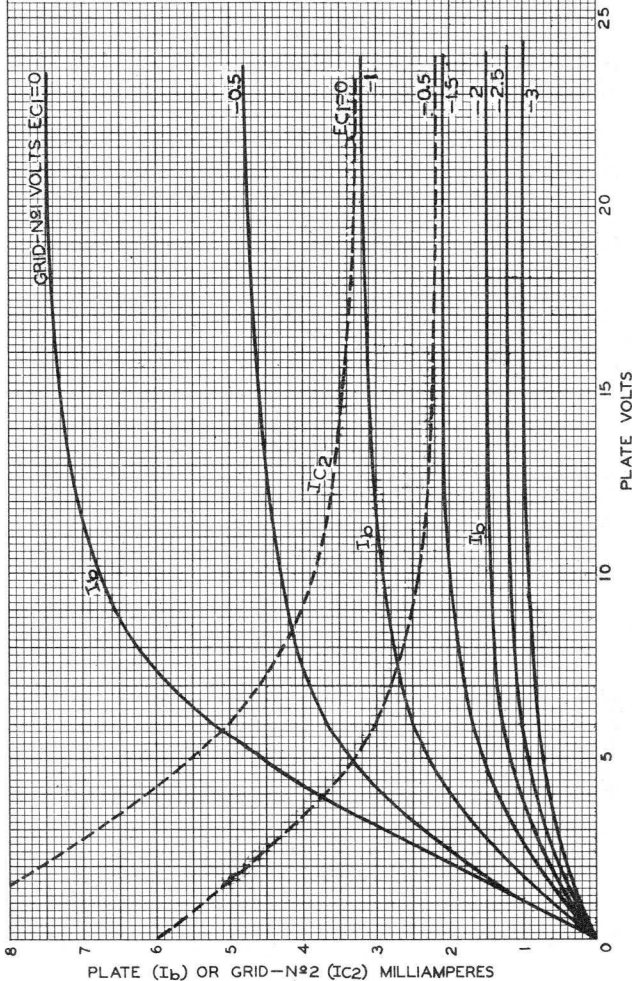

PLATE (I_b) OR GRID-N^o2 (I_{c2}) MILLIAMPERES

ELECTRON TUBE DIVISION

92CM-10399

RADIO CORPORATION OF AMERICA, HARRISON, NEW JERSEY

12DZ6



12DZ6

AVERAGE CHARACTERISTICS

$E_f = 12.6$ VOLTS
PLATE VOLTS = 12.6
GRID N^o3 AND INTERNAL SHIELD
CONNECTED TO CATHODE AT
SOCKET.
GRID-N^o2 VOLTS = 12.6

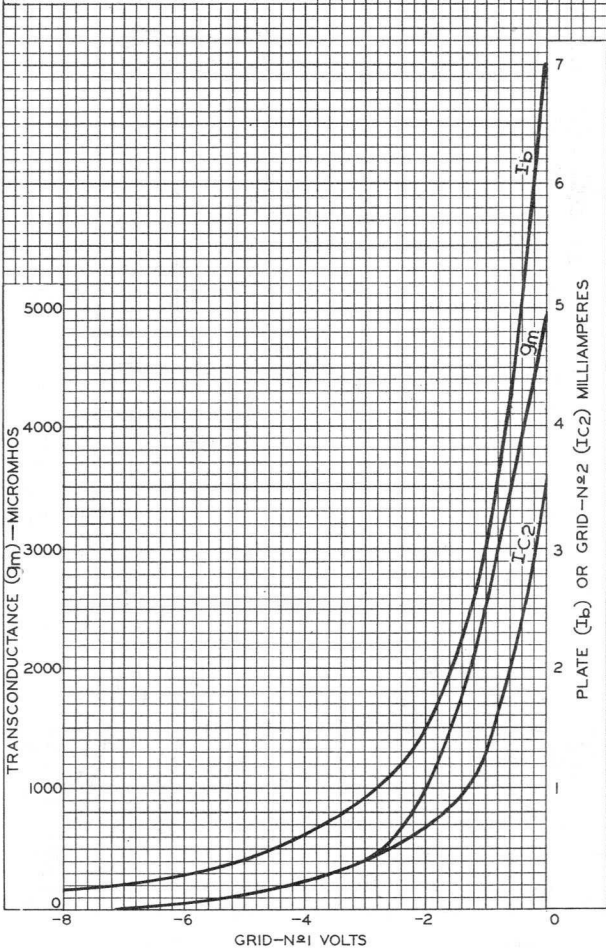

ELECTRON TUBE DIVISION

RADIO CORPORATION OF AMERICA, HARRISON, NEW JERSEY

92CM-10404

Medium-Mu Twin Triode

9-Pin Miniature Type

Controlled Heater Warm-up Time

The 12FQ7 is the same as the 6FQ7 except for:

Heater Characteristics and Ratings

Current 0.300 + 0.020 A

Voltage (ac or dc) at 0.300 A 12.6 V

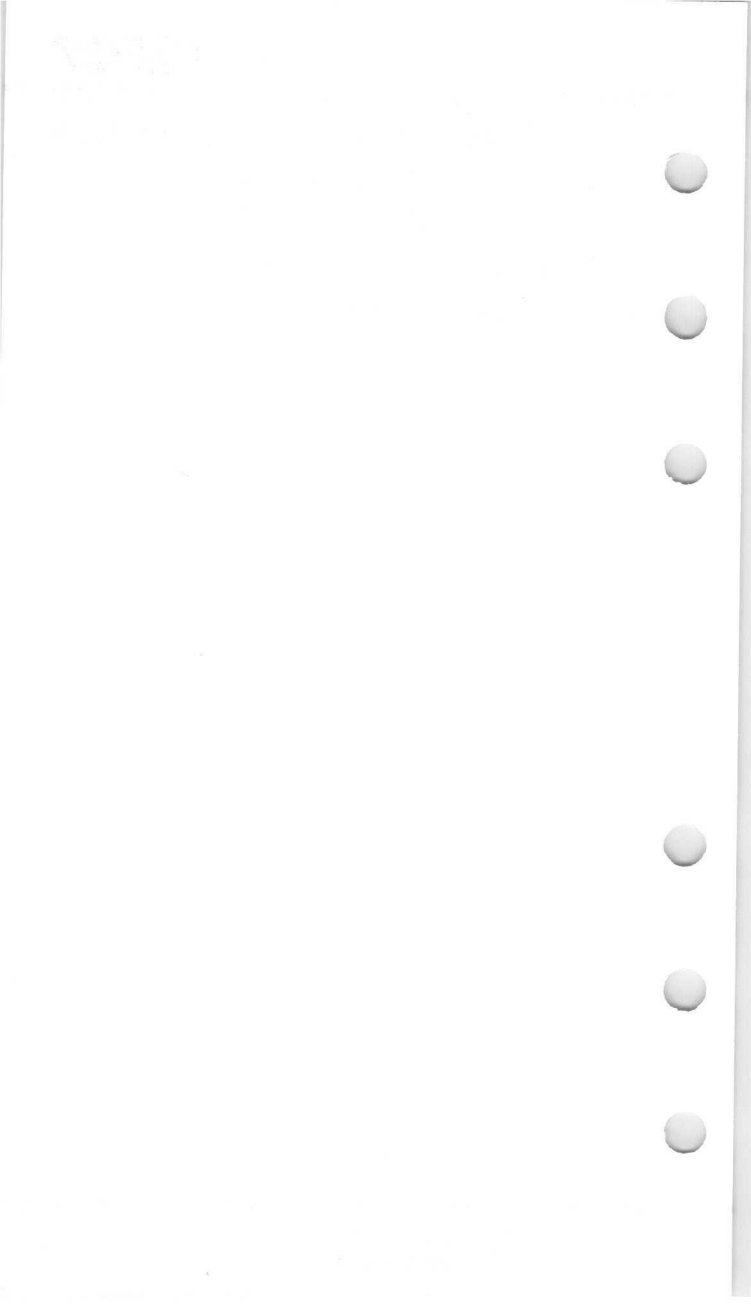

High-Mu Twin Double-Plate Triode

9-PIN MINIATURE TYPE

For Frequency-Divider and Complex-Wave-Generator
Circuits of Electronic Musical Instruments

GENERAL DATA

Electrical:

Heater, for Unipotential Cathode:

Voltage (AC or DC) 12.6 ± 10% volts
Current at 12.6 volts 0.15 amp

Direct Interelectrode Capacitances (Approx.):[▲]

Grid to either plate (Each unit) 0.9 μf
Grid to cathode and heater (Each Unit) 1.8 μf
Plate A of unit No.1 to cathode and heater 0.34 μf
Plate B of unit No.1 to cathode and heater 0.24 μf
Plate A of unit No.2 to cathode and heater 0.3 μf
Plate B of unit No.2 to cathode and heater 0.18 μf
Plate A to plate B (Each unit) 0.7 μf
Plate A of unit No.1 to plate A of
unit No.2 0.4 μf

Characteristics, Class A₁ Amplifier (Each Unit):

*Using either plate A or plate B, with
plate not in use connected to ground*

Plate Voltage 250 volts
Grid Voltage -1.5 volts
Amplification Factor 95
Plate Resistance (Approx.) 76000 ohms
Transconductance 1250 μmhos
Plate Current 1.5 ma

Mechanical:

Operating Position Any
Maximum Overall Length 2-3/16"
Maximum Seated Length 1-15/16"
Length, Base Seat to Bulb Top (Excluding tip) 1-9/16" ± 3/32"
Diameter 0.750" to 0.875"
Dimensional Outline See *General Section*
Bulb T6-1/2
Base Small-Button Noval 9-Pin (JEDEC No. E9-1)

Basing Designation for BOTTOM VIEW 9KT

Pin 1 - Plate B of
Unit No.2

Pin 2 - Grid of
Unit No.2

Pin 3 - Plate A of
Unit No.2

Pin 4 - Heater

Pin 5 - Heater

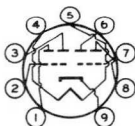

Pin 6 - Plate B of
Unit No.1

Pin 7 - Grid of
Unit No.1

Pin 8 - Plate A of
Unit No.1

Pin 9 - Cathode



12FQ8

FREQUENCY-DIVIDER & COMPLEX-WAVE-GENERATOR SERVICE

Values are for Each Unit

Maximum Ratings, Design-Maximum Values:

PLATE A VOLTAGE.	330	max.	volts
PLATE B VOLTAGE.	330	max.	volts
GRID VOLTAGE:			
Positive-bias value.	0	max.	volts
PLATE A DISSIPATION.	0.5	max.	watt
PLATE B DISSIPATION.	0.5	max.	watt
PEAK HEATER-CATHODE VOLTAGE:			
Heater negative with respect to cathode. . .	200	max.	volts
Heater positive with respect to cathode. . .	200 [•]	max.	volts

[▲] Without external shield.

[•] The dc component must not exceed 100 volts.



AVERAGE PLATE CHARACTERISTICS Each Unit

$E_f = 12.6$ VOLTS

USING EITHER PLATE A OR PLATE B, WITH
PLATE NOT IN USE CONNECTED TO GROUND.

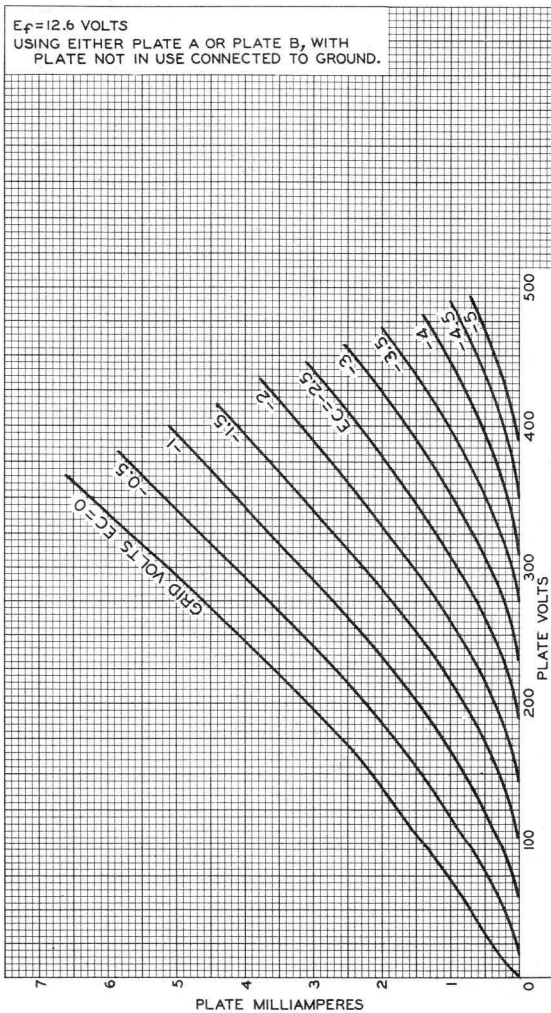

92CM-10755RI



12FQ8

AVERAGE CHARACTERISTICS Each Unit

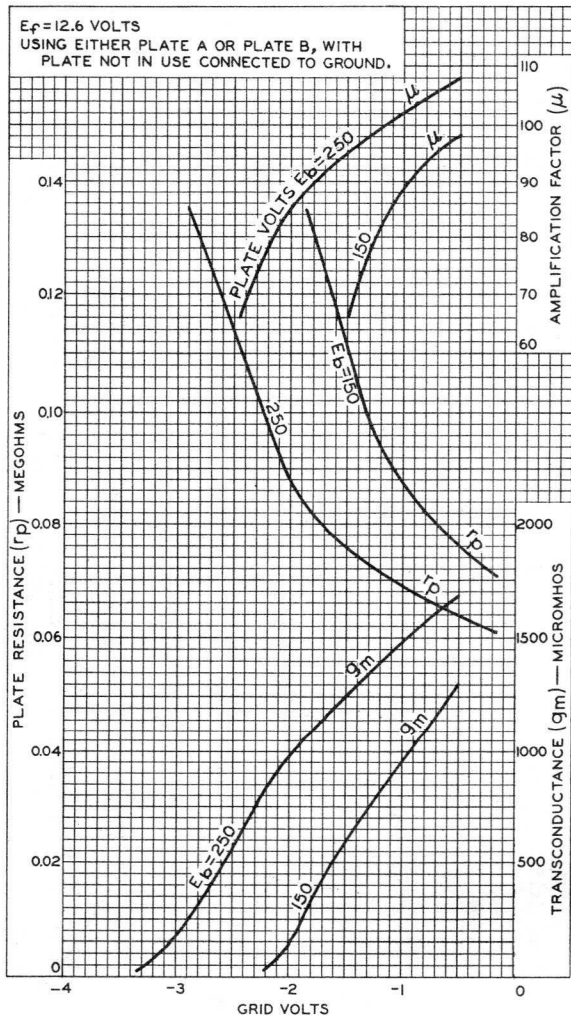

92CM-10754RI



Power Pentode

7-PIN MINIATURE TYPE

The 12FX5 is the same as the 60FX5 except for the following items:

Heater Characteristics and

Ratings:

Voltage (AC or DC)	12.6 ^a	12.6 ± 1.3	volts
Current	0.450 ± 0.030	0.450 ^b	amp
Warm-up time (Average)	11	-	sec

^a At heater amperes = 0.450.

^b At heater volts = 12.6.



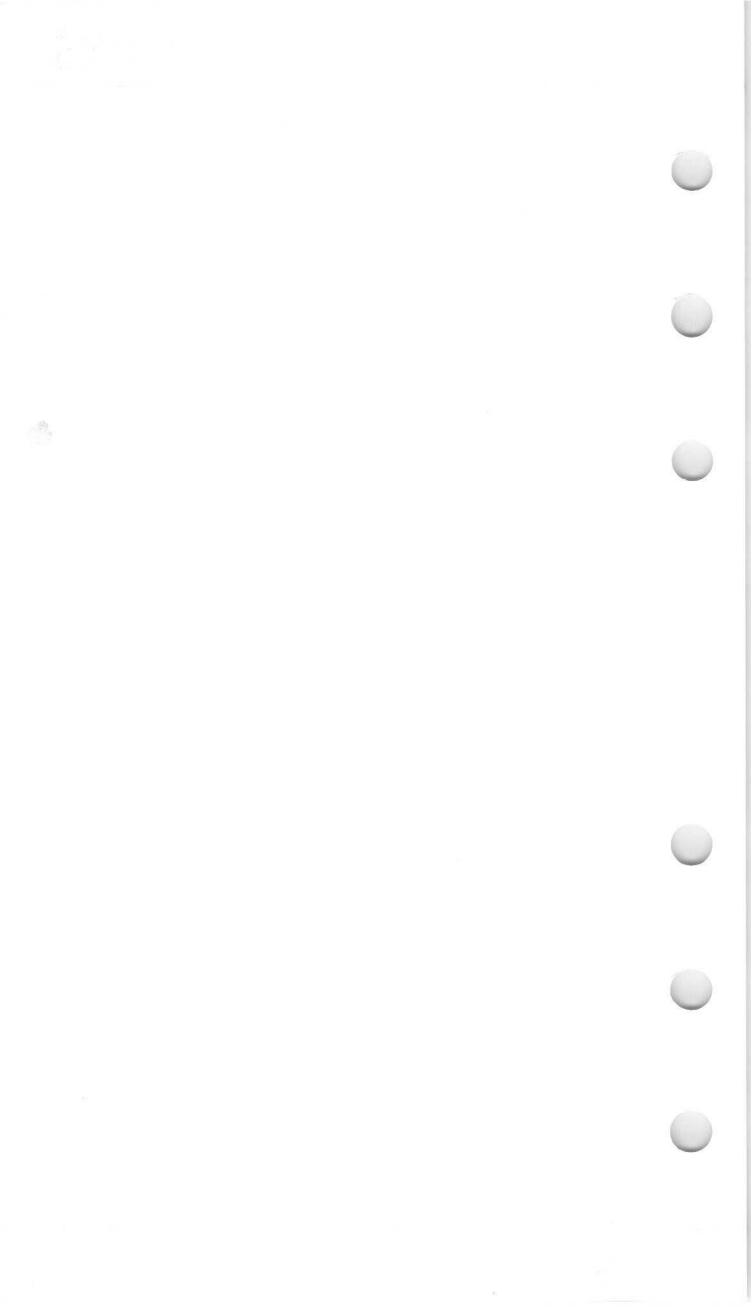

Beam Power Tube

With Heater Having Controlled Warm-Up Time

GENERAL DATA

Electrical:

Heater, for Unipotential Cathode:

Voltage (AC or DC)	12.6	volts
Current	0.6 ± 6%	amp
Warm-up time (Average)	11	sec

Direct Interelectrode Capacitances:^a

Grid No.1 to plate	0.55	μf
Grid No.1 to cathode, grid No.3, grid No.2, and heater	15	μf
Plate to cathode, grid No.3, grid No.2, and heater	7	μf

Characteristics, Class A₁ Amplifier:

Plate Voltage	60	250	volts
Grid-No.2 Voltage	150	150	volts
Grid-No.1 Voltage	0	-22.5	volts
Triode Amplification Factor for plate volts = grid-No.2 volts = 150	-	4.1	
Plate Resistance (Approx.)	-	20000	ohms
Transconductance	-	6600	μhos
Plate Current	345 ^b	75	ma
Grid-No.2 Current	30 ^b	2.4	ma
Grid-No.1 Voltage (Approx.) for plate ma. = 1	-	-46	volts
Grid-No.1 Voltage (Approx.) for peak positive-pulse plate volts = 5000, grid- No.2 volts = 150, and plate ma. = 1	-	-100	volts

Mechanical:

Operating Position	Any
Maximum Overall Length	4-1/4"
Seated Length	3-1/2" ± 3/16"
Maximum Diameter	1-9/16"
Bulb	T12
Cap	Skirted Miniature (JEDEC No.C1-3)
Base	Short Medium-Shell Octal 6-Pin with External Barriers, Arrangement 2, Style B, (JEDEC Group 1, No.B6-122)

Basing Designation for BOTTOM VIEW. 8JX

- Pin 2 - Heater
- Pin 3 - Cathode,
Grid No.3
- Pin 4 - Grid No.2

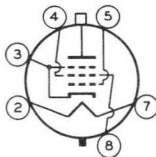

- Pin 5 - Grid No.1
- Pin 7 - Heater
- Pin 8 - Grid No.2
- Cap - Plate



12GC6

HORIZONTAL-DEFLECTION AMPLIFIER

Maximum Ratings, Design-Maximum Values:

For operation in a 525-line, 30-frame system^c

DC PLATE VOLTAGE.	770	max.	volts
PEAK POSITIVE-PULSE PLATE VOLTAGE ^d	6500	max.	volts
PEAK NEGATIVE-PULSE PLATE VOLTAGE	1500	max.	volts
DC GRID-No.2 (SCREEN-GRID) VOLTAGE.	220	max.	volts
PEAK NEGATIVE-PULSE GRID-No.1 VOLTAGE	330	max.	volts
CATHODE CURRENT:			
Peak.	550	max.	ma
Average	175	max.	ma
GRID-No.2 INPUT	4.5	max.	watts
PLATE DISSIPATION ^e	17.5	max.	watts
PEAK HEATER-CATHODE VOLTAGE:			
Heater negative with respect to cathode.	200	max.	volts
Heater positive with respect to cathode.	200 ^f	max.	volts
BULB TEMPERATURE (At hottest point on bulb surface).	220	max.	°C

Maximum Circuit Values:

Grid-No.1-Circuit Resistance.	1	max.	megohm
---------------------------------------	---	------	--------

^a Without external shield.

^b This value can be measured by a method involving a recurrent wave form such that the maximum ratings of the tube will not be exceeded.

^c As described in "Standards of Good Engineering Practice Concerning Television Broadcast Stations," Federal Communications Commission.

^d This rating is applicable where the duration of the voltage pulse does not exceed 15 per cent of one horizontal scanning cycle. In a 525-line, 30-frame system, 15 per cent of one horizontal scanning cycle is 10 microseconds.

^e An adequate bias resistor or other means is required to protect the tube in the absence of excitation.

^f The dc component must not exceed 100 volts.



12GE5

Beam Power Tube

DUODECAR TYPE

The 12GE5 is the same as the 6GE5 except for the following items:

Heater Characteristics and Ratings:

Current	0.600 ± 0.040	amp
Voltage (AC or DC) at heater amperes = 0.600	12.6	volts
Warm-up time (Average)	11	sec

12GJ5

Beam Power Tube

NOVAR TYPE

The 12GJ5 is the same as the 6GJ5 except for the following items:

Heater Characteristics and Ratings:

Current	0.600 ± 0.040	amp
Voltage (AC or DC) at heater amperes = 0.600	12.6	volts
Warm-up time (Average)	11	sec





12GT5

Beam Power Tube

NOVAR TYPE

The 12GT5 is the same as the 6GT5 except for the following items:

Heater Characteristics and Ratings:

Current.	0.600 ± 0.040	amp
Voltage (AC or DC) at heater amperes = 0.600	12.6	volts
Warm-up time (Average)	11	sec

12GT5A

Beam Power Tube

NOVAR TYPE

The 12GT5A is the same as the 6GT5A except for the following items:

Heater Characteristics and Ratings:

Current.	0.600 ± 0.040	amp
Voltage (AC or DC) at heater amperes = 0.600	12.6	volts
Warm-up time (Average)	11	sec

12GW6

Beam Power Tube

The 12GW6 is the same as the 6GW6 except for the following items:

Heater Characteristics and Ratings:

Current.	0.600 ± 0.040	amp
Voltage (AC or DC) at heater amperes = 0.600	12.6	volts
Warm-up time (Average)	11	sec



12H6

Twin Diode

The 12H6 is the same as the 6H6 except for the following items:

Heater Characteristics and Ratings:

Voltage (AC or DC)	12.6	volts
Current	0.150	amp



Sharp-Cutoff Pentode

FRAME-GRID CONSTRUCTION

T9 ENVELOPE

9-PIN LARGE-BUTTON NEOVAL BASE

For Video Output Amplifier Service
in Color TV Receivers

Electrical:

Heater Characteristics and Ratings:

	Series	Parallel	
Heater-section arrangement			
Voltage (AC or DC)	12.6 ± 1.3 ^a	6.3 ± 0.6	volts
Current	0.260	0.520 ^b	amp
Maximum heater-cathode voltage:			
Heater negative with respect to cathode		200	volts
Heater positive with respect to cathode:			
Peak		200	volts
DC component		100	volts

Direct Interelectrode Capacitances:^c

Grid No.1 to plate	0.15 max.	pf
Input: G1 to (K, G3 + IS, G2, H)	14.0	pf
Output: P to (K, G3 + IS, G2, H)	4.4	pf

Mechanical:

Operating Position	Any
Type of Cathode	Coated Unipotential
Maximum Overall Length	2.930"
Maximum Seated Length	2.620"
Length, Base Seat to Bulb Top (Excluding tip)	2.070" to 2.310"
Diameter	1.062" to 1.188"
Dimensional Outline	(JEDEC No.9-70)
Bulb	T9
Base	Large-Button Neonoval 9-Pin (JEDEC No.E9-68)
Basing Designation for BOTTOM VIEW	9BF

- Pin 1 - Cathode
- Pin 2 - Grid No.1
- Pin 3 - Grid No.3,
 Internal Shield
- Pin 4 - Heater
- Pin 5 - Heater
- Pin 6 - Heater Tap
- Pin 7 - Plate
- Pin 8 - Grid No.2
- Pin 9 - Grid No.3,
 Internal Shield

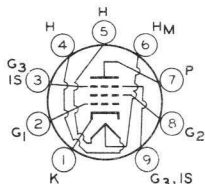

Characteristics, Class A₁ Amplifier:

Plate Supply Voltage	300	volts
Grid No.3	Connected to cathode at socket	
Grid-No.2 Supply Voltage	135	volts
Grid No.1	Connected to negative end of cathode resistor	
Cathode Resistor	47	ohms
Plate Resistance (Approx.)	60000	ohms
Transconductance	32000	μmhos
Plate Current	31	ma



12HG7

Grid-No.2 Current	4.8	ma
Grid-No.1 Voltage (Approx.) for plate $\mu a = 100$	-4.5	volts

CLASS A₁ AMPLIFIER

Maximum Ratings, Design-Maximum Values:

Plate Voltage	400	volts
Grid-No.2 (Screen-Grid) Supply Voltage.	330	volts
Grid-No.2 VoltageSee <i>Grid-No.2 Input Rating Chart</i> at front of Receiving Tube Section	
Grid-No.1 (Control-Grid) Voltage:		
Positive-bias value	0	volts
Grid-No.2 Input:		
For grid-No.2 voltages up to 165 volts.	1	watt
For grid-No.2 voltages between 165 and 330 voltsSee <i>Grid-No.2 Input Rating Chart</i> at front of Receiving Tube Section	
Plate Dissipation	10	watts

Maximum Circuit Values:

Grid-No.1-Circuit Resistance:		
For fixed-bias operation.	0.1	megohm
For cathode-bias operation.	0.25	megohm

- ^a At heater amperes = 0.260.
- ^b At heater volts = 6.3.
- ^c without external shield.



DIMENSIONAL OUTLINE

JEDEC No. 9-70

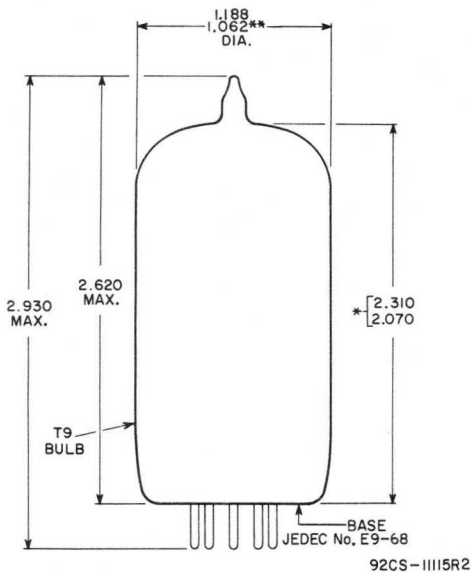

DIMENSIONS IN INCHES

** Applies in zone starting 0.375" from base seat.

* Measured from base seat to bulb-top line as determined by a ring gauge of 0.600" inside diameter.



AVERAGE CHARACTERISTICS

$E_f = 6.3$ VOLTS
 GRID No.3 CONNECTED TO CATHODE AT SOCKET.
 GRID - No.2 VOLTS = 135

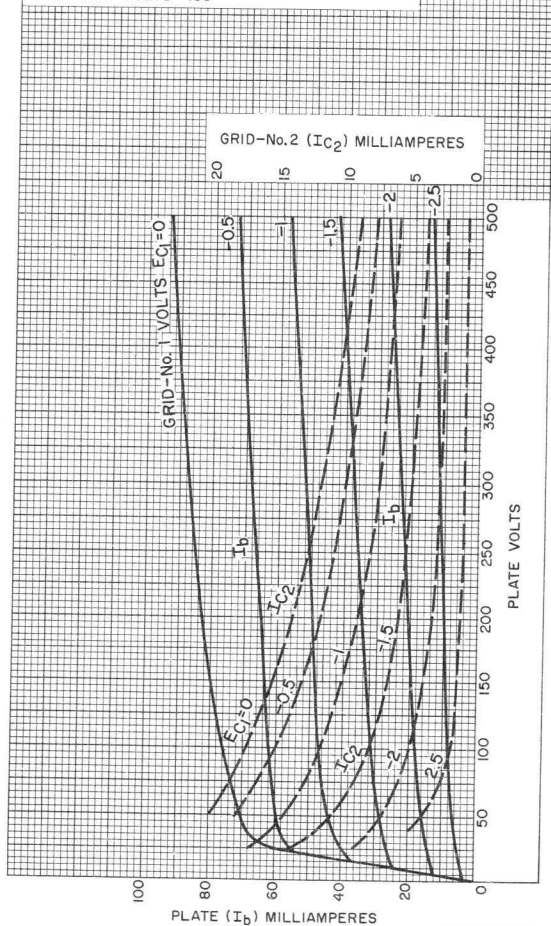

92CM-12746RI



AVERAGE CHARACTERISTICS

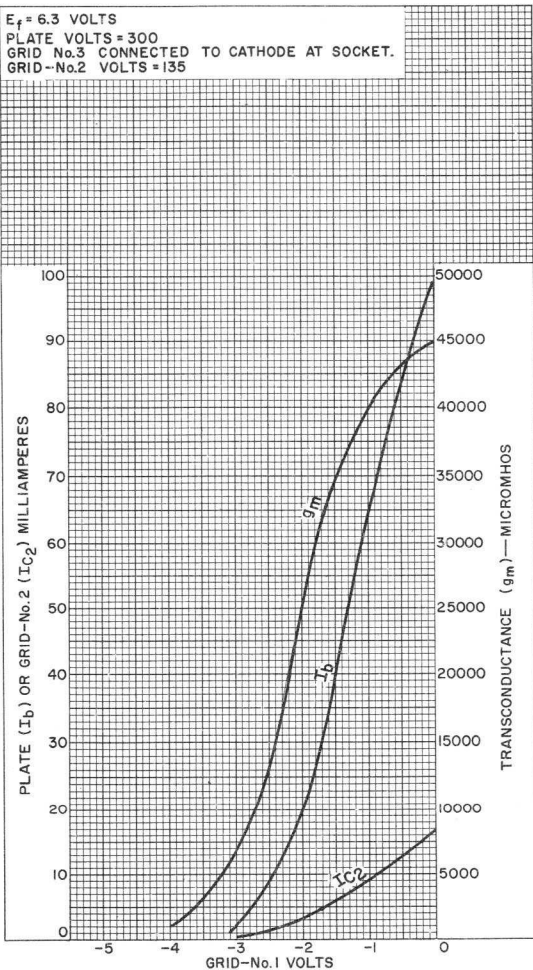

92CM-12747RI





12JB6A

Beam Power Tube

NOVAR TYPE

The 12JB6A is the same as the 6JB6A except for:

Heater Characteristics and Ratings

Current.	0.600 ± 0.040	A
Voltage (AC or DC) at 0.600 A . .	12.6	V
Warm-up time (Average).	11	s

12JQ6

Beam Power Tube with an Integral Diode

The 12JQ6 is the same as the 6JQ6 except for:

Heater Characteristics and Ratings

Current.	0.600 ± 0.040	A
Voltage (AC or DC) at 0.600 A . .	12.6	V
Warm-up time (Average).	11	s

12JT6A

Beam Power Tube

NOVAR TYPE

The 12JT6A is the same as the 6JT6A except for:

Heater Characteristics and Ratings

Current.	0.600 ± 0.040	A
Voltage (AC or DC) at 0.600 A . .	12.6	V
Warm-up time (Average).	11	s

12MN8

High-Mu Triple Triode

DUODECAR TYPE

The 12MN8 is the same as the 6MN8 except for:

Heater Characteristics and Ratings

Current.	0.450 ± 0.030	A
Voltage (AC or DC) at 0.450 A . .	12.6	V
Warm-up time (Average).	11	s

12SA7

Pentagrid Converter

The 12SA7 is the same as the 6SA7 except for the following items:

Heater Characteristics and Ratings:

Voltage (AC or DC)	12.6	volts
Current	0.150	amp

12SJ7

Sharp-Cutoff Pentode

The 12SJ7 is the same as the 6SJ7 except for the following items:

Heater Characteristics and Ratings:

Voltage (AC or DC)	12.6	volts
Current	0.150	amp

12SL7GT

High-Mu Twin Triode

The 12SL7GT is the same as the 6SL7GT except for the following items:

Heater Characteristics and Ratings:

Voltage (AC or DC)	12.6	volts
Current	0.150	amp

12SN7GTA

Medium-Mu Twin Triode

The 12SN7GTA is the same as the 6SN7GTA except for the following items:

Heater Characteristics and Ratings:

Voltage (AC or DC)	12.6	volts
Current	0.300	amp



12SQ7

Twin Diode-Medium-Mu Triode

The 12SQ7 is the same as the 6SQ7 except for the following items:

Heater Characteristics and Ratings:

Voltage (AC or DC)	12.6	volts
Current	0.150	amp

12V6GT

Beam Power Tube

The 12V6GT is the same as the 6V6GT except for the following items:

Heater Characteristics and Ratings:

Voltage (AC or DC)	12.6	volts
Current	0.225	amp

12W6GT

Beam Power Tube

The 12W6GT is the same as the 6W6GT except for the following items:

Heater Characteristics and Ratings:

Current	0.600	amp
Voltage (AC or DC)	12.6	volts
Warm-up time (Average)	11	sec

Peak Heater-Cathode Voltage:

Heater negative with respect to cathode. . . .	300 max.	volts
Heater positive with respect to cathode. . . .	200 ^a max.	volts

^a The dc component must not exceed 100 volts.



12X4

Full-Wave Vacuum Rectifier

The 12X4 is the same as the 6X4 except for the following items:

Heater Characteristics and Ratings:

Current.	0.300	amp
Voltage (AC or DC) at heater amperes = 0.300	12.6	volts

13CW4

High-Mu Triode

NUVISTOR TYPE

For Use as Grounded-Cathode, Neutralized RF-Amplifier
Tube in Tuners of VHF Television and FM Receivers

The 13CW4 is the same as the 6CW4 except for the following items:

Heater Characteristics and Ratings:

Current.	0.060	amp
Voltage (AC or DC) at heater amperes = 0.060	13.5	volts

13DE7

Dual Triode

With Medium-Mu Unit and Low-Mu Unit

9-PIN MINIATURE TYPE

The 13DE7 is the same as the 6DE7 except for the following items:

Heater Characteristics and Ratings:

Current.	0.450 ± 0.030	amp
Voltage (AC or DC) at heater amperes = 0.450	13.0	volts
Warm-up time (Average)	11	sec



13DR7

Dual Triode

With High-Mu Unit and Low-Mu Unit

The 13DR7 is the same as the 6DR7 except for the following items:

Heater Characteristics and Ratings:

Current.	0.450 ± 0.030	amp
Voltage (AC or DC) at heater amperes = 0.450	13.0	volts
Warm-up time (Average)	11	sec

13EM7

Dual Triode

With High-Mu Unit and Low-Mu Unit

The 13EM7 is the same as the 6EM7 except for the following items:

Heater Characteristics and Ratings:

Current.	0.450 ± 0.030	amp
Voltage (AC or DC) at heater amperes = 0.450	13.0	volts
Warm-up time (Average)	11	sec

13FD7

Dual Triode

With High-Mu Unit and Low-Mu Unit

The 13FD7 is the same as the 6FD7 except for the following items:

Heater Characteristics and Ratings:

Current.	0.450 ± 0.030	amp
Voltage (AC or DC) at heater amperes = 0.450	13.0	volts
Warm-up time (Average)	11	sec



13FM7

Dual Triode With High-Mu Unit and Low-Mu Unit

DUODECAR TYPE

The 13FM7 is the same as the 6FM7 except for the following items:

Heater Characteristics and Ratings

Current.	0.450 ± 0.030	A
Voltage (AC or DC) at 0.450 A.	13.0	V
Warm-up time (Average)	11	s

13GB5

Beam Power Tube

The 13GB5 is the same as the 6GB5 except for the following items:

Heater Characteristics and Ratings

Current.	0.600 ± 0.040	A
Voltage (AC or DC) at 0.600 A.	13.3	V

13GF7

Dual Triode With High-Mu Unit and Low-Mu Unit

NOVAR TYPE

The 13GF7 is the same as the 6GF7 except for the following items:

Heater Characteristics and Ratings

Current.	0.450 ± 0.030	A
Voltage (AC or DC) at 0.450 A.	13.0	V
Warm-up time (Average)	11	s



13GF7A

Dual Triode

With High-Mu Unit and Low-Mu Unit

NOVAR TYPE

The 13GF7A is the same as the 6GF7A except for the following items:

Heater Characteristics and Ratings

Current.	0.450 ± 0.030	A
Voltage (AC or DC) at 0.450 A.	13.0	V
Warm-up time (Average)	11	s

13J10

Pentode — Beam Power Tube

DUODECAR TYPE

The 13J10 is the same as the 6J10 except for the following items:

Heater Characteristics and Ratings

Current.	0.450 ± 0.030	A
Voltage (AC or DC) at 0.450 A.	13.2	V
Warm-up time (Average)	11	s

13Z10

Pentode — Beam Power Tube

DUODECAR TYPE

The 13Z10 is the same as the 6Z10 except for the following items:

Heater Characteristics and Ratings

Current.	0.450 ± 0.030	A
Voltage (AC or DC) at 0.450 A.	13.2	V
Warm-up time (Average)	11	s



Twin Diode—High-Mu Triode

9-PIN MINIATURE TYPE

GENERAL DATA

Electrical:

Heater, for Unipotential Cathodes:

Voltage (AC or DC)	14 ± 10%	volts
Current at 14 volts	0.15	amp

Direct Interelectrode Capacitances:▲

Triode Unit:

Grid to plate	1.8	μf
Grid to cathode and heater.	1.6	μf
Plate to cathode and heater	0.24	μf

Diode Units:

Diode-No.1 plate to triode grid	0.09 max.	μf
Diode-No.2 plate to triode grid	0.07 max.	μf
Either diode cathode to all other tube electrodes.	6.5	μf
Diode plate to cathode and heater (Each unit)	2.4	μf

Characteristics, Class A₁ Amplifier (Triode Unit):

Plate Voltage	250	volts
Grid Voltage.	-3	volts
Amplification Factor.	72	
Plate Resistance (Approx.).	72000	ohms
Transconductance.	1000	μmhos
Plate Current	0.7	ma

Mechanical:

Operating Position.	Any
Maximum Overall Length.	2-3/16"
Maximum Seated Length	1-15/16"
Length, Base Seat to Bulb Top (Excluding tip)	1-9/16" ± 3/32"
Diameter.	0.750" to 0.875"
Dimensional Outline	See <i>General Section</i>
Bulb.	T6-1/2
Base.	Small-Button Noval 9-Pin (JEDEC No.E9-1)
Basing Designation for BOTTOM VIEW.	9KR

- Pin 1—Diode-No.2 Cathode
- Pin 2—Diode-No.1 Plate
- Pin 3—Diode-No.1 Cathode
- Pin 4—Heater

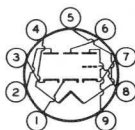

- Pin 5—Heater
- Pin 6—Diode-No.2 Plate
- Pin 7—Triode Cathode
- Pin 8—Triode Grid
- Pin 9—Triode Plate

TRIODE UNIT — AMPLIFIER — Class A₁

Maximum Ratings, Design-Maximum Values:

PLATE VOLTAGE.	330 max.	volts
------------------------	----------	-------



14GT8

GRID VOLTAGE:

Positive-bias value.	0	max.	volts
PLATE DISSIPATION.	1.1	max.	watts
PEAK HEATER-CATHODE VOLTAGE:			
Heater negative with respect to cathode. .	200	max.	volts
Heater positive with respect to cathode. .	200	max.	volts

DIODE UNITS — Two

Values are for Each Unit

Maximum Ratings, Design-Maximum Values:

PLATE CURRENT.	5	max.	ma
PEAK HEATER-CATHODE VOLTAGE:			
Heater negative with respect to cathode. .	200	max.	volts
Heater positive with respect to cathode. .	200	max.	volts

Characteristics, Instantaneous Test Condition:

Plate Current for plate volts = 5.	18	ma
--	----	----

▲ Without external shield.

● The dc component must not exceed 100 volts.



AVERAGE PLATE CHARACTERISTICS Triode Unit

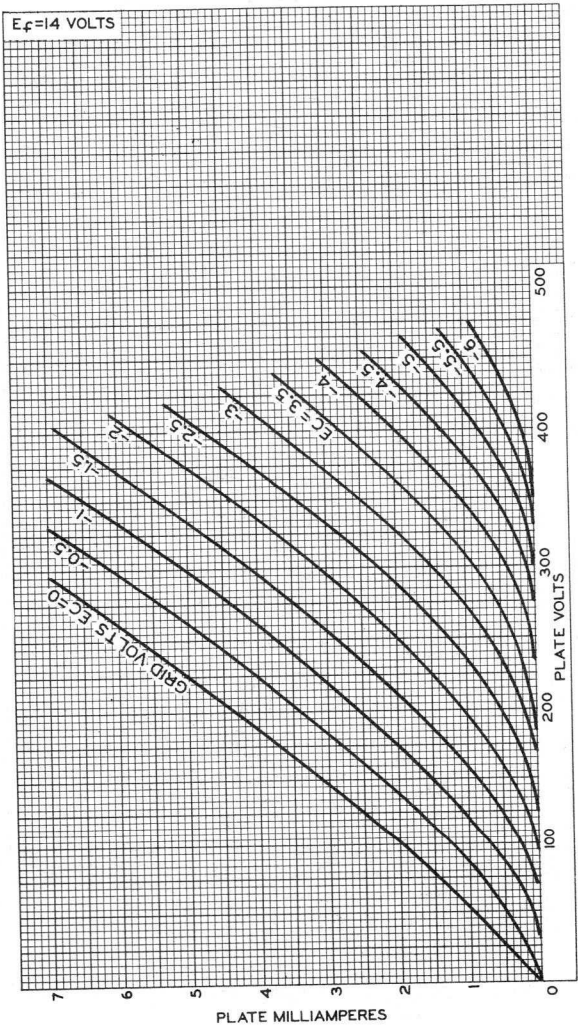

92CM-10835



14GT8

AVERAGE CHARACTERISTICS Triode Unit

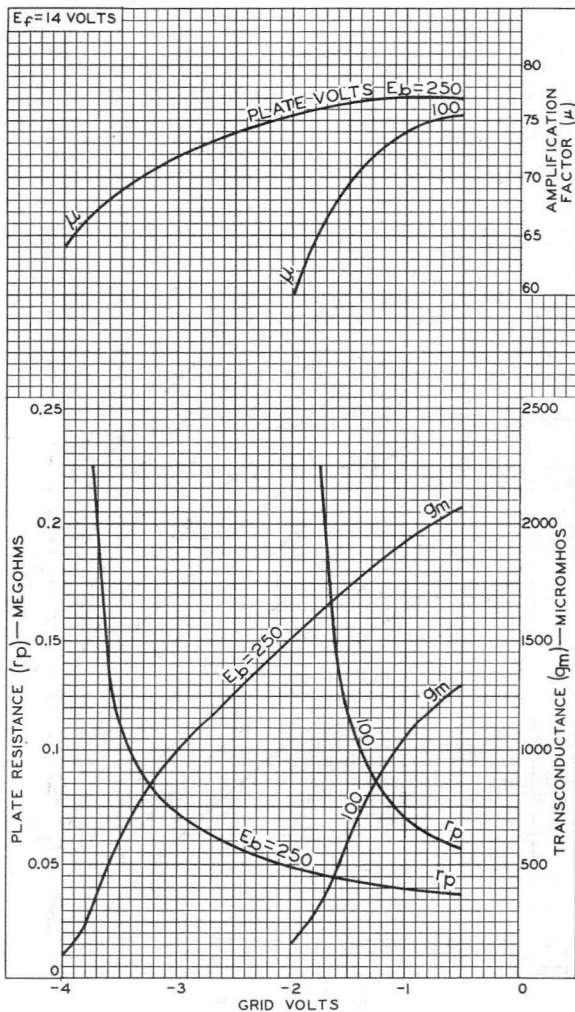

92CM-10838



15AF11

Dual Triode— Sharp-Cutoff Pentode

DUODECAR TYPE

The 15AF11 is the same as the 6AF11 except for the following items:

Heater Characteristics and Ratings:

Current.	0.450 ± 0.030	amp
Voltage (AC or DC) at 0.450 amp.	14.7	volts
Warm-up time (Average)	11	sec

15BD11

Dual Triode— Sharp-Cutoff Pentode

DUODECAR TYPE

The 15BD11 is the same as the 6BD11 except for the following items:

Heater Characteristics and Ratings:

Current.	0.450 ± 0.030	amp
Voltage (AC or DC) at 0.450 amp.	14.7	volts
Warm-up time (Average)	11	sec

15CW5

Beam Power Tube

The 15CW5 is the same as the 6CW5 except for the following items:

Heater Characteristics and Ratings:

Current.	0.300 ± 0.020	amp
Voltage (AC or DC) at 0.300 amp.	15.0	volts



15FM7

Dual Triode

DUODECAR TYPE

The 15FM7 is the same as the 6FM7 except for the following items:

Heater Characteristics and Ratings:

Current.	0.450 ± 0.030	amp
Voltage (AC or DC) at 0.450 amp.	14.8	volts
Warm-up time (Average)	11	sec

15FY7

Dual Triode

DUODECAR TYPE

The 15FY7 is the same as the 6FY7 except for the following items:

Heater Characteristics and Ratings:

Current.	0.450 ± 0.030	amp
Voltage (AC or DC) at 0.450 amp.	14.7	volts
Warm-up time (Average)	11	sec

15HB6

Power Pentode

The 15HB6 is the same as the 6HB6 except for the following items:

Heater Characteristics and Ratings:

Current.	0.300 ± 0.020	amp
Voltage (AC or DC) at 0.300 amp.	14.7	volts
Warm-up time (Average)	11	sec



High-Mu Triode— Beam Power Tube

NOVAR TYPE

For Combined Vertical-Deflection Oscillator
and Amplifier Service in TV Receivers

The 15KY8A is the same as the 6KY8A except for the following items:

Heater Characteristics and Ratings:

Current	0.450 ± 0.030	amp
Voltage (AC or DC) at heater amperes = 0.450	15.0	volts
Warm-up time (Average)	11	sec





16GK6

Power Pentode

9-PIN MINIATURE TYPE

The 16GK6 is the same as the 6GK6 except for the following items:

Heater Characteristics and Ratings:

Current.	0.300 ± 0.020	amp
Voltage (AC or DC) at heater amperes = 0.300	16.0	volts
Warm-up time (Average)	11	sec

17AX3

Half-Wave Vacuum Rectifier

DUODECAR TYPE

The 17AX3 is the same as the 6AX3 except for the following items:

Heater Characteristics and Ratings:

Current.	0.450 ± 0.030	amp
Voltage (AC or DC) at heater amperes = 0.450	16.8	volts
Warm-up time (Average)	11	sec

17AX4GTA

Half-Wave Vacuum Rectifier

For TV Damper Service

The 17AX4GTA is the same as the 6AX4GTB except for the following items:

Heater Characteristics and Ratings:

Current.	0.450 ± 0.030	amp
Voltage (AC or DC) at heater amperes = 0.450	16.8	volts
Warm-up time (Average)	11	sec



17AY3, 17AY3A

Half-Wave Vacuum Rectifier

NOVAR TYPE

For TV Dampener Service

The 17AY3 and 17AY3A are the same as the 6AY3 and 6AY3B, respectively, except for the following items:

Heater Characteristics and Ratings:

Current	0.450 ± 0.030	amp
Voltage (AC or DC) at heater amperes = 0.450	16.8	volts
Warm-up time (Average)	11	sec

17BE3

Half-Wave Vacuum Rectifier

DUODECAR TYPE

The 17BE3 is the same as the 6BE3 except for the following items:

Heater Characteristics and Ratings:

Current	0.450 ± 0.030	amp
Voltage (AC or DC) at heater amperes = 0.450	16.8	volts
Warm-up time (Average)	11	sec

17BF11

Beam Power Tube— Sharp-Cutoff Pentode

DUODECAR TYPE

The 17BF11 is the same as the 6BF11 except for the following items:

Heater Characteristics and Ratings:

Current	0.450 ± 0.030	amp
Voltage (AC or DC) at heater amperes = 0.450	16.8	volts
Warm-up time (Average)	11	sec



17BH3A

Half-Wave Vacuum Rectifier

NOVAR TYPE

For TV Damper Service

The 17BH3A is the same as the 6BH3A except for the following items:

Heater Characteristics and Ratings

Current.	0.600 ± 0.040	A
Voltage (AC or DC) at 0.600 A.	17	V
Warm-up time (Average)	11	s

17BS3A

Half-Wave Vacuum Rectifier

NOVAR TYPE

For TV Damper Service

The 17BS3A is the same as the 6BS3A except for the following items:

Heater Characteristics and Ratings

Current.	0.450 ± 0.030	A
Voltage (AC or DC) at 0.450 A.	16.8	V
Warm-up time (Average)	11	s

17CK3

Half-Wave Vacuum Rectifier

NOVAR TYPE

For TV Damper Service

The 17CK3 is the same as the 6CK3 except for the following items:

Heater Characteristics and Ratings

Current.	0.450 ± 0.030	A
Voltage (AC or DC) at 0.450 A.	16.8	V
Warm-up time (Average)	11	s

17CT3

Half-Wave Vacuum Rectifier

9-PIN MINIATURE TYPE
For TV Damper Service

The 17CT3 is the same as the 6CT3 except for the following items:

Heater Characteristics and Ratings

Current	0.450 ± 0.030	A
Voltage (AC or DC) at 0.450 A	16.8	V
Warm-up time (Average)	11	s

17CU5

Beam Power Tube

7-PIN MINIATURE TYPE

The 17CU5 is the same as the 6CU5 except for the following items:

Heater Characteristics and Ratings

Current	0.450 ± 0.030	A
Voltage (AC or DC) at 0.450 A	16.8	V
Warm-up time (Average)	11	s

17D4

Half-Wave Vacuum Rectifier

For TV Damper Service

The 17D4 is the same as the 6DA4 except for the following items:

Heater Characteristics and Ratings

Current	0.450 ± 0.030	A
Voltage (AC or DC) at 0.450 A	16.8	V
Warm-up time (Average)	11	s

17DE4

Half-Wave Vacuum Rectifier

For TV Damper Service

The 17DE4 is the same as the 6DE4 except for the following items:

Heater Characteristics and Ratings

Current	0.600 ± 0.040	A
Voltage (AC or DC) at 0.600 A	17	V
Warm-up time (Average)	11	s

17DM4A

Half-Wave Vacuum Rectifier

For Television Damper Service

Electrical:

Heater Characteristics and Ratings:

Current	0.450 ± 0.030	amp
Voltage (AC or DC) at heater amperes = 0.450	16.8	volts
Warm-up time (Average)	11	sec
Maximum heater-cathode voltage:		
Heater negative with respect to cathode ^a		
Peak	5000	volts
DC component	900	volts
Heater positive with respect to cathode		
Peak	300	volts
DC component	100	volts

Direct Interelectrode Capacitances (Approx.):

P to (K,H)	8.5	pf
K to (P,H)	11.5	pf
Heater to cathode.	4.0	pf

Mechanical:

Operating Position	Any
Type of Cathode.	Coated Unipotential
Maximum Overall Length	3-13/16"
Maximum Seated Length.	3-1/4"
Maximum Diameter	1-9/32"
Bulb	T9
Base	Short Intermediate-Shell Octal 5-Pin (JEDEC No. B5-85)
Basing Designation for BOTTOM VIEW	4CG

- Pin 2 - Do Not Use^b
- Pin 3 - Cathode
- Pin 5 - Plate
- Pin 7 - Heater
- Pin 8 - Heater

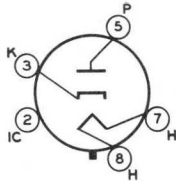

DAMPER SERVICE

Maximum Ratings, Design-Maximum Values:

For operation in a 525-line, 30-frame system^c

Peak Inverse Plate Voltage ^a	5000	volts
Peak Plate Current	1200	ma
DC Plate Current	200	ma
Plate Dissipation.	6.5	watts

Characteristics, Instantaneous Value:

Tube Voltage Drop for plate ma = 400	35	volts
--	----	-------

^a This rating is applicable when the duty cycle of the voltage pulse does not exceed 15 per cent of one horizontal scanning cycle. In a 525-line, 30 frame system, 15 per cent of one horizontal scanning cycle is 10 microseconds.



17DM4A

- b Socket terminals 1, 2, 4 and 6 should not be used as tie points.
 c As described is "Standards of Good Engineering Practice Concerning Television Broadcast Stations," Federal Communications Commission.

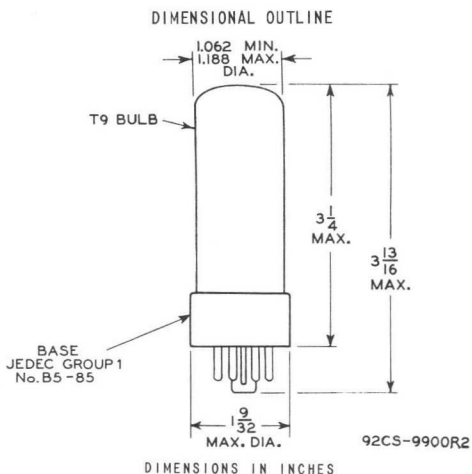

AVERAGE PLATE CHARACTERISTIC

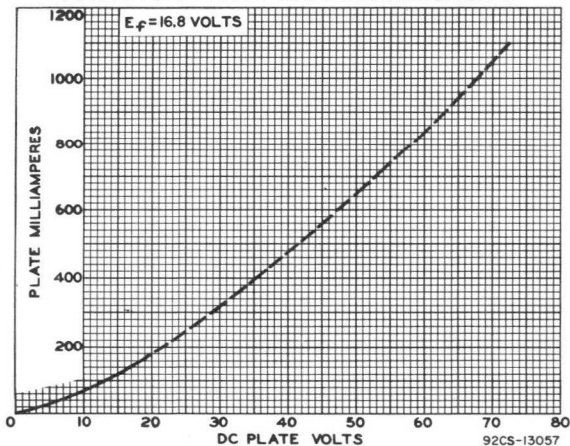

17GJ5A

Beam Power Tube

NOVAR TYPE

The 17GJ5A is the same as the 6GJ5A except for:

Heater Characteristics and Ratings

Current	0.450 ± 0.030 A
Voltage (AC or DC) at 0.450 A	16.8 V
Warm-up time (Average)	11 s

17GW6/17DQ6B

Beam Power Tube

NOVAR TYPE

The 17GW6/17DQ6B is the same as the 6GW6 except for:

Heater Characteristics and Ratings

Current	0.450 ± 0.030 A
Voltage (AC or DC) at 0.450 A	16.8 V
Warm-up time (Average)	11 s

17JB6A

Beam Power Tube

NOVAR TYPE

The 17JB6A is the same as the 6JB6A except for:

Heater Characteristics and Ratings

Current	0.450 ± 0.030 A
Voltage (AC or DC) at 0.450 A	16.8 V
Warm-up time (Average)	11 s

17JF6

Beam Power Tube

NOVAR TYPE

The 17JF6 is the same as the 6JF6 except for:

Heater Characteristics and Ratings

Current600 ± 0.040 A
Voltage (AC or DC) at 0.600 A	16.8 V
Warm-up time (Average)	11 s

17JG6A

Beam Power Tube

NOVAR TYPE

The 17JG6A is the same as the 6JG6A except for:

Heater Characteristics and Ratings

Current600 ± 0.040 A
Voltage (AC or DC) at 0.600 A	16.8 V
Warm-up time (Average)	11 s

17JQ6

Beam Power Tube With an Integral Diode

The 17JQ6 is the same as the 6JQ6 except for:

Heater Characteristics and Ratings

Current	0.450 ± 0.030	A
Voltage (ac or dc) at 0.450 A	17.0	V
Warm-up time (Average)	11	s

17JR6

Beam Power Tube

Novar Type

The 17JR6 is the same as the 6JR6 except for:

Heater Characteristics and Ratings

Current	0.600 ± 0.040	A
Voltage (ac or dc) at 0.600 A	16.8	V
Warm-up time (Average)	11	s

17JT6A

Beam Power Tube

Novar Type

The 17JT6A is the same as the 6JT6A except for:

Heater Characteristics and Ratings

Current	0.450 ± 0.030	A
Voltage (ac or dc) at 0.450 A	16.8	V
Warm-up time (Average)	11	s

17JZ8

Medium-Mu Triode— Beam Power Tube

Duodecar Type

The 17JZ8 is the same as the 6JZ8 except for:

Heater Characteristics and Ratings

Current	0.450 ± 0.030	A
Voltage (ac or dc) at 0.450 A	16.8	V
Warm-up time (Average)	11	s

17KV6

Beam Power Tube

Novar Type

The 17KV6 is the same as the 6KV6 except for:

Heater Characteristics and Ratings

Current	0.600 ± 0.040	A
Voltage (ac or dc) at 0.600A	16.8	V
Warm-up time (Average)	11	s

17KV6A

Beam Power Tube

Novar Type

The 17KV6A is the same as the 6KV6A except for:

Heater Characteristics and Ratings

Current	0.600 ± 0.040	A
Voltage (ac or dc) at 0.600A	16.8	V
Warm-up time (Average)	11	s

Remote-Cutoff Pentode

7-PIN MINIATURE TYPE

With Heater Having Controlled Warm-Up Time

GENERAL DATA

Electrical:

Heater, for Unipotential Cathode:

Voltage (AC or DC)	18	volts
Current	0.1 ± 6%	amp
Warm-up time (Average)	20	sec

Direct Interelectrode Capacitances:^a

Grid No.1 to plate	0.0035 max.	μf
Grid No.1 to cathode, grid No.3, grid No.2, and heater	5.5	μf
Plate to cathode, grid No.3, grid No.2, and heater	5	μf

Characteristics, Class A₁ Amplifier:

Plate Supply Voltage	100	volts
Grid No.3	<i>Connected to cathode at socket</i>	
Grid-No.2 Supply Voltage	100	volts
Cathode Resistor	68	ohms
Plate Resistance (Approx.)	0.25	megohm
Transconductance	4400	μmhos
Plate Current	11	ma
Grid-No.2 Current	4.4	ma
Grid-No.1 Voltage (Approx.) for transconductance (μmhos) = 25	-20	volts

Mechanical:

Operating Position	Any
Maximum Overall Length	2-1/8"
Maximum Seated Length	1-7/8"
Length, Base Seat to Bulb Top (Excluding tip)	1-1/2" ± 3/32"
Diameter	0.650" to 0.750"
Dimensional Outline	See <i>General Section</i>
Bulb	T5-1/2
Base	Small-Button Miniature 7-Pin (JEDEC No.E7-1)
Basing Designation for BOTTOM VIEW	7CC

Pin 1-Grid No.1
Pin 2-Grid No.3,
Internal
Shield
Pin 3-Heater

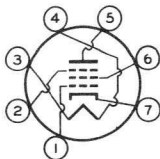

Pin 4-Heater
Pin 5-Plate
Pin 6-Grid No.2
Pin 7-Cathode



18FW6A

AMPLIFIER — Class A₁

Maximum Ratings, Design-Maximum Values:

PLATE VOLTAGE 150 max. volts

GRID No.3 (SUPPRESSOR GRID) *Connected to cathode at socket*

GRID-No.2 (SCREEN-GRID) SUPPLY VOLTAGE. . . 150 max. volts

GRID-No.2 VOLTAGE *See Grid-No.2 Input Rating Chart*
at front of Receiving Tube Section

GRID-No.2 INPUT:

For grid-No.2 voltages up to 75 volts . . 0.6 max. watt

For grid-No.2 voltages between 75

and 150 volts *See Grid-No.2 Input Rating Chart*
at front of Receiving Tube Section

PLATE DISSIPATION 2.5 max. watts

PEAK HEATER-CATHODE VOLTAGE:

Heater negative with respect to cathode . 100 max. volts

Heater positive with respect to cathode . 100 max. volts

^a With external shield JEDEC No.316 connected to cathode.



AVERAGE CHARACTERISTICS

$E_f = 18$ VOLTS
 PLATE VOLTS = 100
 GRID No 3 CONNECTED TO
 CATHODE AT SOCKET.
 GRID-No 2 VOLTS = 100

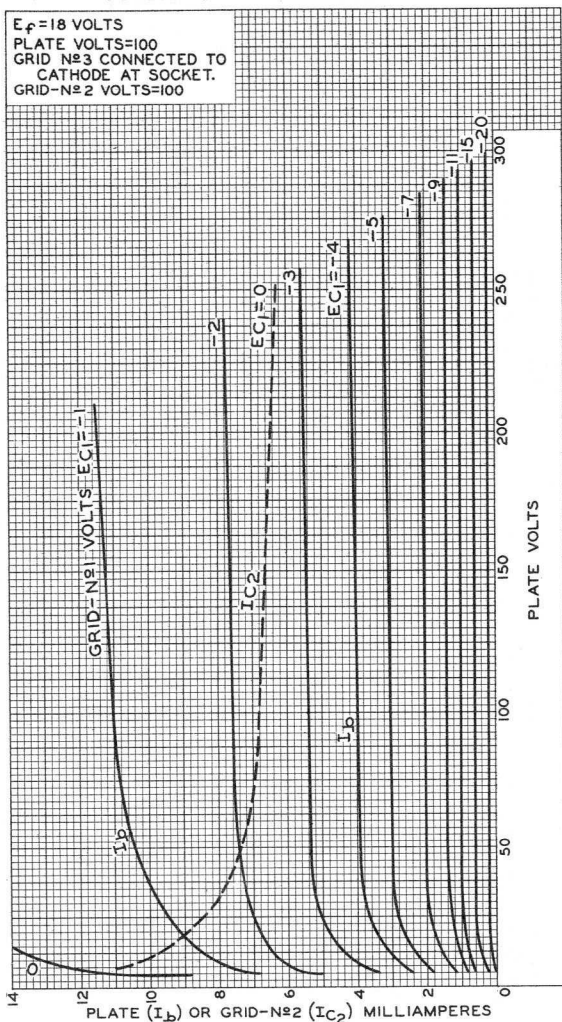

92CM-10778



RADIO CORPORATION OF AMERICA
 Electron Tube Division

Harrison, N. J.

DATA 2
 7-61

18FW6A

AVERAGE CHARACTERISTICS

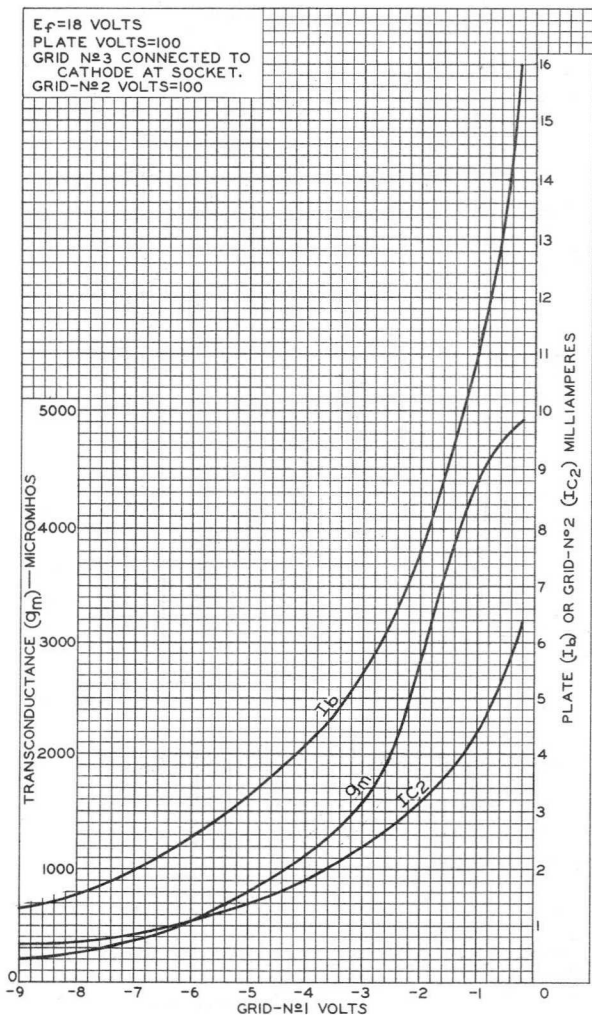

92CM-10776



Pentagrid Converter

7-PIN MINIATURE TYPE

With Heater Having Controlled Warm-Up Time

GENERAL DATA

Electrical:

Heater, for Unipotential Cathode:

Voltage (AC or DC)	18	volts
Current	0.1 ± 6%	amp
Warm-up time (Average)	20	sec

Direct Interelectrode Capacitances:

	<i>Without External Shield</i>	<i>With External Shield^a</i>	
Grid No.3 to all other elec- trodes (RF input)	7	7	μf
Plate to all other electrodes (Mixer input)	8	13	μf
Grid No.1 to all other elec- trodes (Oscillator input) . . .	5.5	5.5	μf
Grid No.3 to plate	0.3 max.	0.25 max.	μf
Grid No.3 to grid No.1	0.15 max.	0.15 max.	μf
Grid No.1 to plate	0.1	0.05	μf
Grid No.1 to cathode & grid No.5 .	3	3	μf
Cathode & grid No.5 to all other electrodes except grid No.1 . .	15	20	μf

Mechanical:

Operating Position	Any
Maximum Overall Length	2-1/8"
Maximum Seated Length	1-7/8"
Length, Base Seat to Bulb Top (Excluding tip) . .	1-1/2" ± 3/32"
Diameter	0.650" to 0.750"
Dimensional Outline	See <i>General Section</i>
Bulb	T5-1/2
Base	Small-Button Miniature 7-Pin (JEDEC No. E7-1)
Basing Designation for BOTTOM VIEW	7CH

Pin 1 - Grid No.1
Pin 2 - Cathode,
Grid No.5
Pin 3 - Heater
Pin 4 - Heater

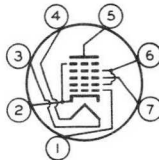

Pin 5 - Plate
Pin 6 - Grid No.2,
Grid No.4
Pin 7 - Grid No.3

CONVERTER

Maximum Ratings, Design-Maximum Values:

PLATE VOLTAGE	150 max.	volts
GRIDS-No. 2 & No. 4 (SCREEN-GRIDS) SUPPLY VOLTAGE .	150 max.	volts



18FX6A

GRIDS-No.2 & No.4 VOLTAGE.	110 max.	volts
GRIDS-No.2 & No.4 INPUT.	1.2 max.	watts
PLATE DISSIPATION.	1 max.	watt
PEAK HEATER-CATHODE VOLTAGE:		
Heater negative with respect to cathode.	100 max.	volts
Heater positive with respect to cathode.	100 max.	volts

Characteristics:

With Separate Excitation^b

Plate Voltage.	100	volts
Grids-No.2 & No.4 Voltage.	100	volts
Grid-No.3 Voltage.	-1.5	volts
Grid-No.1 Resistor	20000	ohms
Plate Resistance (Approx.)	0.4	megohm
Conversion Transconductance.	480	μ mhos
Plate Current.	2.3	ma
Grids-No.2 & No.4 Current.	6.2	ma
Grid-No.1 Current.	0.5	ma
Total Cathode Current.	9	ma
Grid-No.3 Voltage (Approx.) for conversion transconductance (μ mhos) = 10	-21	volts

Oscillator Characteristics (Not Oscillating):^c

Plate & Grids-No.2 & No.4 Voltage.	100	volts
Grid-No.3 Voltage.	0	volts
Grid-No.1 Voltage.	0	volts
Amplification Factor ^d	22	
Oscillator Transconductance ^d	7000	μ mhos
Cathode Current.	24	ma
Grid-No.1 Voltage (Approx.) for plate $\mu a = 20$	-9.2	volts

^a With external shield JEDEC No.316 connected to cathode.

^b The characteristics shown with separate excitation correspond very closely with those obtained in a self-excited-oscillator circuit operating with zero bias.

^c With grids No.2 & No.4 connected to plate.

^d Between grid No.1 and grids No.2 & No.4 connected to plate.



AVERAGE CHARACTERISTICS

$E_f = 18$ VOLTS
 PLATE VOLTS = 100
 GRIDS - No 2 & No 4 VOLTS = 100
 GRID - No 1 MILLIAMPERES = 0.5
 GRID - No 1 RESISTOR (OHMS) = 20 000
 SEPARATE EXCITATION.

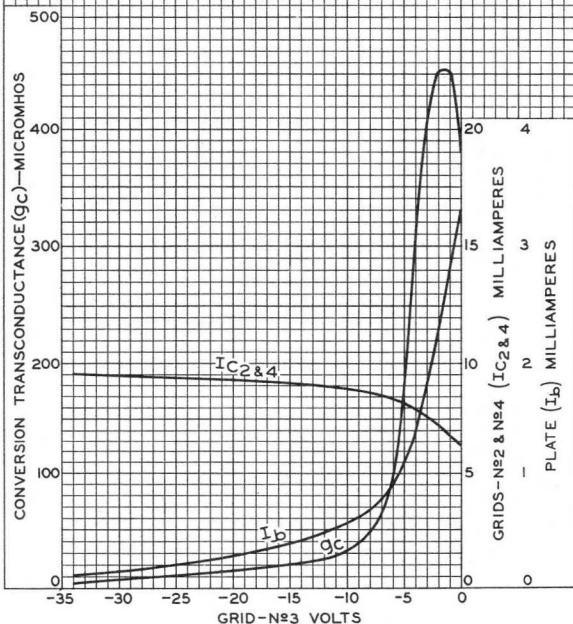

92CM-10777



18FX6A

AVERAGE CHARACTERISTICS

$E_f = 18$ VOLTS
PLATE VOLTS = 100
GRIDS - N^o 2 & N^o 4 VOLTS = 100
GRID - N^o 3 VOLTS = -1.5
GRID - N^o 1 RESISTOR (OHMS) = 20000
SEPARATE EXCITATION.

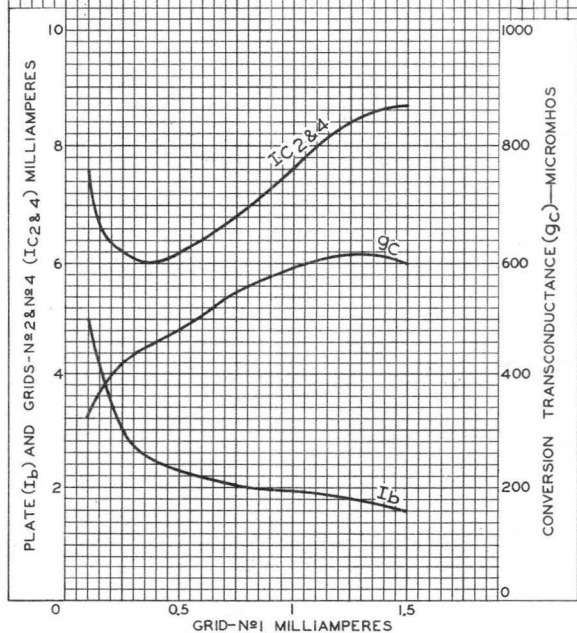

92CM-10782



Twin Diode—High-Mu Triode

7-PIN MINIATURE TYPE

With Heater Having Controlled Warm-Up Time

GENERAL DATA

Electrical:

Heater, for Unipotential Cathode:

Voltage (AC or DC)	18	volts
Current	0.1 ± 6%	amp
Warm-up time (Average)	20	sec

Direct Interelectrode Capacitances:

	<i>Without External Shield</i>	<i>With External Shield^a</i>	
Triode grid to triode plate . .	1.8	1.8	μf
Triode grid to cathode and heater.	2.4	2.4	μf
Triode plate to cathode and heater.	0.22	2	μf
Plate of diode unit No.2 to triode grid.	0.2 max.	0.2 max.	μf

Characteristics, Class A₁ Amplifier (Triode Unit):

Plate Voltage	100	volts
Grid Voltage	-1	volt
Amplification Factor	100	
Plate Resistance (Approx.)	77000	ohms
Transconductance	1300	μmhos
Plate Current	0.6	ma

Mechanical:

Operating Position	Any
Maximum Overall Length	2-1/8"
Maximum Seated Length	1-7/8"
Length, Base Seat to Bulb Top (Excluding tip) . .	1-1/2" ± 3/32"
Diameter	0.650" to 0.750"
Dimensional Outline	See <i>General Section</i>
Bulb	T5-1/2
Base	Small-Button Miniature 7-Pin (JEDEC No. E7-1)
Basing Designation for BOTTOM VIEW	7BT

- Pin 1—Grid of Triode Unit
- Pin 2—Cathode of Triode Unit and Diode Units No.1 and No.2
- Pin 3—Heater
- Pin 4—Heater

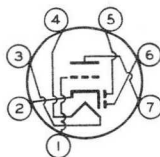

- Pin 5—Plate of Diode Unit No.2
- Pin 6—Plate of Diode Unit No.1
- Pin 7—Plate of Triode Unit



18FY6A

TRIODE UNIT — AMPLIFIER — Class A₁

Maximum Ratings, *Design-Maximum Values:*

PLATE VOLTAGE	150 max.	volts
GRID VOLTAGE:		
Positive-bias value	0 max.	volts
PLATE DISSIPATION	0.5 max.	watt
PEAK HEATER-CATHODE VOLTAGE:		
Heater negative with respect to cathode.	100 max.	volts
Heater positive with respect to cathode.	100 max.	volts

DIODE UNITS — Two

Maximum Ratings, *Design-Maximum Values:*

Values are for Each Unit

PLATE CURRENT	1 max.	ma
-------------------------	--------	----

Characteristics, *Instantaneous Test Condition:*

Plate Current for plate volts = 10.	2	ma
---	---	----

^a With external shield JEDEC No.316 connected to cathode.



AVERAGE PLATE CHARACTERISTICS Triode Unit

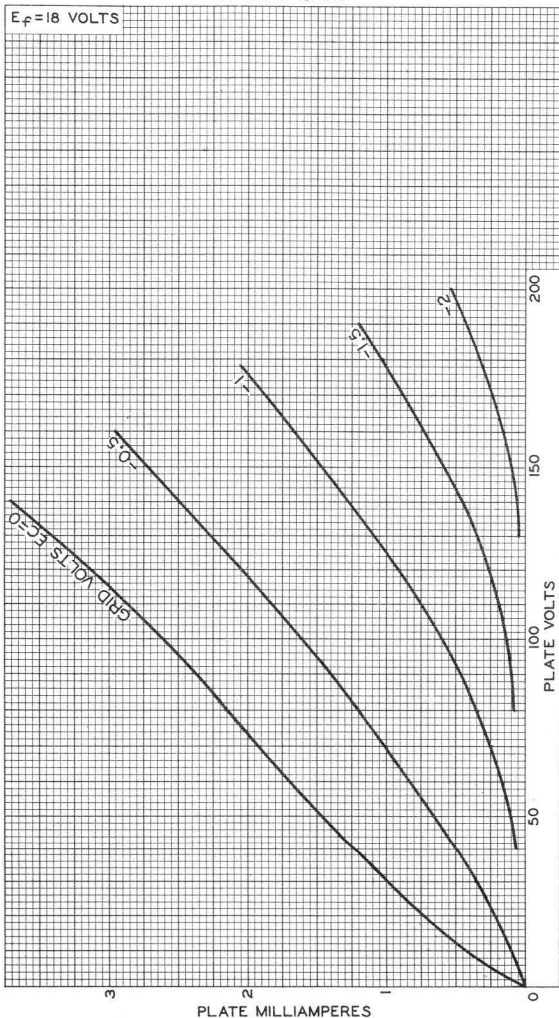

92CM-10775





Sharp-Cutoff Pentode

7-PIN MINIATURE TYPE

With Heater Having Controlled Warm-Up Time

GENERAL DATA

Electrical:

Heater, for Unipotential Cathode:

Voltage (AC or DC)	18	volts
Current	0.1 ± 6%	amp
Warm-up time (Average)	20	sec

Direct Interelectrode Capacitances:

	<i>Without External Shield</i>	<i>With External Shield^a</i>	
Grid No.1 to plate.	0.0035 max.	0.0035 max.	μf
Grid No.1 to cathode, grid No.3 & internal shield, grid No.2, and heater.	6	6	μf
Plate to cathode, grid No.3 & internal shield, grid No.2, and heater.	5	5	μf

Characteristics, Class A₁ Amplifier:

Plate Supply Voltage.	100	volts
Grid No.3	<i>Connected to cathode at socket</i>	
Grid-No.2 Supply Voltage.	100	volts
Cathode Resistor.	150	ohms
Plate Resistance (Approx.)	0.5	megohm
Transconductance.	4300	μmhos
Plate Current	5	ma
Grid-No.2 Current	2	ma
Grid-No.1 Voltage (Approx.) for plate μ a = 10	-4.7	volts

Mechanical:

Operating Position.	Any
Maximum Overall Length.	2-1/8"
Maximum Seated Length	1-7/8"
Length, Base Seat to Bulb Top (Excluding tip)	1-1/2" ± 3/32"
Diameter.	0.650" to 0.750"
Dimensional Outline	See <i>General Section</i>
Bulb.	T5-1/2
Base.	Small-Button Miniature 7-Pin (JEDEC No. E7-1)



18GD6A

Basing Designation for BOTTOM VIEW. 7BK

Pin 1 - Grid No.1
Pin 2 - Grid No.3,
Internal
Shield
Pin 3 - Heater

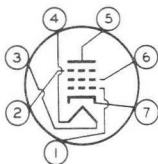

Pin 4 - Heater
Pin 5 - Plate
Pin 6 - Grid No.2
Pin 7 - Cathode

RF AMPLIFIER and AUTODYNE CONVERTER

Maximum Ratings, Design-Maximum Values:

PLATE VOLTAGE 150 max. volts
GRID No.3 (SUPPRESSOR GRID) . . .Connect to cathode at socket
GRID-No.2 (SCREEN-GRID) SUPPLY VOLTAGE. . . 150 max. volts
GRID-No.2 VOLTAGESee Grid-No.2 Input Rating
Chart at front of Receiving Tube Section

GRID-No.2 INPUT:

For grid-No.2 voltages up to 75 volts . . . 0.6 max. watt
For grid-No.2 voltages between
75 and 150 volts.See Grid-No.2 Input Rating
Chart at front of Receiving Tube Section

PLATE DISSIPATION 2.5 max. watts

PEAK HEATER-CATHODE VOLTAGE:

Heater negative with respect to cathode . . 100 max. volts
Heater positive with respect to cathode . . 100 max. volts

^a With external shield JEDEC No.316 connected to cathode.



AVERAGE CHARACTERISTICS

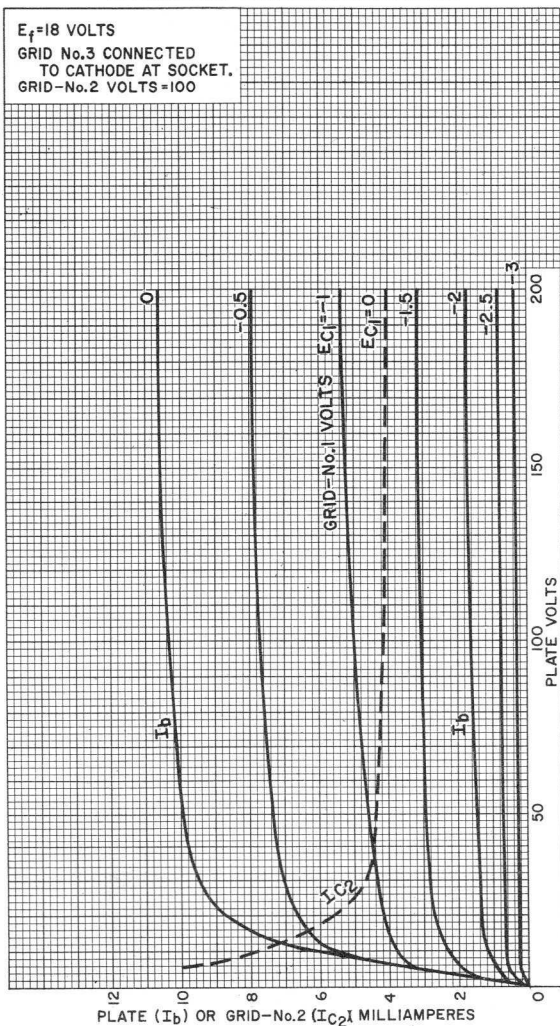

92CM-11138RI



18GD6A

AVERAGE CHARACTERISTICS

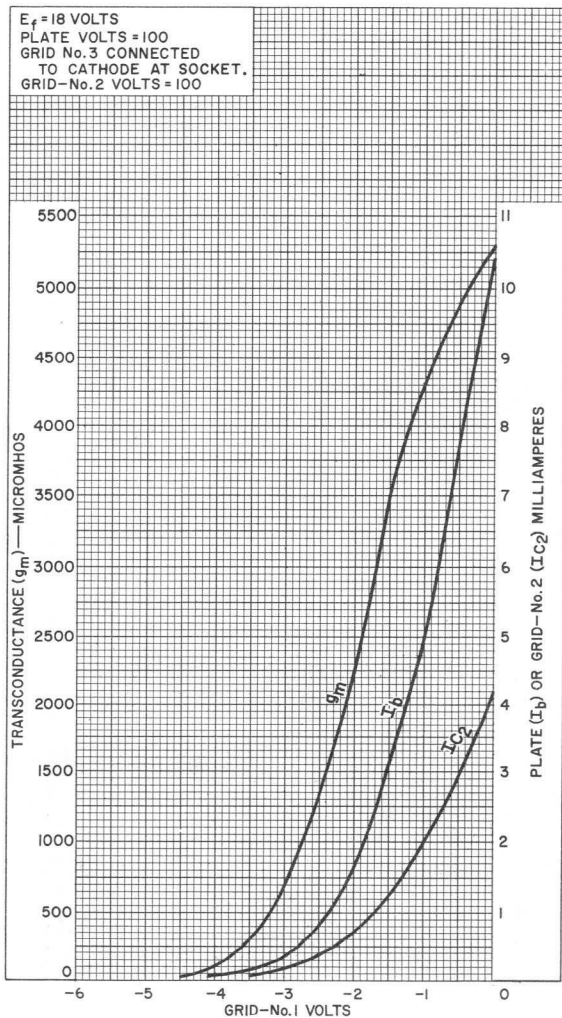

92CM-11136RI



19CG3

Half-Wave Vacuum Rectifier

Duodecar Type

The 19CG3 is the same as the 6CG3 except for:

Heater Characteristics and Ratings

Current	0.600 ± 0.040 A
Voltage (ac or dc) at 0.600 A	19.0 V
Warm-up time (Average)	11 s

19CL8A

Medium-Mu Triode— Sharp-Cutoff Tetrode

9-Pin Miniature Type

Controlled Heater Warm-up Time

The 19CL8A is the same as the 6CL8A except for:

Heater Characteristics and Ratings

Current	0.150 ± 0.010 A
Voltage (ac or dc) at 0.150 A	18.9 V

19EA8

Medium-Mu Triode— Sharp-Cutoff Pentode

9-Pin Miniature Type

Controlled Heater Warm-up Time

The 19EA8 is the same as the 6EA8 except for:

Heater Characteristics and Ratings

Current	0.150 ± 0.010 A
Voltage (ac or dc) at 0.150 A	18.9 V

**Electronic
Components**

DATA
8-70

19FX5

Power Pentode

7-Pin Miniature Type

The 19FX5 is the same as the 60FX5 except for:

Heater Characteristics and Ratings

Current	0.300 ± 0.020 A
Voltage (ac or dc) at 0.300 A	18.9 V
Warm-up time (Average)	11 s

19HR6

Semiremote-Cutoff Pentode

7-Pin Miniature Type

The 19HR6 is the same as the 6HR6 except for:

Heater Characteristics and Ratings

Current	0.150 ± 0.010 A
Voltage (ac or dc) at 0.150 A	18.9 V
Warm-up time (Average)	17 s

19HS6

Sharp-Cutoff Pentode

7-Pin Miniature Type

The 19HS6 is the same as the 6HS6 except for:

Heater Characteristics and Ratings

Current	0.150 ± 0.010 A
Voltage (ac or dc) at 0.150 A	18.9 V
Warm-up time (Average)	17 s

High-Mu Twin Triode

9-PIN MINIATURE TYPE

For High-Gain, Resistance-Coupled, Low-Level Audio-Amplifiers Operating at Low-Signal Levels, such as Preamplifiers for Low-Cost Stereophonic Phonographs

GENERAL DATA

Electrical:

Heater, for Unipotential Cathodes:

Voltage (AC or DC)	20	volts
Current	$0.1 \pm 6\%$	amp

Direct Interelectrode Capacitances (Approx.):^a

	Unit No. 1	Unit No. 2	
Grid to plate	1.5	1.5	$\mu\mu\text{f}$
Grid to cathode and heater	1.6	1.6	$\mu\mu\text{f}$
Plate to cathode and heater	0.2	0.3	$\mu\mu\text{f}$

Characteristics, Class A₁ Amplifier (Each Unit):

Plate Voltage	100	250	volts
Grid Voltage	-1	-2	volts
Amplification Factor	100	100	
Plate Resistance (Approx.)	8000	62500	ohms
Transconductance	1250	1600	μmhos
Plate Current	0.5	1.2	ma

Mechanical:

Operating Position	Any
Maximum Overall Length	2-3/16"
Maximum Seated Length	1-15/16"
Length, Base Seat to Bulb Top (Excluding tip)	1-9/16" \pm 3/32"
Diameter	0.750" to 0.875"
Dimensional Outline	See <i>General Section</i>
Bulb	T6-1/2
Base	Small-Button Noval 9-Pin (JEDEC No. E9-1)

Basing Designation for BOTTOM VIEW 9PG

Pin 1-Heater

Pin 2-Heater

Pin 3-Internal Connection—Do Not Use

Pin 4-Cathode of Unit No. 2

Pin 5-Grid of Unit No. 2

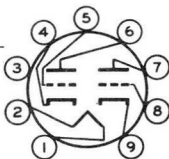

Pin 6-Plate of Unit No. 2

Pin 7-Plate of Unit No. 1

Pin 8-Grid of Unit No. 1

Pin 9-Cathode of Unit No. 1

AMPLIFIER — Class A₁

Values are for Each Unit

Maximum Ratings, Design-Maximum Values:

PLATE VOLTAGE	330 max.	volts
-------------------------	----------	-------

← Indicates a change.



20EZ7

GRID VOLTAGE:

Negative-bias value. 55 max. volts

Positive-bias value. 0 max. volts

PLATE DISSIPATION. 1.2 max. watts

PEAK HEATER-CATHODE VOLTAGE:

Heater negative with respect to cathode. . 200 max. volts

Heater positive with respect to cathode. . 200^b max. volts

Typical Operation as Resistance-Coupled Amplifier:

See *RESISTANCE-COUPLED-AMPLIFIER CHART No. 25*
at front of this Section

^a Without external shield.

^b The dc component must not exceed 100 volts.



AVERAGE PLATE CHARACTERISTICS Each Unit

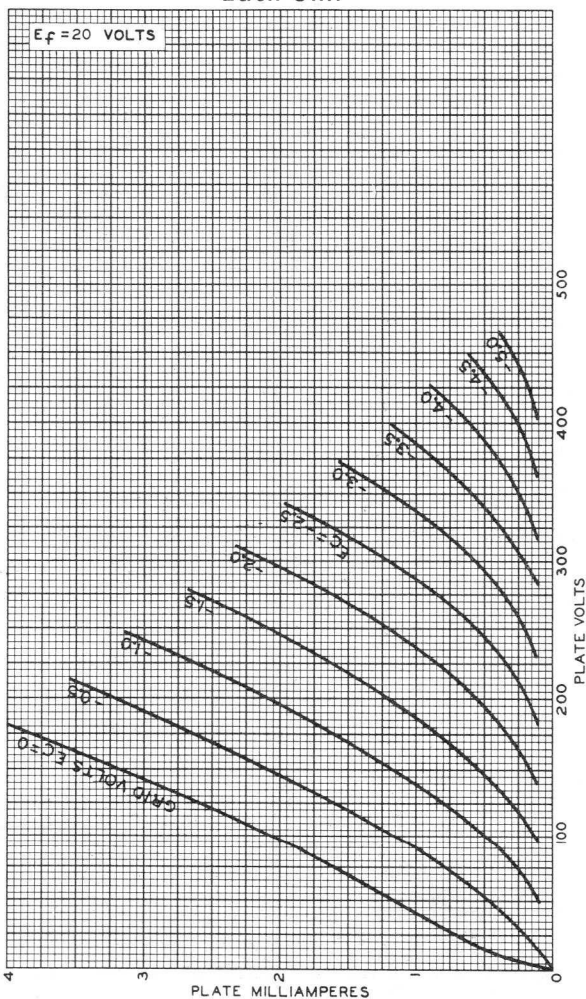

92CM-10804



20E7Z

AVERAGE CHARACTERISTICS Each Unit

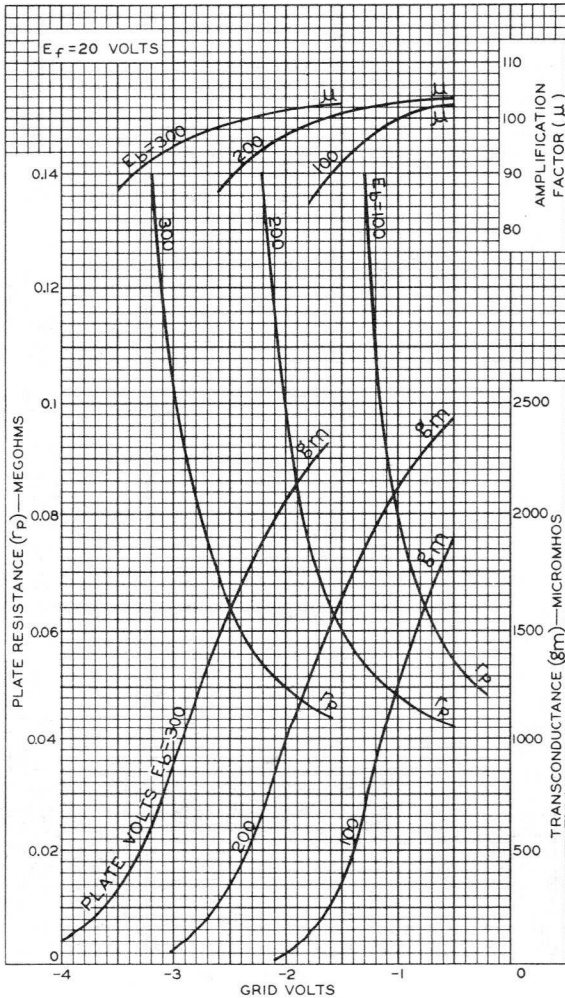

92CM-10805

RADIO CORPORATION OF AMERICA
Electron Tube Division

Harrison, N. J.



High-Mu Triode—Beam Power Tube

NOVAR TYPE

For Combined Vertical-Deflection Oscillator and Amplifier Service in Color TV Receivers

ELECTRICAL CHARACTERISTICS

Bogey Values

Heater Current	I_f	450	mA
Heater Voltage (AC or DC) at $I_f = 450$ mA	E_f	21.0	V
Heater Warm-up Time (Average).		11	s
Direct Interelectrode Capacitances (Approx.)			
Without external shield			
<i>Triode Unit:</i>			
Grid to plate.	C_{gp}	6.0	pF
Input: G_T to (KT, H).	C_i	6.5	pF
Output: P_T to (KT, H).	C_o	1.6	pF
<i>Beam Power Unit:</i>			
Grid No.1 to plate	C_{gp}	0.7 max	pF
G_{1B} to ($K_B + G_{3B}$, G_{2B} , H).	C_i	16.0	pF
P_B to ($K_B + G_{3B}$, G_{2B} , H).	C_o	9.0	pF
G_{1B} to P_T		0.12 max	pF
P_B to P_T		0.32 max	pF
Basing Designation for BOTTOM VIEW			9QT

- Pin 1—Triode Cathode
- Pin 2—Beam Power Grid No.1
- Pin 3—Beam Power Cathode & Grid No.3
- Pin 4—Heater
- Pin 5—Heater
- Pin 6—Beam Power Plate
- Pin 7—Beam Power Grid No.2
- Pin 8—Triode Plate
- Pin 9—Triode Grid

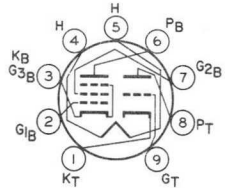

CLASS A₁ AMPLIFIER

For the following characteristics, see Conditions

		Triode Unit		Beam Power Unit		
Amplification Factor	μ	58	-	-	6.5 ^a	
Plate Resistance (Approx.)	r_p	16000	-	12000	-	Ω
Transconductance	g_m	3600	-	9300	-	μmhos
DC Plate Current	I_b	2.3	200 ^b	56	-	mA
DC Grid-No.2 Current	I_g	-	20 ^b	3	-	mA
Cutoff DC Grid-No.1 Voltage						
$I_b = 10 \mu\text{A}$	$E_c(\text{co})$	-6.6	-	-	-	V
$I_b = 1$ mA (Approx.)	$E_c(\text{co})$	-	-	-26	-	V
$I_b = 100 \mu\text{A}$	$E_c(\text{co})$	-	-	-30	-	V



21LR8

Conditions

		Triode Unit		Beam Power Unit		
Heater Voltage	E_f	21.0	21.0	21.0	21.0	V
Plate Voltage	E_b	250	45	135	120	V
Grid-No.2 Voltage	E_c	-	125	120	120	V
Grid-No.1 Voltage	E_c	-4	0	-10	-10	V

MECHANICAL CHARACTERISTICS

Operating Position		Any
Type of Cathodes		Coated Unipotential
Maximum Overall Length (l_m)		3.710 in
Maximum Seated Length (l_m)		3.330 in
Length, Base Seat to Bulb Top (Excluding tip)		2.810 to 2.990 in
Diameter (d)		1.438 to 1.562 in
Envelope		T12
Bases (alternates)		

Small-Button Novar 9-Pin (JEDEC No.E9-76)

Small-Button Novar 9-Pin with Exhaust Tip 9-Pin

(JEDEC No.E9-88)

VERTICAL-DEFLECTION OSCILLATOR (Triode Unit)

Maximum Ratings, Design-Maximum Values

For operation in a 525-line, 30-frame system

DC Plate Voltage	E_b	400	V
Peak Negative-Pulse Grid Voltage	e_{cm}	400	V
Peak Cathode Current	i_{km}	105	mA
Average Cathode Current	$i_{k(av)}$	30	mA
Plate Dissipation	P_b	2.5	W
Peak Power Output	P_o	2.5	W

Maximum Circuit Values

Grid-Circuit Resistance	$R_g(ckt)$	2.2	M Ω
For grid-resistor-bias operation			

VERTICAL-DEFLECTION AMPLIFIER (Beam Power Unit)

Maximum Ratings, Design-Maximum Values

For operation in a 525-line, 30-frame system

DC Plate Voltage	E_b	400	V
Peak Positive-Pulse Plate Voltage ^c	e_{bm}	2500 ^d	V
DC Grid-No.2 (Screen-Grid) Voltage	E_c	300	V
Peak Negative-Pulse Grid-No.1 (Control-Grid) Voltage	e_{cm}	250	V
Peak Cathode Current	i_{km}	260	mA
Average Cathode Current	$i_{k(av)}$	75	mA
Plate Dissipation ^e	P_b	14	W
Grid-No.2 Input ^e	P_c	2.75	W
Envelope Temperature	T_E	210	°C

MAXIMUM CIRCUIT VALUES

Grid-Circuit Resistance	$R_g(ckt)$	1	M Ω
For fixed-bias operation			
For grid-resistor-bias operation		2.2	M Ω



- a Triode connection.
- b This value can be measured by a method involving a recurrent wave form such that the plate dissipation and grid-No. 2 input will be kept within ratings in order to prevent damage to the tube.
- c This rating is applicable where the duration of the voltage pulse does not exceed 15 per cent of one vertical scanning cycle. In a 525-line, 30-frame system, 15 per cent of one vertical scanning cycles is 2.5 milliseconds.
- d Absolute Maximum value.
- e An adequate bias resistor or other means is required to protect the tube in the absence of excitation.

DIMENSIONAL OUTLINE
Top Exhaust (JEDEC No. 12-65)

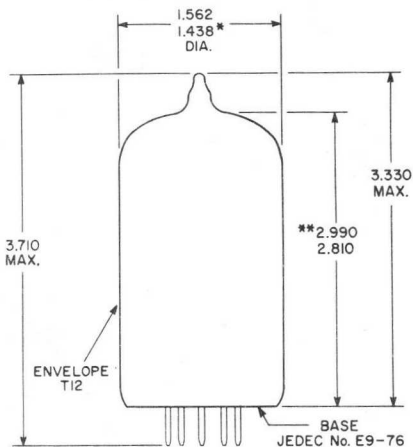

92CS-13502A

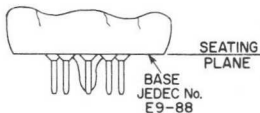

92CS-11127R3B

DIMENSIONS IN INCHES

Bottom-exhaust version has the same dimensions for maximum overall length and seated length as the top-exhaust outline shown.

- * Applies to the minimum diameter except in the area of the seal.
- ** Measured from the base seat to bulb-top line as determined by arcing gauge of 0.600" I.D.



Typical Characteristics Triode Unit

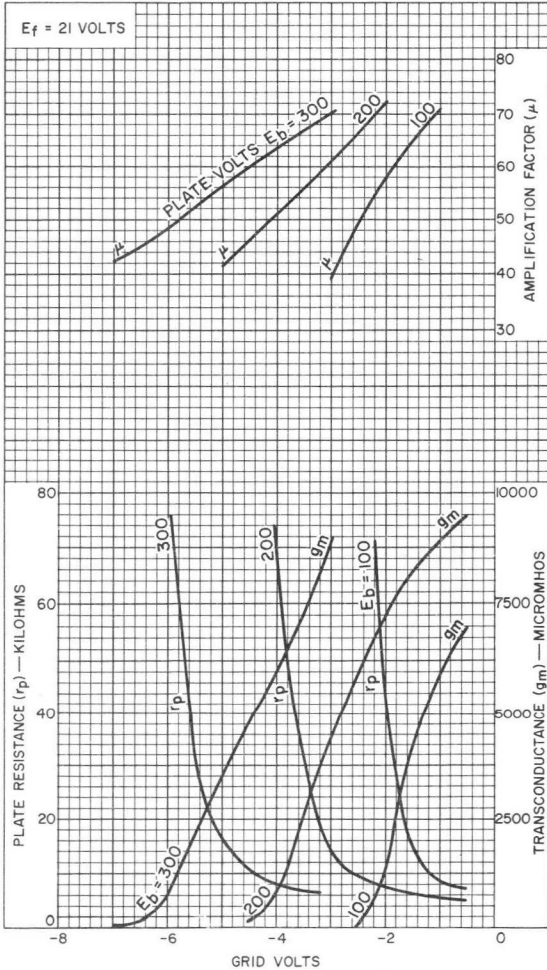

92CM-13506



Typical Plate Characteristics

Triode Unit

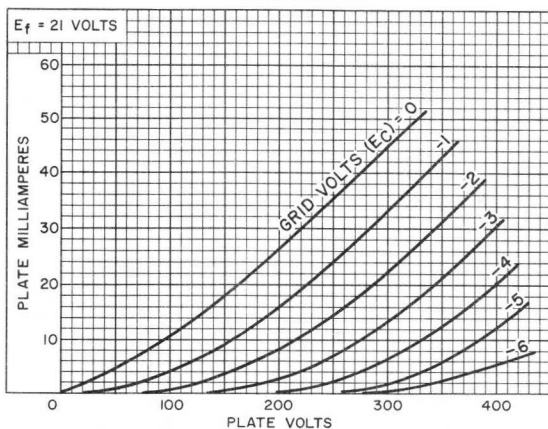

92CS-13508

Typical Characteristics

Beam Power Unit

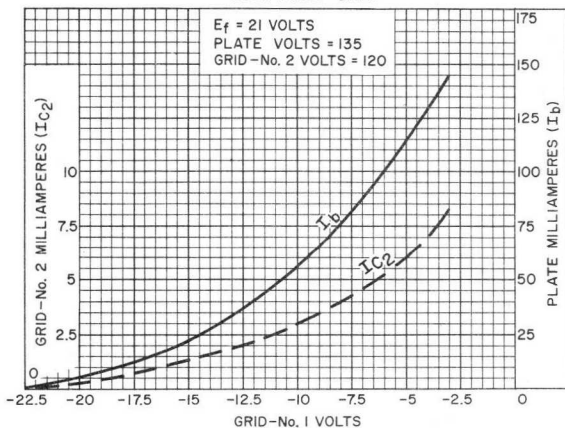

92CS-13509



Typical Characteristics

Beam Power Unit

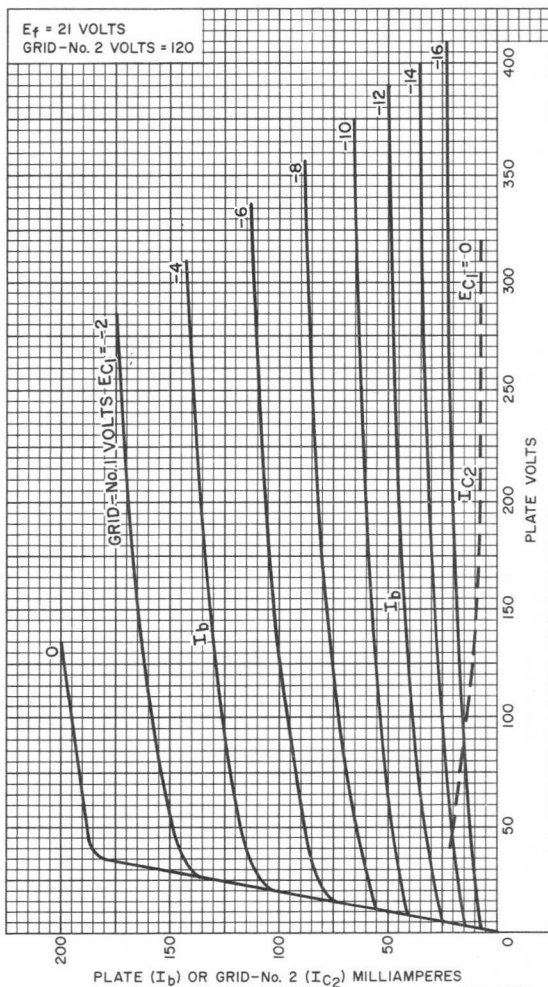

92CM-13507



22BH3

Half-Wave Vacuum Rectifier

NOVAR TYPE

For TV Damper Service

The 22BH3 is the same as the 6BH3 except for the following items:

Heater Characteristics and Ratings

Current.	I_h	0.450 ± 0.030	A
Voltage (AC or DC) at 0.450A. . .	E_h	22.4	V
Warm-up time (Average)		11	s

22BH3A

Half-Wave Vacuum Rectifier

NOVAR TYPE

For TV Damper Service

The 22BH3A is the same as the 6BH3A except for the following items:

Heater Characteristics and Ratings

Current.	I_h	0.450 ± 0.030	A
Voltage (AC or DC) at 0.450A. . .	E_h	22.4	V
Warm-up time (Average)		11	s

22DE4

Half-Wave Vacuum Rectifier

For TV Damper Service

The 22DE4 is the same as the 6DE4 except for the following items:

Heater Characteristics and Ratings

Current.	I_h	0.450 ± 0.030	A
Voltage (AC or DC) at 0.450A. . .	E_h	22.4	V
Warm-up time (Average)		11	s



22JF6

Beam Power Tube

NOVAR TYPE

For Horizontal-Deflection-Amplifier Service
in Low-B+, Black-and-White TV Receivers

The 22JF6 is the same as the 6JF6 except for the following items:

Heater Characteristics and Ratings

Current	I_h	0.450 ± 0.030	A
Voltage (AC or DC) at 0.450A	E_h	22.0	V
Warm-up time (Average)		11	s



22JG6A

Beam Power Tube

Novar Type

The 22JG6A is the same as the 6JG6A except for:

Heater Characteristics and Ratings

Current	0.450 ± 0.030	A
Voltage (ac or dc) at 0.450 A	22.0	V
Warm-up time (Average)	11	s

22JR6

Beam Power Tube

Novar Type

The 22JR6 is the same as the 6JR6 except for:

Heater Characteristics and Ratings

Current	0.450 ± 0.030	A
Voltage (ac or dc) at 0.450 A	22.0	V
Warm-up time (Average)	11	s

22JU6

Beam Power Tube

Novar Type

The 22JU6 is the same as the 6JU6 except for:

Heater Characteristics and Ratings

Current	0.450 ± 0.030	A
Voltage (ac or dc) at 0.450 A	22.0	V
Warm-up time (Average)	11	s

22KM6

Beam Power Tube

Novar Type

The 22KM6 is the same as the 6KM6 except for:

Heater Characteristics and Ratings

Current	0.450 ± 0.030	A
Voltage (ac or dc) at 0.450 A	22.0	V
Warm-up time (Average)	11	s

22KV6A

Beam Power Tube Novar Type

The 22KV6A is the same as the 6KV6A except for:

Heater Characteristics and Ratings

Current	0.450 ± 0.030	A
Voltage (ac or dc) at 0.450 A	22.0	V
Warm-up time (Average)	11	s

24JE6A

Beam Power Tube Novar Type

The 24JE6A is the same as the 6JE6A except for:

Heater Characteristics and Ratings

Current	0.600 ± 0.040	A
Voltage (ac or dc) at 0.600 A	24.0	V
Warm-up time (Average)	11	s

24LQ6

Beam Power Tube Novar Type

The 24LQ6 is the same as the 6LQ6 except for:

Heater Characteristics and Ratings

Current	0.600 ± 0.040	A
Voltage (ac or dc) at 0.600 A	24.0	V
Warm-up time (Average)	11	s



25AV5-GA BEAM POWER TUBE

25AV5-GA
TO
25BQ6-GTB

The 25AV5-GA is the same as the 6AV5-GA except for the following items:

Heater, for Unipotential Cathode:			
Voltage (AC or DC)	25	volts	
Current	0.3	amp	

25AX4-GT HALF-WAVE VACUUM RECTIFIER

For television damper service

The 25AX4-GT is the same as the 6AX4-GT except for the following items:

Heater, for Unipotential Cathode:			
Voltage (AC or DC)	25	volts	
Current	0.3	amp	

25BK5 BEAM POWER TUBE

9-PIN MINIATURE TYPE

The 25BK5 is the same as the 6BK5 except for the following items:

Heater, for Unipotential Cathode:			
Voltage (AC or DC)	25	volts	
Current	0.3	amp	

25BQ6-GTB/25CU6 BEAM POWER TUBE

The 25BQ6-GTB/25CU6 is the same as the 6BQ6-GTB/6CU6 except for the following items:

Heater, for Unipotential Cathode:			
Voltage (AC or DC)	25	volts	
Current	0.3	amp	

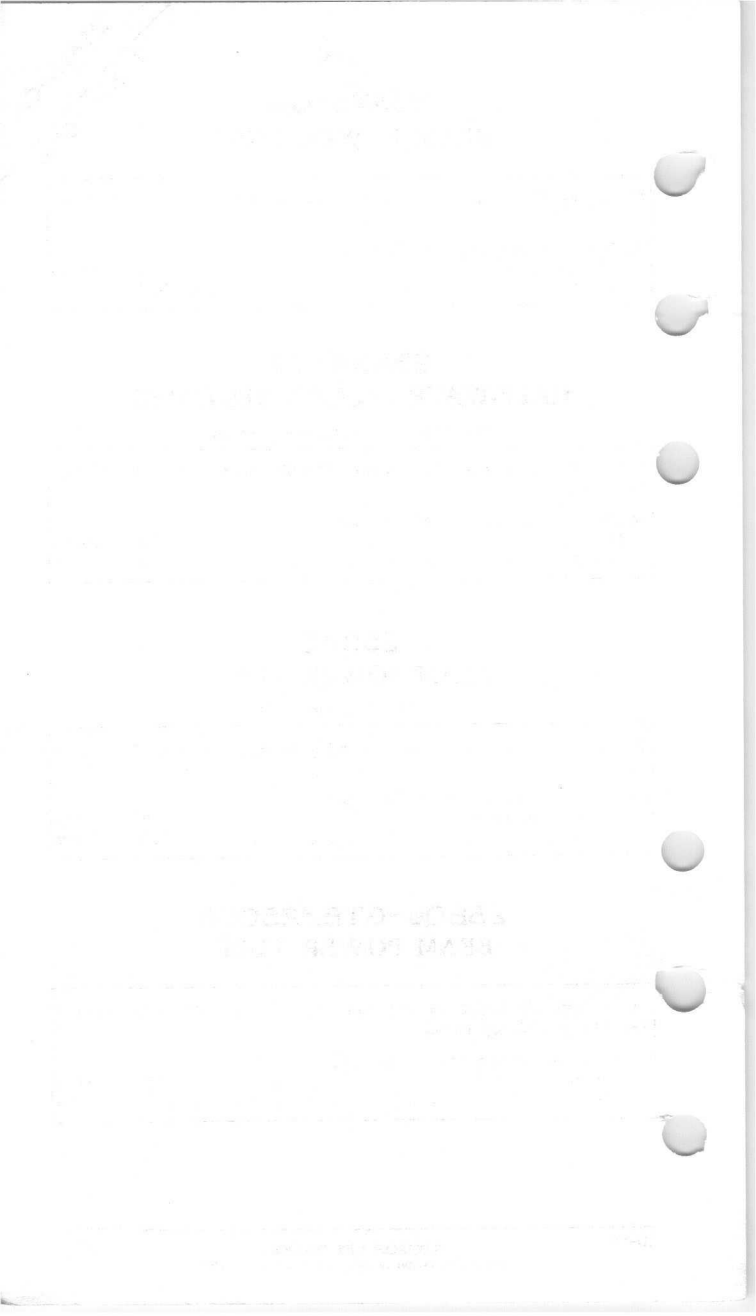



25C5

25C5

BEAM POWER TUBE

7-PIN MINIATURE TYPE

GENERAL DATA

Electrical:

Heater, for Unipotential Cathode:

Voltage	25	ac or dc volts
Current	0.3	amp

Direct Interelectrode Capacitances (Approx.)^o:

Grid No.1 to plate.	0.6	μ f
Grid No.1 to cathode & grid No.3, grid No.2 and heater.	13	μ f
Plate to cathode & grid No.3, grid No.2 and heater.	8.5	μ f

Mechanical:

Operating Position.	Any
Maximum Overall Length.	2-5/8"
Maximum Seated Length.	2-3/8"
Length, Base Seat to Bulb Top (Excluding tip)	2" \pm 3/32"
Maximum Diameter.	3/4"
Dimensional Outline	See General Section
Bulb.	T5-1/2
Base.	Small-Button Miniature 7-Pin (JETEC No.E7-1)
Basing Designation for BOTTOM VIEW.	7CV

Pin 1 - Cathode,
Grid No.3
Pin 2 - Grid No.1
Pin 3 - Heater

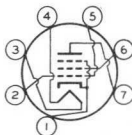

Pin 4 - Heater
Pin 5 - Grid No.1
Pin 6 - Grid No.2
Pin 7 - Plate

AMPLIFIER — Class A₁

Maximum Ratings, Design-Center Values:

PLATE VOLTAGE	135	max.	volts
GRID-No.2 (SCREEN-GRID) VOLTAGE	117	max.	volts
GRID-No.1 (CONTROL-GRID) VOLTAGE:			
Positive bias value	0	max.	volts
GRID-No.2 INPUT	1.25	max.	watts
PLATE DISSIPATION	6	max.	watts
PEAK HEATER-CATHODE VOLTAGE:			
Heater negative with respect to cathode.	200	max.	volts
Heater positive with respect to cathode.	200*	max.	volts
BULB TEMPERATURE (At hottest point on bulb surface).	220	max.	°C

Typical Operation and Characteristics:

Plate Voltage	120	volts
Grid-No.2 Voltage	110	volts
Grid-No.1 Voltage	-8	volts

^o,*: see next page.

25C5



25C5

BEAM POWER TUBE

Peak AF Grid-No.1 Voltage.	8	volts
Zero-Signal Plate Current.	49	ma
Max.-Signal Plate Current.	50	ma
Zero-Signal Grid-No.2 Current.	4	ma
Max.-Signal Grid-No.2 Current.	8.5	ma
Plate Resistance (Approx.)	10000	ohms
Transconductance	7500	μ mhos
Load Resistance.	2500	ohms
Total Harmonic Distortion.	10	%
Max.-Signal Power Output	2.3	watts

Maximum Circuit Values:

Grid-No.1-Circuit Resistance:

For fixed-bias operation	0.1 max.	megohm
For cathode-bias operation	0.5 max.	megohm

^o without external shield.

* The dc component must not exceed 100 volts.



25C5

25C5

AVERAGE CHARACTERISTICS

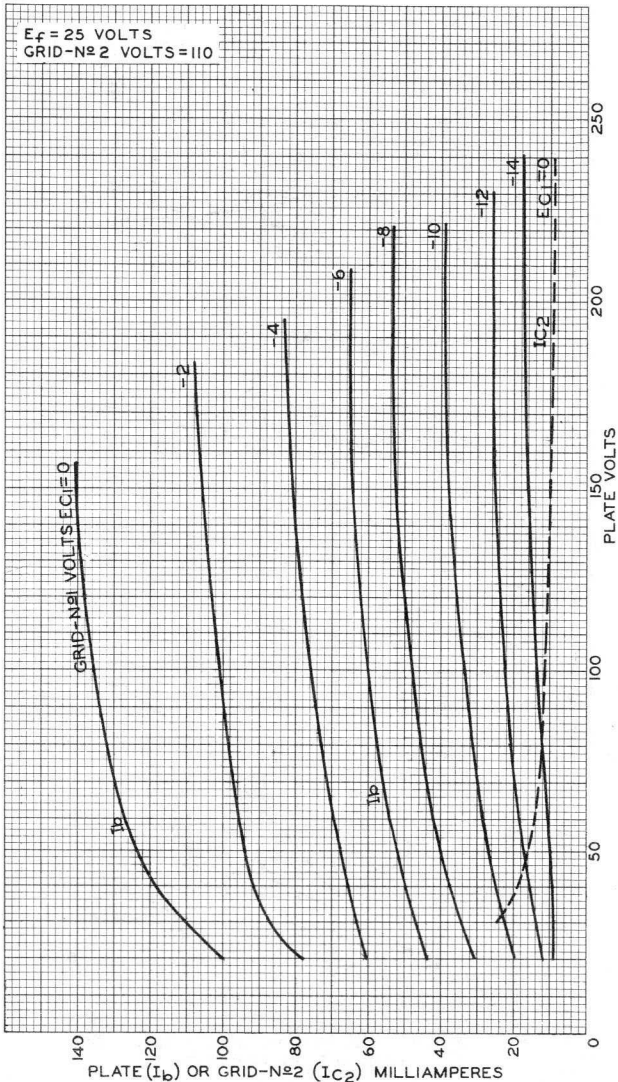

ELECTRON TUBE DIVISION

92CM-8908R2

RADIO CORPORATION OF AMERICA, HARRISON, NEW JERSEY

25C5



25C5

OPERATION CHARACTERISTICS

$E_f = 25$ VOLTS PLATE VOLTS = 120 GRID-N^o2 VOLTS = 110
 GRID-N^o1 VOLTS = -8 SIGNAL VOLTS (RMS) = 5.7

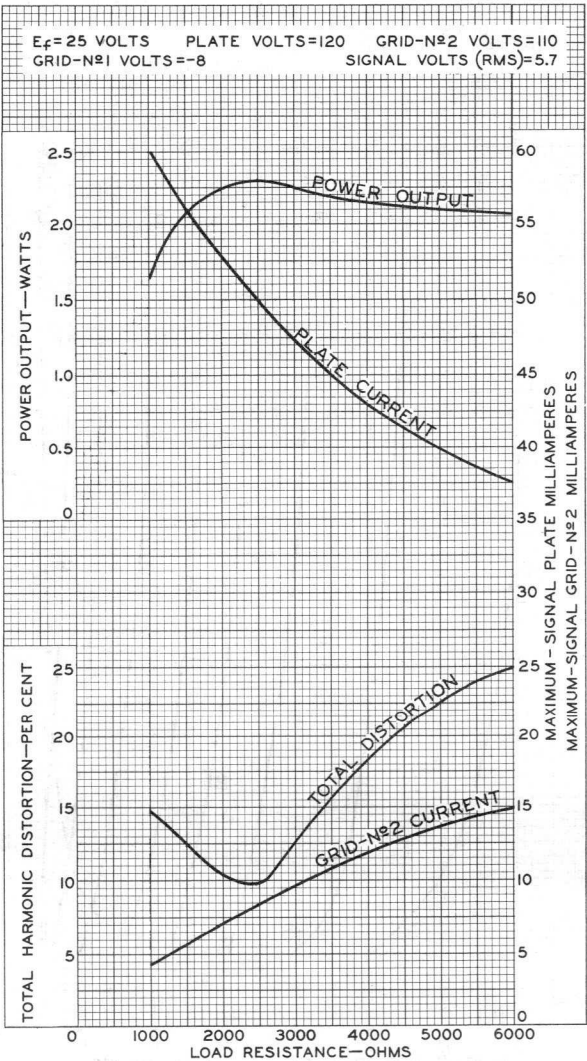

ELECTRON TUBE DIVISION

92CM-8918RI

RADIO CORPORATION OF AMERICA, HARRISON, NEW JERSEY

25CD6GB

Beam Power Tube

The 25CD6GB is the same as the 6CD6GA except for:

Heater Characteristics and Ratings

Current	0.600 A
Voltage (ac or dc),	25.0 V
Warm-up time (Average)	11 s

25CG3

Half-Wave Vacuum Rectifier

Duodecar Type

The 25CG3 is the same as the 6CG3 except for:

Heater Characteristics and Ratings

Current	0.450 ± 0.030 A
Voltage (ac or dc) at 0.450 A	25.0 V
Warm-up time (Average)	11 s

25CK3

Half-Wave Vacuum Rectifier

Novar Type

The 25CK3 is the same as the 6CK3 except for:

Heater Characteristics and Ratings

Current	0.300 ± 0.020 A
Voltage (ac or dc) at 0.300 A	25.2 V
Warm-up time (Average)	11 s

25CM3

Half-Wave Vacuum Rectifier

Novar Type

The 25CM3 is the same as the 6CM3 except for:

Heater Characteristics and Ratings

Current	0.600 ± 0.040 A
Voltage (ac or dc) at 0.600 A	25.0 V
Warm-up time (Average)	11 s

25CT3

Half-Wave Vacuum Rectifier

9-Pin Miniature Type

The 25CT3 is the same as the 6CT3 except for:

Heater Characteristics and Ratings

Current	0.300 ± 0.020 A
Voltage (ac or dc) at 0.300 A	25.2 V
Warm-up time (Average)	11 s



25DN6

25DN6

BEAM POWER TUBE

Intended for use in equipment having series heater-string arrangement

GENERAL DATA

Electrical:

Heater, for Unipotential Cathode:

Voltage.	25	ac or dc volts
Current.	0.6	amp
Warm-up time (Average)	11	sec

For definition of heater warm-up time and method of determining it, see sheet HEATER WARM-UP TIME MEASUREMENT at front of this Section.

Direct Interelectrode Capacitances (Approx.):⁰

Grid No.1 to plate	0.8	$\mu\mu\text{f}$
Grid No.1 to cathode & grid No.3, grid No.2, and heater.	22	$\mu\mu\text{f}$
Plate to cathode & grid No.3, grid No.2, and heater	11.5	$\mu\mu\text{f}$

Characteristics, Class A₁ Amplifier:

Plate Voltage.	50	125	volts
Grid-No.2 (Screen-Grid) Voltage.	100	125	volts
Grid-No.1 (Control-Grid) Voltage	0	-18	volts
Mu Factor, Grid No.2 to Grid No.1.	-	4.35	
Plate Resistance (Approx.)	-	4000	ohms
Transconductance	-	9000	μmhos
Plate Current.	240*	70	ma
Grid-No.2 Current.	30*	6.3	ma
Grid-No.1 Voltage (Approx.) for plate current of 0.5 ma.	-	-36	volts

Mechanical:

- Operating Position Vertical, base up or down, or Horizontal with pins 1 and 3 in vertical plane
- Maximum Overall Length 5"
- Seated Length. 4-1/4" \pm 3/16"
- Maximum Diameter 1-9/16"
- Bulb T12
- Cap. Small (JETEC No.C1-1)
- Base Short Medium-Shell Octal 8-Pin with External Barriers, Style B (JETEC No.B8-118)
- Basing Designation for BOTTOM VIEW 5BT

- Pin 1 - No Connection
- Pin 2 - Heater
- Pin 3 - Cathode, Grid No.3
- Pin 4 - No Connection

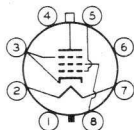

- Pin 5 - Grid No.1
- Pin 6 - No Connection
- Pin 7 - Heater
- Pin 8 - Grid No.2
- Cap - Plate

⁰ *: See next page.



25DN6

BEAM POWER TUBE

HORIZONTAL DEFLECTION AMPLIFIER

Maximum Ratings, Design-Center Values Except as Noted:

For operation in a 525-line, 30-frame system[□]

DC PLATE VOLTAGE	700	max.	volts
PEAK POSITIVE-PULSE PLATE VOLTAGE (Absolute maximum) [⊕]	6600 [■]	max.	volts
PEAK NEGATIVE-PULSE PLATE VOLTAGE.	1500	max.	volts
DC GRID-No.2 (SCREEN-GRID) VOLTAGE	175	max.	volts
PEAK NEGATIVE-PULSE GRID-No.1 VOLTAGE.	200	max.	volts
CATHODE CURRENT:			
Peak	700	max.	ma
Average.	200	max.	ma
GRID-No.2 INPUT.	3	max.	watts
PLATE DISSIPATION [†]	15	max.	watts
PEAK HEATER-CATHODE VOLTAGE:			
Heater negative with respect to cathode.	200	max.	volts
Heater positive with respect to cathode.	200 [▲]	max.	volts
BULB TEMPERATURE (At hottest point on bulb surface).	225	max.	°C

Maximum Circuit Values:

Grid-No.1-Circuit Resistance:

For grid-resistor-bias operation[†]. 0.47 max. megohm

[□] Without external shield.

* These values can be measured by a method involving a recurrent wave form such that the maximum ratings of the tube will not be exceeded.

[□] As described in "Standards of Good Engineering Practice Concerning Television Broadcast Stations", Federal Communications Commission.

[⊕] This rating is applicable when the duration of the voltage pulse does not exceed 15 per cent of one horizontal scanning cycle. In a 525-line, 30-frame system, 15 per cent of one horizontal scanning cycle is 10 microseconds.

[■] Under no circumstances should this absolute value be exceeded.

[†] It is essential that the plate dissipation be limited in the event of loss of grid-No.1 signal. For this purpose, some protective means such as a cathode resistor of suitable value should be employed.

[▲] The dc component must not exceed 100 volts.



25DN6

BEAM POWER TUBE

25DN6

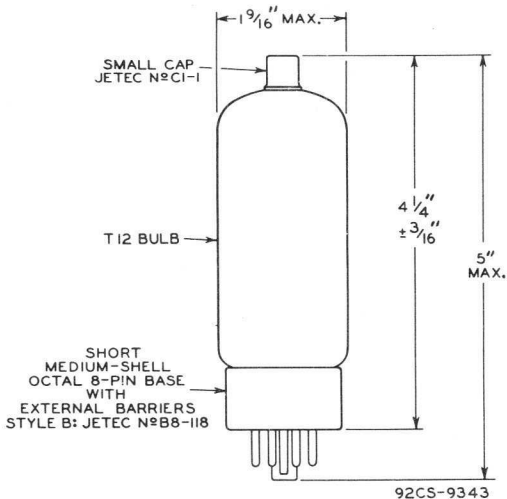





25EH5

25EH5 POWER PENTODE

7-PIN MINIATURE TYPE

The 25EH5 is the same as the 6EH5 except for the following items:

Heater, for Unipotential Cathode:

Voltage.	25	ac or dc volts
Current.	0.3	amp

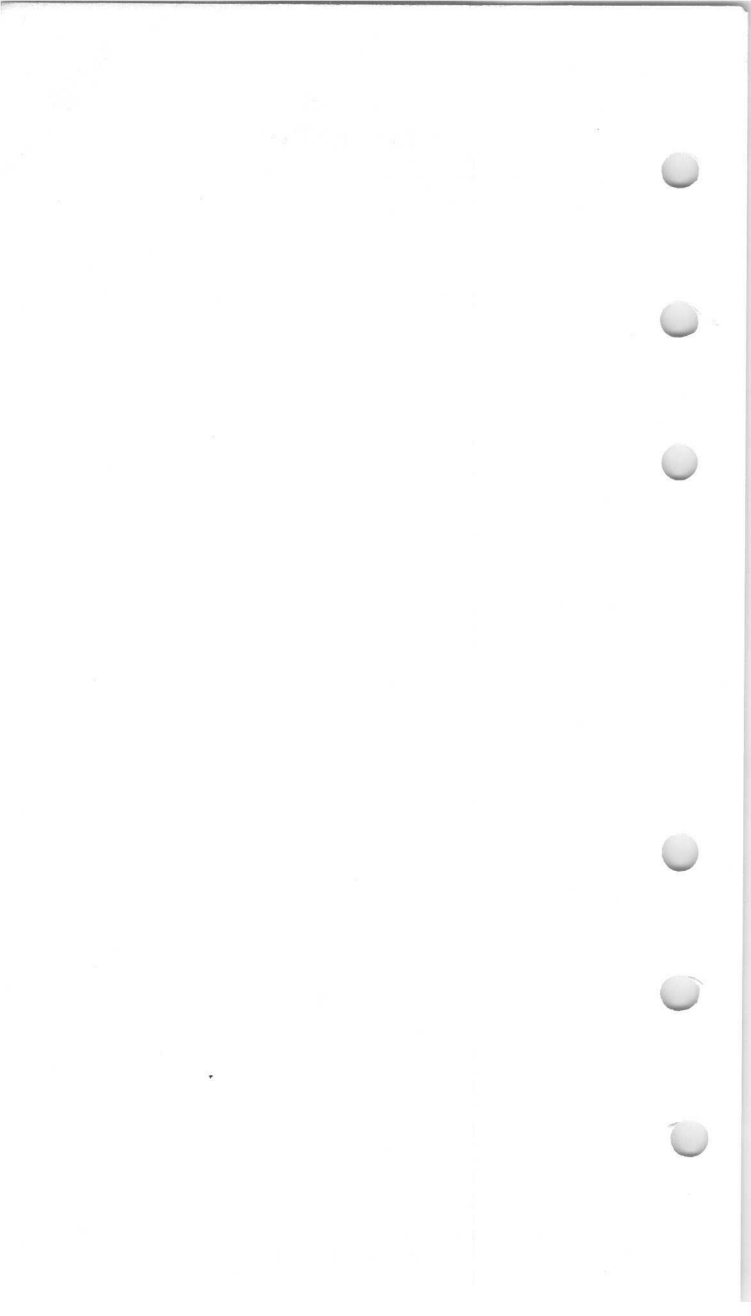

Beam Power Tube

7-PIN MINIATURE TYPE

With Heater Having Controlled Warm-Up Time

GENERAL DATA

Electrical:

Heater Characteristics and Ratings (*Design-Maximum Values*):

Current	0.150 ± 0.010	amp
Voltage (AC or DC) at heater amperes = 0.150	25.0	volts
Warm-up time (Average)	17	sec
Peak heater-cathode voltage:		
Heater negative with respect to cathode	200	max. volts
Heater positive with respect to cathode	200 ^a	max. volts

Direct Interelectrode Capacitances
(Approx.):^b

Grid No.1 to plate	0.44	pf
Grid No.1 to cathode & grid No.3, grid No.2, and heater	12.0	pf
Plate to cathode & grid No.3, grid No.2, and heater	8.0	pf

Characteristics, Class A₁ Amplifier:

Plate Voltage	110	volts
Grid-No.2 Voltage	110	volts
Grid-No.1 Voltage	-7.5	volts
Plate Resistance (Approx.)	13000	ohms
Transconductance	6400	μmhos
Plate Current	43	ma
Grid-No.2 Current	3.8	ma

Mechanical:

Operating Position	Any
Type of Cathode	Coated Unipotential
Maximum Overall Length	2-5/8"
Maximum Seated Length	2-3/8"
Length, Base Seat to Bulb Top (Excluding tip)	2" ± 3/32"
Diameter	0.650" to 0.750"
Bulb	T5-1/2
Base	Small-Button Miniature 7-Pin (JEDEC No.E7-1)
Basing Designation for BOTTOM VIEW	7CV

Pin 1-Cathode,
 Grid No.3
Pin 2-Grid No.1
Pin 3-Heater

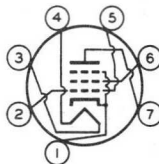

Pin 4-Heater
Pin 5-Grid No.1
Pin 6-Grid No.2
Pin 7-Plate



25F5A

AF POWER AMPLIFIER — Class A₁

Maximum Ratings, Design-Maximum Values:

PLATE VOLTAGE	150 max.	volts
GRID-No.2 (SCREEN-GRID) VOLTAGE	130 max.	volts
GRID-No.1 (CONTROL-GRID) VOLTAGE:		
Positive-bias value	0 max.	volts
GRID-No.2 INPUT	1.1 max.	watts
PLATE DISSIPATION	5.5 max.	watts
BULB TEMPERATURE (At hottest point on bulb surface).	220 max.	°C

Typical Operation:

Plate Voltage	110	volts
Grid-No.2 Voltage	110	volts
Grid-No.1 Voltage	-7.5	volts
Peak AF Grid-No.1 Voltage	7.5	volts
Zero-Signal Plate Current	43	ma
Max.-Signal Plate Current	45	ma
Zero-Signal Grid-No.2 Current	3.8	ma
Max.-Signal Grid-No.2 Current	7.3	ma
Effective Load Resistance	2500	ohms
Total Harmonic Distortion	7	%
Maximum-Signal Power Output	1.5	watts

Maximum Circuit Values:

Grid-No.1-Circuit Resistance:		
For fixed-bias operation.	0.1 max.	megohm
For cathode-bias operation.	0.5 max.	megohm

PUSH-PULL AF POWER AMPLIFIER — Class A₁

Maximum Ratings, Design-Maximum Values:

PLATE VOLTAGE	150 max.	volts
GRID-No.2 (SCREEN-GRID) VOLTAGE	130 max.	volts
GRID-No.1 (CONTROL-GRID) VOLTAGE:		
Positive-bias value	0 max.	volts
GRID-No.2 INPUT	1.1 max.	watts
PLATE DISSIPATION	5.5 max.	watts
BULB TEMPERATURE (At hottest point on bulb surface).	220 max.	°C

Typical Operation:

Values are for two tubes

Plate Voltage	110	volts
Grid-No.2 Voltage	110	volts
Grid-No.1 Voltage	-8	volts
Peak AF Grid-No.1-to-Grid-No.1 Voltage.	14.4	volts
Zero-Signal Plate Current	82	ma
Max.-Signal Plate Current	88	ma
Zero-Signal Grid-No.2 Current	7.2	ma
Max.-Signal Grid-No.2 Current	12.5	ma
Effective Load Resistance (Plate-to-plate).	4500	ohms



25F5A

Total Harmonic Distortion	2.6	%
Maximum-Signal Power Output	2.9	watts

Maximum Circuit Values:

Grid-No.1-Circuit Resistance:

For fixed-bias operation.	0.1 max.	megohm
For cathode-bias operation.	0.5 max.	megohm

^a The dc component must not exceed 100 volts.

^b without external shield.



25F5A

AVERAGE CHARACTERISTICS

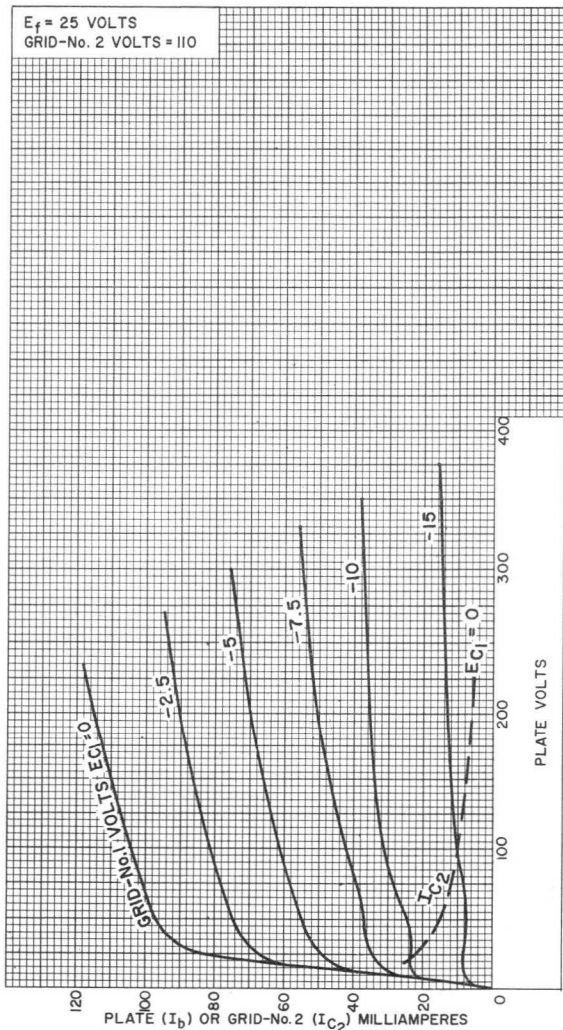

92 CM-11682



OPERATION CHARACTERISTICS

$E_f = 25$ VOLTS
 PLATE VOLTS = 110
 GRID-No. 2 VOLTS = 110
 GRID-No. 1 VOLTS = -7.5
 AF GRID-No.1 VOLTS
 (RMS) = 5.3

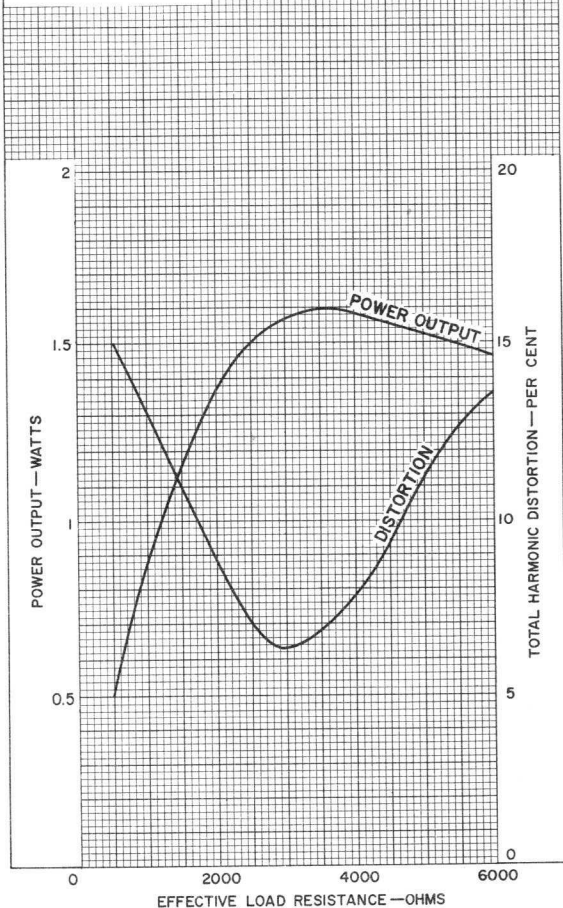

92CM-11680



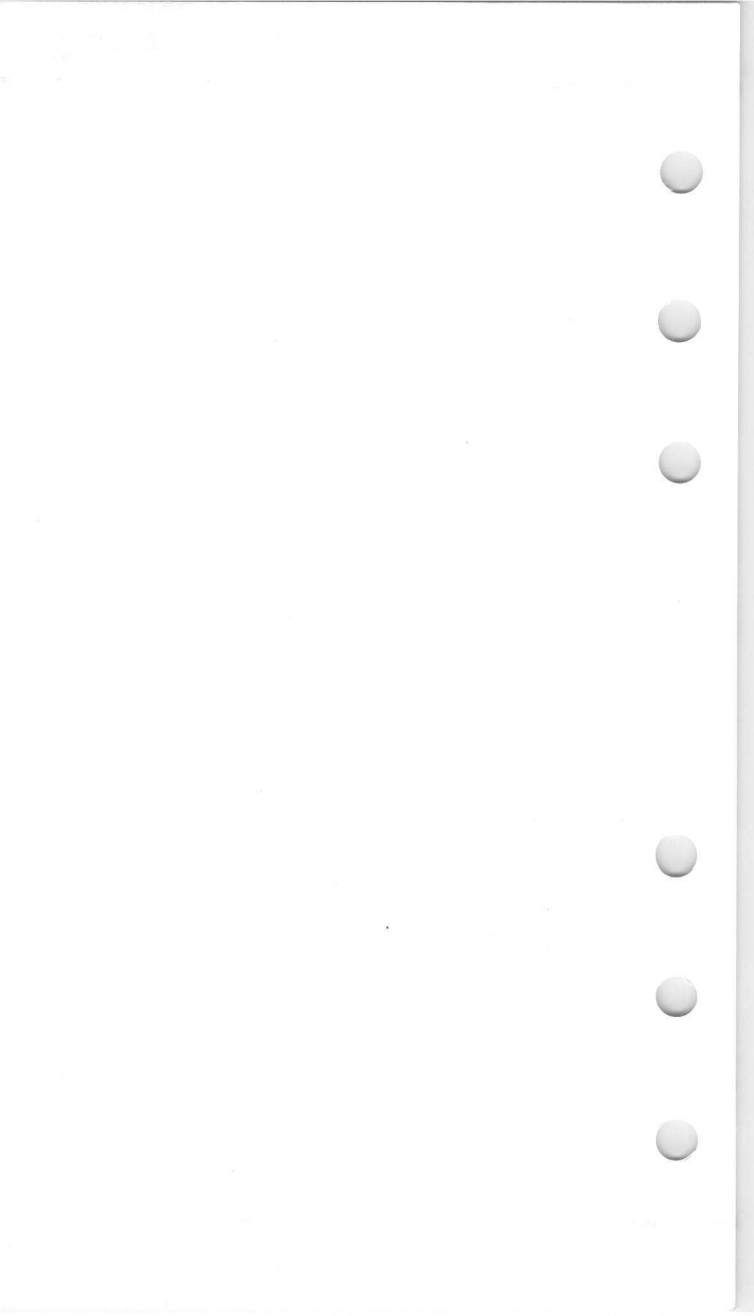

25JQ6

Beam Power Tube with an Integral Diode

The 25JQ6 is the same as the 6JQ6 except for:

Heater Characteristics and Ratings

Current.	0.300 ± 0.020	A
Voltage (AC or DC) at 0.300 A.	25.2	V
Warm-up time (Average)	11	s

31LQ6

Beam Power Tube

Novar Type

The 31LQ6 is the same as the 6LQ6 except for:

Heater Characteristics and Ratings

Current.	0.450 ± 0.020	A
Voltage (AC or DC) at 0.450 A	31.0	V
Warm-up time (Average)	11	s



Power Pentode

7-PIN MINIATURE TYPE

With Heater Having Controlled Warm-Up Time

GENERAL DATA

Electrical:

Heater Characteristics and Ratings (*Design-Maximum Values*):

Current	0.100 ± 0.006	amp
Voltage (AC or DC) at heater amperes = 0.100	32	volts
Warm-up time (Average).	20	sec
Peak heater-cathode voltage:		
Heater negative with respect to cathode.	200 max.	volts
Heater positive with respect to cathode.	200 ^a max.	volts

Direct Interelectrode Capacitances
(Approx.):^b

Grid No.1 to plate.	0.6	pf
Grid No.1 to cathode & grid No.3, grid No.2, and heater	12.0	pf
Plate to cathode & grid No.3, grid No.2, and heater	6.0	pf

Mechanical:

Operating Position.	Any
Type of Cathode	Coated Unipotential
Maximum Overall Length.	2-5/8"
Maximum Seated Length	2-3/8"
Length, Base Seat to Bulb Top (Excluding tip).	2" ± 3/32"
Diameter.	0.650" to 0.750"
Dimensional Outline.	See <i>General Section</i>
Bulb.	T5-1/2
Base.	Small-Button Miniature 7-Pin (JEDEC No.E7-1)
Basing Designation for BOTTOM VIEW.	7CV

Pin 1 - Cathode,
Grid No.3
Pin 2 - Grid No.1
Pin 3 - Heater

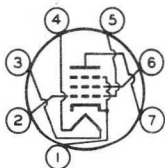

Pin 4 - Heater
Pin 5 - Grid No.1
Pin 6 - Grid No.2
Pin 7 - Plate

AMPLIFIER — Class A₁

Maximum Ratings, *Design-Maximum Values*:

PLATE VOLTAGE	150 max.	volts
GRID-No.2 (SCREEN-GRID) VOLTAGE	130 max.	volts
GRID-No.2 INPUT	1.2 max.	watts
PLATE DISSIPATION	5.4 max.	watts



32E5A

Typical Operation and Characteristics:

Plate Voltage	110	volts
Grid-No.2 Voltage	110	volts
Grid-No.1 Voltage	-7.5	volts
Peak AF Grid-No.1 Voltage	7.5	volts
Zero-Signal Plate Current	30	ma
Zero-Signal Grid-No.2 Current	2.8	ma
Plate Resistance (Approx.)	21500	ohms
Transconductance	5500	μ mhos
Load Resistance	2800	ohms
Total Harmonic Distortion	10	%
Max.-Signal Power Output	1.2	watts

Maximum Circuit Values:

Grid-No.1-Circuit Resistance:		
For fixed-bias operation	0.1 max.	megohm
For cathode-bias operation	0.5 max.	megohm

^a The dc component must not exceed 100 volts.

^b Without external shield.



33JR6

Beam Power Tube

Novar Type

The 33JR6 is the same as the 6JR6 except for:

Heater Characteristics and Ratings

Current	0.300 ± 0.020	A
Voltage (ac or dc) at 0.300 A	33.0	V
Warm-up time (Average)	11	s

34CM3

Half-Wave Vacuum Rectifier

Novar Type

The 34CM3 is the same as the 6CM3 except for:

Heater Characteristics and Ratings

Current	0.450 ± 0.030	A
Voltage (ac or dc) at 0.450 A	33.5	V
Warm-up time (Average)	11	s



34GD5A

Beam Power Tube

7-PIN MINIATURE TYPE

With Heater Having Controlled Warm-Up Time

GENERAL DATA

Electrical:

Heater, for Unipotential Cathode:

Voltage (AC or DC)	34	volts
Current	0.1 ± 6%	amp
Warm-up time (Average)	20	sec

Direct Interelectrode Capacitances

(Approx.):^a

Grid No.1 to plate	0.6	μf
Grid No.1 to cathode & grid No.3, grid No.2, and heater	12	μf
Plate to cathode & grid No.3, grid No.2, and heater	6	μf

Mechanical:

Operating Position	Any
Maximum Overall Length	2-5/8"
Maximum Seated Length	2-3/8"
Length, Base Seat to Bulb Top (Excluding tip)	2" ± 3/32"
Diameter	0.650" to 0.750"
Dimensional Outline	See <i>General Section</i>
Bulb	T5-1/2
Base	Small-Button Miniature 7-Pin (JEDEC No.E7-1)
Basing Designation for BOTTOM VIEW	7CV

Pin 1-Cathode,
Grid No.3
Pin 2-Grid No.1
Pin 3-Heater

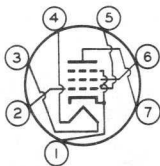

Pin 4-Heater
Pin 5-Grid No.1
Pin 6-Grid No.2
Pin 7-Plate

AMPLIFIER — Class A₁

Maximum Ratings, *Design-Maximum Values:*

PLATE VOLTAGE	150	max.	volts
GRID-No.2 (SCREEN-GRID) VOLTAGE	130	max.	volts
GRID-No.1 (CONTROL-GRID) VOLTAGE:			
Negative-bias value	50	max.	volts
Positive-bias value	0	max.	volts
GRID-No.2 INPUT	1.1	max.	watts
PLATE DISSIPATION	5	max.	watts
PEAK HEATER-CATHODE VOLTAGE:			
Heater negative with respect to cathode	200	max.	volts
Heater positive with respect to cathode	200 ^b	max.	volts
BULB TEMPERATURE (At hottest point on bulb surface)	250	max.	°C



34GD5A

Typical Operation and Characteristics:

Plate Voltage	110	volts
Grid-No.2 Voltage	110	volts
Grid-No.1 Voltage	-7.5	volts
Peak AF Grid-No.1 Voltage	7.5	volts
Zero-Signal Plate Current	35	ma
Zero-Signal Grid-No.2 Current	3	ma
Plate Resistance (Approx.)	13000	ohms
Transconductance	5700	μ mhos
Load Resistance	2500	ohms
Total Harmonic Distortion	10	%
Max.-Signal Power Output	1.4	watts

Maximum Circuit Values:

Grid-No.1-Circuit Resistance:

For fixed-bias operation	0.1 max.	megohm
For cathode-bias operation	0.5 max.	megohm

^a Without external shield.

^b The dc component must not exceed 100 volts.

OPERATION CHARACTERISTICS

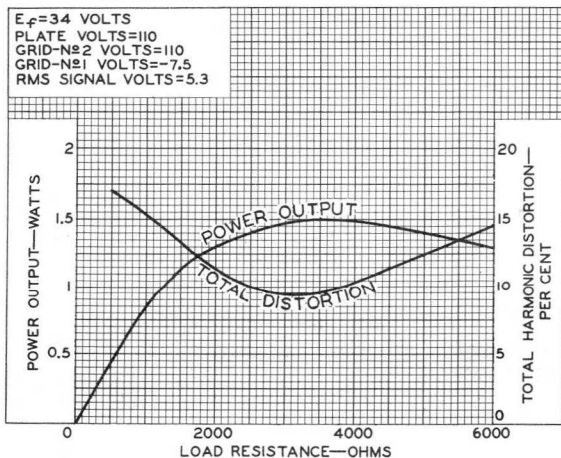

92CS-10780



AVERAGE CHARACTERISTICS

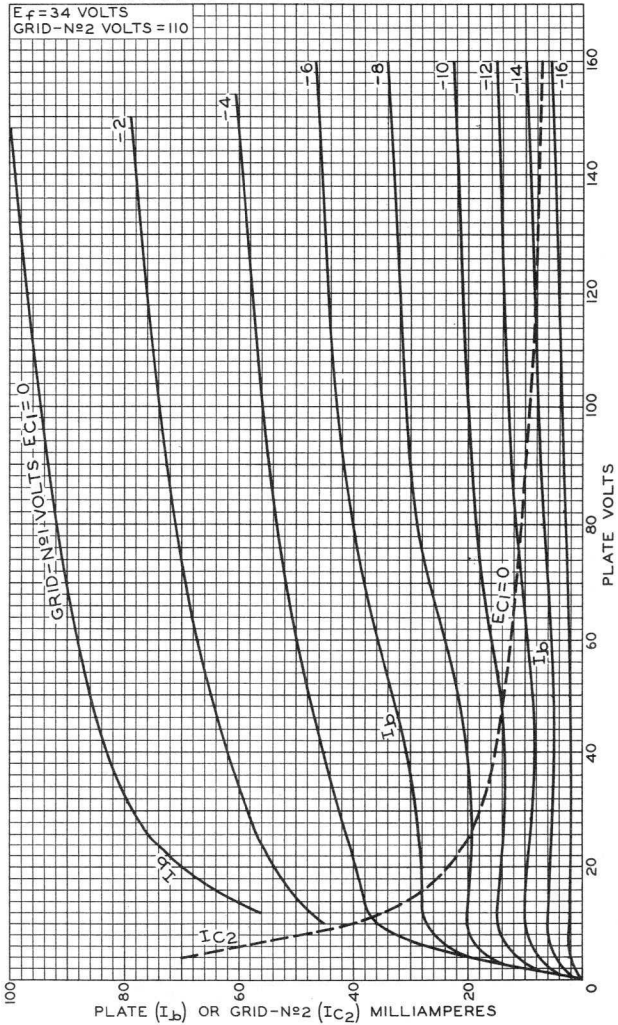

92CM-10779



1968



Beam Power Tube

7-PIN MINIATURE TYPE

GENERAL DATA

Electrical:

Heater, for Unipotential Cathode:

Voltage (AC or DC) $35 \pm 10\%$ volts ←
 Current at 35 volts 0.15 amp

Direct Interelectrode Capacitances (Approx.):^a

Grid No.1 to plate 0.6 μf
 Grid No.1 to cathode & grid No.3,
 grid No.2, and heater 12 μf
 Plate to cathode & grid No.3,
 grid No.2, and heater 9 μf

Mechanical:

Operating Position Any
 Maximum Overall Length 2-5/8"
 Maximum Seated Length 2-3/8"
 Length, Base Seat to Bulb Top (Excluding tip) $2" \pm 3/32"$
 Diameter 0.650" to 0.750"
 Dimensional Outline See *General Section*
 Bulb T5-1/2
 Base Small-Button Miniature 7-Pin (JEDEC No.E7-1)
 Basing Designation for BOTTOM VIEW 7CV

Pin 1 - Cathode,
 Grid No.3
 Pin 2 - Grid No.1
 Pin 3 - Heater

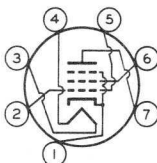

Pin 4 - Heater
 Pin 5 - Grid No.1
 Pin 6 - Grid No.2
 Pin 7 - Plate

AF POWER AMPLIFIER — Class A₁

Maximum Ratings, Design-Maximum Values:

PLATE VOLTAGE 150 max. volts ←
 GRID-No.2 (SCREEN-GRID) VOLTAGE 130 max. volts
 GRID-No.1 (CONTROL-GRID) VOLTAGE:
 Positive-bias value 0 max. volts
 GRID-No.2 INPUT 1.1 max. watts
 PLATE DISSIPATION 5.2 max. watts
 PEAK HEATER-CATHODE VOLTAGE:
 Heater negative with
 respect to cathode 200 max. volts
 Heater positive with
 respect to cathode 200^b max. volts
 BULB TEMPERATURE (At hottest point
 on bulb surface) 250 max. °C

← Indicates a change.



35C5

Typical Operation and Characteristics:

Plate Voltage	110	volts
Grid-No.2 Voltage	110	volts
Grid-No.1 (Control-Grid) Voltage	-7.5	volts
Peak AF Grid-No.1 Voltage	7.5	volts
Zero-Signal Plate Current	40	ma
Max.-Signal Plate Current	41	ma
Zero-Signal Grid-No.2 Current	3	ma
Max.-Signal Grid-No.2 Current	7	ma
Plate Resistance (Approx.)	13000	ohms
Transconductance	5800	μ hos
Load Resistance	2500	ohms
Total Harmonic Distortion	10	%
Max.-Signal Power Output	1.5	watts

Maximum Circuit Values:

Grid-No.1-Circuit Resistance:

For fixed-bias operation	0.1 max.	megohm
For cathode-bias operation	0.5 max.	megohm

^a Without external shield.

^b The dc component must not exceed 100 volts.



AVERAGE CHARACTERISTICS

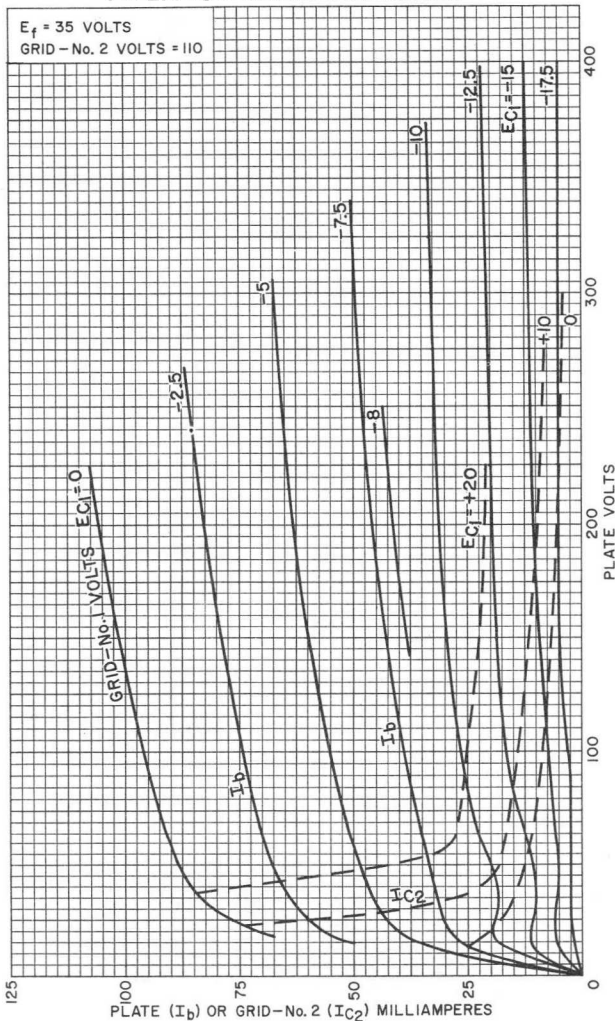

92CM-6312RI



35C5

OPERATION CHARACTERISTICS

$E_f = 35$ VOLTS
PLATE VOLTS = 110
GRID-NO. 2 VOLTS = 110
GRID-NO. 1 VOLTS = -7.5
RMS SIGNAL VOLTS = 5.3

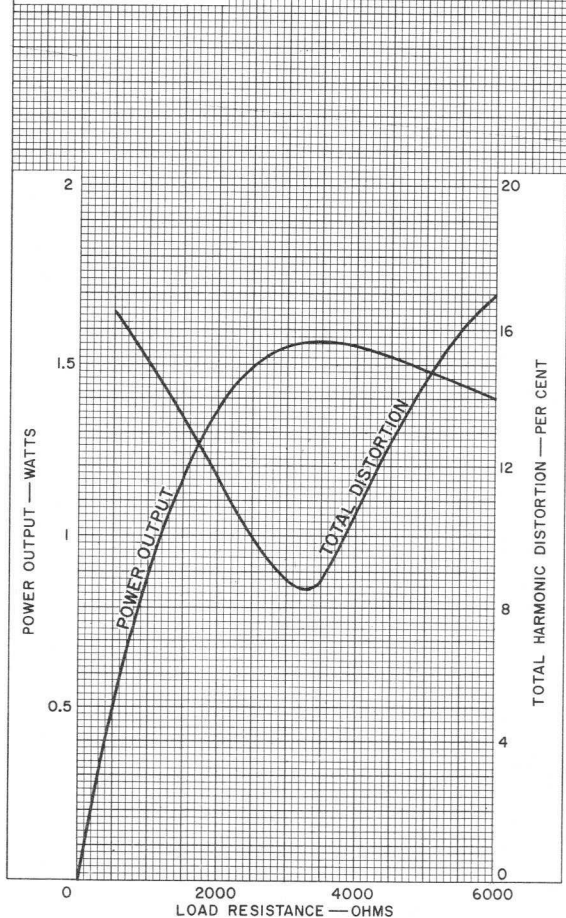

92CM-6794

RADIO CORPORATION OF AMERICA
Electron Tube Division

Harrison, N. J.



Power Pentode

7-PIN MINIATURE TYPE

GENERAL DATA

Electrical:

Heater, for Unipotential Cathode:

Voltage (AC or DC)	35 ± 10%	volts
Current at 35 volts	0.15	amp

Direct Interelectrode Capacitances

(Approx.):[▲]

Grid No.1 to plate	0.65	μf
Grid No.1 to cathode & grid No.3, grid No.2, and heater	17	μf
Plate to cathode & grid No.3, grid No.2, and heater	9	μf

Mechanical:

Operating Position	Any
Maximum Overall Length	2-5/8"
Maximum Seated Length	2-3/8"
Length, Base Seat to Bulb Top (Excluding tip)	2" ± 3/32"
Diameter	0.650" to 0.750"
Dimensional Outline	See <i>General Section</i>
Bulb	T5-1/2
Base	Small-Button Miniature 7-Pin (JEDEC No.E7-1)
Basing Designation for BOTTOM VIEW	7CV

Pin 1 - Cathode,
Grid No.3
Pin 2 - Grid No.1
Pin 3 - Heater

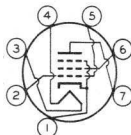

Pin 4 - Heater
Pin 5 - Grid No.1
Pin 6 - Grid No.2
Pin 7 - Plate

AF POWER AMPLIFIER — Class A₁

Maximum Ratings, Design-Maximum Values:

PLATE VOLTAGE	150	max.	volts
GRID-No.2 (SCREEN-GRID) VOLTAGE	130	max.	volts
GRID-No.1 (CONTROL-GRID) VOLTAGE:			
Positive-bias value	0	max.	volts
GRID-No.2 INPUT	1.75	max.	watts
PLATE DISSIPATION	5	max.	watts
PEAK HEATER-CATHODE VOLTAGE:			
Heater negative with respect to cathode	200	max.	volts
Heater positive with respect to cathode	200	max.	volts
BULB TEMPERATURE (At hottest point on bulb surface)	225	max.	°C



35EH5

Typical Operation and Characteristics:

Plate Supply Voltage.	110	volts
Grid-No.2 Supply Voltage.	115	volts
Cathode Resistor.	62	ohms
Peak AF Grid-No.1 Voltage	3	volts
Zero-Signal Plate Current	32	ma
Max.-Signal Plate Current	32	ma
Zero-Signal Grid-No.2 Current	7.2	ma
Max.-Signal Grid-No.2 Current	12	ma
Plate Resistance (Approx.).	14000	ohms
Transconductance.	12000	μ mhos
Load Resistance	3000	ohms
Total Harmonic Distortion	8	%
Max.-Signal Power Output.	1.2	watts

Maximum Circuit Values:

Grid-No.1-Circuit Resistance:

For fixed-bias operation.	0.1 max.	megohm
For cathode-bias operation.	0.5 max.	megohm

▲ Without external shield.

● The dc component must not exceed 100 volts.



AVERAGE CHARACTERISTICS

$E_f = 35$ VOLTS
 GRID-No 2 VOLTS = 115

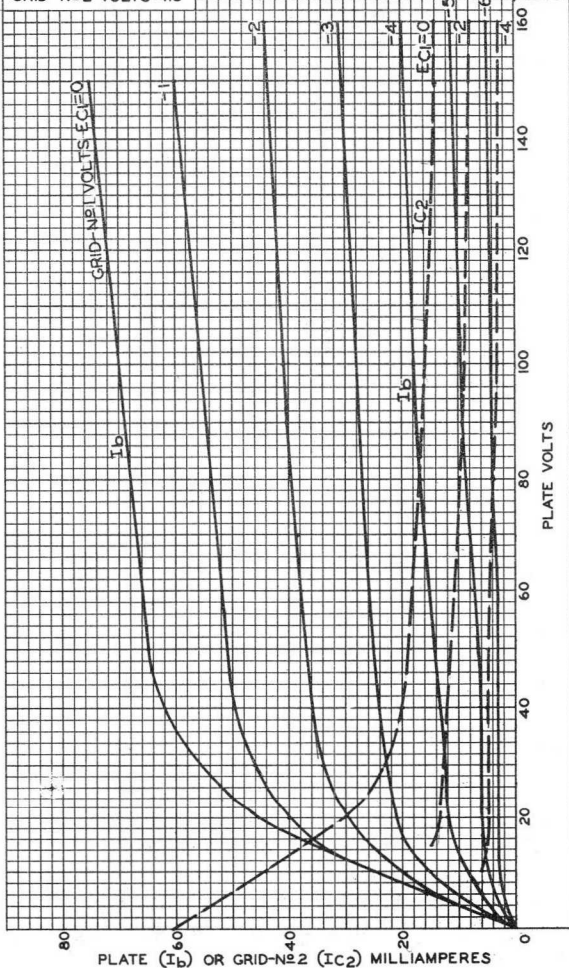

92CM-10551



35EH5

OPERATION CHARACTERISTICS

$E_f = 35$ VOLTS
PLATE SUPPLY VOLTS = 110
GRID-№2 SUPPLY VOLTS = 115
CATHODE RESISTOR (OHMS) = 62
CATHODE-BYPASS CAPACITOR (μf) = 100
SIGNAL VOLTS (RMS) = 2.1

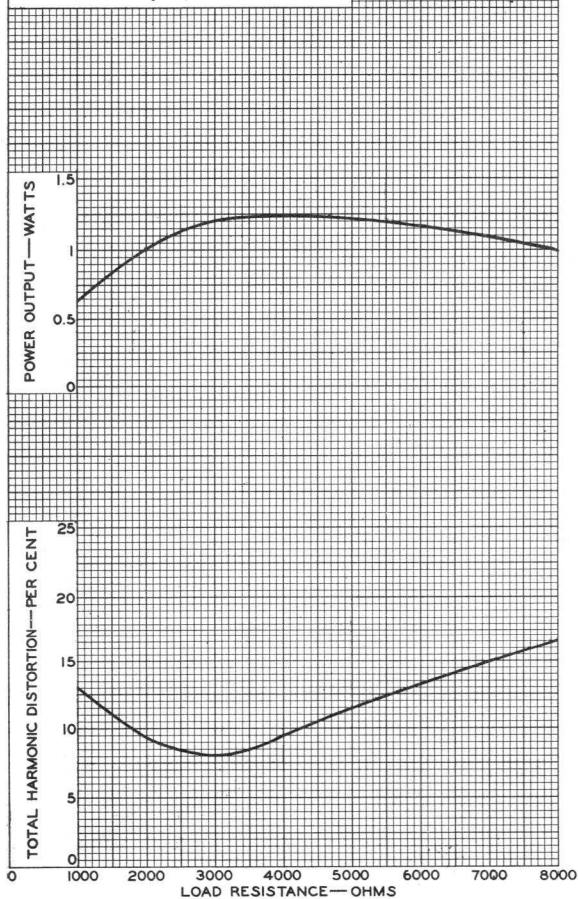

92CM-10547





35L6-GT

35L6-GT

BEAM POWER AMPLIFIER

GENERAL DATA

Electrical:

Heater, for Unipotential Cathode:

Voltage.	35	ac or dc volts
Current.	0.15	amp

Direct Interelectrode Capacitances (Approx.):⁰

Grid No.1 to Plate	0.8	$\mu\mu\text{f}$
Input.	13	$\mu\mu\text{f}$
Output	9.5	$\mu\mu\text{f}$

⁰ With no external shield.

Mechanical:

Mounting Position.	Any
Maximum Overall Length	3-5/16"
Maximum Seated Length.	2-3/4"
Maximum Diameter	1-5/16"
Bulb	T-9
Base	Intermediate-Shell Octal 7-Pin
Basing Designation for BOTTOM VIEW	G-7AC

Pin 1 - No
Connection
Pin 2 - Heater
Pin 3 - Plate
Pin 4 - Grid No.2

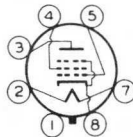

Pin 5 - Grid No.1
Pin 7 - Heater
Pin 8 - Cathode,
Grid No.3

AF POWER AMPLIFIER - Class A₁

Maximum Ratings, Design-Center Values:

PLATE VOLTAGE.	200 max.	volts
GRID-No.2 (SCREEN) VOLTAGE	117 max.	volts
PLATE DISSIPATION.	8.5 max.	watts
GRID-No.2 DISSIPATION.	1.0 max.	watt
PEAK HEATER-CATHODE VOLTAGE:		
Heater negative with respect to cathode	90 max.	volts
Heater positive with respect to cathode	90 max.	volts

Typical Operation and Characteristics:

Plate Voltage.	110	200	volts
Grid-No.2 Voltage	110	110	volts
Grid-No.1 (Control-Grid) Voltage	-7.5	-8	volts
Peak AF Grid-No.1 Voltage.	7.5	8	volts
Zero-Signal Plate Current.	40	41	ma.
Max.-Signal Plate Current.	41	44	ma.
Zero-Signal Grid-No.2 Current.	3	2	ma.
Max.-Signal Grid-No.2 Current.	7	7	ma.
Plate Resistance (Approx.)	14000	40000	ohms
Transconductance	5800	5900	μmhos
Load Resistance.	2500	4500	ohms
Total Harmonic Distortion.	10	10	%
Max.-Sig. Power Output	1.5	3.3	watts

35L6-GT



35L6-GT BEAM POWER AMPLIFIER

Maximum Circuit Values (for maximum rated conditions):

Grid-No. 1-Circuit Resistance:

For fixed bias	0.1 . . megohm
For cathode bias	0.5 . . megohm

Curves shown under Type 35B5 are also applicable to the 35L6-GT.



35L6-GT

35L6-GT

AVERAGE PLATE CHARACTERISTICS PENTODE CONNECTION

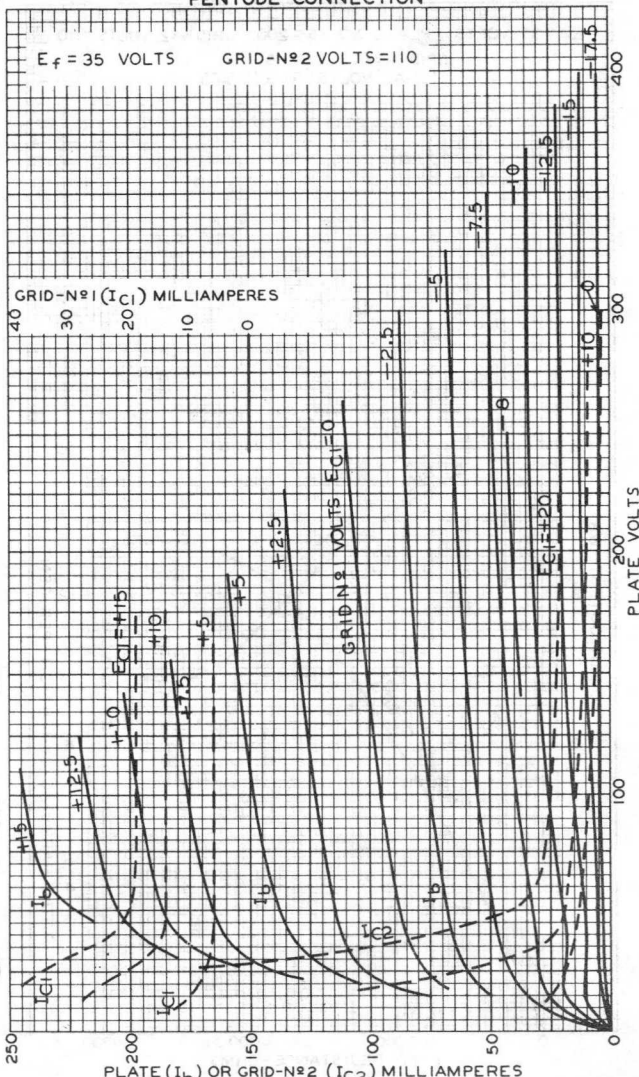

AUG. 11, 1941

TUBE DEPARTMENT

92CM-6309

RADIO CORPORATION OF AMERICA, HARRISON, NEW JERSEY

35L6-GT



35L6-GT

OPERATION CHARACTERISTICS

$E_f = 35$ VOLTS PLATE VOLTS = 200 GRID N^o2 VOLTS = 110
GRID N^o1 VOLTS = -8
SIGNAL VOLTS (RMS) = 5.65

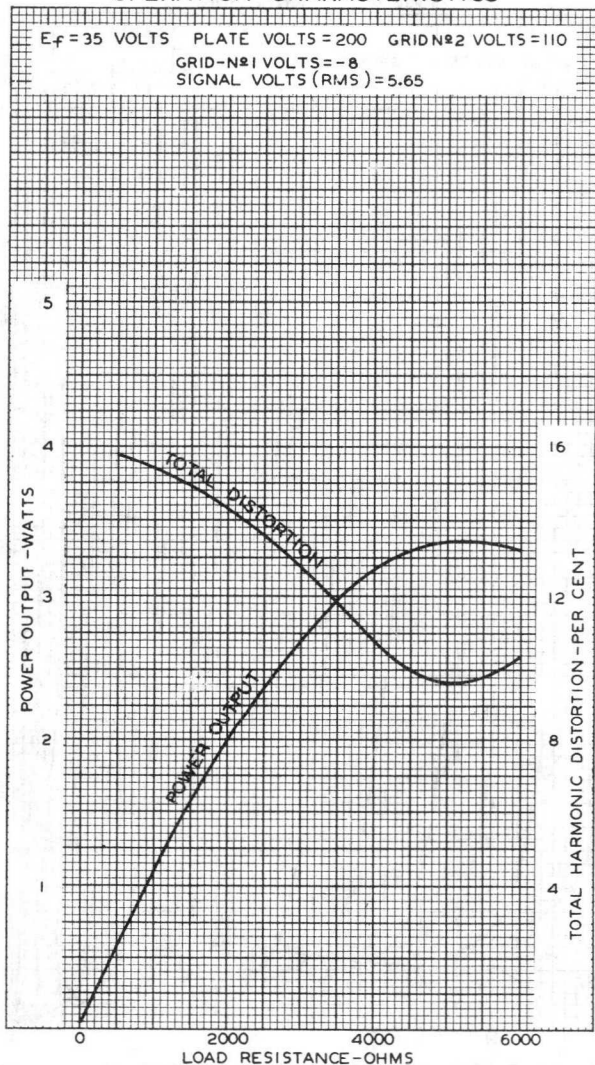

AUG. 21, 1941

TUBE DEPARTMENT
RADIO CORPORATION OF AMERICA, HARRISON, NEW JERSEY

92CM-6315



35L6-GT

35L6-GT

AVERAGE PLATE CHARACTERISTICS

TRIODE CONNECTION

$E_f = 35$ VOLTS
GRID-N^o2 CONNECTED TO PLATE

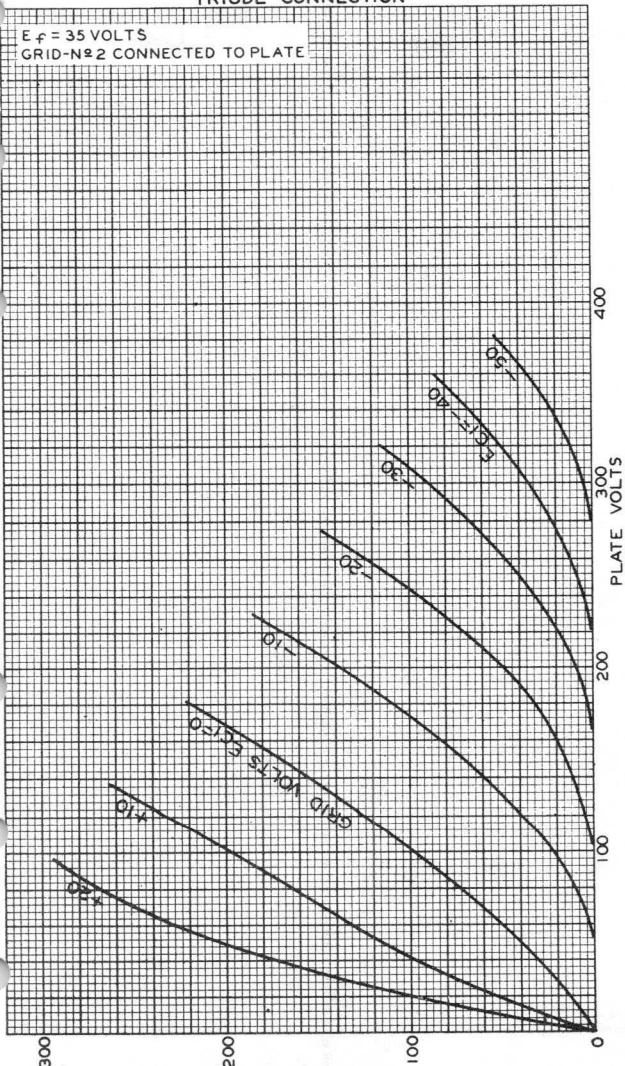

AUG. 6, 1941

PLATE MILLIAMPERES
TUBE DEPARTMENT
RADIO CORPORATION OF AMERICA, HARRISON, NEW JERSEY

92CM-6307RI

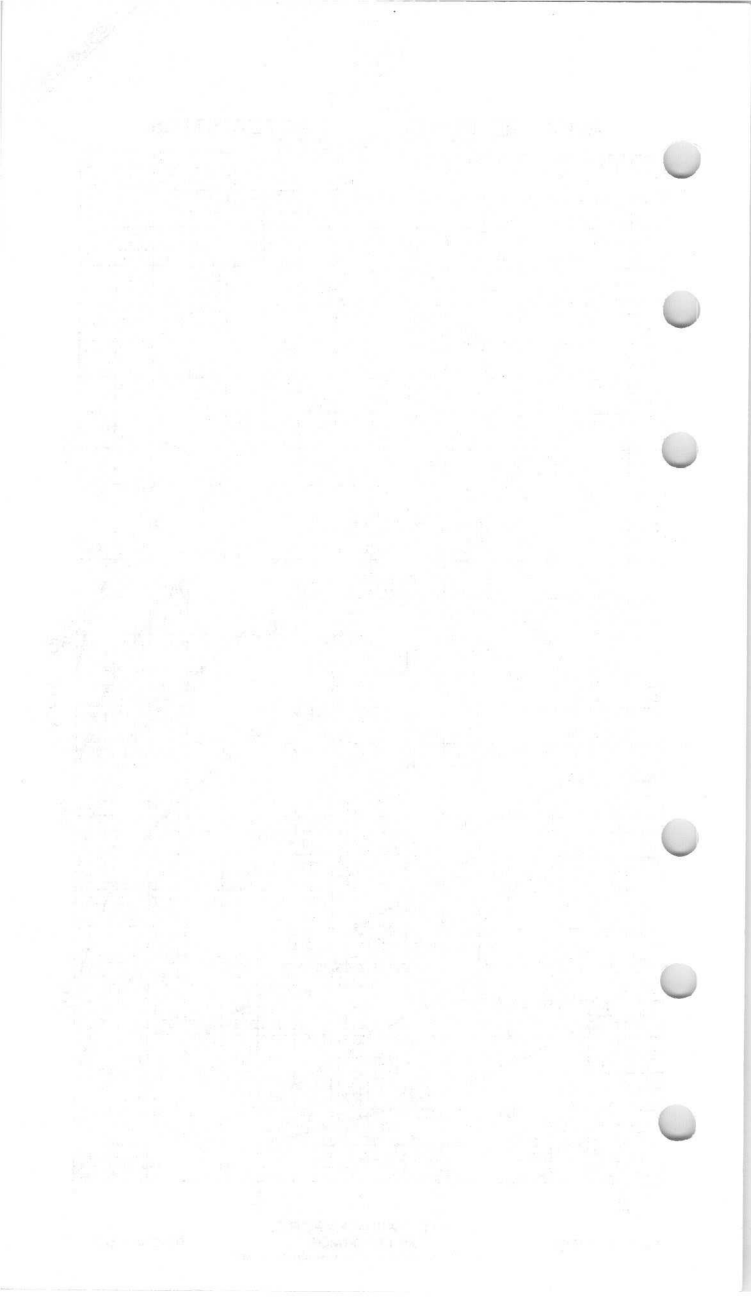



35W4

35W4

HALF-WAVE VACUUM RECTIFIER

MINIATURE TYPE

GENERAL DATA

Electrical:	Without Panel Lamp	With No. 40 or No. 47 Panel Lamp	
Heater, for Unipotential Cathode:			
Voltage (AC or DC):			
Entire Heater (pins 3 & 4)	35	32	volts
Panel-Lamp Section (pins 4 & 6)	7.5	5.5	volts
Current {	between pins 3 & 4	0.15	amp
	between pins 3 & 6	-	0.15 amp

Mechanical:

Mounting Position	Any
Maximum Overall Length	2-5/8"
Maximum Seated Length	2-3/8"
Length from Base Seat to Bulb Top (Excluding tip)	2" ± 3/32"
Maximum Diameter	3/4"
Bulb	T-5-1/2

Base Small-Button Miniature 7-Pin 5BQ

- Basing Designation for BOTTOM VIEW 5BQ
- Pin 1 - No Connection
 - Pin 2 - No Connection
 - Pin 3 - Heater
 - Pin 4 - Heater
 - Pin 5 - Plate
 - Pin 6 - Heater Tap
 - Pin 7 - Cathode
- Panel-Lamp Heater Section is between pins 4 & 6

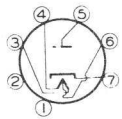

HALF-WAVE RECTIFIER

Maximum Ratings, Design-Center Values:

PEAK INVERSE PLATE VOLTAGE	330 max.	volts
PEAK PLATE CURRENT	600 max.	ma
DC OUTPUT CURRENT:		
With Panel Lamp & { No Shunting Resistor	60 max.	ma
{ Shunting Resistor	90 max.	ma
Without Panel Lamp	100 max.	ma
PANEL-LAMP-SECTION VOLTAGE (RMS):		
When panel lamp fails	15 max.	volts
PEAK HEATER-CATHODE VOLTAGE:		
Heater negative with respect to cathode	330 max.	volts
Heater positive with respect to cathode	330 max.	volts

Typical Operation with No.40 or No.47 Panel Lamp in Accompanying Half-Wave Circuit with Capacitor-Input Filter:

AC Plate-Supply Volt. (RMS)	117	117	117	117	volts
Filter-Input Capacitor	40	40	40	40	µf
Min. Total Effective Plate-Supply Impedance	15	15	15	15	ohms
Panel-Lamp Shunting Res.	-	300	150	100	ohms
DC Output Current	60	70	80	90	ma

← Indicates a change.

35W4



35W4

HALF-WAVE VACUUM RECTIFIER

Typical Operation without Panel Lamp in Conventional Half-Wave Circuit with Capacitor-Input Filter:

AC Plate-Supply Voltage (RMS)	117	volts
Filter-Input Capacitor	40	μ f
Min. Total Effective Plate-Supply Imped.	15	ohms
DC Output Current	100	ma
DC Output Voltage at Input to Filter (Approx.):		
→ At half-load current (50 ma.)	135	volts
At full-load current (100 ma.)	120	volts
Voltage Regulation (Approx.):		
→ Half-load to full-load current	15	volts

Maximum Circuit Values:

Panel-Lamp Shunting Resistor:*

For dc output current of	{	70 ma.	800 max. ohms
		80 ma.	400 max. ohms
		90 ma.	250 max. ohms

*Required when dc output current is greater than 60 ma.

HALF-WAVE CIRCUIT with No.40 or No.47 Panel Lamp

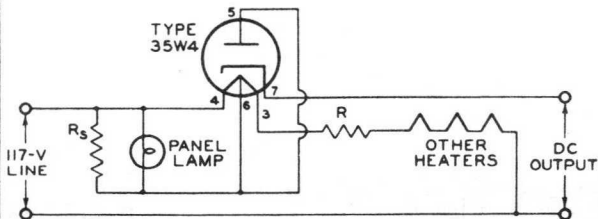

DROP ACROSS R AND ALL HEATERS (WITH PANEL LAMP) SHOULD EQUAL 117 VOLTS AT 0.15 AMPERE. R_s = SHUNTING RESISTOR REQUIRED WHEN DC OUTPUT CURRENT EXCEEDS 60 MILLIAMPERES

92C5-6626

Devices and arrangements shown or described herein may use patents of RCA or others. Information contained herein is furnished without responsibility by RCA for its use and without prejudice to RCA's patent rights.

→ Indicates a change.



35W4

35W4 OPERATION CHARACTERISTICS HALF-WAVE RECTIFIER

$E_f = 35$ VOLTS BETWEEN PINS NO 3 & NO 4
(NO TAP CONNECTION)

PLATE VOLTS = 117 RMS

TOTAL EFFECTIVE PLATE-SUPPLY
IMPEDANCE = 15 OHMS

C = CAPACITOR INPUT TO FILTER

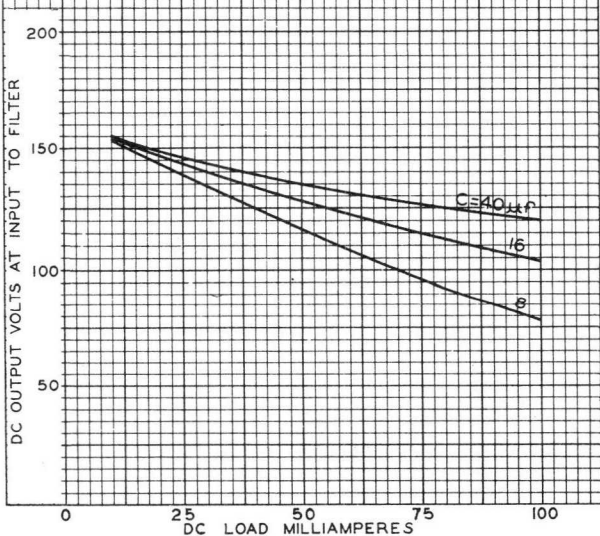

35W4



35W4

AVERAGE PLATE CHARACTERISTIC

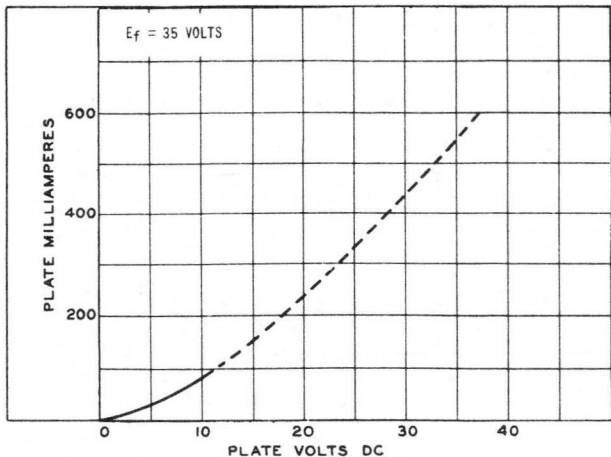

92CM-6305TV

Half-Wave Vacuum Rectifier

7-PIN MINIATURE TYPE

With Heater Having Controlled Warm-Up Time

GENERAL DATA

Electrical:

Heater^a, for Unipotential Cathode:

Voltage (AC or DC):

Entire heater (Pins 3 and 4)	36	volts
Tap-section (Pins 3 and 6)	32	volts

Current:

Tap-section (Pins 3 and 6)	0.1 ± 6%	amp
Warm-up time (Average)	20	sec

Mechanical:

Operating Position	Any
Maximum Overall Length	2-5/8"
Maximum Seated Length	2-3/8"
Length, Base Seat to Bulb Top (Excluding tip)	2" ± 3/32"
Diameter	0.650" to 0.750"
Dimensional Outline	See <i>General Section</i>
Bulb	T5-1/2
Base	Small-Button Miniature 7-Pin (JEDEC No. E7-1)
Basing Designation for BOTTOM VIEW	5BQ

- Pin 1—No Connection
- Pin 2—No Connection
- Pin 3—Heater

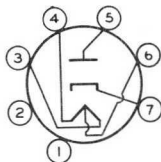

- Pin 4—Heater
- Pin 5—Plate
- Pin 6—Heater Tap
- Pin 7—Cathode

HALF-WAVE RECTIFIER

Maximum Ratings, *Design-Maximum Values:*

PEAK INVERSE PLATE VOLTAGE	365	max.	volts
PEAK PLATE CURRENT	530	max.	ma
DC OUTPUT CURRENT	82	max.	ma
PEAK HEATER-CATHODE VOLTAGE:			
Heater negative with respect to cathode	350 ^b	max.	volts
Heater positive with respect to cathode	200 ^c	max.	volts

Typical Operation:

In accompanying typical half-wave circuit with capacitor-input filter

AC Plate Supply Voltage (RMS)	120	volts
Filter-Input Capacitor	40	μf
Total Effective Plate Supply Resistance	a	
DC Output Current	75	ma
DC Output Voltage at Input to Filter (Approx.)	118	volts



36AM3B

Characteristics:

Tube-Voltage Drop for plate ma. = 150 16 volts

- a The *heater* of the 36AM3B is designed so that the heater section between pins 4 and 6 is used as a limiting resistance in the rectifier plate circuit (See accompanying *Typical Half-Wave Circuit*). This type is *not* designed for use with a panel lamp where the heater section between pins 4 and 6 is used as a panel-lamp shunt.
- b The DC component must not exceed 350 volts.
- c The DC component must not exceed 100 volts.

TYPICAL HALF-WAVE CIRCUIT

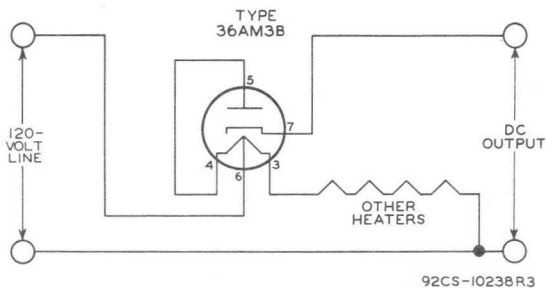

36MC6

Beam Power Tube

The 36MC6 is the same as the 6MC6 except for:

Heater Characteristics and Ratings

Current	0.450 + 0.030	A
Voltage (AC or DC) at 0.450 A	36.0	V





50B5

50B5

BEAM POWER AMPLIFIER

MINIATURE TYPE

GENERAL DATA

Electrical:

Heater, for Unipotential Cathode:

Voltage. 50 ac or dc volts

Current. 0.15 amp.

Direct Interelectrode Capacitances (Approx.):⁰

Grid-No.1 to Plate 0.5 μf

Input. 13 μf

Output 6.5 μf

Mechanical:

Mounting Position. Any

Maximum Overall Length 2-5/8"

Maximum Seated Length. 2-3/8"

Length from Base Seat

to Bulb Top (excluding tip). 2" \pm 3/32"

Maximum Diameter 3/4"

Bulb T-5-1/2

Base Miniature Button 7-Pin

Basing Designation for BOTTOM VIEW 7BZ

Pin 1-Grid No.1

Pin 2-Cathode,

Grid No.3

Pin 3-Heater

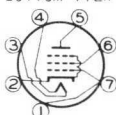

Pin 4-Heater

Pin 5-Plate

Pin 6-Grid No.2

Pin 7-Grid No.1

CLASS A₁ AMPLIFIER

Maximum Ratings, Design-Center Values:

PLATE VOLTAGE. 117 max. volts

GRID-No.2 (SCREEN) VOLTAGE 117 max. volts

PLATE DISSIPATION. 5.5 max. watts

GRID-No.2 DISSIPATION. 1.25 max. watts

PEAK HEATER-CATHODE VOLTAGE:

Heater negative with respect to cathode. 90 max. volts

Heater positive with respect to cathode. 90 max. volts

Typical Operation and Characteristics:

Plate Voltage. 110 . . volts

Grid-No.2 Voltage. 110 . . volts

Grid-No.1 Voltage. -7.5 . . volts

Peak A-F Grid-No.1 Voltage 7.5 . . volts

Zero-Signal Plate Current. 49 . . . ma.

Max.-Signal Plate Current. 50 . . . ma.

⁰With no external shield.

50B5



50B5

BEAM POWER AMPLIFIER

Zero-Signal Grid-No.2 Current (Approx.)	4	ma.
Max.-Signal Grid-No.2 Current (Approx.)	8.5	ma.
Plate Resistance (Approx.)	14000	ohms
Transconductance	7500	μmhos
Load Resistance.	2500	ohms
Total Harmonic Distortion.	9	%
Max.-Sig. Power Output	1.9	watts

Maximum Circuit Values (for maximum rated conditions):

Grid-No.1-Circuit Res.	{	fixed bias	0.1	megohm
		cathode bias	0.5	megohm



50B5

50B5

AVERAGE PLATE CHARACTERISTICS PENTODE CONNECTION

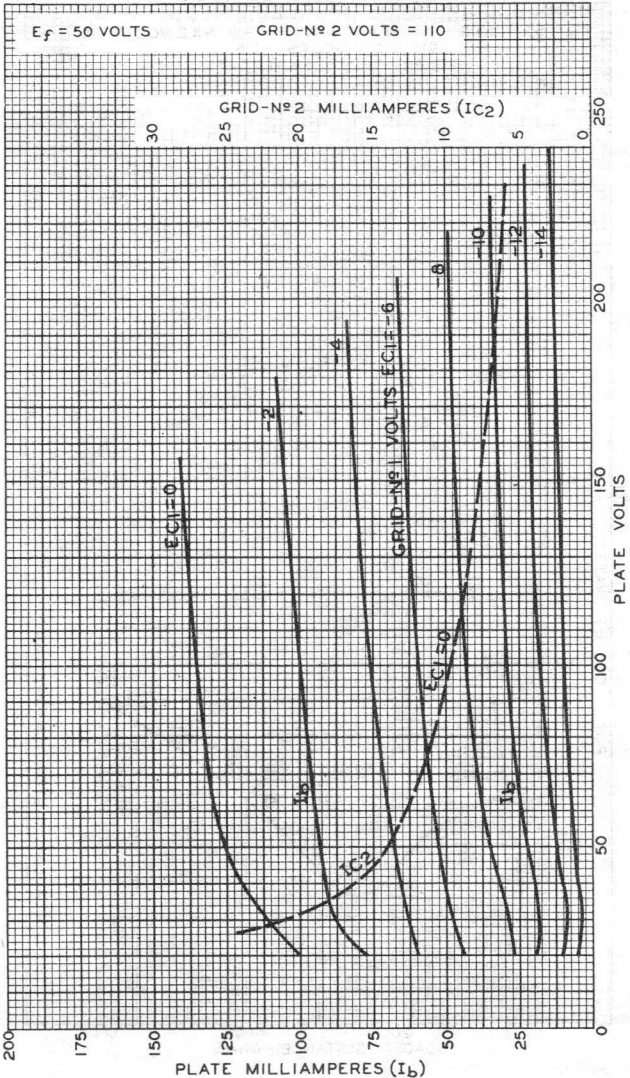

OCT. 8, 1945

RCA VICTOR DIVISION
RADIO CORPORATION OF AMERICA, HARRISON, NEW JERSEY

92CM-6603

50B5



50B5

OPERATION CHARACTERISTICS PENTODE CONNECTION

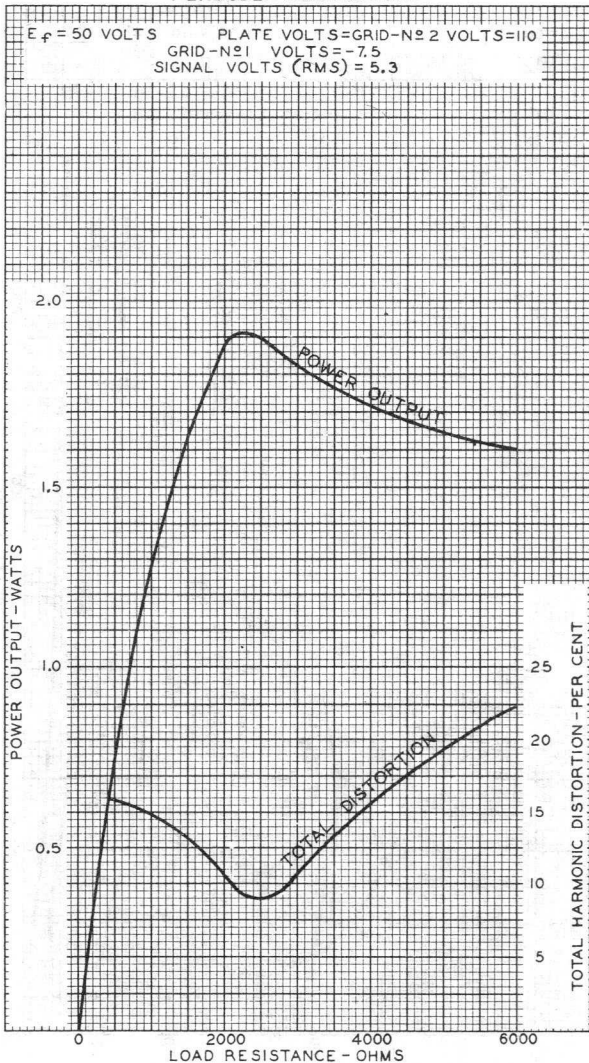



50C5

BEAM POWER TUBE

7-PIN MINIATURE TYPE

50C5

GENERAL DATA

Electrical:

Heater, for Unipotential Cathode:

Voltage (AC or DC)	50 + 10%	volts
Current	0.15	amp

Direct Interelectrode Capacitances (Approx.):^o

Grid No.1 to plate.	0.6	$\mu\mu\text{f}$
Grid No.1 to cathode & grid No.3, grid No.2, and heater	13	$\mu\mu\text{f}$
Plate to cathode & grid No.3, grid No.2, and heater	8.5	$\mu\mu\text{f}$

Mechanical:

Operating Position. Any

Maximum Overall Length. 2-5/8"

Maximum Seated Length 2-3/8"

Length, Base Seat to Bulb Top (Excluding tip). . . 2" \pm 3/32"

Diameter. 0.650" to 0.750"

Dimensional Outline See General Section

Bulb. T5-1/2

Base. Small Button Miniature 7-Pin (JEDEC No. E7-1)

Basing Designation for BOTTOM VIEW. 7CV

Pin 1- Cathode,
Grid No.3

Pin 2- Grid No.1

Pin 3- Heater

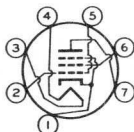

Pin 4- Heater

Pin 5- Grid No.1

Pin 6- Grid No.2

Pin 7- Plate

AMPLIFIER — Class A₁

Maximum Ratings, Design-Maximum Values:

PLATE VOLTAGE.	150	max.	volts
GRID-No.2 (SCREEN-GRID) VOLTAGE.	130	max.	volts
GRID-No.1 (CONTROL-GRID) VOLTAGE.	0	max.	volts
GRID-No.2 INPUT.	1.4	max.	watts
PLATE DISSIPATION.	7	max.	watts
PEAK HEATER-CATHODE VOLTAGE:			
Heater negative with respect to cathode.	200	max.	volts
Heater positive with respect to cathode.	200 [▲]	max.	volts
BULB TEMPERATURE (At hottest point on bulb surface)			
	220	max.	°C

← Indicates a change.

50C5



50C5

BEAM POWER TUBE

→ Typical Operation and Characteristics:

Plate Voltage.	120	volts
Grid-No.2 Voltage.	110	volts
Grid-No.1 Voltage.	-8	volts
Peak AF Grid-No.1 Voltage.	8	volts
Zero-Signal Plate Current.	49	ma
Max.-Signal Plate Current.	50	ma
Zero-Signal Grid-No.2 Current.	4	ma
Max.-Signal Grid-No.2 Current.	8.5	ma
Plate Resistance (Approx.)	10000	ohms
Transconductance	7500	μmhos
Load Resistance.	2500	ohms
Total Harmonic Distortion.	10	%
Max.-Signal Power Output	2.3	watts

Maximum Circuit Values:

Grid-No.1-Circuit Resistance:

For fixed-bias operation	0.1 max.	megohm
For cathode-bias operation	0.5 max.	megohm

○ without external shield.

▲ The dc component must not exceed 100 volts.

NOTE: Except for a different basing arrangement, which simplifies the problem of meeting Underwriters' Laboratories requirements in the design of ac/dc receivers, the 50C5 is similar to the miniature type 50B5.

→ Indicates a change.



50C5

50C5

AVERAGE CHARACTERISTICS

$E_p = 50$ VOLTS
GRID-№2 VOLTS = 110

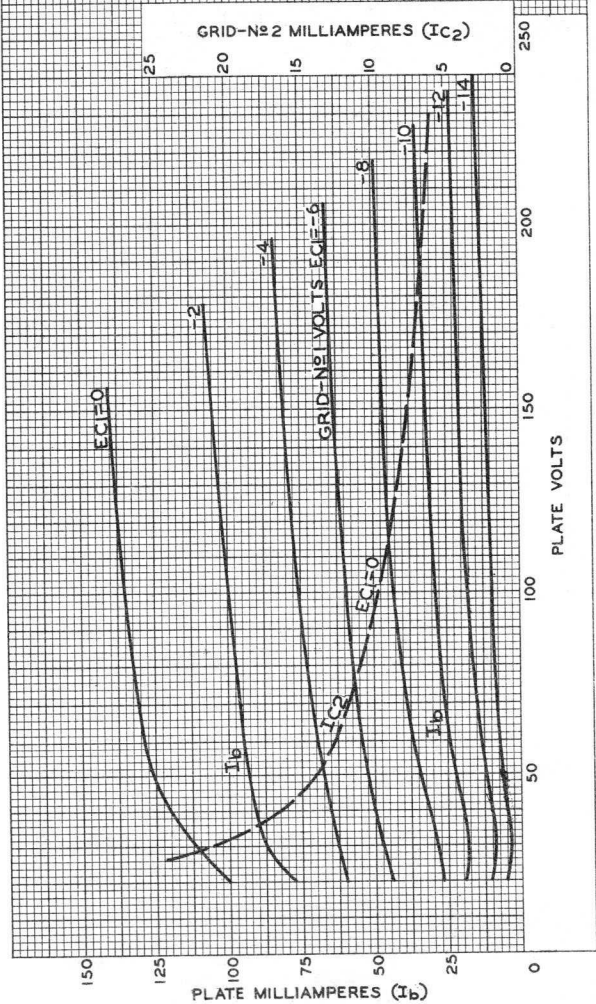

PLATE MILLIAMPERES (I_b)

ELECTRON TUBE DIVISION

RADIO CORPORATION OF AMERICA, HARRISON, NEW JERSEY

92CM-6603

50C5



50C5

OPERATION CHARACTERISTICS

$E_f = 50$ VOLTS
PLATE VOLTS = 120
GRID-№2 VOLTS = 110
GRID-№1 VOLTS = -8
RMS SIGNAL VOLTS = 5.65

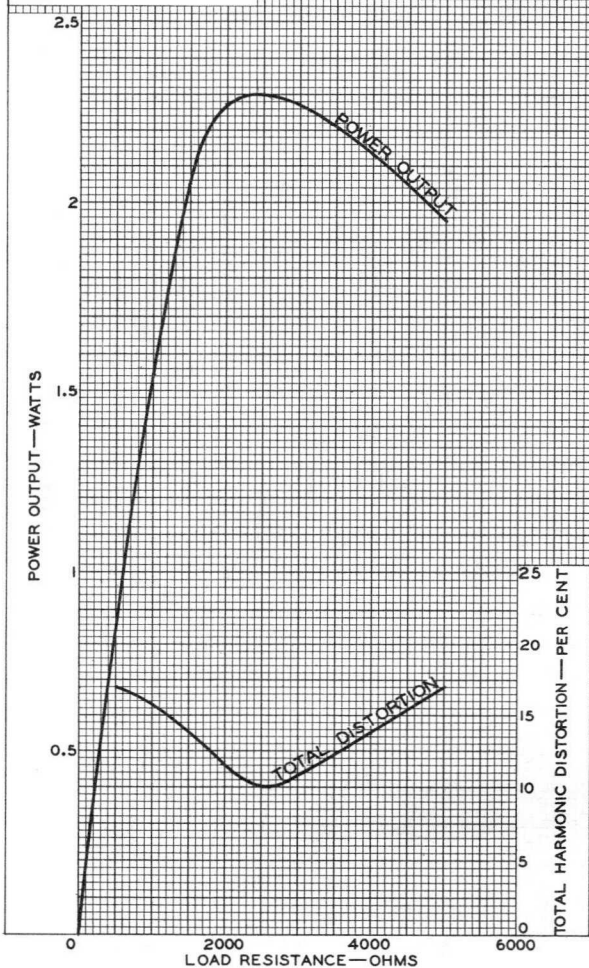



50DC4

HALF-WAVE VACUUM RECTIFIER

7-PIN MINIATURE TYPE

50DC4

GENERAL DATA

Electrical:

	<i>Without Panel Lamp</i>	<i>With No.40 or No.47 Panel Lamp</i>	
Heater, for Unipotential Cathode:			
Voltage:			
Entire heater (Pins 3 and 4)	50 ± 10%	45 ± 10%	ac or dc volts
Panel-lamp section (Pins 4 and 6)	7.5	5.5	ac or dc volts
Current:			
Between pins 3 and 4.	0.15	-	amp
Between pins 3 and 6.	-	0.15	amp

Mechanical:

Operating Position.	Any
Maximum Overall Length.	2-5/8"
Maximum Seated Length.	2-3/8"
Length, Base Seat to Bulb Top (Excluding tip)	2" ± 3/32"
Diameter.	0.650" to 0.750"
Dimensional Outline.	See General Section
Bulb.	T5-1/2
Base.	Small-Button Miniature 7-Pin (JEDEC No. E7-1)
Basing Designation for BOTTOM VIEW.	5BQ

- Pin 1 - No Connection
- Pin 2 - No Connection
- Pin 3 - Heater
- Pin 4 - Heater
- Pin 5 - Plate

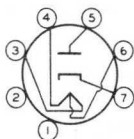

- Pin 6 - Heater Tap
- Pin 7 - Cathode
- Panel-lamp heater section is between pins 4 and 6.

HALF-WAVE RECTIFIER

Maximum Ratings, Design-Maximum Values:

PEAK INVERSE PLATE VOLTAGE.	330 max.	volts
PEAK PLATE CURRENT.	720 max.	ma
DC OUTPUT CURRENT:		
With panel lamp and no shunting resistor.	70 max.	ma
With panel lamp and shunting resistor†	110 max.	ma
Without panel lamp.	120 max.	ma
PANEL-LAMP-SECTION VOLTAGE (RMS):		
When panel lamp fails	16.5 max.	volts

† Required when the dc output current is greater than 70 milliamperes.

50DC4



50DC4

HALF-WAVE VACUUM RECTIFIER

PEAK HEATER-CATHODE VOLTAGE:

Heater negative with respect to cathode.	330 max.	volts
Heater positive with respect to cathode.	330 max.	volts

Typical Operation:

With panel lamp in accompanying half-wave circuit with capacitor input to filter

AC Plate-Supply Voltage (RMS)	117	117	117	117	volts
Filter-Input Capacitor	40	40	40	40	μ f
Minimum Total Effective Plate-Supply Impedance	15	15	15	15	ohms
Panel-Lamp Shunting Resistor	450	200	100	75	ohms
DC Output Current	70	80	90	100	ma

Without panel lamp in half-wave circuit with capacitor input to filter

AC Plate-Supply Voltage (RMS)	117	volts
Filter-Input Capacitor	40	μ f
Minimum Total Effective Plate-Supply Impedance	15	ohms
DC Output Current	110	ma
DC Output Voltage at Input to Filter (Approx.):		
At half-load current of 55 ma.	130	volts
At full-load current of 110 ma.	110	volts
Voltage Regulation (Approx.):		
Half-load to full-load current	20	volts

HALF-WAVE CIRCUIT

With panel lamp No.40 or No.47

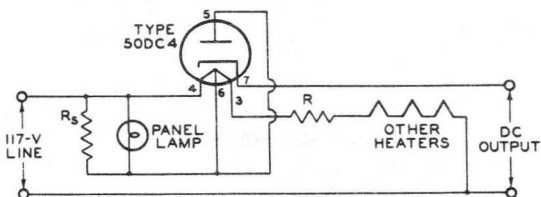

DROP ACROSS R AND ALL HEATERS (WITH PANEL LAMP) SHOULD EQUAL 117 VOLTS AT 0.15 AMPERE. R_s = SHUNTING RESISTOR REQUIRED WHEN DC OUTPUT CURRENT EXCEEDS 70 MILLIAMPERES

92CS-9923

Information furnished by RCA is believed to be accurate and reliable. However, no responsibility is assumed by RCA for its use; nor for any infringements of patents or other rights of third parties which may result from its use. No license is granted by implication or otherwise under any patent or patent rights of RCA.



50DC4

50DC4

AVERAGE PLATE CHARACTERISTIC

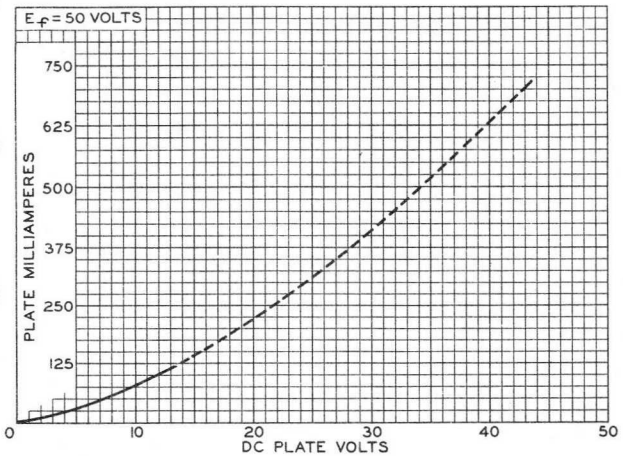

92CS-9893



50EH5

Power Pentode

7-PIN MINIATURE TYPE

The 50EH5 is the same as the 6EH5 except for the following items:

Heater, for Unipotential Cathode:

Voltage (AC or DC) 50 volts
Current 0.15 amp

50FE5

Beam Power Tube

For Audio-Output Stages of Low-Cost, Compact Stereophonic Equipment

The 50FE5 is the same as the 6FE5 except for the following items:

Heater, for Unipotential Cathode:

Voltage (AC or DC) $50 \pm 10\%$ volts
Current at 50 volts 0.15 amp

Peak Heater-Cathode Voltage:

Heater negative with respect to cathode . 200 max. volts
Heater positive with respect to cathode . 200★ max. volts

★ The dc component must not exceed 100 volts.



RADIO CORPORATION OF AMERICA
Electron Tube Division
Harrison, N. J.

DATA
8-60

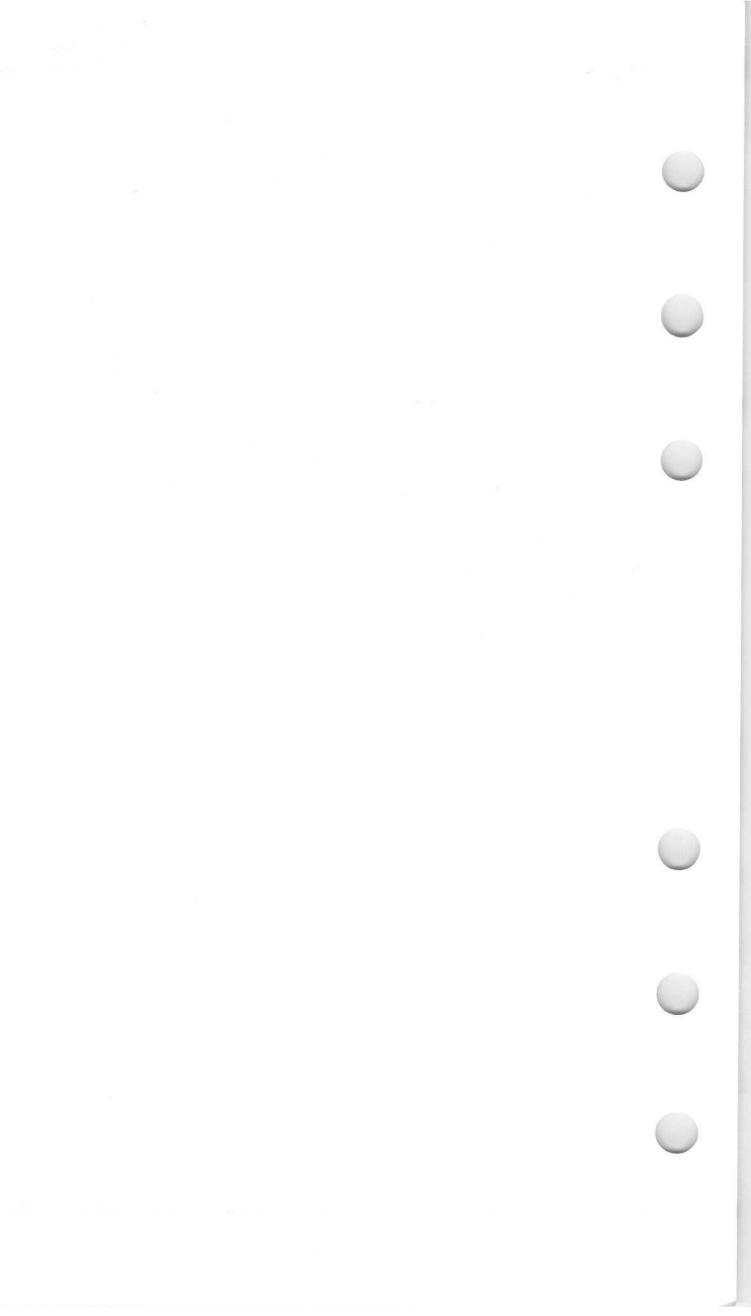



50L6-GT

50L6-GT



BEAM POWER AMPLIFIER

Heater	Coated Unipotential Cathode	
Voltage	50	a-c or d-c volts
Current	0.15	amp.
Maximum Overall Length		3-5/16"
Maximum Seated Height		2-3/4"
Maximum Diameter		1-5/16"
Bulb		T-9
Base	Intermediate Shell Octal	7-Pin
Pin 1 - No Connection		Pin 5 - Grid
Pin 2 - Heater		Pin 7 - Heater
Pin 3 - Plate		Pin 8 - Cathode
Pin 4 - Screen		
Mounting Position		Any



BOTTOM VIEW (G-7AC)
AMPLIFIER

Plate Voltage	200 max.	volts
Screen Voltage	117 max.	volts
Plate Dissipation	10 max.	watts
Screen Dissipation	1.25 max.	watts

Typical Operation and Characteristics - Class A₁ Amplifier:

Plate	110	200	volts
Screen	110	110	volts
Grid *	-7.5	-8	volts
Peak A-F Grid Voltage	7.5	8	volts
Zero-Sig. Plate Cur.	49	50	ma.
Max.-Sig. Plate Cur.	50	55	ma.
Zero-Sig. Screen Cur.	4	2	approx. ma.
Max.-Sig. Screen Cur.	11	7	approx. ma.
Plate Resistance	13000	30000	approx. ohms
Transconductance	9000	9500	μmhos
Load Resistance	2000	3000	ohms
Total Harmonic Dist.	10	10	%
Power Output	2.1	4.3	watts

■ In circuits where the cathode is not directly connected to the heater, the potential difference between heater and cathode should be kept as low as possible.

* The type of input coupling should not introduce too much resistance in the grid circuit. Transformer- or impedance-coupling devices are recommended. When the grid circuit has a resistance not higher than 0.1 megohm, fixed bias may be used; for higher values, cathode bias is required. With cathode bias, the grid circuit may have a resistance not to exceed 0.5 megohm.

Curves under type 25L6-GT also apply to the 50L6-GT.

← Indicates a change.

Sept. 2, 1941

RCA RADIOTRON DIVISION
RCA MANUFACTURING COMPANY, INC.

DATA

50L6-GT



50L6-GT

OPERATION CHARACTERISTICS

$E_f = 50$ VOLTS PLATE VOLTS = 200 SCREEN VOLTS = 110
CONTROL-GRID VOLTS = -8
SIGNAL VOLTS (RMS) = 5.65

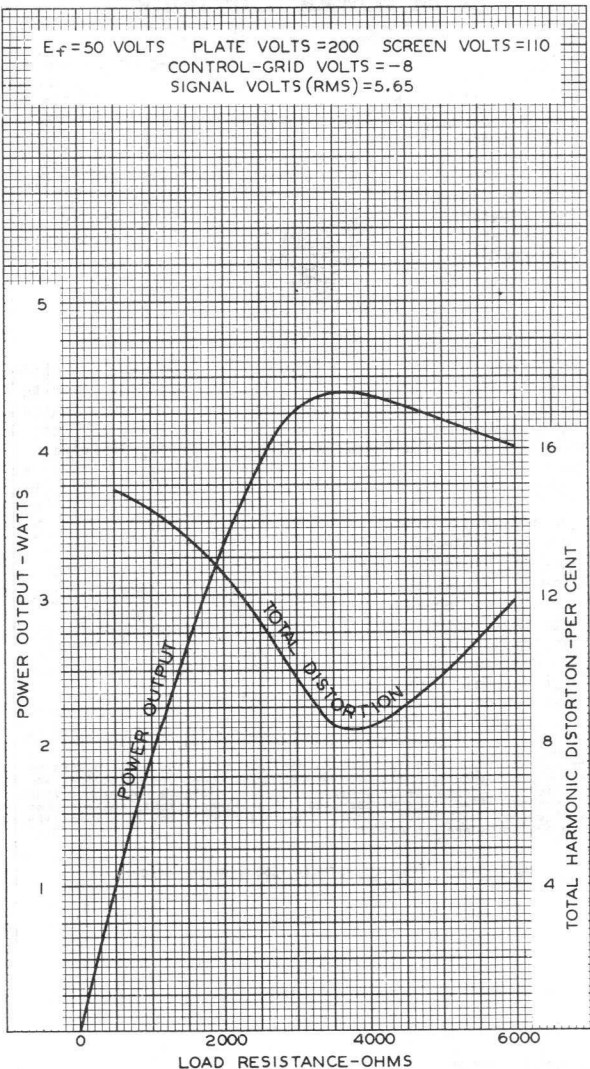

AUG. 7, 1941

RCA RADIOTRON DIVISION
RCA MANUFACTURING COMPANY, INC.

92C-6308



50L6-GT

50L6-GT AVERAGE PLATE CHARACTERISTICS PENTODE CONNECTION

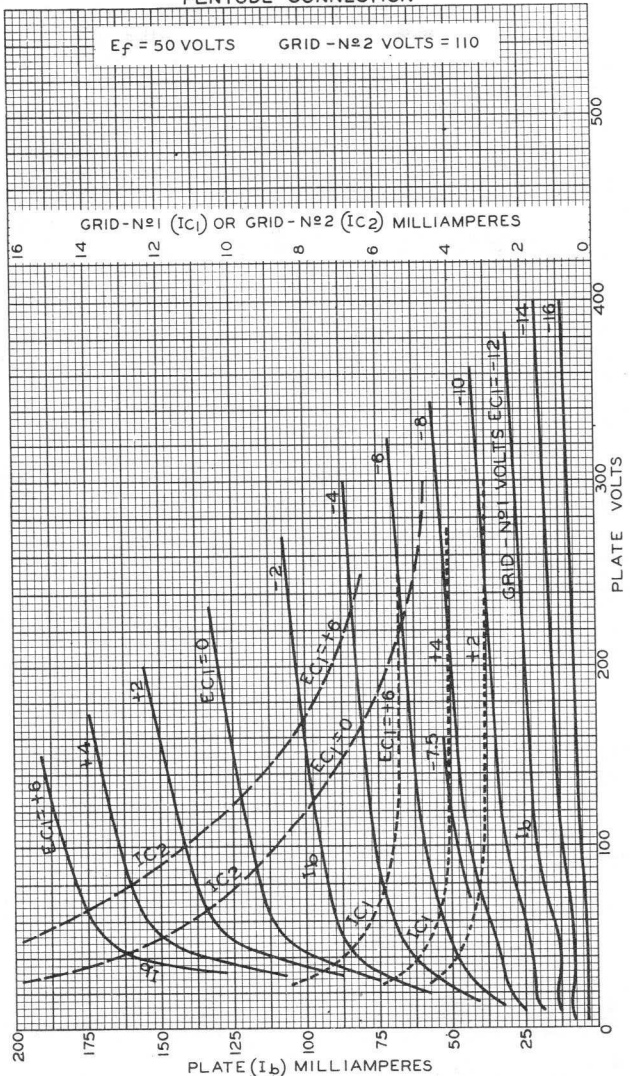

JAN. 27, 1950

TUBE DEPARTMENT
RADIO CORPORATION OF AMERICA, HARRISON, NEW JERSEY

92CM-6314RI

50L6-GT



50L6-GT

AVERAGE PLATE CHARACTERISTICS

TRIODE CONNECTION

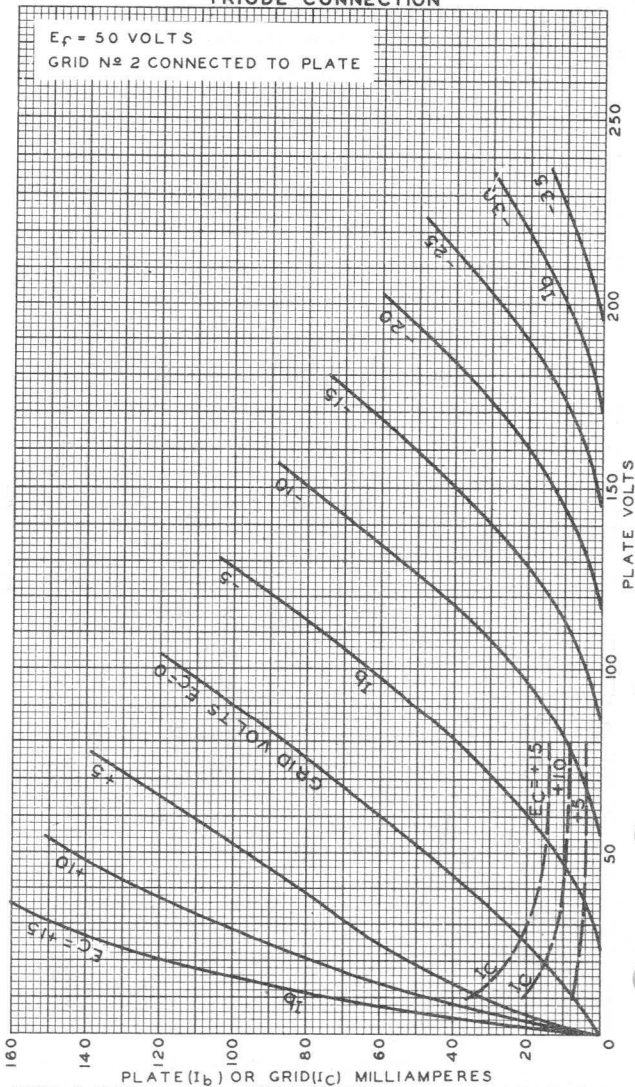

APRIL 6, 1948

TUBE DEPARTMENT

RADIO CORPORATION OF AMERICA, HARRISON, NEW JERSEY

92CM-6316RI

Power Pentode

7-PIN MINIATURE TYPE

GENERAL DATA

Electrical:

Heater, for Unipotential Cathode:

Voltage (AC or DC)	60 ± 10%	volts
Current at 60 volts	0.1	amp

Direct Interelectrode Capacitances

(Approx.): [▲]		
Grid No.1 to plate	0.65	μmf
Grid No.1 to cathode & grid No.3, grid No.2, and heater	17	μmf
Plate to cathode & grid No.3, grid No.2, and heater	9	μmf

Characteristics, Class A₁ Amplifier:

Plate Supply Voltage	110	volts
Grid-No.2 Supply Voltage	115	volts
Cathode Resistor	62	ohms
Plate Resistance (Approx.)	17500	ohms
Transconductance	13500	μmhos
Plate Current	36	ma
Grid-No.2 Current	10	ma

Mechanical:

Operating Position	Any
Maximum Overall Length	2-5/8"
Maximum Seated Length	2-3/8"
Length, Base Seat to Bulb Top (Excluding tip)	2" ± 3/32"
Diameter	0.650" to 0.750"
Dimensional Outline	See <i>General Section</i>
Bulb	T5-1/2
Base	Small-Button Miniature 7-Pin (JEDEC No.E7-1)
Basing Designation for BOTTOM VIEW	7CV

Pin 1 - Cathode,
Grid No.3
Pin 2 - Grid No.1
Pin 3 - Heater

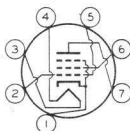

Pin 4 - Heater
Pin 5 - Grid No.1
Pin 6 - Grid No.2
Pin 7 - Plate

AF POWER AMPLIFIER — Class A₁

Maximum Ratings, Design-Maximum Values:

PLATE VOLTAGE	150	max.	volts
GRID-No.2 (SCREEN-GRID) VOLTAGE	130	max.	volts
GRID-No.1 (CONTROL-GRID) VOLTAGE:			
Positive-bias value	0	max.	volts
GRID-No.2 INPUT	2	max.	watts
PLATE DISSIPATION	5.5	max.	watts



60FX5

PEAK HEATER-CATHODE VOLTAGE:

Heater negative with respect to cathode.	200	max.	volts
Heater positive with respect to cathode.	200 [•]	max.	volts
BULB TEMPERATURE (At hottest point on bulb surface).	225	max.	°C

Typical Operation:

Plate Supply Voltage.	110		volts
Grid-No.2 Supply Voltage.	115		volts
Cathode Resistor.	62		ohms
Peak AF Grid-No.1 Voltage	3		volts
Zero-Signal Plate Current	36		ma
Max.-Signal Plate Current	35		ma
Zero-Signal Grid-No.2 Current	10		ma
Max.-Signal Grid-No.2 Current	12		ma
Load Resistance	3000		ohms
Total Harmonic Distortion	8		%
Max.-Signal Power Output.	1.3		watts

Maximum Circuit Values:

Grid-No.1-Circuit Resistance:

For fixed-bias operation.	0.1	max.	megohm
For cathode-bias operation.	0.5	max.	megohm

[▲] Without external shield.

[•] The dc component must not exceed 100 volts.



AVERAGE CHARACTERISTICS

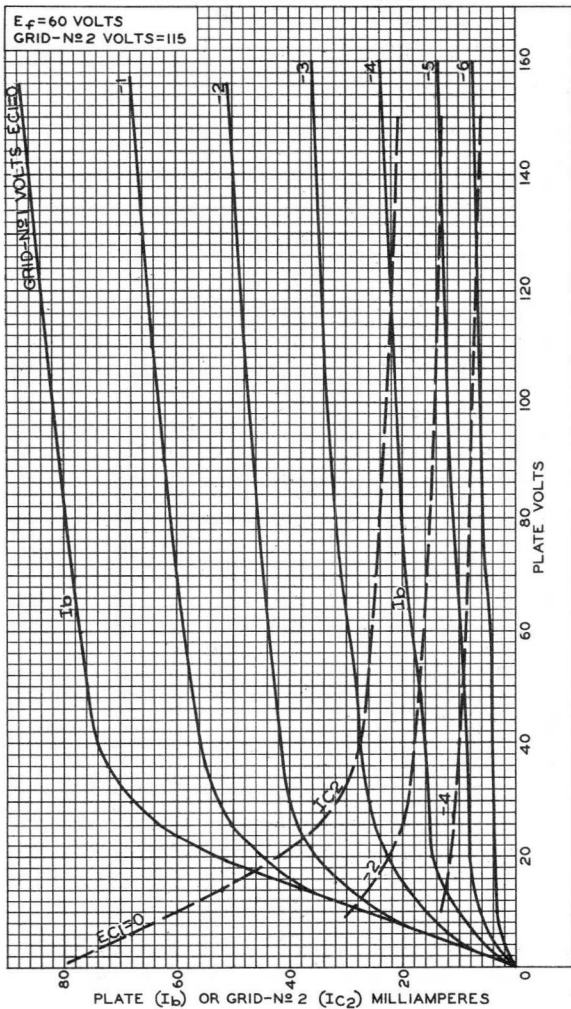

60FX5

OPERATION CHARACTERISTICS

$E_f = 60$ VOLTS
PLATE SUPPLY VOLTS = 110
GRID- N_2 SUPPLY VOLTS = 115
CATHODE RESISTOR (OHMS) = 62
CATHODE-BYPASS CAPACITOR (μf) = 100
SIGNAL VOLTS (RMS) = 2.1

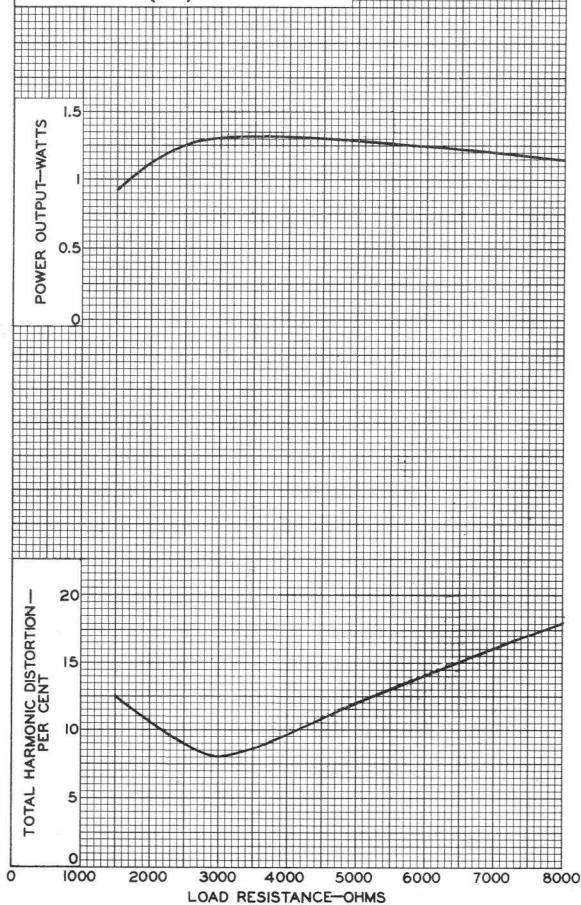

92CM-10545



Beam Power Tube

9-PIN MINIATURE TYPE
For High-Fidelity Audio-
Amplifier Applications

GENERAL DATA

Electrical:

Heater, for Unipotential Cathode:		
Voltage (AC or DC)	6.3 ± 10%	volts ←
Current at 6.3 volts	0.45	amp
Direct Interelectrode Capacitances: ⁰		
Grid No.1 to plate	0.4 max.	μf ←
Grid No.1 to cathode & grid No.3, grid No.2, and heater	9	μf
Plate to cathode & grid No.3, grid No.2, and heater	6	μf

Characteristics, Class A₁ Amplifier:

Plate Voltage	250	volts
Grid-No.2 Voltage	250	volts
Grid-No.1 Voltage	-15	volts
Plate Resistance (Approx.)	73000	ohms
Transconductance	4800	μhos
Plate Current	46	ma
Grid-No.2 Current	3.5	ma
Grid-No.1 Voltage (Approx.) for plate μa = 100	-40	volts

Mechanical:

Operating Position	Any
Maximum Overall Length	3-1/16"
Maximum Seated Length	2-13/16"
Length, Base Seat to Bulb Top (Excluding tip)	2-7/16" ± 3/32"
Maximum Diameter0.750" to 0.875"
Dimensional Outline	See <i>General Section</i>
BulbT6-1/2
Base	Small-Button Noval 9-Pin (JEDEC No.E9-1)
Basing Designation for BOTTOM VIEW	9EU

- Pin 1-Grid No.2
- Pin 2-No Connection
- Pin 3-Grid No.1
- Pin 4-Heater
- Pin 5-Heater

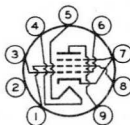

- Pin 6-Grid No.1
- Pin 7-Grid No.3,
Cathode
- Pin 8-Grid No.2
- Pin 9-Plate

PUSH-PULL AF POWER AMPLIFIER — Class AB₁

Maximum Ratings, Design-Maximum Values:

PLATE VOLTAGE	440 max.	volts ←
GRID-No.2 (SCREEN-GRID) VOLTAGE	330 max.	volts

← indicates a change.



GRID-No.2 INPUT	2	max.	watts
PLATE DISSIPATION	12	max.	watts
PEAK HEATER-CATHODE VOLTAGE:			
Heater negative with respect to cathode	200	max.	volts
Heater positive with respect to cathode	200	max.	volts
BULB TEMPERATURE (At hottest point on bulb surface)			
	250	max.	°C

Typical Operation with Fixed Bias:

Values are for 2 tubes

Plate Voltage	250	350	400	volts
Grid-No.2 Voltage	250	280	290	volts
Grid-No.1 (Control-Grid) Voltage	-15	-22	-25	volts
Peak AF Grid-No.1-to-Grid-No.1 Voltage	30	44	50	volts
Zero-Signal Plate Current	92	58	50	ma
Max.-Signal Plate Current	105	106	107	ma
Zero-Signal Grid-No.2 Current	7	3.5	2.5	ma
Max.-Signal Grid-No.2 Current	16	14	13.7	ma
Effective Load Resistance (Plate to plate)	8000	7500	8000	ohms
Total Harmonic Distortion	2	1.5	2	%
Max.-Signal Power Output	12.5	20	24	watts

Typical Operation with Cathode Bias:

Values are for 2 tubes

Plate Supply Voltage	300	310	volts
Grid-No.2 Supply Voltage	300	310	volts
Cathode Resistor	230	270	ohms
Peak AF Grid-No.1-to-Grid-No.1 Voltage	48	55	volts
Zero-Signal Plate Current	80	77	ma
Max.-Signal Plate Current	96	92	ma
Zero-Signal Grid-No.2 Current	6	5	ma
Max.-Signal Grid-No.2 Current	14	14	ma
Effective Load Resistance (Plate to plate)	5500	6000	ohms
Total Harmonic Distortion	2	4	%
Max.-Signal Power Output	15	17	watts

Maximum Circuit Values:

Grid-No.1-Circuit Resistance:•

For fixed-bias operation	0.5	max.	megohm
For cathode-bias operation	1	max.	megohm

PUSH-PULL AF POWER AMPLIFIER — Class AB₁

Grid No.2 of each tube connected to tap on plate winding of output transformer

→ **Maximum Ratings, Design-Maximum Values:**

PLATE AND GRID-No.2 (SCREEN-GRID) SUPPLY VOLTAGE	410	max.	volts
--	-----	------	-------

→ Indicates a change.





7025

7025

HIGH-MU TWIN TRIODE

9-PIN MINIATURE TYPE

For high-fidelity audio-amplifier applications critical as to noise and hum. In other respects, the 7025 is similar to the 12AX7.

GENERAL DATA

Electrical:

Heater, for Unipotential Cathodes:

Heater arrangement	Series	Parallel	
Voltage	12.6	6.3	ac or dc volts
Current	0.15	0.3 amp

Direct Interelectrode Capacitances (Approx.):^o

	Unit No. 1	Unit No. 2	
Grid to plate	1.7	1.7 $\mu\mu\text{f}$
Grid to cathode and heater	1.6	1.6 $\mu\mu\text{f}$
Plate to cathode and heater	0.46	0.34 $\mu\mu\text{f}$

Equivalent-Noise and Hum Voltage (Referenced to Grid):

Values are for Each Unit

Average Value (RMS) 1.8 microvolts

Measured in "true rms" units under the following conditions: heater volts = 6.3 ac (parallel connection), center-tap of heater transformer connected to ground, dc plate-supply volts = 250, plate load resistor (megohms) = 0.1, cathode resistor (ohms) = 2700, cathode-bypass capacitor (μf) = 100, grid resistor (ohms) = 0, and amplifier covering frequency range between 25 and 10,000 cps.

Maximum Value (RMS) 7 microvolts

Measured in "true rms" units under the same conditions as for "Average Value" except that the cathode resistor is unbypassed, and grid resistor (megohms) = 0.05.

Characteristics, Class A₁ Amplifier (Each Unit):

Plate Voltage	100	250	volts
Grid Voltage	-1	-2	volts
Amplification Factor	100	100	
Plate Resistance (Approx.)	80000	62500	ohms
Transconductance	1250	1600	μmhos
Plate Current	0.5	1.2	ma

Mechanical:

Operating Position	Any
Maximum Overall Length	2-3/16"
Maximum Seated Length	1-15/16"
Length, Base Seat to Bulb Top (Excluding tip)	1-9/16" \pm 3/32"
Diameter	0.750" to 0.875"
Dimensional Outline	See General Section
Bulb	T6-1/2

^o: See next page.



7025

HIGH-MU TWIN TRIODE

Base Small-Button Noval 9-Pin (JEDEC No.E9-1)
 Basing Designation for BOTTOM VIEW 9A

Pin 1 - Plate of
 Unit No.2

Pin 2 - Grid of
 Unit No.2

Pin 3 - Cathode of
 Unit No.2

Pins 4 & 9 - Heater of
 Unit No.2

Pins 5 & 9 - Heater of
 Unit No.1

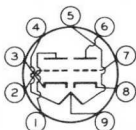

Pin 6 - Plate of
 Unit No.1

Pin 7 - Grid of
 Unit No.1

Pin 8 - Cathode of
 Unit No.1

Pin 9 - Heater
 Mid-Tap

AMPLIFIER — Class A₁

Values are for Each Unit

Maximum Ratings, Design-Maximum Values:

PLATE VOLTAGE. 330 max. volts

GRID VOLTAGE:

Negative-bias value. 55 max. volts

Positive-bias value. 0 max. volts

PLATE DISSIPATION. 1.2 max. watts

PEAK HEATER-CATHODE VOLTAGE:

Heater negative with respect to cathode. 200 max. volts

Heater positive with respect to cathode. 200[▲] max. volts

Typical Operation as Resistance-Coupled Amplifier (Each Unit):

See RESISTANCE-COUPLED AMPLIFIER CHART No.25
 at front of Receiving Tube Section

[○] Without external shield.

[▲] The dc component must not exceed 100 volts.

OPERATING CONSIDERATIONS

Parallel heater arrangement is recommended for use in high-gain, resistance-coupled-amplifier applications such as in the preamplifier stages of phonographs, microphones, and tape recorders. With closely paired, electrostatically shielded heater leads, a hum-balance control is unnecessary when the center-tap of the heater transformer is connected to ground. In applications where the heater-transformer winding does not have a center-tap, a 100-ohm hum-balancing potentiometer should be connected across the heater leads with the slider connected to ground.



7025

7025

AVERAGE PLATE CHARACTERISTICS EACH UNIT

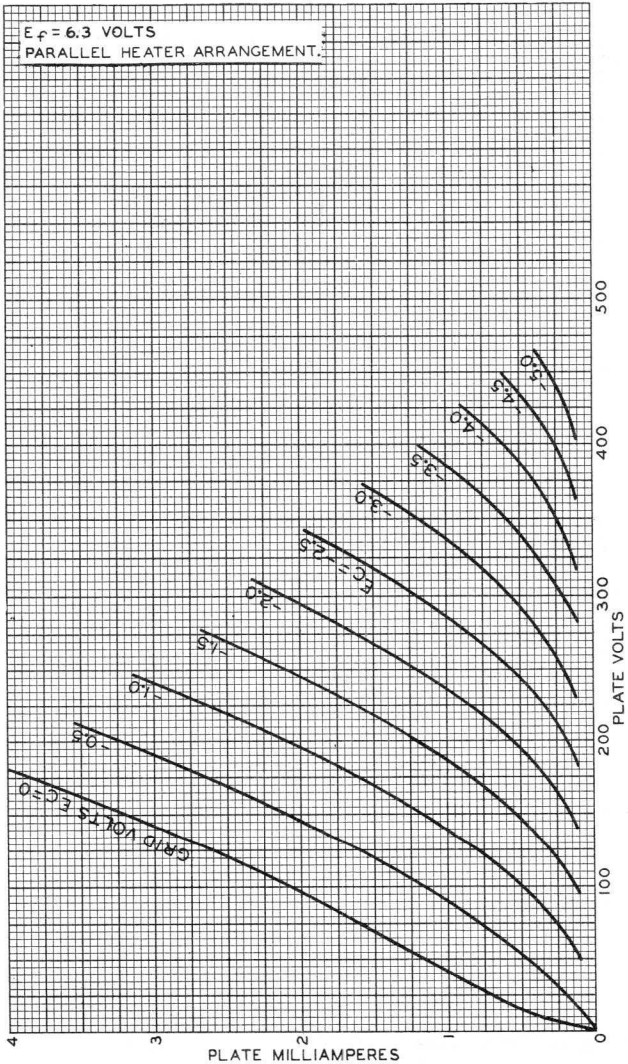

7025



7025

AVERAGE CHARACTERISTICS
EACH UNIT

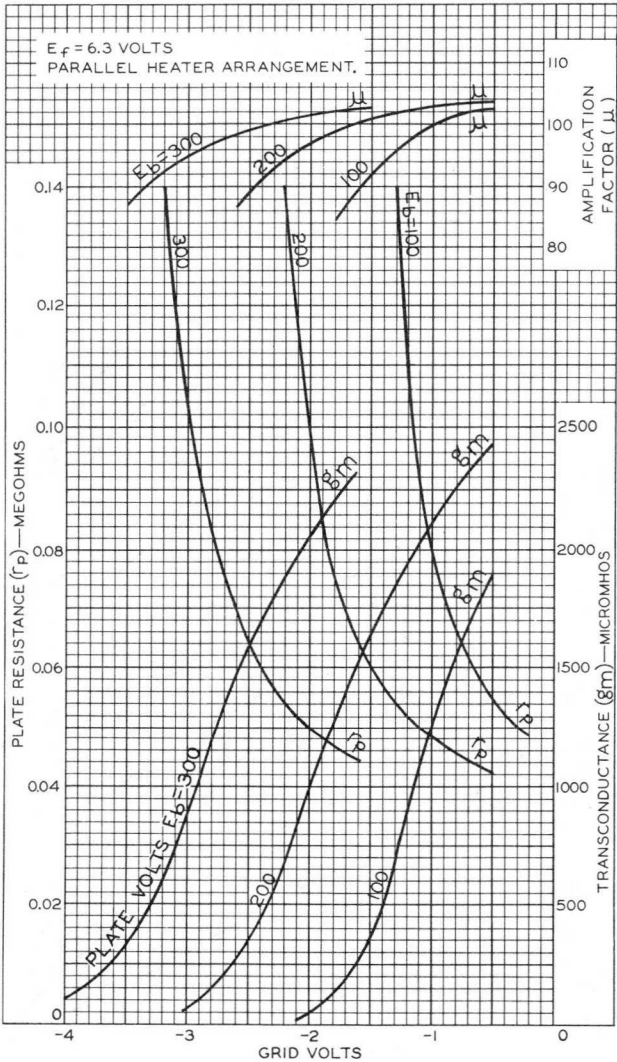

ELECTRON TUBE DIVISION

92CM-6880

RADIO CORPORATION OF AMERICA, HARRISON, NEW JERSEY



7027-A

7027-A

BEAM POWER TUBE

For high-fidelity audio-amplifier applications

Supersedes Type 7027

GENERAL DATA

Electrical:

Heater, for Unipotential Cathode:

Voltage (AC or DC)	6.3	volts
Current	0.9	amp

Direct Interelectrode Capacitances:^o

Grid No.1 to plate.	1.5	$\mu\mu\text{f}$
Grid No.1 to cathode & grid No.3, grid No.2, and heater	10	$\mu\mu\text{f}$
Plate to cathode & grid No.3, grid No.2, and heater	7.5	$\mu\mu\text{f}$

Characteristics, Class A₁ Amplifier:

Plate Voltage	250	volts
Grid-No.2 Voltage	250	volts
Grid-No.1 Voltage	-14	volts
Plate Resistance (Approx.)	22500	ohms
Transconductance	6000	μmhos
Plate Current	72	ma
Grid-No.2 Current	5	ma

Mechanical:

Operating Position.	Any
Maximum Overall Length.	4.62"
Maximum Seated Length	4.06"
Maximum Diameter.	1.63"
Bulb.	T12
Base.	Small-Wafer Octal 8-Pin with "950" Sleeve (JEDEC Group 1, No.88-191)

Basing Designation for BOTTOM VIEW. 8HY

- Pin 1 - Grid No.2
- Pin 2 - Heater
- Pin 3 - Plate
- Pin 4 - Grid No.2
- Pin 5 - Grid No.1

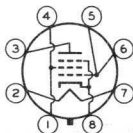

- Pin 6 - Grid No.1
- Pin 7 - Heater
- Pin 8 - Cathode,
Grid No.3

PUSH-PULL AF POWER AMPLIFIER — Class AB₁

Maximum Ratings, Design-Maximum Values:

PLATE VOLTAGE	600	max.	volts
GRID-No.2 (SCREEN-GRID) VOLTAGE	500	max.	volts
GRID-No.2 INPUT	5	max.	watts
PLATE DISSIPATION	35	max.	watts
PEAK HEATER-CATHODE VOLTAGE:			
Heater negative with respect to cathode.	200	max.	volts
Heater positive with respect to cathode.	200 [▲]	max.	volts

7027-A



7027-A

BEAM POWER TUBE

Typical Operation with Fixed Bias:

Values are for 2 tubes

Plate Voltage	400	450	540	volts
Grid-No.2 Voltage	300	350	400	volts
Grid-No.1 (Control-Grid) Voltage*	-25	-30	-38	volts
Peak AF Grid-No.1-to-Grid-No.1 Voltage	50	60	76	volts
Zero-Signal Plate Current	102	95	100	ma
Max.-Signal Plate Current	152	194	220	ma
Zero-Signal Grid-No.2 Current	6	3.4	5	ma
Max.-Signal Grid-No.2 Current	17	19.2	21.4	ma
Effective Load Resistance (Plate to plate).	6600	6000	6500	ohms
Total Harmonic Distortion	2	1.5	2	%
Max.-Signal Power Output.	34	50	76	watts

Typical Operation with Cathode Bias:

Values are for 2 tubes

Plate Supply Voltage.	400	380	425	volts
Grid-No.2 Supply Voltage.	300	380	425	volts
Cathode Resistor.	200	180	200	ohms
Peak AF Grid-No.1-to-Grid-No.1 Voltage	57	68.5	86	volts
Zero-Signal Plate Current	112	138	150	ma
Max.-Signal Plate Current	128	170	196	ma
Zero-Signal Grid-No.2 Current	7	5.6	8	ma
Max.-Signal Grid-No.2 Current	16	20	20	ma
Effective Load Resistance (Plate to plate).	6600	4500	3800	ohms
Total Harmonic Distortion	2	3.5	4	%
Max.-Signal Power Output.	32	36	44	watts

Maximum Circuit Values:

Grid-No.1-Circuit Resistance:*				
For fixed-bias operation.	0.1 max.			megohm
For cathode-bias operation.	0.5 max.			megohm

PUSH-PULL AF POWER AMPLIFIER — Class AB₁

Grid No. 2 of each tube connected to tap on
plate winding of output transformer

Maximum Ratings, Design-Maximum Values:

PLATE AND GRID-No.2 (SCREEN-GRID) SUPPLY VOLTAGE.	600 max.		volts
GRID-No.2 INPUT	4.5 max.		watts
PLATE DISSIPATION	35 max.		watts
PEAK HEATER-CATHODE VOLTAGE:			
Heater negative with respect to cathode.	200 max.		volts
Heater positive with respect to cathode.	200 [▲] max.		volts



7027-A

7027-A

BEAM POWER TUBE

Typical Operation:

Values are for 2 tubes

Plate Supply Voltage.	410	volts
Grid-No.2 Supply Voltage.	*	volts
Cathode Resistor.	220	ohms
Peak AF Grid-No.1-to-Grid-No.1 Voltage. .	68	volts
Zero-Signal Cathode Current	134	ma
Max.-Signal Cathode Current	155	ma
Effective Load Resistance (Plate to plate).	8000	ohms
Total Harmonic Distortion	1.6	%
Max.-Signal Power Output.	24	watts

Maximum Circuit Values:

Grid-No.1-Circuit Resistance:[•]
 For cathode-bias operation. 0.5 max. megohm

^o Without external shield.

[▲] The dc component must not exceed 100 volts.

[•] The type of input coupling network used should not introduce too much resistance in the grid-No.1 circuit. Transformer- or impedance-coupling devices are recommended.

^{*} Obtained from taps on the primary winding of the output transformer. The taps are located on each side of the center-tap (B⁺) so as to apply 43 per cent of the plate signal voltage to grid-No.2 of each output tube.

OPERATING CONSIDERATIONS

The *bulb* becomes hot during operation. To insure adequate cooling, therefore, it is essential that free circulation of air be provided around the 7027-A.

7027-A



7027-A

BEAM POWER TUBE

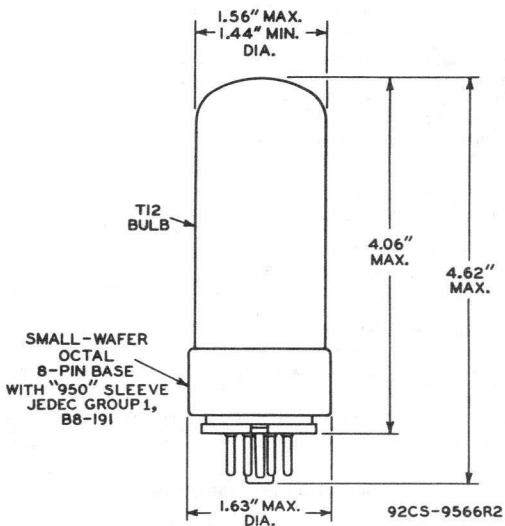



7027-A

7027-A

AVERAGE PLATE CHARACTERISTICS

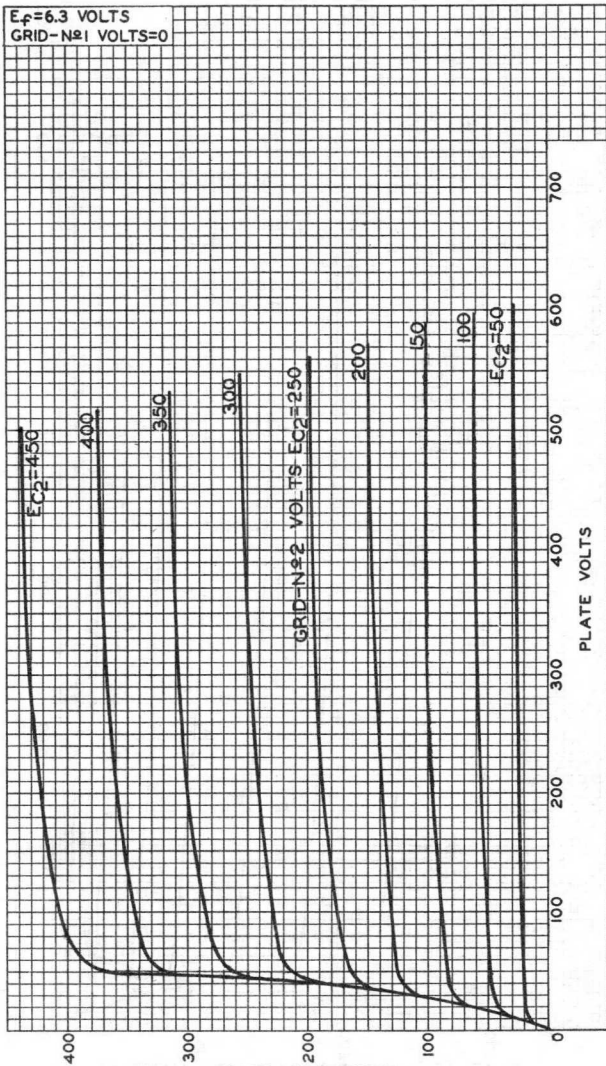

PLATE MILLIAMPERES

ELECTRON TUBE DIVISION

RADIO CORPORATION OF AMERICA, HARRISON, NEW JERSEY

92CM-10132

7027-A



7027-A

AVERAGE CHARACTERISTICS

$E_f = 6.3$ VOLTS
GRID-N \approx 2 VOLTS = 300

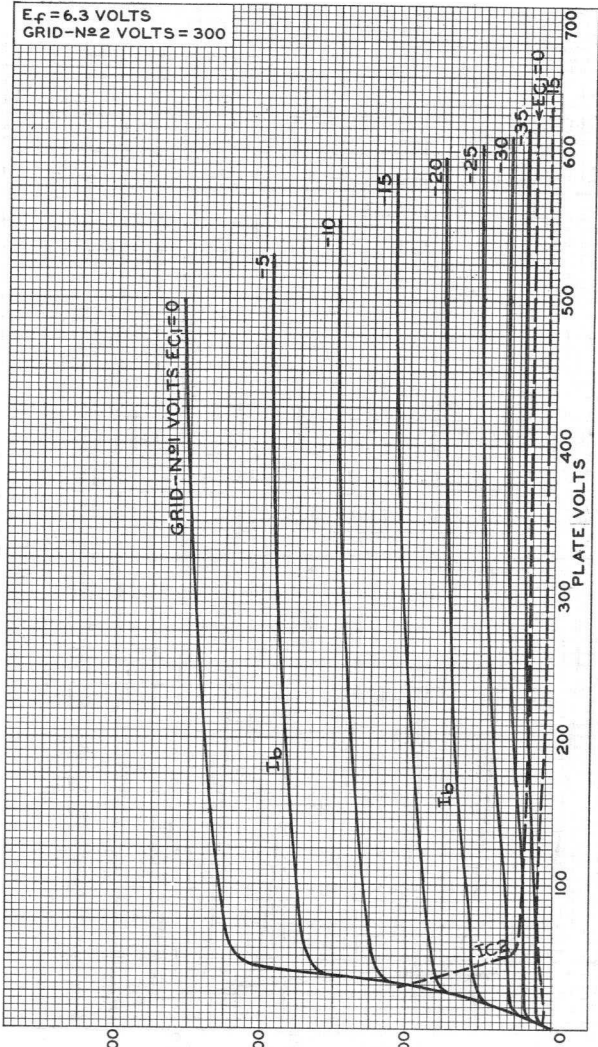

PLATE (I_b) OR GRID-N \approx 2 (I_{c2}) MILLIAMPERES

ELECTRON TUBE DIVISION

92CM-10133

RADIO CORPORATION OF AMERICA, HARRISON, NEW JERSEY



7027-A

7027-A

AVERAGE CHARACTERISTICS

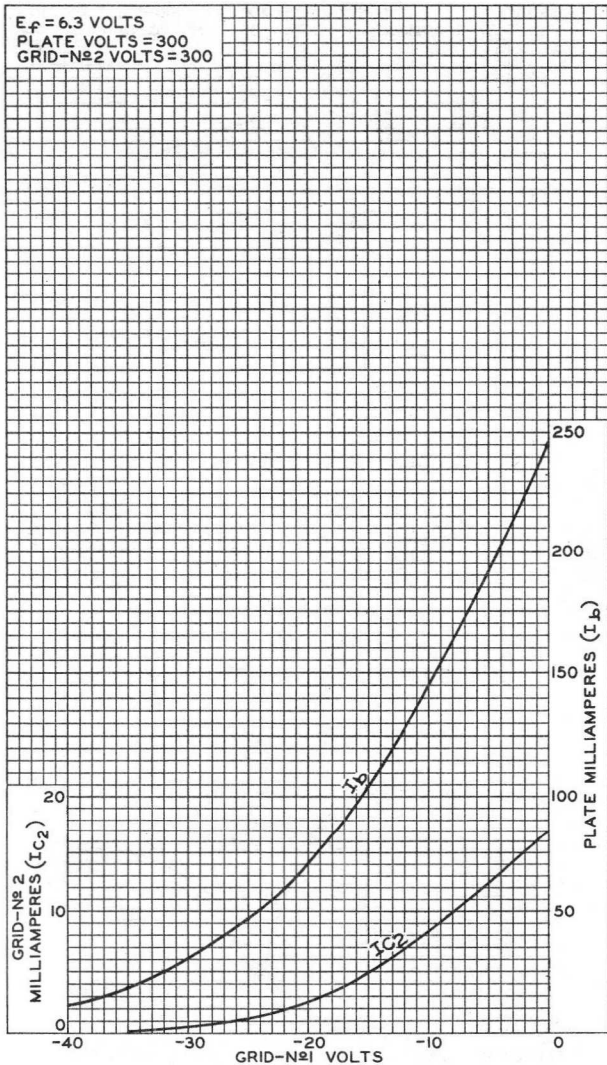

7027-A



7027-A

OPERATION CHARACTERISTICS PUSH-PULL CLASS AB₁

$E_f = 6.3$ VOLTS
PLATE VOLTS = 540

GRID-N^o2 VOLTS = 400
GRID-N^o1 VOLTS = -38

AF GRID-N^o1-TO-GRID-N^o1 VOLTS (RMS) = 53.7

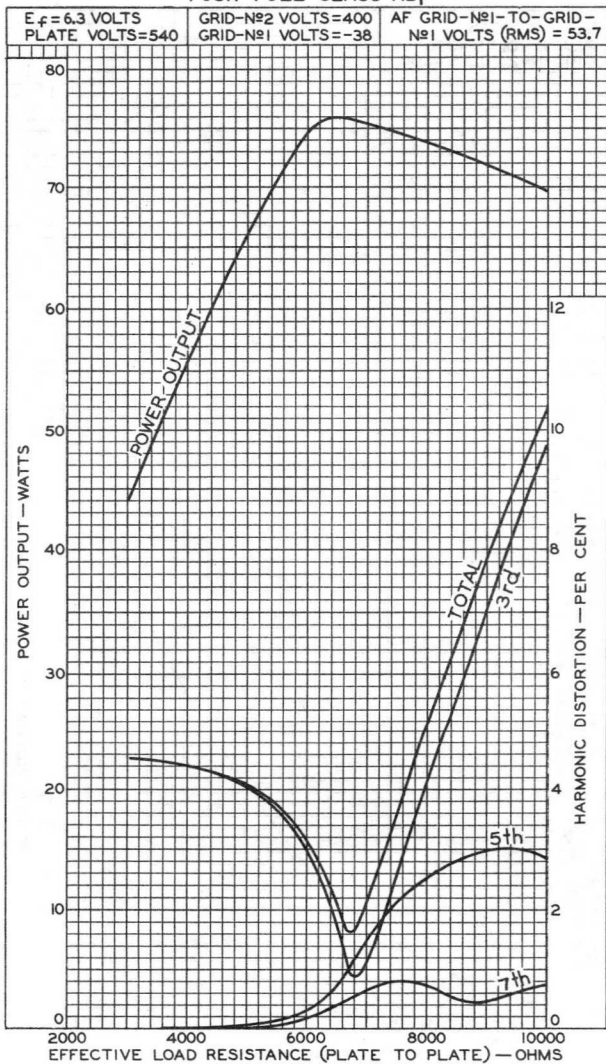

ELECTRON TUBE DIVISION

RADIO CORPORATION OF AMERICA, HARRISON, NEW JERSEY

92CM-10128



7027-A

7027-A

AVERAGE PLATE CHARACTERISTICS TRIODE CONNECTION

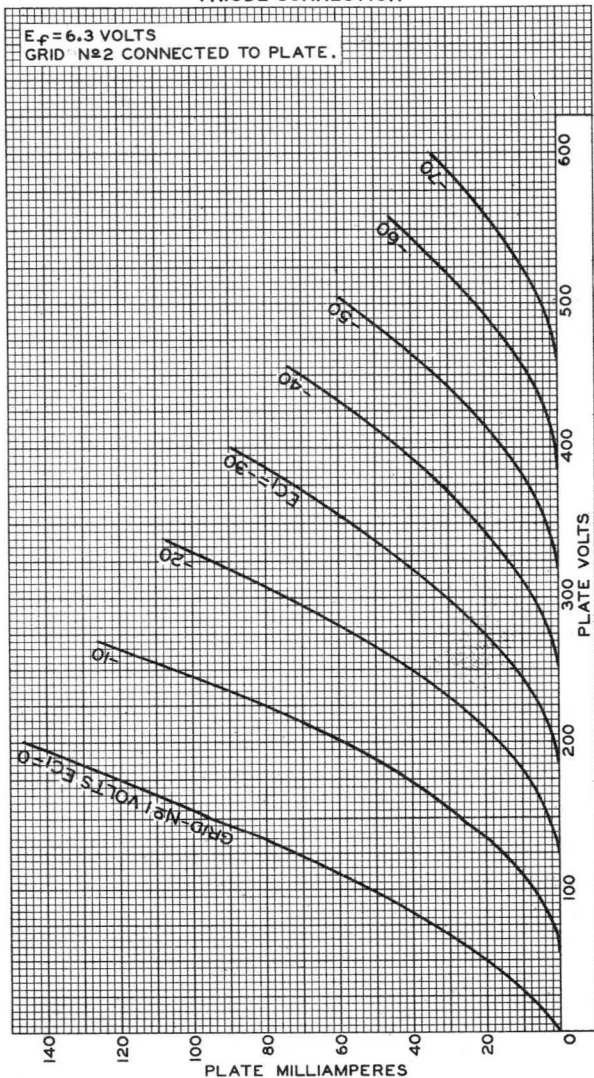

ELECTRON TUBE DIVISION

92CM-9568

RADIO CORPORATION OF AMERICA, HARRISON, NEW JERSEY





7189

7189

POWER PENTODE

9-PIN MINIATURE TYPE

GENERAL DATA

Electrical:

Heater, for Unipotential Cathode:

Voltage (AC or DC)	6.3	volts
Current	0.76	amp

Direct Interelectrode Capacitances (Approx.):^o

Grid No.1 to plate	0.5	μf
Grid No.1 to cathode & grid No.3, grid No.2, and heater	10.8	μf
Plate to cathode & grid No.3, grid No.2, and heater	6.5	μf
Grid No.1 to heater	0.25	μf

Characteristics, Class A₁ Amplifier:

Plate Voltage	250	volts
Grid-No.2 Voltage	250	volts
Grid-No.1 Voltage	-7.3	volts
Mu-Factor, Grid No.2 to Grid No.1	19.5	
Plate Resistance (Approx.)	40000	ohms
Transconductance	11300	μmhos
Plate Current	48	ma
Grid-No.2 Current	5.5	ma

Mechanical:

Operating Position	Any
Maximum Overall Length	3-1/16"
Maximum Seated Length	2-13/16"
Length, Base Seat to Bulb Top (Excluding tip)	2-7/16" \pm 3/32"
Diameter0.750" to 0.875"
Dimensional Outline	See General Section
Bulb	T6-1/2
Base	Small-Button Noval 9-Pin (JEDEC No.E9-1)
Basing Designation for BOTTOM VIEW	9CV

- Pin 1 - Internal Connection - Do Not Use
- Pin 2 - Grid No.1
- Pin 3 - Cathode, Grid No.3

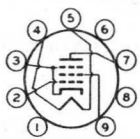

- Pin 4 - Heater
- Pin 5 - Heater
- Pin 6 - Same as Pin 1
- Pin 7 - Plate
- Pin 8 - Same as Pin 1
- Pin 9 - Grid No.2

PUSH-PULL AF POWER AMPLIFIER — Class AB₁

Maximum Ratings, Design-Center Values:

PLATE VOLTAGE	400 max.	volts
GRID-No.2 VOLTAGE	300 max.	volts
CATHODE CURRENT	65 max.	ma
PLATE DISSIPATION	12 max.	watts
ZERO-SIGNAL GRID-No.2 INPUT	2 max.	watts
MAX.-SIGNAL GRID-No.2 INPUT	4 max.	watts



POWER PENTODE

PEAK HEATER-CATHODE VOLTAGE:

Heater negative with respect to cathode.	100 max.	volts
Heater positive with respect to cathode.	100 max.	volts

Typical Operation:

Values are for 2 tubes

Plate Voltage.	400	volts
Grid-No.2 Voltage.	300	volts
Grid-No.1 Voltage.	-15	volts
Peak AF Grid-No.1 Voltage.	14.8	volts
Zero-Signal Plate Current.	15	ma
Max.-Signal Plate Current.	105	ma
Zero-Signal Grid-No.2 Current.	1.6	ma
Max.-Signal Grid-No.2 Current.	25	ma
Effect Load Resistance (Plate to plate)	8000	ohms
Total Harmonic Distortion.	4	%
Max.-Signal Power Output	24	watts

Maximum Circuit Values:

Grid-No.1-Circuit Resistance:

For fixed-bias operation	0.3 max.	megohm
------------------------------------	----------	--------

PUSH-PULL AF POWER AMPLIFIER — Class AB₁

*Grid No.2 of each tube connected to tap
on plate winding of output transformer*

Maximum Ratings, Design-Center Values:

PLATE VOLTAGE	375 max.	volts
CATHODE CURRENT	65 max.	ma
PLATE DISSIPATION	12 max.	watts
ZERO-SIGNAL GRID-No.2 INPUT	2 max.	watts
MAX.-SIGNAL GRID-No.2 INPUT	4 max.	watts
PEAK HEATER-CATHODE VOLTAGE:		
Heater negative with respect to cathode.	100 max.	volts
Heater positive with respect to cathode.	100 max.	volts

Typical Operation:

Values are for 2 tubes

Plate Supply Voltage.	375	volts
Grid-No.2 Supply Voltage.	220	ohms
Cathode Resistor.	220	ohms
Peak AF Grid-No.1 Voltage	17.7	volts
Zero-Signal Plate Current	70	ma
Max.-Signal Plate Current	81	ma
Effective Load Resistance (Plate to plate).	11000	ohms
Total Harmonic Distortion	3	%
Max.-Signal Power Output.	16.5	watts



7189

7189

POWER PENTODE

Maximum Circuit Values:

Grid-No.1-Circuit Resistance:

For cathode-bias operation. 1 max. megohm

○ Without external shield.

◆ Obtained from taps on the primary winding of the output transformer. The taps are located on each side of the center-tap (B+) so as to supply 43 per cent of the plate signal voltage to grid No.2 of each output tube.



7199

7199

MEDIUM-MU TRIODE— SHARP-CUTOFF PENTODE

9-PIN MINIATURE TYPE

For high-fidelity audio-amplifier applications critical as to noise and hum

GENERAL DATA

Electrical:

Heater, for Unipotential Cathodes:

Voltage $6.3 \pm 10\%$ ac or dc volts

Current 0.45 amp

Direct Interelectrode Capacitances:⁰

Triode Unit:

Grid to plate 2 $\mu\mu\text{f}$ Grid to cathode and heater 2.3 $\mu\mu\text{f}$ Plate to cathode and heater 0.3 $\mu\mu\text{f}$

Pentode Unit:

Grid No.1 to plate 0.06 max. $\mu\mu\text{f}$ Grid No.1 to cathode & internal shield & grid No.3, grid No.2, and heater 5 $\mu\mu\text{f}$ Plate to cathode & internal shield & grid No.3, grid No.2, and heater 2 $\mu\mu\text{f}$

Equivalent-Hum and Noise Voltage (Referenced to Grid):

Triode Unit

Median Value (RMS) 10 microvolts

Maximum Value (RMS). 150 microvolts

Measured in "true rms" units under the following conditions:
heater volts = 6.3 ac, center-tap of heater transformer connected to ground, plate-supply volts = 250, plate load resistor (megohms) = 0.1, cathode resistor (ohms) = 1500, grid resistor (megohms) = 0.05, and amplifier covering frequency range between 25 and 10,000 cps.

Pentode Unit

Median Value (RMS) 35 microvolts

Maximum Value (RMS). 100 microvolts

Measured in "true rms" units under the following conditions:
heater volts = 6.3 ac, center-tap of heater transformer connected to ground, plate-supply volts = 250, plate-load resistor (megohms) = 0.1, grid-No.2 supply volts = 250, grid-No.2 resistor (megohms) = 0.33, grid-No.2-bypass capacitor (μf) = 0.22, cathode resistor (ohms) = 1200, grid-No.1 resistor (megohms) = 0.05, and amplifier covering frequency range between 25 and 10,000 cps.

Characteristics, Class A₁ Amplifier:

	Triode Unit	Pentode Unit	
Plate-Supply Voltage	215	100 220	volts

⁰: See next page.



7199

MEDIUM-MU TRIODE— SHARP-CUTOFF PENTODE

	Triode Unit	Pentode Unit		
Grid-No.2 Supply voltage	-	50	130	volts
Grid-No.1 Voltage.	-8.5	-	-	volts
Cathode Resistor	-	1000	62	ohms
Amplification Factor	17	-	-	
Plate Resistance (Approx.)	0.0081	1	0.4	megohm
Transconductance	2100	1500	7000	μ mhos
Plate Current.	9	1.1	12.5	ma
Grid-No.2 Current.	-	0.35	3.5	ma
Grid-No.1 Voltage (Approx.) for plate μ a = 10.	-40	-4	-	volts

Mechanical:

Operating Position	Any
Maximum Overall Length	2-3/16"
Maximum Seated Length.	1-15/16"
Length, Base Seat to Bulb Top (Excluding tip).	1-9/16" \pm 3/32"
Diameter	0.750" to 0.875"
Dimensional Outline.	See General Section
Bulb	T6-1/2
Base	Small-Button Noval 9-Pin (JEDEC No. E9-1)
Basing Designation for BOTTOM VIEW9JT

Pin 1—Triode
Plate
Pin 2—Pentode
Plate
Pin 3—Pentode
Grid No.2
Pin 4—Heater
Pin 5—Heater

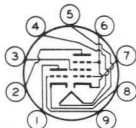

Pin 6—Pentode
Cathode,
Grid No.3,
Internal
Shield
Pin 7—Pentode
Grid No.1
Pin 8—Triode
Cathode
Pin 9—Triode
Grid

AMPLIFIER — Class A₁

Maximum Ratings, Design-Maximum Values:

	Triode Unit	Pentode Unit	
PLATE VOLTAGE.	330 max.	330 max.	volts
GRID-No.2 (SCREEN-GRID) SUPPLY VOLTAGE	-	330 max.	volts
GRID-No.2 VOLTAGE.	-	See Grid-No.2 Input	
<i>Rating Chart at front of Receiving Tube Section</i>			
GRID-No.1 (CONTROL-GRID) VOLTAGE: Positive-bias value.	0 max.	0 max.	volts

o: See next page.

Medium-Mu Triode— Sharp-Cutoff Pentode

9-PIN MINIATURE TYPE

For High-Fidelity Audio-Amplifier Ap-
plications Critical as to Noise and Hum

GENERAL DATA

Electrical:

Heater Characteristics and Ratings:

Voltage (AC or DC)	6.3 ± 0.6	volts
Current at heater volts = 6.3	0.450	amp
Peak heater-cathode voltage (Each Unit):		
Heater negative with respect to cathode	200	max. volts
Heater positive with respect to cathode	200 ^a	max. volts

Direct Interelectrode Capacitances:^b*Triode Unit:*

Grid to plate	2	pf
Grid to cathode and heater	2.3	pf
Plate to cathode and heater	0.3	pf

Pentode Unit:

Grid No.1 to plate	0.06	max. pf
Grid No.1 to cathode & internal shield & grid No.3, grid No.2, and heater	5	pf
Plate to cathode & internal shield & grid No.3, grid No.2, and heater	2	pf

Equivalent-Hum and Noise Voltage (Referenced to Grid): ←

Triode Unit

Average Value (RMS)	10	microvolts
Maximum Value (RMS)	50	microvolts

Measured in "true rms" units under the following conditions: heater volts = 6.3 ac, center-tap of heater transformer connected to ground, plate-supply volts = 250, plate load resistor (megohms) = 0.1, cathode resistor (ohms) unbypassed = 1500, grid resistor (megohms) = 0.05, and amplifier covering frequency range between 25 and 10,000 cps.

Pentode Unit

Average Value (RMS)	15	microvolts
Maximum Value (RMS)	35	microvolts

Measured in "true rms" units under the following conditions: heater volts = 6.3 ac, center-tap of heater transformer connected to ground, plate-supply volts = 250, plate-load resistor (megohms) = 0.22, grid-No.2 supply volts = 250; grid No.2 voltage divider: resistor (megohm) from grid No.2 to B+ = 0.68, resistor (megohm) from grid-No.2 to ground = 0.33; bypass ca-

← Indicates a change.



pacitor (μf) from grid No.2 to cathode = 0.1; cathode resistor (ohms unbypassed) = 680; grid No.1 resistor (megohm) = 0.27; and amplifier covering frequency range between 25 and 10,000 cps.

Characteristics, Class A₁ Amplifier:

	Triode Unit	Pentode Unit		
Plate-Supply Voltage	215	100	220	volts
Grid-No.2 Supply Voltage	-	50	130	volts
Grid-No.1 Voltage	-8.5	-	-	volts
Cathode Resistor	-	1000	62	ohms
Amplification Factor	17	-	-	
Plate Resistance (Approx.)	0.0081	1	0.4	megohm
Transconductance	2100	1500	7000	μ mhos
Plate Current	9	1.1	12.5	ma
Grid-No.2 Current	-	0.35	3.5	ma
Grid-No.1 Voltage (Approx.) for plate $\mu a = 10$	-40	-4	-	volts

Mechanical:

Operating Position Any
 Type of Cathodes Coated Unipotential
 Maximum Overall Length 2-3/16"
 Maximum Seated Length 1-15/16"
 Length, Base Seat to Bulb Top (Excluding tip) 1-9/16" \pm 3/32"
 Diameter 0.750" to 0.875"
 Dimensional Outline See *General Section*
 Bulb T6-1/2
 Base Small-Button Noval 9-Pin (JEDEC No. E9-1)
 Basing Designation for BOTTOM VIEW 9JT

Pin 1 - Triode
 Plate
 Pin 2 - Pentode
 Plate
 Pin 3 - Pentode
 Grid No. 2
 Pin 4 - Heater
 Pin 5 - Heater

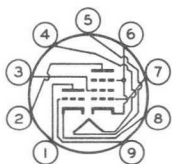

Pin 6 - Pentode
 Cathode,
 Grid No. 3,
 Internal
 Shield
 Pin 7 - Pentode
 Grid No. 1
 Pin 8 - Triode
 Cathode
 Pin 9 - Triode
 Grid

AMPLIFIER — Class A₁

Maximum Ratings, Design-Maximum Values:

	Triode Unit	Pentode Unit	
PLATE VOLTAGE	330 max.	330 max.	volts
GRID-No.2 (SCREEN-GRID) SUPPLY VOLTAGE	-	330 max.	volts
GRID-No.2 VOLTAGE	-	See <i>Grid-No.2 Input</i>	
<i>Rating Chart at front of Receiving Tube Section</i>			
GRID-No.1 (CONTROL-GRID) VOLTAGE: Positive-bias value	0 max.	0 max.	volts



	<i>Triode Unit</i>	<i>Pentode Unit</i>	
GRID-No.2 INPUT:			
For grid-No.2 voltages up to 165 volts	-	0.6 max.	watt
For grid-No.2 voltages between 165 and 330 volts	-	See <i>Grid-No.2 Input Rating Chart</i> at front of Receiving Tube Section	
PLATE DISSIPATION	2.4 max.	3 max.	watts

Maximum Circuit Values:

	<i>Triode Unit</i>	<i>Pentode Unit</i>	
Grid-No.1-Circuit Resistance: ^c			
For fixed-bias operation	0.5 max.	0.25 max.	megohm
For cathode-bias operation	1 max.	1 max.	megohm

- ^a The dc component must not exceed 100 volts.
- ^b Without external shield.
- ^c If either unit is operated at maximum rated conditions, grid-No.1-circuit resistances for both units should not exceed the stated values.



AVERAGE PLATE CHARACTERISTICS

Triode Unit

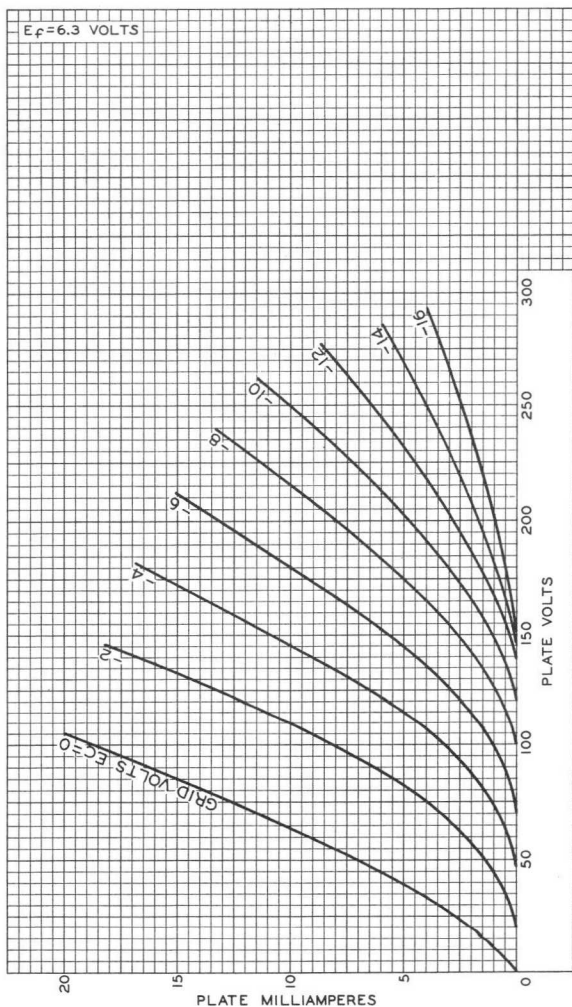

92CM-9693





7199

7199

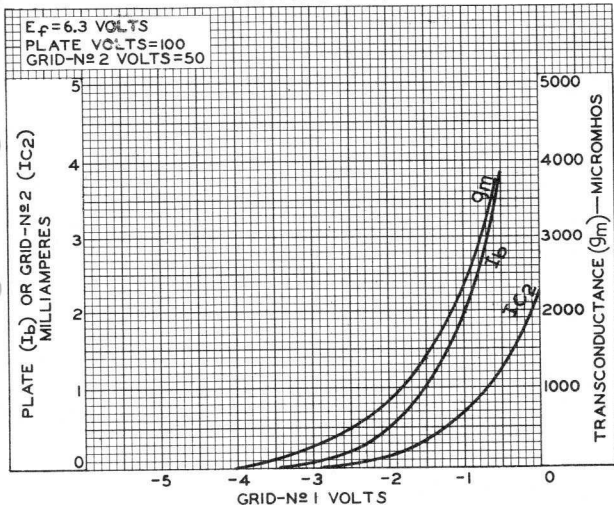
AVERAGE CHARACTERISTICS
PENTODE UNIT

92CS-9702

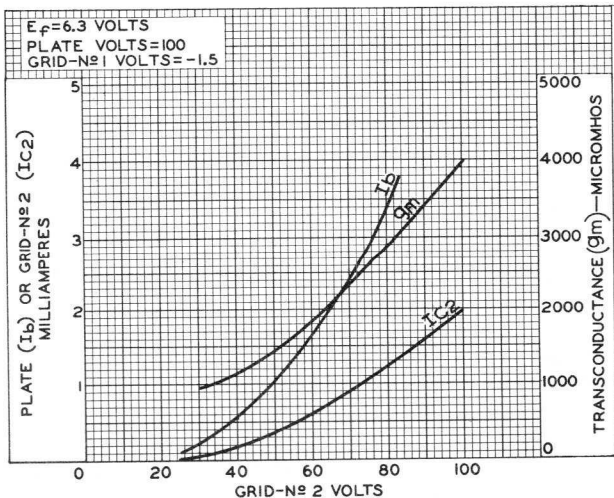

ELECTRON TUBE DIVISION

RADIO CORPORATION OF AMERICA, HARRISON, NEW JERSEY

92CS-9703

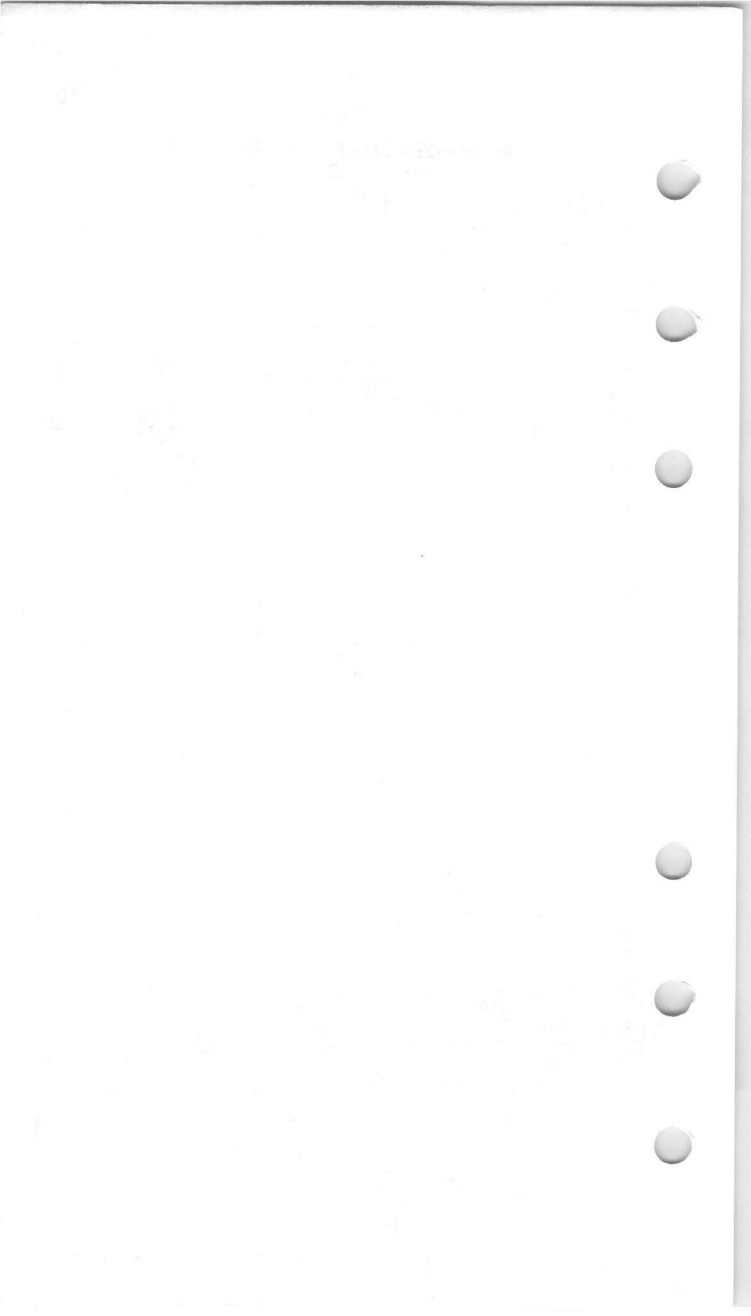

Beam Power Tube

GENERAL DATA

Electrical:

Heater Characteristics and Ratings (<i>Design-Maximum Values</i>):		
Voltage (AC or DC)	6.3 ± 0.6	volts
Current at heater volts = 6.3	0.450	amp
Peak heater-cathode voltage:		
Heater negative with respect to cathode	200	max. volts
Heater positive with respect to cathode	200 ^a	max. volts
Direct Interelectrode Capacitances (Approx.): ^b		
Grid No.1 to plate	0.7	μf
Grid No.1 to cathode & grid No.3, grid No.2, and heater	9	μf
Plate to cathode & grid No.3, grid No.2, and heater	7.5	μf

Mechanical:

Operating Position	Any
Type of Cathode	Coated Unipotential
Maximum Overall Length	3-5/16"
Maximum Seated Length	2-3/4"
Maximum Diameter	1-9/32"
Dimensional Outline	See <i>General Section</i>
Bulb	T9

Bases (Alternates):

Intermediate-Shell Octal:

7-Pin, Arrangement 1 (JEDEC Group 1, No.B7-7)

Short Intermediate-Shell Octal with External Barriers:

7-Pin, Arrangement 1 (JEDEC Group 1, No.B7-59)

Basing Designation for BOTTOM VIEW 7S

Pin 1 - No Internal
Connection
Pin 2 - Heater
Pin 3 - Plate
Pin 4 - Grid No.2

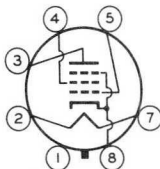

Pin 5 - Grid No.1
Pin 7 - Heater
Pin 8 - Cathode,
Grid No.3

AF POWER AMPLIFIER — Class A₁Maximum Ratings, *Design-Maximum Values*:

PLATE VOLTAGE	350	max.	volts
GRID-No.2 (SCREEN-GRID) VOLTAGE	315	max.	volts
GRID-No.2 INPUT	2.2	max.	watts
PLATE DISSIPATION	14	max.	watts

Typical Operation and Characteristics:

Plate Voltage	60	250	volts
Grid-No.2 Voltage	250	250	volts
Grid-No.1 (Control-Grid) Voltage	0	-12.5	volts
Peak AF Grid-No.1 Voltage	-	12.5	volts



7408

Zero-Signal Plate Current	100 ^c	45	ma
Max.-Signal Plate Current	-	47	ma
Zero-Signal Grid-No.2 Current	22 ^c	4.5	ma
Max.-Signal Grid-No.2 Current	-	7	ma
Plate Resistance (Approx.)	-	50000	ohms
Transconductance	-	4100	μ mhos
Load Resistance	-	5000	ohms
Total Harmonic Distortion	-	7	%
Max.-Signal Power Output	-	4.5	watts

Maximum Circuit Values:

Grid-No.1-Circuit Resistance:

For fixed-bias operation	0.1 max.	megohm
For cathode-bias operation	0.5 max.	megohm

^a The dc component must not exceed 100 volts.

^b without external shield.

^c This value can be measured by a method involving a recurrent wave form such that the maximum ratings of the tube will not be exceeded.



Sharp-Cutoff Pentode

7-PIN MINIATURE TYPE

For High-Gain, Resistance-Coupled-Amplifier Applications Critical as to Hum and Microphonism

GENERAL DATA

Electrical:

Heater, for Unipotential Cathode:

Voltage (AC or DC) 6.3 volts
Current 0.3 amp

Direct Interelectrode Capacitances:

	Without External Shield	With External Shield [▲]	
<i>Pentode Connection:</i>			
Grid No.1 to plate . . .	0.0035 max.	0.0035 max.	$\mu\mu\text{f}$
Grid No.1 to cathode, grid No.3 & internal shield, grid No.2, and heater .	5.5	5.5	$\mu\mu\text{f}$
Plate to cathode, grid No.3 & internal shield, grid No.2, and heater .	5	5	$\mu\mu\text{f}$
<i>Triode Connection:</i>			
Grid No.1 to plate, grid No.3 & internal shield, and grid No.2	2.6	2.6	$\mu\mu\text{f}$
Grid No.1 to cathode and heater	3.2	3.2	$\mu\mu\text{f}$
Plate, grid No.3 & internal shield, and grid No.2 to cathode and heater	1.2	8.5	$\mu\mu\text{f}$

Hum Output Voltage:

Average Value (RMS, Cathode Bypassed) 1.2 millivolts
Measured in "true rms" units under the following conditions:
heater volts = 6.3; center-tap of heater transformer connected to ground; plate and grid-No.2 supply volts = 250; plate load resistor (megohms) = 0.27; grid No.3 and internal shield connected to cathode at socket; grid-No.2 resistor (megohms) = 0.68; grid-No.1 resistor (megohms) = 0.1; cathode resistor (ohms) = 1000; grid resistor of following stage (megohms) = 10; and stage gain of 340.

Average Value (RMS, Cathode Unbypassed) . . . 0.9 millivolt
Measured in "true rms" units under the same conditions as for "Average Value" except that the cathode resistor is unbypassed, and the stage gain is 110.

Characteristics, Class A₁ Amplifier:*Pentode Connection*

Plate Supply Voltage 100 250 250 volts
Grid No.3 & Internal Shield Connected to cathode at socket



Grid-No.2 Supply Voltage.	100	125	150	volts
Cathode Resistor.	150	100	68	ohms
Plate Resistance (Approx.).	0.5	1.5	1	megohms
Transconductance.	3900	4500	5200	μ mhos
Plate Current	5	7.6	10.6	ma
Grid-No.2 Current	2.1	3	4.3	ma
Grid-No.1 Voltage (Approx.) for plate μ a = 10	-4.2	-5.5	-6.5	volts

Triode Connection

Plate Supply Voltage.	250	volts
Cathode Resistor.	330	ohms
Amplification Factor.	36	
Plate Resistance (Approx.).	7500	ohms
Transconductance.	4800	μ mhos
Plate Current	12.2	ma

Mechanical:

Operating Position.	Any
Maximum Overall Length.	2-1/8"
Maximum Seated Length	1-7/8"
Length, Base Seat to Bulb Top (Excluding tip).	1-1/2" \pm 3/32"
Diameter.	0.650" to 0.750"
Dimensional Outline	See <i>General Section</i>
Bulb.	T5-1/2
Base.	Small-Button Miniature 7-Pin (JEDEC No.E7-1)
Basing Designation for BOTTOM VIEW.	7BK

- Pin 1 - Grid No.1
- Pin 2 - Grid No.3,
Internal
Shield
- Pin 3 - Heater

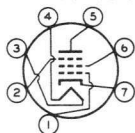

- Pin 4 - Heater
- Pin 5 - Plate
- Pin 6 - Grid No.2
- Pin 7 - Cathode

AMPLIFIER — Class A₁

Maximum Ratings, Design-Center Values:

	Triode Connection	Pentode Connection
PLATE VOLTAGE	250 max.	300 max. volts
GRID No.3 (SUPPRESSOR GRID)	-	Connect to cathode at socket
GRID-No.2 (SCREEN-GRID) SUPPLY VOLTAGE.	-	300 max. volts
GRID-No.2 VOLTAGE	-	See Grid-No.2 Input Rating Chart at front of Receiving Tube Section
GRID-No.1 (CONTROL-GRID) VOLTAGE:		
Positive-bias value	0 max.	0 max. volts
GRID-No.2 INPUT:		
For grid-No.2 voltages up to 150 volts	-	0.65 max. watt
For grid-No.2 voltages be- tween 150 and 300 volts	-	See Grid-No.2 Input Rating Chart at front of Receiving Tube Section



PLATE DISSIPATION.	3.2 max.	3 max.	watts
PEAK HEATER-CATHODE VOLTAGE:			
Heater negative with respect to cathode	200 max.	200 max.	volts
Heater positive with respect to cathode	200* max.	200* max.	volts

Typical Operation as Resistance-Coupled Amplifier:

See *RESISTANCE-COUPLED-AMPLIFIER CHART No. 8*
at front of this Section

- ▲ With external shield JEDEC No. 316 connected to cathode.
- Grid No. 3 & internal shield and grid No. 2 connected to plate.
- ★ The dc component must not exceed 100 volts.

CURVES

For the 7543, within its ratings, are the same
as those shown for Type 6AU6







7551

7551

BEAM POWER TUBE

9-PIN MINIATURE TYPE

For use in communications equipment operating from 6-cell storage-battery systems

GENERAL DATA

Electrical:

Heater, for Unipotential Cathode:

Voltage range.	12 to 15	volts
Current at 13.5 volts.	0.36	amp

Direct Interelectrode Capacitances:^o

Grid No.1 to plate	0.15 max.	$\mu\mu\text{f}$
Grid No.1 to cathode, grid No.3, grid No.2, and heater.	10	$\mu\mu\text{f}$
Plate to cathode, grid No.3, grid No.2, and heater.	5.5	$\mu\mu\text{f}$

Characteristics, Class A₁ Amplifier:

Heater Voltage	13.5	volts
Plate Voltage.	250	volts
Grid No.3.	<i>Connected to cathode at socket</i>	
Grid-No.2 Voltage.	250	volts
Grid-No.1 Voltage.	-18	volts
Mu-Factor, Grid No.2 to Grid No.1.	8.7	
Transconductance	5300	μmhos
Plate Current.	40	ma
Grid-No.2 Current.	3	ma

Mechanical:

Operating Position	Any
Maximum Overall Length	2-5/8"
Maximum Seated Length.	2-3/8"
Length, Base Seat to Bulb Top (Excluding tip).	2" \pm 3/32"
Diameter	0.750" to 0.875"
Dimensional Outline.	<i>See General Section</i>
Bulb	T6-1/2
Base	Small-Button Noval 9-Pin (JEDEC No.E9-1)
Basing Designation for BOTTOM VIEW9LK

- Pin 1 - Cathode
- Pin 2 - Grid No.1
- Pin 3 - Grid No.2
- Pin 4 - Heater
- Pin 5 - Heater

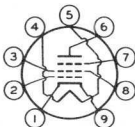

- Pin 6 - Plate
- Pin 7 - Grid No.3
- Pin 8 - Grid No.2
- Pin 9 - Cathode

AF POWER AMPLIFIER & MODULATOR — Class AB₁

Maximum CCS^o Ratings, Absolute-Maximum Values:

DC PLATE VOLTAGE	300 max.	volts
GRID No.3 (SUPPRESSOR GRID).	<i>Connect to cathode at socket</i>	
DC GRID-No.2 (SCREEN-GRID) VOLTAGE	250 max.	volts
MAX.-SIGNAL DC PLATE CURRENT [■]	70 max.	ma
MAX.-SIGNAL PLATE INPUT [■]	21 max.	watts
MAX.-SIGNAL GRID-No.2 INPUT [■]	2 max.	watts

7551



7551

BEAM POWER TUBE

PLATE DISSIPATION [■]	10 max.	watts
PEAK HEATER-CATHODE VOLTAGE:		
Heater negative with respect to cathode	100 max.	volts
Heater positive with respect to cathode	100 max.	volts
BULB TEMPERATURE (At hottest point on bulb surface).		
	225 max.	°C

Typical CCS Push-Pull Operation:

Values are for 2 tubes

Heater Voltage.	13.5	volts
DC Plate Voltage.	300	volts
Grid No.3	<i>Connected to cathode at socket</i>	
DC Grid-No.2 Voltage§	250	volts
DC Grid-No.1 Voltage§	-21	volts
Peak AF Grid-No.1-to-Grid-No.1 Voltage.	40	volts
Zero-Signal DC Plate Current.	40	ma
Max.-Signal DC Plate Current.	125	ma
Zero-Signal DC Grid-No.2 Current.	2	ma
Max.-Signal DC Grid-No.2 Current.	14	ma
Effective Load Resistance (Plate to plate).	5000	ohms
Max.-Signal Driving Power	0	watts
Total Harmonic Distortion	5	%
Max.-Signal Power Output (Approx.).	20.5	watts

Maximum Circuit Values:

Grid-No.1-Circuit Resistance.	0.1 max.	megohm
---------------------------------------	----------	--------

RF POWER AMPLIFIER & OSCILLATOR — Class C Telegraphy† and RF POWER AMPLIFIER — Class C FM Telephony

Maximum Ratings, Absolute-Maximum Values:

	<i>Up to 175 Mc</i>	
	CCS [•]	ICAS ^{••}
DC PLATE VOLTAGE.	300 max.	300 max.
GRID No.3 (SUPPRESSOR GRID)	<i>Connect to cathode at socket</i>	
DC GRID-No.2 (SCREEN-GRID) VOLTAGE	250 max.	250 max.
DC GRID-No.1 (CONTROL-GRID) VOLTAGE	-125 max.	-125 max.
DC PLATE CURRENT.	70 max.	80 max.
DC GRID-No.2 CURRENT.	15 max.	15 max.
DC GRID-No.1 CURRENT.	5 max.	5 max.
PLATE INPUT	21 max.	24 max.
GRID-No.2 INPUT	2 max.	2 max.
PLATE DISSIPATION	10 max.	12 max.
PEAK HEATER-CATHODE VOLTAGE:		
Heater negative with respect to cathode.	100 max.	100 max.
Heater positive with respect to cathode.	100 max.	100 max.



7551

7551

BEAM POWER TUBE

BULB TEMPERATURE (At hottest point on bulb surface). 225 max. 225 max. °C

Typical Operation:

As amplifier at 175 Mc

	CCS*	ICAS**	
Heater Voltage.	13.5	13.5	13.5 volts
DC Plate Voltage.	250	300	300 volts
Grid No.3	Connected to cathode at socket		
DC Grid-No.2 Voltage ^{□□}	200	200	250 volts
DC Grid-No.1 Voltage ^{⊕⊕}	-40	-42	-55 volts
Peak RF Grid-No.1 Voltage	47	52	62 volts
DC Plate Current.	60	70	80 ma
DC Grid-No.2 Current.	3.7	3.7	5.1 ma
DC Grid-No.1 Current (Approx.).	1.5	2.1	1.6 ma
Driver Power Output (Approx.) ^{▲▲}	1	1	1.5 watts
Useful Power Output (Approx.) [*]	6.5	8.5	10 watts

Maximum Circuit Values:

Grid-No.1-Circuit Resistance. 0.1 max. 0.1 max. megohm

PLATE-MODULATED RF POWER AMPLIFIER — Class C Telephony

Carrier conditions per tube for use with a maximum modulation factor of 1

Maximum Ratings, Absolute-Maximum Values:

	Up to 175 Mc		
	CCS*	ICAS**	
DC PLATE VOLTAGE.	250 max.	250 max.	volts
GRID No.3 (SUPPRESSOR GRID)	Connect to cathode at socket		
DC GRID-No.2 (SCREEN-GRID) VOLTAGE	250 max.	250 max.	volts
DC GRID-No.1 (CONTROL-GRID) VOLTAGE	125 max.	125 max.	volts
DC PLATE CURRENT.	60 max.	70 max.	ma
DC GRID-No.2 CURRENT.	10 max.	10 max.	ma
DC GRID-No.1 CURRENT.	5 max.	5 max.	ma
PLATE INPUT	15 max.	17.5 max.	watts
GRID-No.2 INPUT	1.4 max.	1.4 max.	watts
PLATE DISSIPATION	7 max.	8 max.	watts
PEAK HEATER-CATHODE VOLTAGE:			
Heater negative with respect to cathode.	100 max.	100 max.	volts
Heater positive with respect to cathode.	100 max.	100 max.	volts
BULB TEMPERATURE (At hottest point on bulb surface).	225 max.	225 max.	°C

7551



7551

BEAM POWER TUBE

	CCS*	ICAS**	
Typical Operation:			
	<i>At 175 Mc</i>		
Heater Voltage.	13.5	13.5	volts
DC Plate Voltage.	250	250	volts
Grid No.3	<i>Connected to cathode at socket</i>		
DC Grid-No.2 Voltage [▲]	250	250	volts
DC Grid-No.1 Voltage [★]	-70	-75	volts
From a grid-No.1 resistor of	33000	33000	ohms
RF Grid-No.1 Voltage.	75	80	volts
DC Plate Current.	60	70	ma
DC Grid-No.2 Current.	2.5	3	ma
DC Grid-No.1 Current (Approx.)	2.1	2.3	ma
Driving Power (Approx.) ^{▲▲}	1	1	watt
Useful Power Output*.	6.5	7.5	watts
Maximum Circuit Values:			
Grid-No.1-Circuit Resistance.	0.1 max.	0.1 max.	megohm

FREQUENCY MULTIPLIER

Maximum Ratings, Absolute-Maximum Values:

	CCS*	ICAS**	
DC PLATE VOLTAGE.	300 max.	300 max.	volts
GRID No.3 (SUPPRESSOR GRID)	<i>Connect to cathode at socket</i>		
DC GRID-No.2 (SCREEN-GRID) VOLTAGE	250 max.	250 max.	volts
DC GRID-No.1 (CONTROL-GRID) VOLTAGE	-125 max.	-125 max.	volts
DC PLATE CURRENT.	50 max.	60 max.	ma
DC GRID-No.2 CURRENT.	15 max.	15 max.	ma
DC GRID-No.1 CURRENT.	5 max.	5 max.	ma
PLATE INPUT	13 max.	15 max.	watts
GRID-No.2 INPUT	2 max.	2 max.	watts
PLATE DISSIPATION	10 max.	12 max.	watts
PEAK HEATER-CATHODE VOLTAGE:			
Heater negative with respect to cathode.	100 max.	100 max.	volts
Heater positive with respect to cathode.	100 max.	100 max.	volts
BULB TEMPERATURE (At hottest point on bulb surface).	225 max.	225 max.	°C

Typical Operation:

	<i>As doubler to 175 Mc</i>		
Heater Voltage.	13.5	13.5	volts
DC Plate Voltage.	250	300	volts
Grid No.3	<i>Connected to cathode at socket</i>		
DC Grid-No.2 Voltage.	200	250	volts



7551

7551

BEAM POWER TUBE

DC Grid-No.1 Voltage [⊕]	-53	-66	volts
From a grid-No.1 resistor of	53000	44000	ohms
Peak RF Grid-No.1 Voltage	60	74	volts
DC Plate Current	50	60	ma
DC Grid-No.2 Current	2.6	3.5	ma
DC Grid-No.1 Current (Approx.)	1	1.5	ma
Driving Power (Approx.) ^{▲▲}	0.4	0.6	watt
Useful Power Output*	3	4.5	watts

As tripler to 175 Mc

Heater Voltage	13.5	13.5	volts
DC Plate Voltage	200	250	volts
Grid No.3	Connected to cathode at socket		
DC Grid-No.2 Voltage	200	250	volts
DC Grid-No.1 Voltage [⊕]	-90	-120	volts
From a grid-No.1 resistor of	50000	70000	ohms
Peak RF Grid-No.1 Voltage	105	130	volts
DC Plate Current	50	60	ma
DC Grid-No.2 Current	3	3.9	ma
DC Grid-No.1 Current (Approx.)	1.85	1.7	ma
Driving Power (Approx.) ^{▲▲}	0.4	0.6	watt
Useful Power Output*	1.4	2.3	watts

Maximum Circuit Values:

Grid-No.1-Circuit Resistance.	0.1 max.	0.1 max.	megohm
-------------------------------	----------	----------	--------

○ Without external shield.

◆ Subscript 1 indicates that grid-No.1 current does not flow during any part of the input cycle.

● Continuous Commercial Service.

■ Averaged over any audio-frequency cycle of sine-wave form.

§ Obtained preferably from a fixed supply.

† Key-down conditions per tube without amplitude modulation. Amplitude modulation essentially negative may be used if the positive peak of the audio-frequency envelope does not exceed 115% of the carrier conditions.

●● Intermittent Commercial and Amateur Service.

□ Obtained preferably from a separate source or from the plate-voltage supply with a voltage divider. If a series resistor is used, it should be adjustable to obtain the desired operating plate current after initial tuning adjustments are completed.

⊕ Obtained from a grid-No.1 resistor or from a combination of grid-No.1 resistor with either fixed supply or cathode resistor.

▲▲ Driver stage is required to supply tube losses and rf-circuit losses. The driver stage should be designed to provide an excess of power above the indicated values to take care of variations in line voltage, components, initial tube characteristics, and tube characteristics during life.

* Measured at load.

▲ Obtained preferably from a separate source modulated along with the plate supply, or from the modulated plate supply through a series resistor. It is recommended that this resistor be adjustable to obtain the desired operating plate current after initial tuning adjustments are made.

7551



7551

BEAM POWER TUBE

- * Obtained from a grid-No.1 resistor or from a combination of grid-No.1 resistor with either fixed supply or cathode resistor. The combination of grid-No.1 resistor and fixed supply has the advantage of not only protecting the tube from damage through loss of excitation but also of minimizing distortion by bias-supply compensation.

CHARACTERISTICS RANGE VALUES FOR EQUIPMENT DESIGN

	Note	Min.	Max.	
Heater Current	1	0.33	0.39	amp
Transconductance	1,2	4200	6400	μ mhos
Plate Current	1,2	30	50	ma
Plate Current	1,3	-	50	μ a
Grid-No.2 Current	1,2	-	7.5	ma
Reverse Grid-No.1 Current	1,4	-	2	μ a
Heater-Cathode Leakage Current:				
Heater negative with respect to cathode	1,5	-	20	μ a
Heater positive with respect to cathode	1,5	-	20	μ a
Leakage Resistance:				
Between grid No.1 and all other electrodes tied together	1,6	100	-	megohms
Between plate and all other electrodes tied together	1,7	100	-	megohms

Note 1: With 13.5 volts ac or dc on heater.

Note 2: With plate voltage of 250 volts, grid No.3 connected to cathode, grid-No.2 voltage of 250 volts, and grid-No.1 voltage of -18 volts.

Note 3: With plate voltage of 250 volts, grid No.3 connected to cathode, grid-No.2 voltage of 250 volts, and grid-No.1 voltage of -48 volts.

Note 4: With plate voltage of 180 volts, grid No.3 connected to cathode, grid-No.2 voltage of 250 volts, grid-No.1 resistor of 0.1 megohm, and cathode resistor of 170 ohms.

Note 5: With 100 volts dc between heater and cathode.

Note 6: With grid No.1 100 volts negative with respect to all other electrodes tied together.

Note 7: With plate 300 volts negative with respect to all other electrodes tied together.

SPECIAL RATINGS & PERFORMANCE DATA

Heater-Cycling Life Performance:

This test is performed on a sample lot of tubes from each production run. A minimum of 2000 cycles of intermittent operation is applied under the following conditions: Heater voltage of 17 volts cycled one minute on and two minutes off, heater = 135 volts negative with respect to cathode, and all other elements connected to ground. At the end of this test, tubes are checked for heater-cathode shorts and open circuits.

Low-Frequency Vibration Performance:

This test is performed on a sample lot of tubes from each production run under the following conditions: Heater



7551

7551

BEAM POWER TUBE

voltage of 13.5 volts, plate voltage of 250 volts, grid-No.2 voltage of 250 volts, grid-No.1 voltage of -18 volts, plate load resistor of 2000 ohms, and vibrational acceleration of 2.5 g at 25 cps. In this test, the rms output voltage must not exceed 200 millivolts.

500-Hour Intermittent Life Performance:

This test is performed on a sample lot of tubes from each production run to insure high quality of the individual tube and to guard against epidemic failures. Life testing is conducted under the following conditions: Heater voltage of 15 volts and at maximum rated plate dissipation and grid-No.2 input.

CURVES

shown under Type 7558 also apply for the 7551
with the exception that $E_f = 13.5$ volts





7558

BEAM POWER TUBE

9-PIN MINIATURE TYPE

7558

GENERAL DATA

Electrical:

Heater, for Unipotential Cathode:

Voltage (AC or DC)	6.3 ± 5%	volts
Current	0.8	amp

Direct Interelectrode Capacitances:⁰

Grid No.1 to plate	0.15 max.	μf
Grid No.1 to cathode, grid No.3, grid No.2, and heater	10	μf
Plate to cathode, grid No.3, grid No.2, and heater	5.5	μf

Characteristics, Class A₁ Amplifier:

Plate Voltage	250	volts
Grid No.3	<i>Connected to cathode at socket</i>	
Grid-No.2 Voltage	250	volts
Grid-No.1 Voltage	-18	volts
Mu-Factor, Grid No.2 to Grid No.1	8.7	
Transconductance	5300	μmhos
Plate Current	40	ma
Grid-No.2 Current	3	ma

Mechanical:

Operating Position	Any
Maximum Overall Length	2-5/8"
Maximum Seated Length	2-3/8"
Length, Base Seat to Bulb Top (Excluding tip)	2" ± 3/32"
Diameter	0.750" to 0.875"
Dimensional Outline	<i>See General Section</i>
Bulb	T6-1/2
Base	Small-Button Noval 9-Pin (JEDEC No.E9-1)

Basing Designation for BOTTOM VIEW. 9LK

- Pin 1 - Cathode
- Pin 2 - Grid No.1
- Pin 3 - Grid No.2
- Pin 4 - Heater
- Pin 5 - Heater

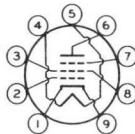

- Pin 6 - Plate
- Pin 7 - Grid No.3
- Pin 8 - Grid No.2
- Pin 9 - Cathode

AF POWER AMPLIFIER & MODULATOR — Class A₁

Maximum CCS[®] Ratings, Absolute-Maximum Values:

DC PLATE VOLTAGE	300 max.	volts
GRID No.3 (SUPPRESSOR GRID)	<i>Connect to cathode at socket</i>	
DC GRID-No.2 (SCREEN-GRID) VOLTAGE	250 max.	volts
MAX.-SIGNAL DC PLATE CURRENT [■]	70 max.	ma
MAX.-SIGNAL PLATE INPUT [■]	21 max.	watts
MAX.-SIGNAL GRID-No.2 INPUT [■]	2 max.	watts
PLATE DISSIPATION [■]	10 max.	watts

7558



7558

BEAM POWER TUBE

PEAK HEATER-CATHODE VOLTAGE:

Heater negative with respect to cathode. . .	100 max.	volts
Heater positive with respect to cathode. . .	100 max.	volts

BULB TEMPERATURE (At hottest point

on bulb surface)	225 max.	°C
----------------------------	----------	----

Typical CCS Push-Pull Operation:

Values are for 2 tubes

DC Plate Voltage	300	volts
Grid No.3.	Connected to cathode at socket	
DC Grid-No.2 Voltage ^g	250	volts
DC Grid-No.1 Voltage ^g	-21	volts
Peak AF Grid-No.1-to-Grid-No.1 Voltage . . .	40	volts
Zero-Signal DC Plate Current	40	ma
Max.-Signal DC Plate Current	125	ma
Zero-Signal DC Grid-No.2 Current	2	ma
Max.-Signal DC Grid-No.2 Current	14	ma
Effective Load Resistance (Plate to plate) .	5000	ohms
Max.-Signal Driving Power.	0	watts
Total Harmonic Distortion.	5	%
Max.-Signal Power Output (Approx.)	20.5	watts

Maximum Circuit Values:

Grid-No.1-Circuit Resistance	0.1 max.	megohm
--	----------	--------

RF POWER AMPLIFIER & OSCILLATOR — Class C Telegraphy[†]
and

RF POWER AMPLIFIER — Class C FM Telephony

Maximum Ratings, Absolute-Maximum Values:

Up to 175 Mc

CCS[•] ICAS^{••}

DC PLATE VOLTAGE	300 max.	300 max.	volts
GRID No.3 (SUPPRESSOR GRID). . .	Connect to cathode at socket		
DC GRID-No.2 (SCREEN-GRID) VOLTAGE.	250 max.	250 max.	volts
DC GRID-No.1 (CONTROL-GRID) VOLTAGE.	-125 max.	-125 max.	volts
DC PLATE CURRENT	70 max.	80 max.	ma
DC GRID-No.2 CURRENT	15 max.	15 max.	ma
DC GRID-No.1 CURRENT	5 max.	5 max.	ma
PLATE INPUT.	21 max.	24 max.	watts
GRID-No.2 INPUT.	2 max.	2 max.	watts
PLATE DISSIPATION.	10 max.	12 max.	watts

PEAK HEATER-CATHODE VOLTAGE:

Heater negative with respect to cathode	100 max.	100 max.	volts
Heater positive with respect to cathode	100 max.	100 max.	volts

BULB TEMPERATURE (At hottest

point on bulb surface)	225 max.	225 max.	°C
----------------------------------	----------	----------	----



7558

7558

BEAM POWER TUBE

Typical Operation:

As amplifier at 175 Mc

	CCS*		ICAS**	
DC Plate Voltage.	250	300	300	volts
Grid No.3	Connected to cathode at socket			
DC Grid-No.2 Voltage ^{□□}	200	200	250	volts
DC Grid-No.1 Voltage ^{⊕⊕}	-40	-42	-55	volts
Peak RF Grid-No.1 Voltage	47	52	62	volts
DC Plate Current.	60	70	80	ma
DC Grid-No.2 Current.	3.7	3.7	5.1	ma
DC Grid-No.1 Current (Approx.)	1.5	2.1	1.6	ma
Driver Power Output (Approx.) ^{▲▲}	1	1	1.5	watts
Useful Power Output (Approx.) [*]	6.5	8.5	10	watts

Maximum Circuit Values:

Grid-No.1-Circuit Resistance. . . 0.1 max. 0.1 max. megohm

PLATE-MODULATED RF POWER AMPLIFIER — Class C Telephony

Carrier conditions per tube for use
with a maximum modulation factor of 1

Maximum Ratings, Absolute-Maximum Values:

Up to 175 Mc

	CCS*	ICAS**	
DC PLATE VOLTAGE.	250 max.	250 max.	volts
GRID No.3 (SUPPRESSOR GRID)	Connect to cathode at socket		
DC GRID-No.2 (SCREEN-GRID) VOLTAGE	250 max.	250 max.	volts
DC GRID-No.1 (CONTROL-GRID) VOLTAGE	-125 max.	-125 max.	volts
DC PLATE CURRENT.	60 max.	70 max.	ma
DC GRID-No.2 CURRENT.	10 max.	10 max.	ma
DC GRID-No.1 CURRENT.	5 max.	5 max.	ma
PLATE INPUT	15 max.	17.5 max.	watts
GRID-No.2 INPUT	1.4 max.	1.4 max.	watts
PLATE DISSIPATION	7 max.	8 max.	watts
PEAK HEATER-CATHODE VOLTAGE: Heater negative with respect to cathode.	100 max.	100 max.	volts
Heater positive with respect to cathode.	100 max.	100 max.	volts
BULB TEMPERATURE (At hottest point on bulb surface).	225 max.	225 max.	°C

Typical Operation:

At 175 Mc

DC Plate Voltage.	250	250	volts
Grid No.3	Connected to cathode at socket		

7558



7558

BEAM POWER TUBE

	CCS [•]	ICAS ^{••}	
DC Grid-No.2 Voltage [▲]	250	250	volts
DC Grid-No.1 Voltage [★]	-70	-75	volts
From a grid-No.2 resistor of	33000	33000	ohms
RF Grid-No.1 Voltage	75	80	volts
DC Plate Current	60	70	ma
DC Grid-No.2 Current	2.5	3	ma
DC Grid-No.1 Current (Approx.)	2.1	2.3	ma
Driving Power (Approx.) ^{▲▲}	1	1	watt
Useful Power Output [*]	6.5	7.5	watts
Maximum Circuit Values:			
Grid-No.1-Circuit Resistance	0.1 max.	0.1 max.	megohm
FREQUENCY MULTIPLIER			
Maximum Ratings, Absolute-Maximum Values:			
	CCS [•]	ICAS ^{••}	
DC PLATE VOLTAGE	300 max.	300 max.	volts
GRID No.3 (SUPPRESSOR GRID)	<i>Connect to cathode at socket</i>		
DC GRID-No.2 (SCREEN-GRID) VOLTAGE	250 max.	250 max.	volts
DC GRID-No.1 (CONTROL-GRID) VOLTAGE	-125 max.	-125 max.	volts
DC PLATE CURRENT	50 max.	60 max.	ma
DC GRID-No.2 CURRENT	15 max.	15 max.	ma
DC GRID-No.1 CURRENT	5 max.	5 max.	ma
PLATE INPUT	13 max.	15 max.	watts
GRID-No.2 INPUT	2 max.	2 max.	watts
PLATE DISSIPATION	10 max.	12 max.	watts
PEAK HEATER-CATHODE VOLTAGE:			
Heater negative with respect to cathode	100 max.	100 max.	volts
Heater positive with respect to cathode	100 max.	100 max.	volts
BULB TEMPERATURE (At hot-test point on bulb surface).	225 max.	225 max.	°C
Typical Operation:			
<i>As doubler to 175 Mc</i>			
DC Plate Voltage	250	300	volts
Grid No.3	<i>Connected to cathode at socket</i>		
DC Grid-No.2 Voltage	200	250	volts
DC Grid-No.1 Voltage [⊕]	-53	-66	volts
From a grid-No.1 resistor of	53000	44000	ohms



7558

7558

BEAM POWER TUBE

Peak RF Grid-No.1			
Voltage	60	74	volts
DC Plate Current	50	60	ma
DC Grid-No.2 Current	2.6	3.5	ma
DC Grid-No.1 Current			
(Approx.)	1	1.5	ma
Driving Power (Approx.) ^{▲▲}	0.4	0.6	watt
Useful Power Output*	3	4.5	watts

As tripler at 175 Mc

DC Plate Voltage	200	250	volts
Grid No.3	<i>Connected to cathode at socket</i>		
DC Grid-No.2 Voltage	200	250	volts
DC Grid-No.1 Voltage ^{⊕⊕}	-90	-120	volts
From a grid-No.1			
resistor of	50000	70000	ohms
Peak RF Grid-No.1			
Voltage	105	130	volts
DC Plate Current	50	60	ma
DC Grid-No.2 Current	3	3.9	ma
DC Grid-No.1 Current			
(Approx.)	1.85	1.7	ma
Driving Power (Approx.) ^{▲▲}	0.4	0.6	watt
Useful Power Output*	1.4	2.3	watts

Maximum Circuit Values:

Grid-No.1-Circuit			
Resistance	0.1 max.	0.1 max.	megohm

- Without external shield.
- ◆ Subscript 1 indicates that grid-No.1 current does not flow during any part of the input cycle.
- Continuous Commercial Service.
- ⊕ Averaged over any audio-frequency cycle of sine-wave form.
- ⊕ Obtained preferably from a fixed supply.
- ⊕ Key-down conditions per tube without amplitude modulation. Amplitude modulation essentially negative may be used if the positive peak of of the audio-frequency envelope does not exceed 115% of the carrier conditions.
- ⊕ Intermittent Commercial and Amateur Service.
- Obtained preferably from a separate source or from the plate-voltage supply with a voltage divider. If a series resistor is used, it should be adjustable to obtain the desired operating plate current after initial tuning adjustments are completed.
- ⊕⊕ Obtained from a grid-No.1 resistor, or from a combination of grid-No.1 resistor with either fixed supply or cathode resistor.
- ▲▲ Driver stage is required to supply tube losses and rf-circuit losses. The driver stage should be designed to provide an excess of power above the indicated values to take care of variations in line voltage, components, initial tube characteristics, and tube characteristics during life.
- * Measured at load.
- ▲ Obtained preferably from a separate source modulated along with the plate supply, or from the modulated plate supply through a series resistor. It is recommended that this resistor be adjustable to obtain the desired operating plate current after initial tuning adjustments are made.

7558



7558

BEAM POWER TUBE

* Obtained from a grid-No.1 resistor or from a combination of grid-No.1 resistor with either fixed supply or cathode resistor. The combination of grid-No.1 resistor and fixed supply has the advantage of not only protecting the tube from damage through loss of excitation but also of minimizing distortion by bias-supply compensation.

CHARACTERISTICS RANGE VALUES FOR EQUIPMENT DESIGN

	Note	Min.	Max.	
Heater Current	1	0.745	0.855	amp
Transconductance	1,2	4200	6400	μ mhos
Plate Current	1,2	30	50	ma
Plate Current	1,3	-	50	μ a
Grid-No.2 Current	1,2	-	7.5	ma
Reverse Grid-No.1 Current . . .	1,4	-	2	μ a
Heater-Cathode Leakage Current:				
Heater negative with respect to cathode	1,5	-	20	μ a
Heater positive with respect to cathode	1,5	-	20	μ a
Leakage Resistance:				
Between grid-No.1 and all other electrodes tied together	1,6	100	-	megohms
Between plate and all other electrodes tied together	1,7	100	-	megohms

Note 1: With 6.3 volts ac or dc on heater.

Note 2: With plate voltage of 250 volts, grid No.3 connected to cathode, grid-No.2 voltage of 250 volts, and grid-No.1 voltage of -18 volts.

Note 3: With plate voltage of 250 volts, grid No.3 connected to cathode, grid-No.2 voltage of 250 volts, and grid-No.1 voltage of -48 volts.

Note 4: With plate voltage of 180 volts, grid No.3 connected to cathode, grid-No.2 voltage of 250 volts, grid-No.1 resistor of 0.1 megohm, and cathode resistor of 170 ohms.

Note 5: With 100 volts dc between heater and cathode.

Note 6: With grid No.1 100 volts negative with respect to all other electrodes tied together.

Note 7: With plate 300 volts negative with respect to all other electrodes tied together.



7558

7558

AVERAGE CHARACTERISTICS

$E_f = 6.3$ VOLTS
GRID N^o 3 CONNECTED TO CATHODE AT SOCKET.
GRID-N^o 2 VOLTS=200

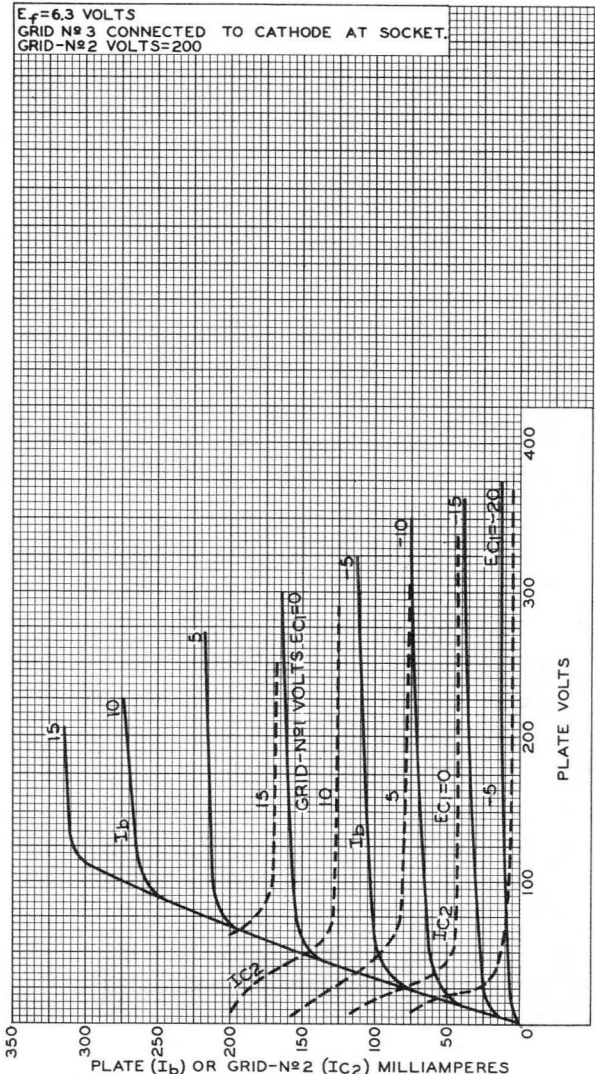

7558



7558

AVERAGE CHARACTERISTICS

$E_f = 6.3$ VOLTS
 GRID N^o3 CONNECTED TO CATHODE AT SOCKET.
 GRID-N^o2 VOLTS=250

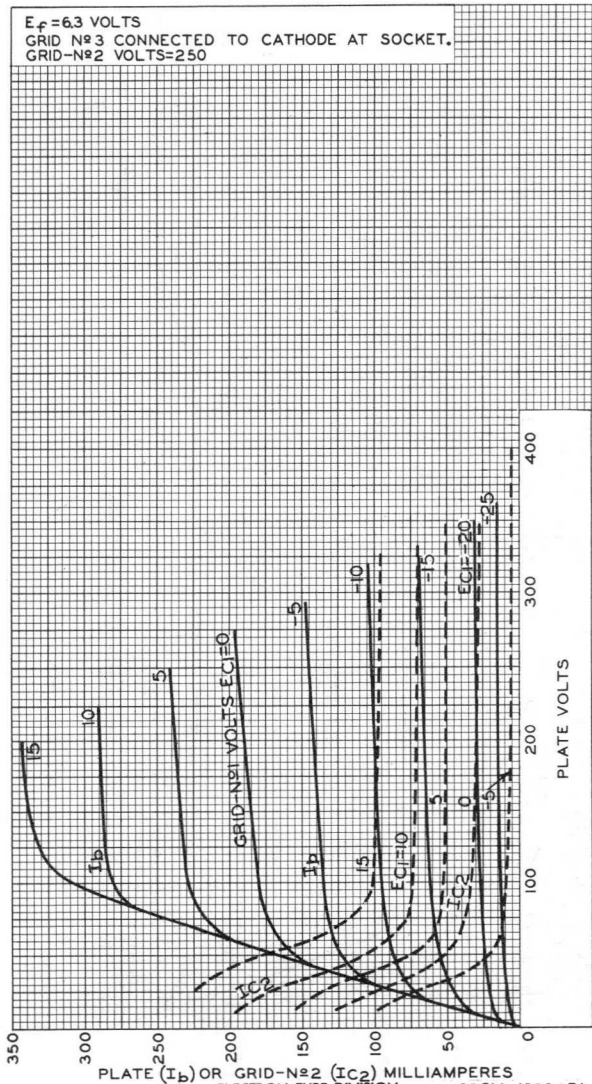

ELECTRON TUBE DIVISION 92CM-10304 R1
 RADIO CORPORATION OF AMERICA, HARRISON, NEW JERSEY



7558

7558

AVERAGE CHARACTERISTICS

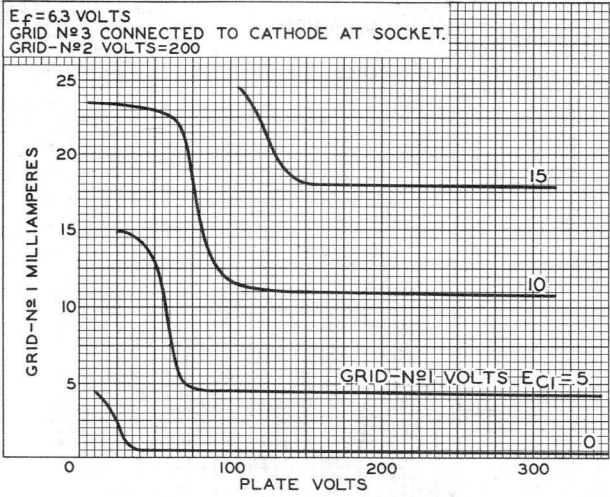

92CS-10306RI

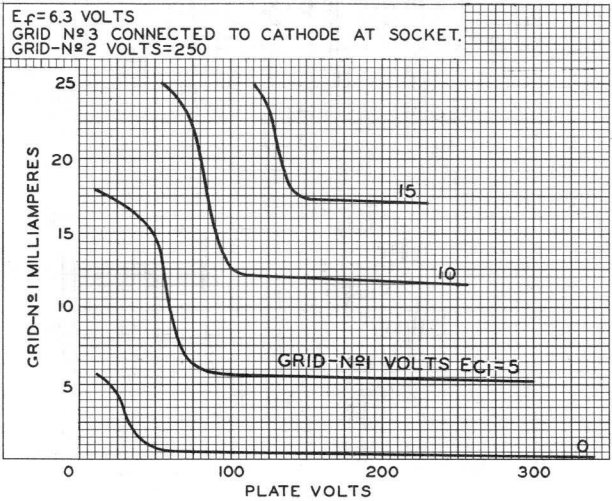

92CS-10307RI

7558



7558

AVERAGE CONSTANT-CURRENT CHARACTERISTICS

$E_f = 6.3$ VOLTS
 GRID-N^o3 CONNECTED TO CATHODE AT SOCKET.
 GRID-N^o2 VOLTS=200
 I_b = PLATE MILLIAMPERES
 I_{C2} = GRID-N^o2 MILLIAMPERES
 I_{C1} = GRID-N^o1 MILLIAMPERES

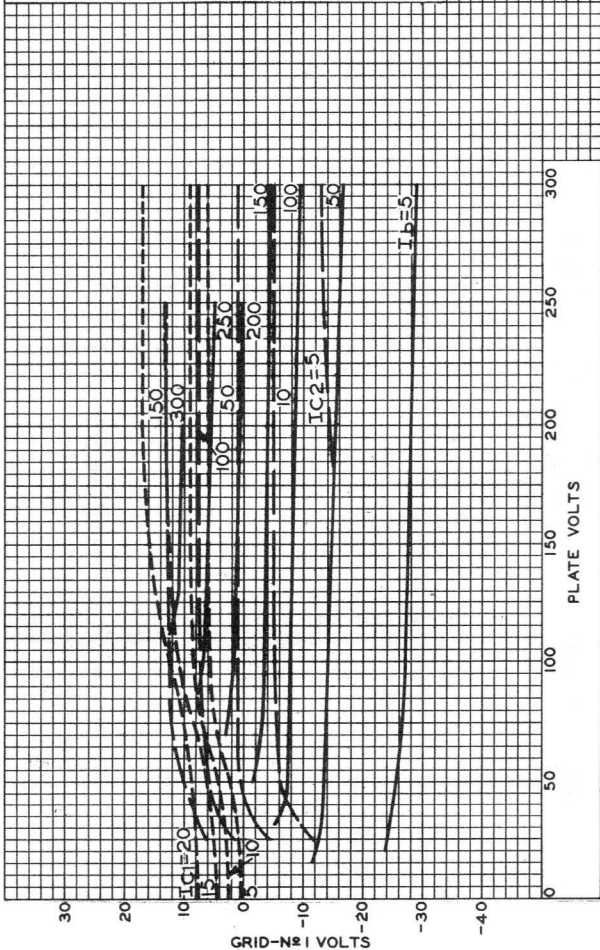

ELECTRON TUBE DIVISION

RADIO CORPORATION OF AMERICA, HARRISON, NEW JERSEY

92CM-10303RI



7558

7558

AVERAGE CONSTANT-CURRENT CHARACTERISTICS

$E_f = 6.3$ VOLTS
GRID-Nº 3 CONNECTED TO CATHODE AT SOCKET.
GRID-Nº 2 VOLTS = 250
 I_b = PLATE MILLIAMPERES
 I_{C2} = GRID-Nº 2 MILLIAMPERES
 I_{C1} = GRID-Nº 1 MILLIAMPERES

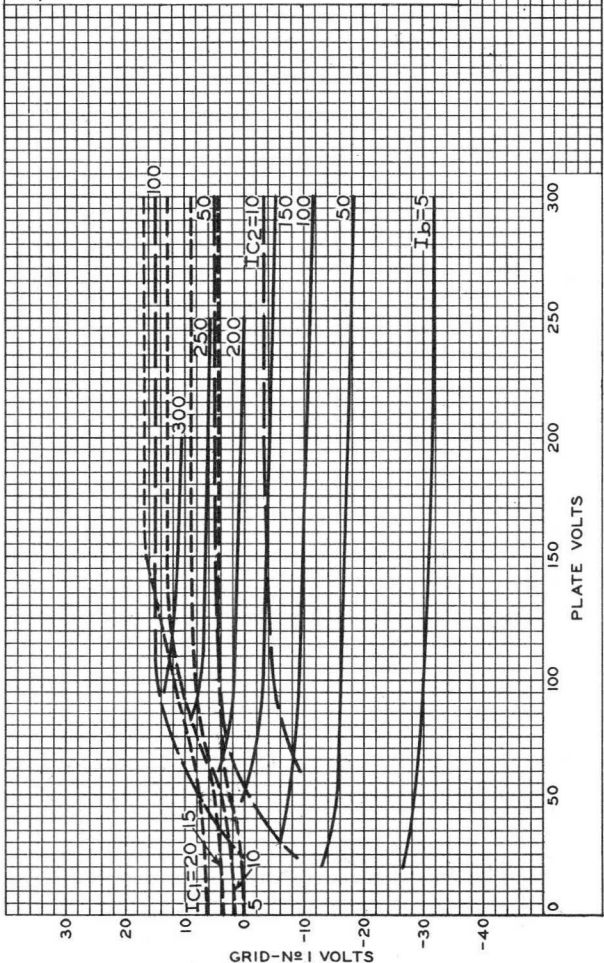

GRID-Nº 1 VOLTS

ELECTRON TUBE DIVISION

RADIO CORPORATION OF AMERICA, HARRISON, NEW JERSEY

92CM-10308RI

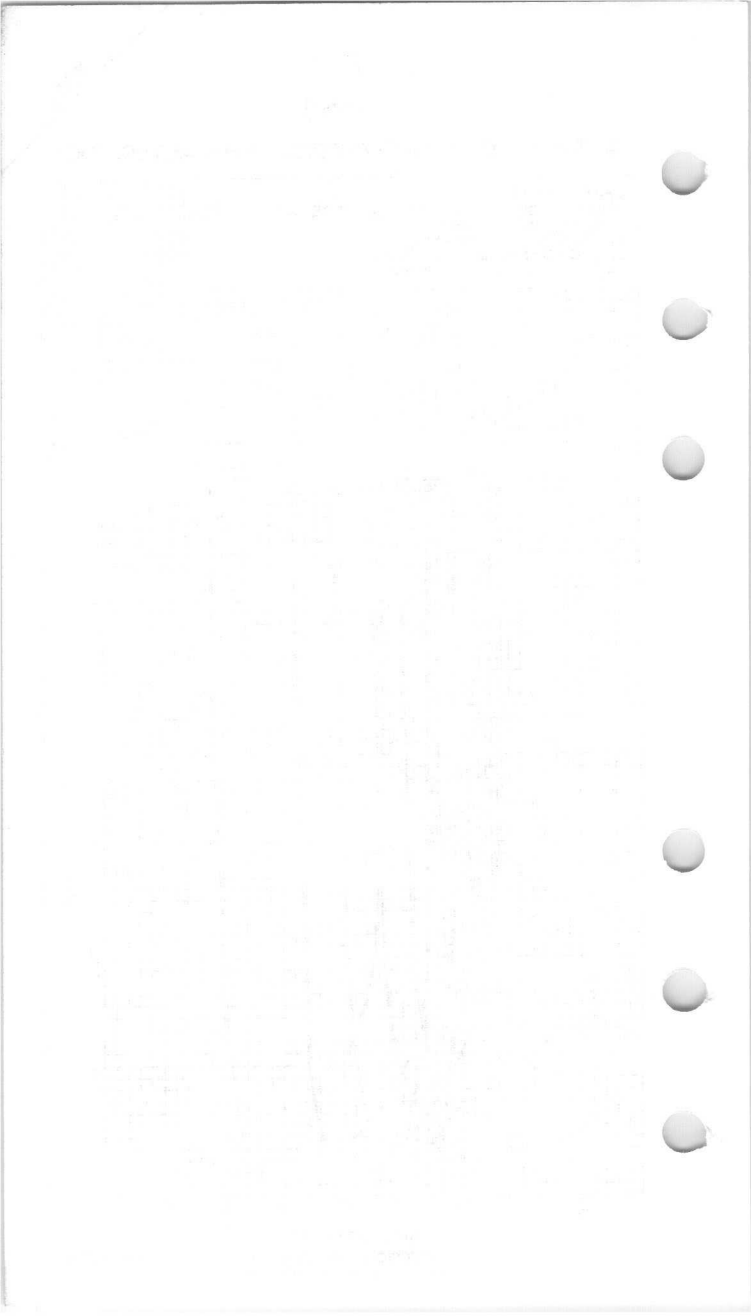

Power Pentode

NOVAR TYPE

For Output Stages of High Fidelity
Audio-Amplifiers and Radio Receivers

ELECTRICAL

Heater Characteristics and Ratings:

Voltage (AC or DC)	6.3 ± 0.6	volts
Current at heater volts = 6.3	0.800	amp
Maximum Heater-Cathode Voltage:		
Heater negative with respect to cathode.	200	volts
Heater positive with respect to cathode		
Peak	200	volts
DC component	100	volts

Direct Interelectrode Capacitances (Approx.):^a

Grid No.1 to plate	0.15	pf
Input: G1 to (K + G3, G2, H).	11.0	pf
Output: P to (K + G3, G2, H)	4.4	pf

MECHANICAL

Operating Position	Any
Type of Cathode	Coated Unipotential
Maximum Overall Length	3.110 in
Maximum Seated Length	2.730 in
Diameter	1.062 to 1.188 in
Bulb	T9
Dimensional Outline	See <i>General Section</i>

Bases (Alternates):

Small-Button Novar 9-Pin	(JEDEC No.E9-75)
Small-Button Novar 9-Pin with Exhaust Tip	(JEDEC No.E9-89)

BASING DESIGNATION (Bottom View)

- Pin 1-Grid No.2
- Pin 2-Grid No.1
- Pin 3-Cathode, Grid No.3
- Pin 4-Heater
- Pin 5-Heater
- Pin 6-Grid No.1
- Pin 7-Grid No.2
- Pin 8-LC - See *Note*
- Pin 9-Plate

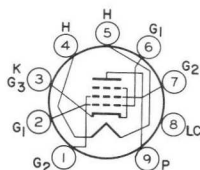

9RW

Note: May be used as tie point for components operating at or near the DC voltage of either the grid No.2 or plate, or between these voltages. Otherwise, do not use.

AF POWER AMPLIFIER — Class A1

Maximum Ratings, *Design-Maximum Values:*

Plate Voltage	550	volts
Grid-No.2 (Screen-Grid) Voltage	440	volts
Cathode Current	90	ma
Grid-No.2 Input	3.3 ^b	watts
Plate Dissipation	19	watts
Bulb Temperature (At hottest point on bulb surface).	240	°C

← Indicates a change.



RADIO CORPORATION OF AMERICA
Electronic Components and Devices Harrison, N. J.

DATA 1
10-66

Typical Operation and Characteristics:

Plate Voltage.	300	volts
Grid-No.2 Voltage.	300	volts
Grid-No.1 (Control-Grid) Voltage.	-10	volts
Peak AF Grid-No.1 Voltage.	10	volts
Zero-Signal Plate Current.	60	ma
Max.-Signal Plate Current.	75	ma
Zero-Signal Grid-No.2 Current.	8	ma
Max.-Signal Grid-No.2 Current.	15	ma
Plate Resistance (Approx.)	29000	ohms
Transconductance	10200	μ mhos
Effective Load Resistance.	3000	ohms
Total Harmonic Distortion.	13	%
Max.-Signal Power Output	11	watts

Maximum-Circuit Values:

Grid-No.1-Circuit Resistance:

For fixed-bias operation	0.3	megohm
For cathode-bias operation	1	megohm

PUSH-PULL AF POWER AMPLIFIER — Class AB₁**Maximum Ratings, Design-Maximum Values:**

Plate Voltage.	550	volts
Grid-No.2 (Screen-Grid) Voltage.	440	volts
Cathode Current.	90	ma
Grid-No.2 Input.	3.3 ^b	watts
Plate Dissipation.	19	watts
Bulb Temperature (At hottest point on bulb surface)	240	$^{\circ}$ C

Typical Operation:*Values are for 2 tubes*

	Fixed Bias					Cathode	
						Bias	
Plate Supply							
Voltage.	300	350	400	450	450	450	volts
Grid-No.2 Supply							
Voltage.	300	350	350	350	400	400	volts
Grid-No.1 Voltage.	-12.5	-15.5	-16	-16.5	-21	c	volts
Cathode Resistor (Common to both cathodes).	-	-	-	-	-	170	ohms
Peak AF Grid-No.1- to-Grid-No.1							
Voltage.	25	31	32	33	42	31	volts
Zero-Signal Plate Current.	74	72	64	60	40	86	ma
Max.-Signal Plate Current.	116	130	135	142	145	94	ma
Zero-Signal Grid- No.2 Current.	10	9.5	8	7.2	5	10	ma
Max.-Signal Grid- No.2 Current.	28	32	28	26	30	20	ma



	Fixed Bias					Cathode Bias	
Effective Load Resistance (Plate to plate)	6600	6600	6600	6600	6600	10000	ohms
Total Harmonic Distortion	5	2.5	2	2.5	5	2	%
Max.-Signal Power Output	24	30	34	38	44	28	watts

Maximum Circuit Values:

Grid-No.1-Circuit Resistance:

For fixed-bias operation	0.3	megohm
For cathode-bias operation	1	megohm

PUSH-PULL AF POWER AMPLIFIER — Class AB₁

Grid No. 2 of each tube connected to tap on plate winding of output transformer

Maximum Ratings, Design-Maximum Values:

Plate and Grid-No.2 (Screen-Grid)

Supply Voltage	440	volts
DC Cathode Current	90	ma
Grid-No.2 Input	3.3 ^b	watts
Plate Dissipation	19	watts
Bulb Temperature (At hottest point on bulb surface).	240	°C

Typical Operation:*Values are for 2 tubes*

	Fixed Bias	Cathode Bias	
Plate Supply Voltage	400	425	volts
Grid-No.2 Supply Voltage	d	d	volts
Grid-No.1 Voltage	-20.5	c	volts
Cathode Resistor (Common to both cathodes)	-	185	ohms
Peak AF Grid-No.1-to-Grid-No.1 Voltage	41	42	volts
Zero-Signal Plate Current	60	88	ma
Max.-Signal Plate Current	115	100	ma
Zero-Signal Grid-No.2 Current	8	12	ma
Max.-Signal Grid-No.2 Current	18	16	ma
Effective Load Resistance (Plate to plate)	6600	6600	ohms
Total Harmonic Distortion	2.5	3.5	%
Max.-Signal Power Output	23	21	watts

Maximum Circuit Values:

Grid-No.1-Circuit Resistance:

For fixed-bias operation	0.3	megohm
For cathode-bias operation	1	megohm



- a Without external shield.
 b Grid-No. 2 input may reach 6 watts during peak levels of speech and music signals.
 c Connected to negative end of cathode resistor.
 d Obtained from tap on the primary winding of the output transformer. The taps are located on each side of the center-tap (B+) so as to supply 50 per cent of the plate signal voltage to the grid No. 2 of each output tube.

Operation Characteristics

Push-Pull Class AB₁

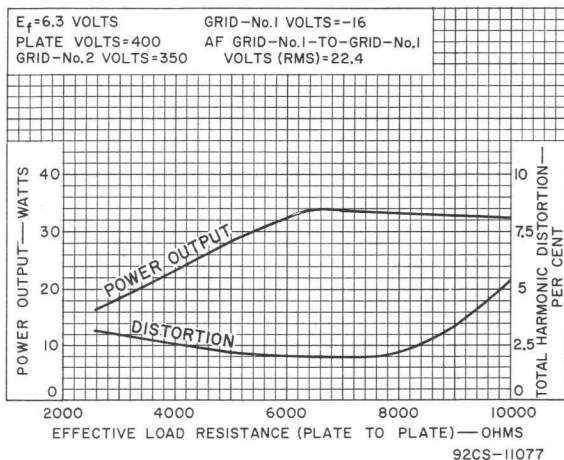

AVERAGE PLATE CHARACTERISTICS

$E_f = 6.3$ VOLTS
 GRID—No. 1 VOLTS=0

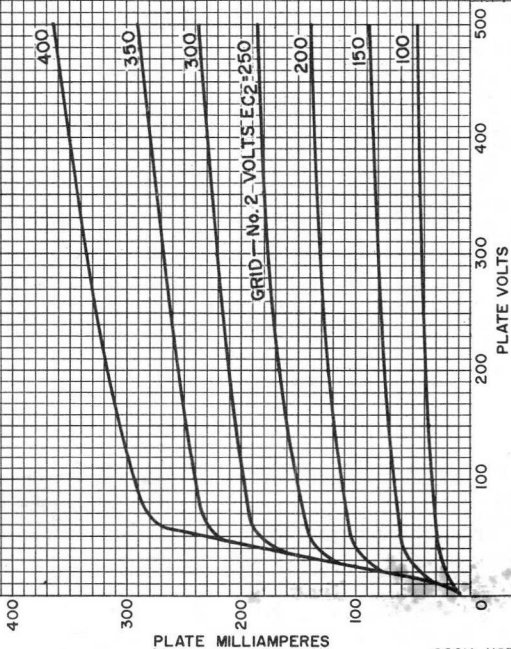

92CM-11074



AVERAGE CHARACTERISTICS

