

 MICROWAVE TUBES AND DEVICES

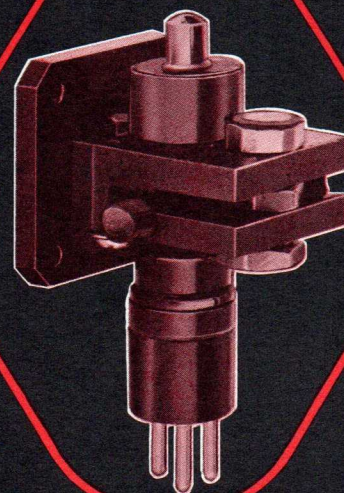
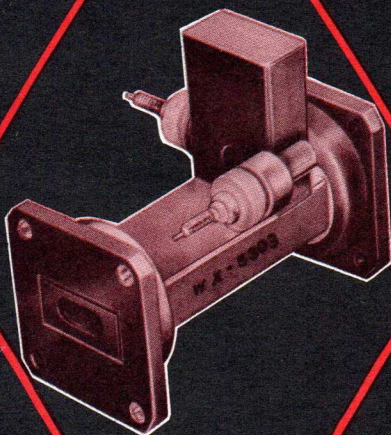
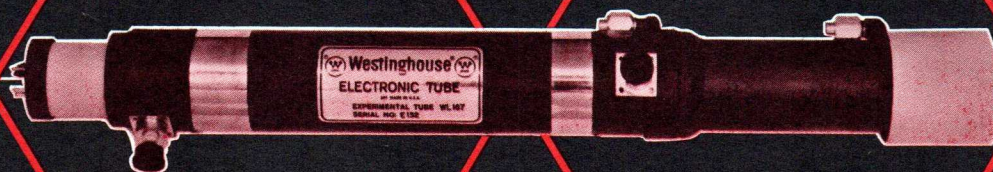
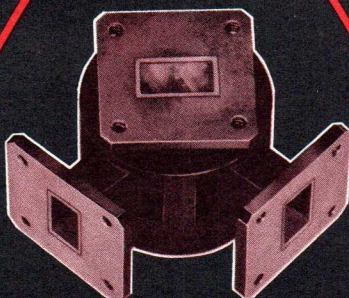
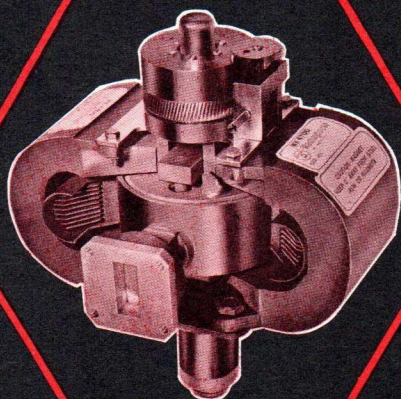

Westinghouse

ELECTRONIC TUBE DIVISION

ELMIRA, NEW YORK

WEST
3

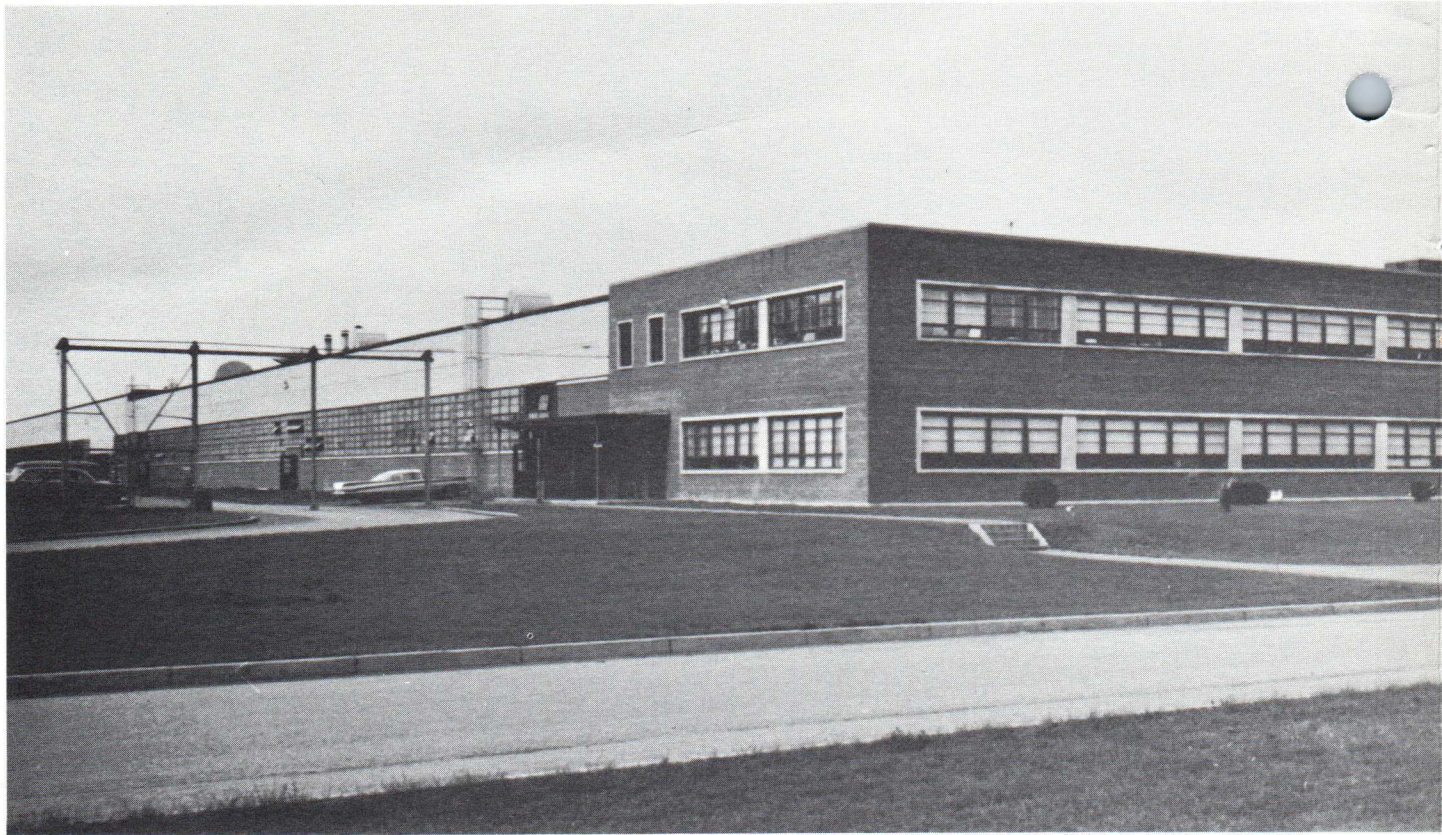

WESTINGHOUSE PLANT WHERE MICROWAVE TUBES ARE MADE IN ELMIRA, NEW YORK

INDEX	Page
PULSED MAGNETRONS	4, 5
CW MAGNETRONS	6
TRAVELING WAVE TUBES	7
REFLEX KLYSTRONS and OPTIONS	8, 9, 10
SPECIAL MICROWAVE SWITCHES	11
GAS SWITCHES	12, 13
CAVITIES	14, 15
TEST EQUIPMENT	16, 17
FACILITIES and CAPABILITIES	18, 19
SALES OFFICES	Back Cover

INFORMATION IN THIS BOOKLET IS CURRENT MAY, 1963

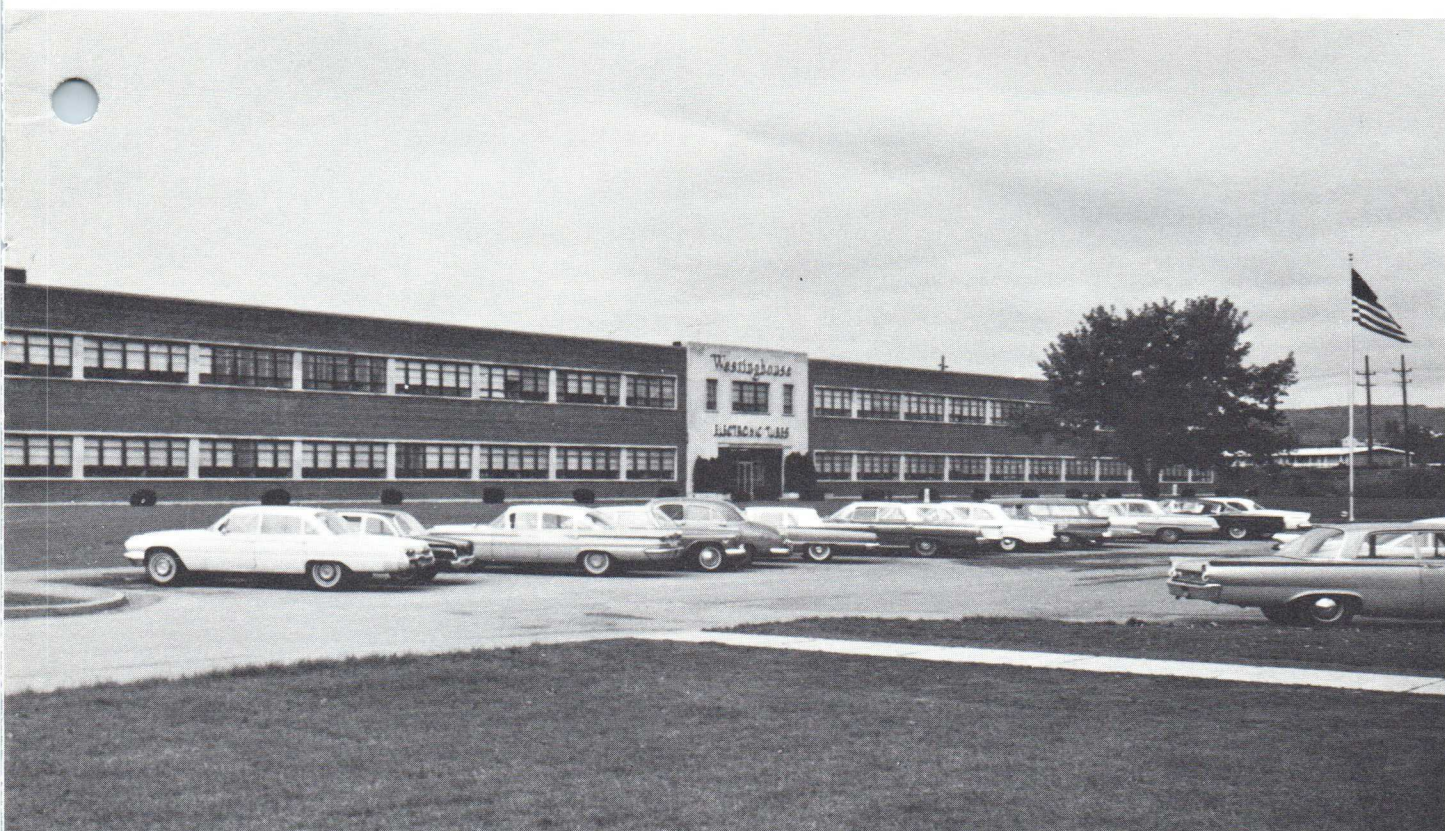

Westinghouse TUBES... *at microwave frequencies*

At microwave frequencies from 1000 mc to 93 Gc, Westinghouse works with both active and passive devices to maintain a position of leadership for the Free World.

Microwave systems manufacturers are asking their engineers and research people to accomplish more difficult tasks — show better definition, increase the range, improve the life, track more targets, identify decoys, make it smaller, make it more efficient, make it cheaper. Most systems are compromises of these requests. Systems customers for microwave tubes are limited by the capability of their tube supplier. This basic limitation may be in originating new ideas or in manufacturing products already approved. This limitation can be minimized by turning to Westinghouse, an established company in microwave that has new people, new plants, new research laboratories and new ideas. Three research laboratories and one university are working on microwave devices that will provide advanced performance in the next generation of microwave systems. Your company or agency already may be a Westinghouse customer. If so you will recognize some of the products in this catalog. Here are shown and briefly described the more popular and available tubes and devices. All products shown can be delivered within 90 days. Other microwave developments and tubes can be disclosed on a need-to-know basis. More complete technical data sheets are available on request. Call the Westinghouse sales office that serves you. There are fifty-two offices throughout the U.S.A. Three international locations serve the foreign market. See the back cover for complete listings.



PULSED MAGNETRONS

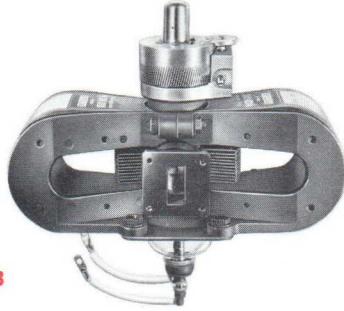

WL-6249B
WL-193

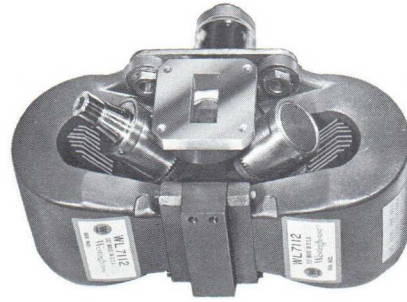

WL-7112

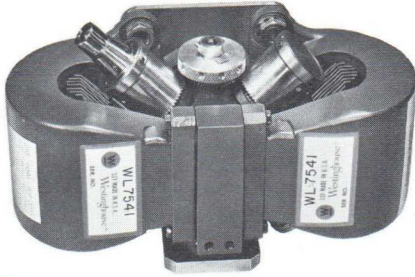

WL-7541



WX-3737



WL-7008

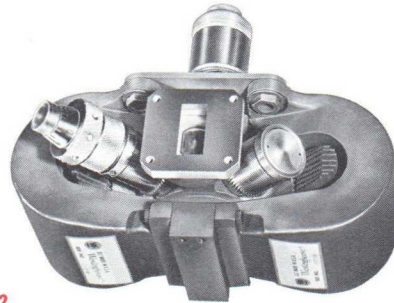

WX-4742



WL-7110
WL-6865A

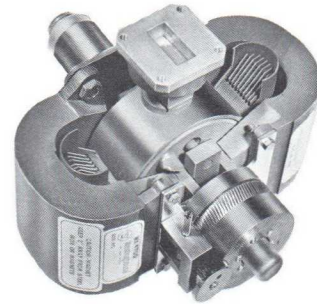

WX-4700



WL-7111



WL-7794



WL-7795

PULSED MAGNETRONS

TYPE	FREQUENCY Gc	POWER OUTPUT KW	DUTY	MAX. PULSE WIDTH μ sec.	PULSE VOLTAGE KV	TUNING	COMMENTS
WL-7794	4.2-4.4	0.1	0.05	—	0.8	Hand Tuned	This tube is a CW tube for amplitude modulated systems which has been given a pulse rating to permit use in pulse coded systems.
WL-7795	4.2-4.4	0.1	0.05	—	0.8	Fixed Tuned	Same as the 7794 except fixed tuned.
WL-6249B	8.5-9.6	250	0.001	3.3	28	Servo Tuned-Pin Tuner	This low cost tube provides maximum performance in the severe environment of military aircraft. Proven life in excess of 500 hours results from the use of a unique high temperature cathode. The tuner design, incorporating a pin type tuner, provides reliable performance across the tuning range.
WL-7008	8.5-9.6	230	0.001	2.8	22	Servo Tuned-Coupled Cavity	This tube is intended for new airborne equipments where a high degree of stability afforded by the coupled cavity tuners is desired. This tube provides excellent spectra and is especially resistant to moding at fast voltage rise times. The tube operates at the impedance and voltage level of the 4J50.
WL-7110	8.5-9.6	230	0.001	2.8	22	Hand Tuned-Coupled Cavity	Similar to the 7008 except for external mechanical tuning mechanism.
WL-7111	8.5-9.6	230	0.001	2.8	22	Hand Tuned-Coupled Cavity	Similar to the 7008 except for external mechanical tuning mechanism.
WL-7112	8.5-9.6	230	0.001	2.8	22	Servo Tuned-Coupled Cavity	Similar to the 7008 except servo tuning shaft located opposite the waveguide output.
WL-6865A	8.75-9.6	200	0.001	2.8	22	Hand Tuned-Coupled Cavity	Similar to the 7111 except for power, frequency range and location of tuning knob.
WL-7541	8.75-9.6	250	0.001	2.8	22	Hand Tuned-Coupled Cavity	Similar to the 7111 except for power, and location of tuning knob. For severe environments.
WL-193	8.5-9.6	250	0.001	3.3	28	Servo Tuned-Pin Tuner	Similar to the 6249B except improved FMing and power stability characteristics.
WX-3737	8.5-9.6	600 400	— 0.001	0.5 3.0	— 30	Servo Tuned-Pin Tuner	This tube features especially high power and is particularly suitable as a pulsed oscillator for component testing.
WX-4700	8.5-9.6	250	0.001	2.8	22	Servo Tuned-Coaxial Tuning Cavity	This tube provides the ultimate in frequency stability required of the most advanced airborne radars. It can be used as a replacement for the 7008 and 7111 type magnetrons. The tube features coaxial cavity construction.
WX-4742	8.5-9.6	230	0.001	2.8	22	Hand Tuned and Electrically Tuned Coupled Cavity	This tube is identical to the 7111 except an additional electromechanically actuated step tuner is provided to permit alternate pulse operation at two frequencies.



CW MAGNETRONS



WL-7794



WX-4529



**WL-6177
WL-7795
WL-7796**

TYPE	FREQ. Gc	POWER OUTPUT Watts	OPERATING VOLTAGE Volts	CATHODE CURRENT mA	FREQ. MOD. Mc	TUNING	COMMENTS
WX-4529	4.2-4.4	1.0	-250	—	1.0	Fixed Frequency	This tube is designed for AM modulated communications, radar or altimeter systems. In pulse modulated systems, peak power up to 2 watts at 0.5 duty is available.
WL-6177	4.25-4.35	1.0	300	30	76	Electro-Mechanically	This tube is an electromechanically driven, frequency modulated magnetron designed for airborne radar altimeters.
WL-7794	4.2-4.4	5.0	-425	30	1.0	Hand Tuned	This tube is intended for amplitude modulated communications, telemetering and relay systems. 100% modulation is permitted.
WL-7795	4.2-4.4	5.0	-425	30	1.0	Fixed Tuned	Similar to the WL-7794.
WL-7796	4.2-4.4	2.0	-350	30	200	Electro-Mechanically Modulated	This tube is designed for airborne applications in counter measure or altimeter systems requiring frequency modulation. The center frequency can be d.c. controlled.

TRAVELING WAVE TUBES



WX-5405

The WX-5405 is a pulse traveling wave amplifier especially designed for cathode pulsed service. The tube has similar ratings to the WL-167 except for the elimination of the high mu grid.



WL-167

10 KW 5.4 to 6.0 GC 0.025 Duty

The WL-167 is a PPM focused pulsed traveling wave amplifier tube providing 10 KW peak power output with 40 db gain in the frequency range of 5400 to 6000 megacycles. A high mu gridded gun is used which permits modulation of the beam with a 500 volt applied grid pulse. Maximum duty cycle is .025. An insulated water cooled collector which can be depressed for efficiency enhancement is provided. Cooling water is in contact with ground potential elements only. The tube is of metal-ceramic construction and includes an integral temperature compensated periodic permanent magnet focusing structure. The complete tube package weighs 14 pounds. The tube is designed for reliable, long life operation in military environments. A continuously operating ion pump is included to minimize degradation of characteristics over extended service life. Particular emphasis has been placed on phase characteristics for use in applications such as phased array radar systems.

ELECTRICAL CHARACTERISTICS

Heater:	
Voltage	12 Volts
Current	2.5 Amperes
Anode Voltage	24 KV
Saturated Power Output, Peak	10 KW
Gain at Saturated Power Output	40 db
Pulse Width, Max.	5 μ sec.
Focusing Method	Integral periodic permanent magnet temperature compensated.
Cold Insertion Loss, Min.	100 db

MECHANICAL DATA

Mounting Position	Any
Dimensions:	
Length	24"
Diameter (Not including Connectors)	2 5/8"
Weight	14 lbs.
RF Connectors	Special 50 ohm coax.
Cooling:	
Water, at Ground Potential	0.3 gpm at 10 psi pressure drop
Coolant Temperature	50° to 100° F
Shock	30G

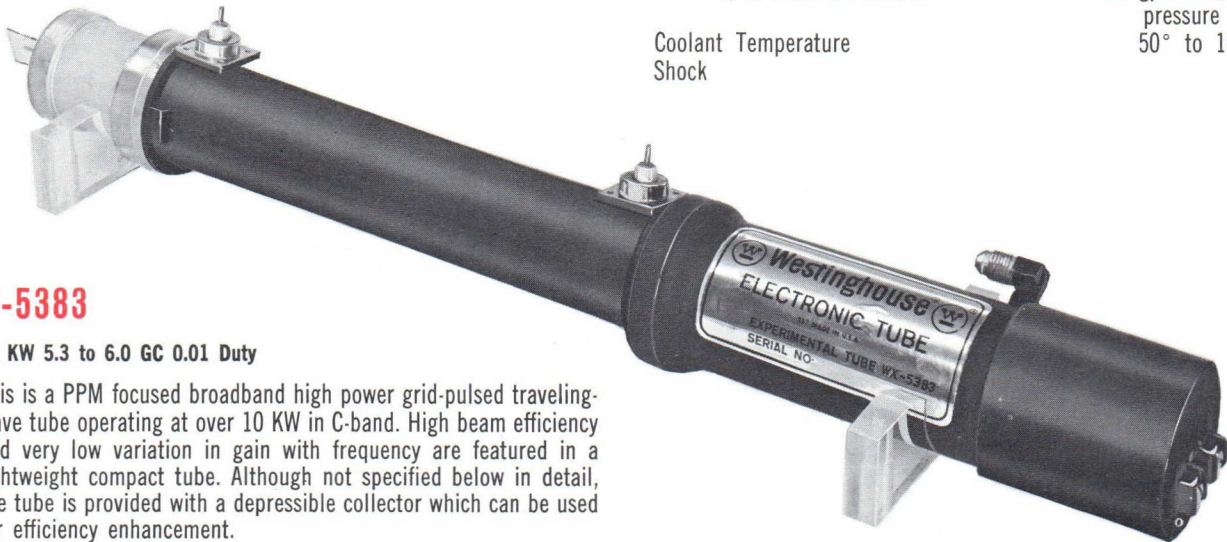

W-5383

10 KW 5.3 to 6.0 GC 0.01 Duty

This is a PPM focused broadband high power grid-pulsed traveling-wave tube operating at over 10 KW in C-band. High beam efficiency and very low variation in gain with frequency are featured in a lightweight compact tube. Although not specified below in detail, the tube is provided with a depressible collector which can be used for efficiency enhancement.

TENTATIVE SPECIFICATIONS

Anode voltage — 23 KV
 Grid drive voltage — 300V, max.
 Beam current — 3 amp
 Saturation gain — 40 db min.
 Gain variation with freq. — ± 1 db max.
 Peak power output — 10 KW min.

Focusing — PPM, Temperature Compensated
 Length — 22 inches
 Weight — 8 pounds
 Cooling — Water (0.2 gpm at 5 psi drop)
 RF connector — special coax. 50 ohm
 Duty cycle — 0.01
 Coolant Temp. — 50° to 100° F



REFLEX KLYSTRON

Westinghouse produces a wide variety of reflex klystrons suitable for use in such applications as local oscillators, pumps for parametric amplifiers, bench oscillators and low power transmitters. Various forms of connectors and tuning mechanisms are available. For more complete information ask for the Klystron Quick Selector or individual data sheets. In addition, Westinghouse is producing several C and X-band reflex klystrons which represent the latest in the state-of-the-art for ruggedness and reliability. Further information is available on a need-to-know basis.

The following combinations of connection methods, tuning methods and tuning adapters are available.

TYPES OF CONNECTORS



TOP CAP AND BASE

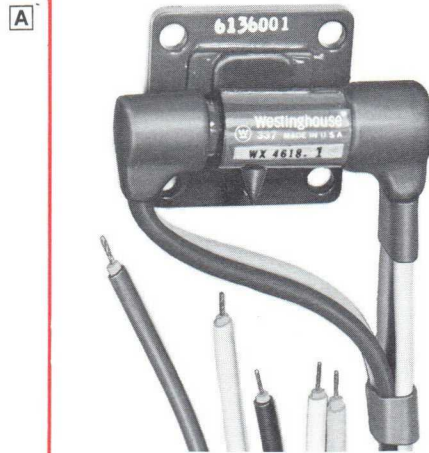

FLYING LEADS

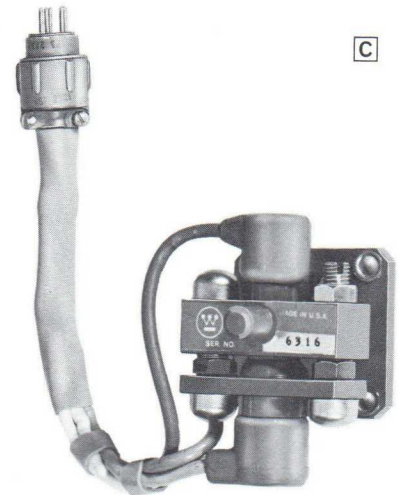

FLYING LEADS AND VIKING CONNECTOR

TUNING METHODS

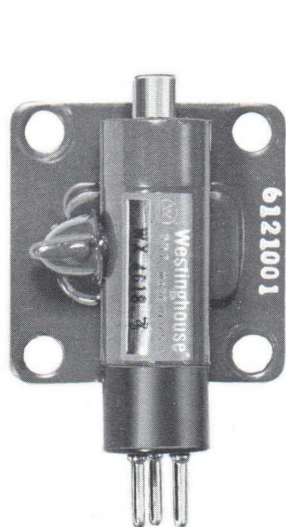

FIXED FREQUENCY



**FIXED FREQUENCY
WITH ± 100 mc TRIMMING
DIFFERENTIAL SCREW**



**DIFFERENTIAL SCREW
CAVITY TUNING**

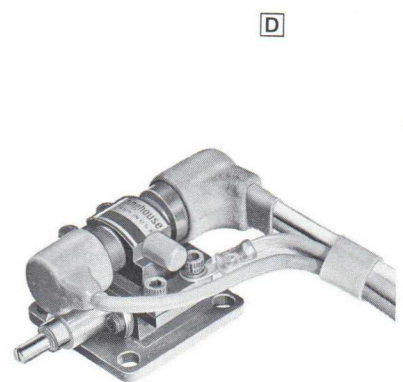

**SINGLE SCREW
WAVEGUIDE TUNING**

REFLEX KLYSTRONS



The tabulation below is a partial list of tubes available.

The tubes listed below may be operated in different modes to secure both higher or lower power output and electronic bandwidth.

TYPE	FREQUENCY Gc	POWER NOMINAL mW	BEAM VOLTAGE Vdc	REFLECTOR VOLTAGE AVERAGE Vdc	BAND- WIDTH NOMINAL Mc	CONNEC- TION METHOD	TUNING METHOD	TUNING ADAPTER	COMMENTS
WL-107	7.5-11.0	180	500	-325	45	A	C	D**	Designed for bench oscillator service.
WL-128	8.1-12.4	180	500	-325	45	A	C	D**	Designed for bench oscillator service.
WL-109	8.5-11.0	55	300	-150	40	B	A	—	Rugged design to give excellent stability under extreme environmental conditions. Specify desired frequency when ordering.
WL-177	8.5-11.0	725	500	-315	55	B	B	—	Designed for use in doppler navigation systems and parametric amplifiers. Excellent characteristics under adverse environmental conditions. Specify desired frequency when ordering.
WL-6310	8.5-10.0	85	300	-150	40	A	C	A	Designed for local oscillator service. Rugged construction provides good environmental characteristics.
WL-6780	8.5-10.0	22	200	-115	30	C	C	C	Same as WL-6781 except designed for fixed frequency operation. Lock nut tuner provides fixed frequency operation at any point in the band.
WL-6781	8.5-10.0	22	200	-115	30	C	C	B	Designed for operation at low beam voltage.
WL-191	8.5-10.0	650	500	-340	50	A	C	A	Designed for laboratory use where maximum power over a wide tuning range is desired.
WL-192	9.2-10.0	225	350	-250	38	B	D	A	Designed for servo tuned systems. It features the ultimate in stability under severe environmental conditions.
WL-119	11.0-14.0	450	500	-320	50	B	B*	—	Similar to the WL-177 except for frequency.
WL-110	12.4-14.5	220	600	-300	50	A	C	D**	Designed for local oscillator and transmitter service.
WL-108	12.4-18.0	120	600	-265	50	A	C	D**	Designed for bench oscillator and signal generator service.
WL-111	14.0-17.5	100	600	-265	50	A	C	D**	Similar to the WL-110 except for frequency.

* Trimming screw in vertical plane.

** Also available with micrometer barrel. See page 10, reference E.

WL-22669 16:1 tuning adapter may be used with any Westinghouse slotted shaft cavity tuned klystron.



KLYSTRON OPTIONS

TUNING ADAPTERS



A

SLOTTED SHAFT

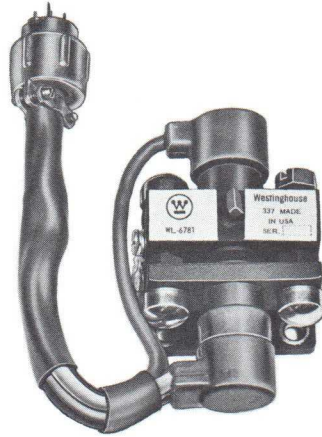

B

HEXAGON NUT HEAD

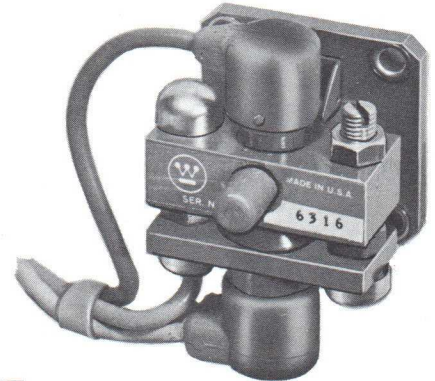

C

LOCK NUT

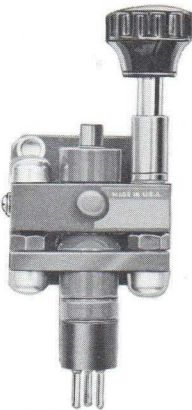

D

TUNING* KNOB

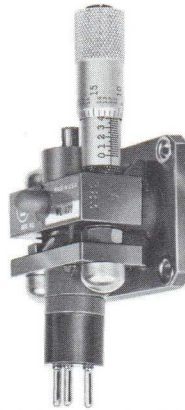

E

MICROMETER BARREL

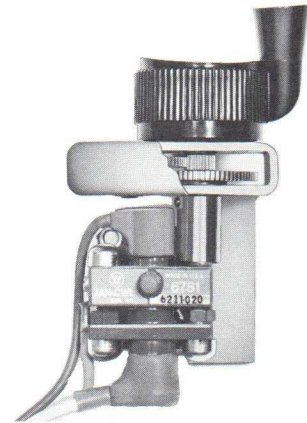

16:1 TUNING* ADAPTER WL22669

* Particularly suitable for bench oscillators and test equipment.

SPECIAL REQUIREMENTS



HIGH ENVIRONMENT

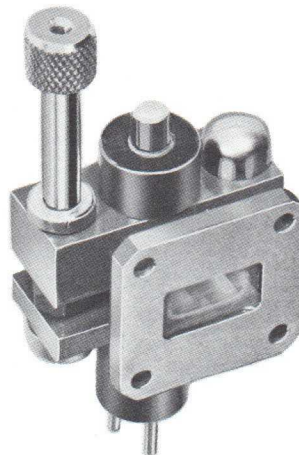

SPECIAL TUNING ADAPTERS

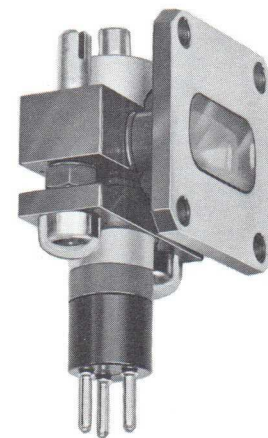

GOLD PLATED SURFACES

Other special klystron requirements can be designed or manufactured to your specifications. If you have a klystron problem or idea, discuss it first with Westinghouse.

SPECIAL MICROWAVE SWITCHES



WX-3845 X-BAND 4 PORT JUNCTION

The WX-3845 is a pre-TR tube built around a four port junction. The junction consists of a symmetrical Y junction in quarter height X-band waveguide with a circular output aperture. The tube provides rapid switching under high power conditions in a special purpose microwave network of an advanced radar system. This gas tube, weighing ounces, replaced a heavy ferrite unit which required a driver modulator and power supply to provide switching.

ELECTRICAL CHARACTERISTICS

VSWR	1.7:1	Average Power	25 W
Insertion Loss	0.5 db max.	Recovery Time	10 μ sec. max.



WX-4018/4019 X-BAND COMBINATION TR AND ATR

This tube is a complex junction switch which performs both TR and ATR functions. The device was developed to meet requirements of an unusual multifunction microwave junction.

Waveguide Size	RG-51/U	Duty	0.001	Insertion Loss	0.4 db (for TR) max.
Peak Power	300 kW	Recovery Time	10 μ sec. max.	Application	Switching of special purpose microwave junction

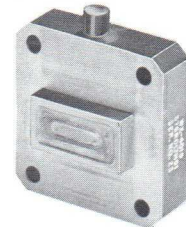

WX-5303 X-BAND TAIL CLIPPING SWITCH

The WX-5303 is a unique "tail clipping" switch which can be used to reduce the fall time of a transmitter pulse to the range of 10 nanoseconds and to reduce the output pulse width. The tube is triggered by means of a 2 KV pulse applied to a control electrode. It can be designed to operate over any 100 mc band in X-band to meet specific requirements.

Insertion Loss — 0.4 db	Pulse Width — 0.5 μ sec.	Breakdown Time — 15 nanoseconds
VSWR — 1.15 (center frequency)	Repetition Rate — 1000 pps	Fired Isolation — 15 db
RF Peak Power — 80 KW	Trigger Voltage — 2 KV	

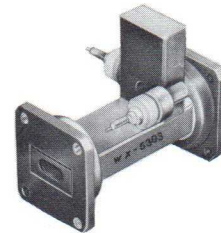

WX-4238 C-BAND HIGH VACUUM SWITCH

The WX 4238 is a high vacuum, controllable, C-band microwave switch that utilizes the principle of secondary emission to obtain very rapid firing and recovery times. Application of an external dc or pulse voltage will prevent the tube from firing and allow the rf power to be transmitted through the tube. The device may be used as a pre-TR tube, it may be paired and used in a balanced duplexer, or it may be paired and used as a SPDT switch in phased array antenna systems.

Band Width	Approx. 0.5% to 1.0% Tuneable over an 8% to 10% band	Peak Power	1000 KW	Isolation	25 db
		Duty Factor	0.001	VSWR	1.3:1
		Recovery Time	less than one R.F. cycle	Insertion Loss	0.9 db
				Transmit Loss	0.4 db

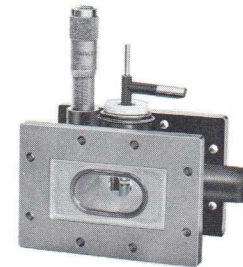

WX-5080 C-BAND SOLID STATE SWITCH ISOLATION 80 DB

The WX-5080 is a high isolation SPST C-band microwave switch. No dc bias is required to maintain the high isolation, thus simplifying logic circuitry. Additional switch designs are available that will provide as many as five throw positions.

Frequency — 5.4 to 5.9 gc	Switching Speed — 40 nanoseconds	DC Bias — zero
Isolation — 80 db min.	Switching Voltage — 8V max. @ 25 ma	Video Impedance — 50 ohms
Insertion Loss — 3 db max.		RF Impedance — 50 ohms
		RF Power — 1 watt (CW)



WX-5329 C-BAND SOLID STATE SWITCH 1 NS SWITCHING

The WX-5329 is a high speed, C-band, SPST low power microwave switch. No applied bias is required to maintain 40 db of isolation, thus simplifying logic circuitry. At a forward current of 25 ma the insertion loss is one db (max.). This switch is suitable for missile environment.

Frequency — C-band 10% BW	Insertion Loss — 1 db	DC Bias — zero
Isolation — 30 db	Switching Speed — 1 nanosecond	Video Impedance — 50 ohms
Frequency — C-band 3% BW	Switching Voltage — 2 Volts peak 1.2V @ 25 ma	RF Impedance — 50 ohms
Isolation — 40 db		RF Power — 100 milliwatts (CW)





GAS SWITCHING TUBES



WX-4404

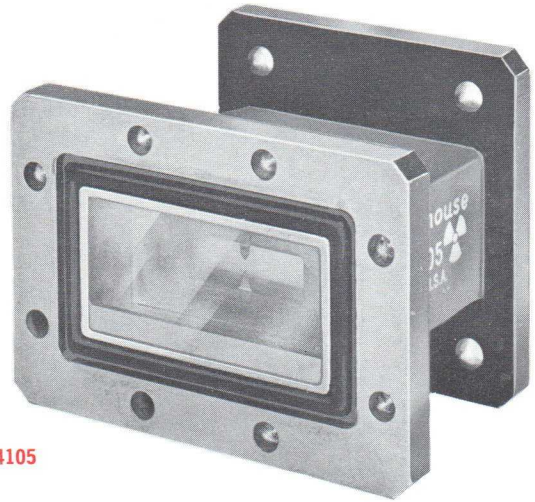

WX-4105



WX-4405



WX-4239

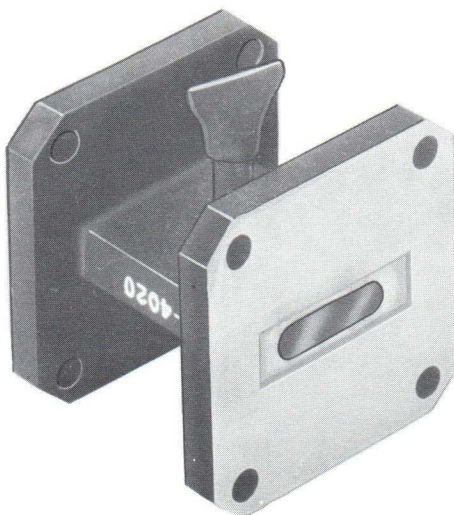

WX-4020

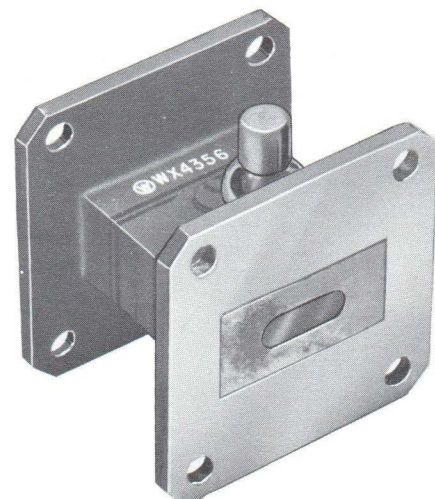

WX-4356

GAS SWITCHING TUBES



The tubes listed below offer special switching characteristics not normally found in other switch tubes. Modification of these tubes or designs to meet special requirements are available on request.

PROTECTORS

TUBE TYPE	FREQUENCY Gc	PEAK POWER	DUTY	PRR KC	RECOVERY TIME USEC-Max. 3db Point	FLAT LEAKAGE POWER PEAK WATTS	INSERTION LOSS db Max.	COMMENTS
WX-4404	2.32-2.68	250 KW	0.004	—	30	100	0.2	The WX-4404 is a high power S-band ultra low loss pre-TR used for protecting the traveling wave tube in a radar receiver without significant degradation of noise figure. It can also be used in conjunction with a crystal protector to provide standard TR operation.
WX-4105	5.1-5.65	1.0 KW	0.1	80	0.2	50	0.2	This is a rapid recovery C-band pre-TR tube designed for use in low peak power, high average power pulse doppler systems.
WX-4405	5.28-5.56	1.0 KW	0.1	80	0.2	0.07	0.75	The WX-4405 is a C-band rapid recovery time TR tube. It is designed for operation in modern pulse doppler radar systems and may be preceded by a ferrite circulator. The tube guarantees crystal protection with the capability of recovering to within 3 db of the insertion loss value in less than 0.2 microseconds.
WX-4239	5.55-5.9	1.0 KW	0.1	80	0.2	0.60	0.2	The WX-4239 is a low insertion loss microwave switch tube designed to protect solid state switches or as a TWT protector used in pulse doppler radar systems.
WX-4020	9.2-10.0	50-400 W	0.265	80	0.15	1.00	0.3	This is a fast recovery pre-TR tube for use in pulse doppler radar systems.
WX-4356	10.0-10.3	200 W	0.1	80	0.2	0.06	0.6	The WX-4356 is an X-band, fast recovery time crystal protector. It is designed for use in modern pulse doppler radar systems and may be preceded by a pre-TR and/or a ferrite circulator. This tube guarantees crystal protection with the capability of recovery times of less than 0.2 microseconds.



DISCRIMINATOR CAVITIES

Discriminator cavities are dual-mode frequency stabilizing devices. With crystal diodes connected to their outputs, they form a complete F-M discriminator. They have applications with parametric amplifier pumps, navigation systems, beacon radars, and any system needing a stable frequency source. They are vacuum sealed and incorporate invar construction to minimize frequency shift with ambient temperature change. Discriminator cavities can be built on special order for any frequency from 1000 Mc to 50,000 Mc.

C-BAND WX-5408

This is a two-cavity frequency discriminator.

Center frequency*	5625 Mc
Frequency difference between outputs	6 Mc
Loaded Q each output	1000 min.
Insertion loss input to each output	4.5 db
Insertion loss difference between outputs	.5 db

*Other frequencies available upon request

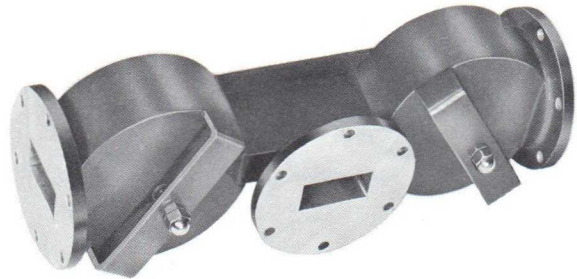

X-BAND WX-5380

This is functionally the same as WX-5402.

Center frequency	9.7-12.4 Gc
Frequency difference between outputs	1.5-1.8 Mc



REFERENCE CAVITIES

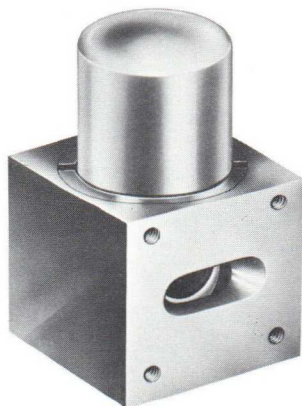

WX-3622

TEMPERATURE COMPENSATED CAVITY

9250.00 Mc \pm .30 Mc

Transmission Type Reference Cavity

The WX-3622 is one of a family of cavities designed to replace the 1Q series in more sophisticated systems. This cavity is useful in airborne applications as a frequency reference. It is especially suited to standing wave discriminators. It has superior low temperature compensation. This cavity has a relatively high Q and is matched.

ELECTRICAL CHARACTERISTICS

Temperature Compensation -55°C to $+71^{\circ}\text{C}$	\pm .30 Mc max.
Input VSWR	1.4 max.
Loaded Q	2100 to 2400
Insertion Loss	4 to 6 db
Pulling Figure	\pm .6 Mc

Additional Data Available on Request.

TYPICAL CAVITY RESULTS

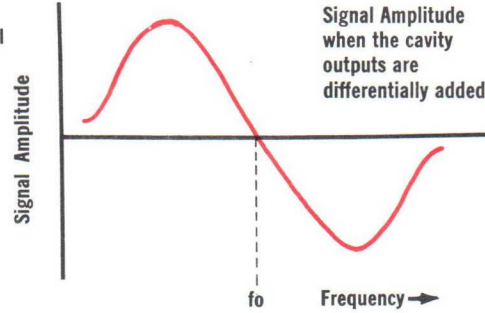
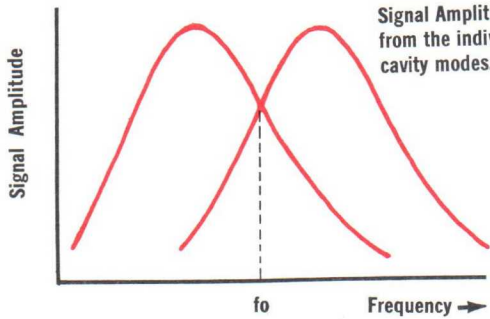

Typical circuit*

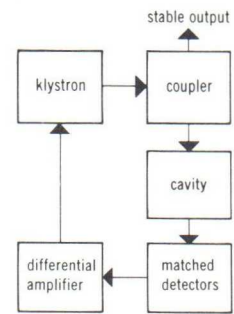

*PATENTED BY SPERRY RAND CORP. U. S. PATENT NO. 2,502,456

KU-BAND WX-5402

This is a fixed frequency dual-mode cavity available with center frequency preset within ± 0.5 Mc.

Center Frequency*	12.4-18 Gc
Frequency difference between outputs	1.8-2.8 Mc
Loaded Q each output	6500 min.
Insertion loss input to each output	10 db
Insertion loss difference between outputs	1 db

*Picture shows tube set to 13,300 Mc

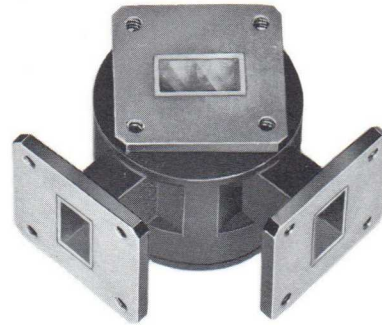

KA-BAND WX-4334

Center Frequency	35,000 Mc
Frequency Difference Between Outputs	10 Mc
Loaded Q Each Output	3,000 min.
Insertion Loss Input to Each Output	10 db
Insertion Loss Difference Between Outputs	1 db

WX-4515 is a temperature compensated version of the WX-4334. With temperature change of -55°C to $+100^{\circ}\text{C}$ the resonant frequency change is ± 2 Mc.



WL-1Q22

WL-1Q23

WL-1Q24

WL-1Q25

WL-5846

WL-6040

WL-6041



The 1Q Series and the 5846, 6040, and 6041 are fixed frequency transmission type, vacuum sealed cavity tubes. They are designed for operation at specific frequencies as frequency determining devices in radar systems and IFF Systems.

These reference cavities are electrically identical except for their resonant frequencies. They are also alike mechanically except for the 5846 which is provided with an attenuator card slot. Except for the 5846, these cavities can be pressurized.

ELECTRICAL CHARACTERISTICS

Loaded Q	1900 to 2400
Insertion Loss at Resonant Frequency	4 to 6 db

RESONANT FREQUENCIES:

1Q22	9250 \pm 0.5 Mc	5846	9280 \pm 0.5 Mc
1Q23	9280 \pm 0.5 Mc	6040	9308 \pm 0.5 Mc
1Q24	9310 \pm 0.5 Mc	6041	9312 \pm 0.5 Mc
1Q25	9375 \pm 0.5 Mc		

TEMPERATURE COMPENSATION:

From 25°C to 0°C	± 0.3 max. Mc
From 25°C to -55°C	± 1.2 max. Mc
From 25°C to 100°C	± 0.3 max. Mc

Additional Data Available on Request.



TEST EQUIPMENT

For over thirty-five years, Westinghouse has developed test equipment needed for development and manufacture of all types of electronic tubes. This long experience in the test equipment field coupled with an intimate knowledge of testing requirements gained through its own tube manufacturing program insures test equipment of superior design and quality. This equipment is ideally suited for incoming inspection, production lines or wherever wide range of flexibility or high volume testing is needed.

Test equipment is offered for klystrons, traveling wave tubes, magnetrons and TR Tubes. Equipment will be designed by Westinghouse to the user's performance requirements or built to user's design.

The equipment shown here illustrates the design and manufacturing capabilities of Westinghouse.

KLYSTRON TEST SET

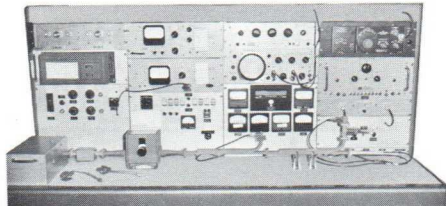

TEST CAPABILITIES:

*RF power to $\pm 10\%$ * Reflector Voltage and Current to $\pm 5\%$
* Anode Voltage and Current to $\pm 5\%$ * Filament Voltage and Current to $\pm 5\%$ * Modulation Sensitivity * FM and AM Noise * AM Distortion.

INPUT POWER:

127 V A.C., 60 cycles, single phase 3 wire, 3 kW.

TUBE INPUT:

Eresonator — 0 - 600 V D.C. at 0 - 200 ma. 1 mv. max. ripple, line regulation .05%, load regulation .05%.

This piece of equipment contains measuring equipment, and signal generators as well as power supplies needed to perform production tests on small reflex klystrons in the frequency 2.0-35.0 GC with maximum power output up to 1 watt. It is intended as a universal unit for testing all small klystrons. Thus, it is especially suited for incoming inspection of a large variety of klystrons. The high rate of testing makes 100% inspection at incoming test practical.

Ereflector — 0 - 1000 V D.C. at 0 - 20 ma., 1 mv. max. RMS ripple, .005% for 10% line change regulation; .005% load regulation, no load to full load.

Efilament — 0 - 15 V at 2A D.C.
0 - 15 V at 2A 60 cycles.
0 - 15 V at 2A 400 cycles.

Signal — Saw Tooth: 300 V peak to peak 20 - 500 KC

Generators — Square Wave: 300 V peak to peak 20 - 500 KC

Sine Wave: 300 V peak to peak 0 - 500 KC

2 V peak to peak 750 KC, 2.25 Mc

TEST SET FOR PULSED MAGNETRONS



This test set is specially designed to make high precision RF measurements on magnetrons at the rate of several hundred tubes per month. Special attention has been given to increasing operator speed and to reduction of operator fatigue.

TEST CAPABILITIES:

* RF Power. A direct calorimetric method permits precision to $\pm 5\%$. Power to 300 kW peak and 300 watts average can be measured at a VSWR variable from 1.0 to 1.5. * Bandwidth. This measurement employs a visual display of the RF Spectrum which can be measured to a precision of ± 0.005 MC. RF Spectrum can be measured at variable power levels at a VSWR variable from 1.0 to 1.5. * Pushing and pulling tests under various conditions of power and VSWR. Pushing is measured by a special electronic circuit which eliminates confusion due to thermal effects. * Stability. These tests are made by a special Westinghouse designed missing pulse detector which counts pulses having less than a preselected percent of full power variable from 60% to 100% by 5% steps. Stability test includes partial moding and stability during rapid tuning of the magnetron frequency. VSWR may be varied from 1.0 to 1.5. * Such tests as backlash, tuning linearity and thermal drift are also provided.

INPUT POWER:

3 phase, 20 V, 15 amp, 60 cycles.

Pulse power capability: 1 megawatt at 0.1% duty ratio, (typical operation: 600 kW at 0.1% duty). Line type pulser DC resonant charging pulsewidths of any combination of three such as 0.25, 1.0 and 2.5 microseconds can be provided.

RF Power: Capability to measure RF average power to 300 watts using calorimetric method (facility of reading power directly). A complete waveguide system is available.

TEST EQUIPMENT



MISSING PULSE DETECTOR



The Westinghouse Magnetron Missing Pulse Detector provides a precise quantitative indication of the inadequate or missing pulses generated by a magnetron during a pre-set and definite interval of time.

TEST CAPABILITY:

This missing pulse detector is capable of precise determination of the number of pulses having lower than a preselected energy content. The following tests can be performed. * Pulse to pulse percentage variable from 60% to 100%. * Partial Moding Stability. * Stability during Tuning. * Short Pulse Stability (to 0.25 microsecond).

TEST MODULATOR FOR PULSE DOPPLER GAS SWITCHES

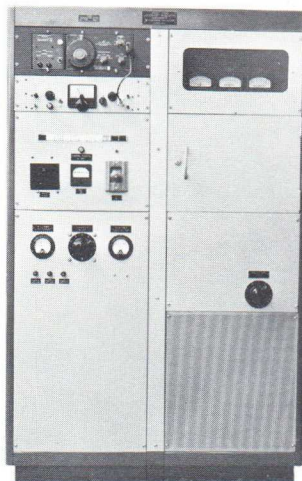

This modulator is designed for testing fast recovery switch tubes. It simulates a short pulse high duty operation typical of pulse doppler radar systems. Pulse widths from 0.1 to 5.0 microseconds with duty to 100%. Power output is continuously variable from 0 to 600 watts RF frequency range can be supplied to order from 1.0 to 10.0 Gd.

TRAVELING WAVE TUBE TEST SET

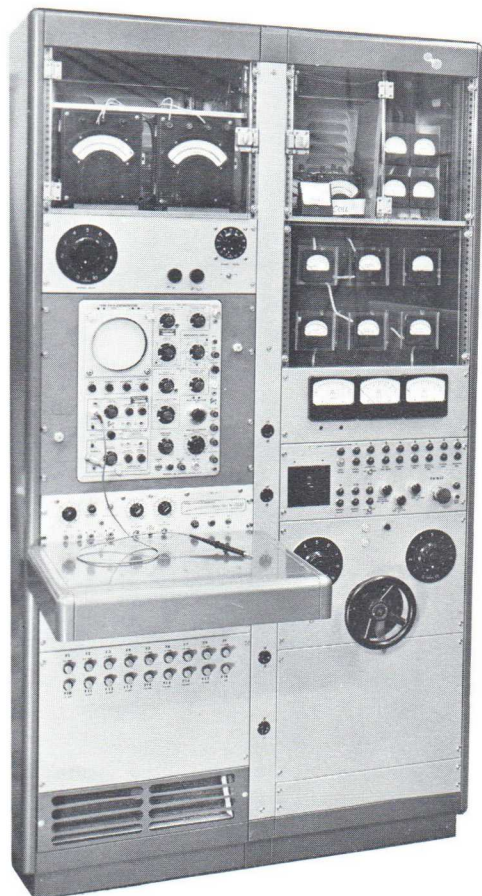

This set consists basically of 3 high voltage power supplies, filament supply, solenoid supply, grid modulator, crowbar circuit and associated metering as follows:

High Voltage Supply #1 (Cathode Supply)

Output: -30 kV D.C. at .15 amp average continuously variable.

Load may be increased to .30 amp for short periods (15 min. or less). Ripple .5% rms with balanced 3 phase input. A crowbar circuit is used in conjunction with this high voltage supply to protect the tube under test.

High Voltage Supply #2 (Collector)

Output: -15kV D.C. at .15 amp average continuously variable from 0 volts.

Load may be increased to .20 amp for short periods (15 min. or less). Ripple .5% rms with balanced 3 ϕ input.

High Voltage Supply #3 (Depressed Collector)

Output: 2 scales (0 to -15 kV D.C. and -15 kV D.C. to -30 kV D.C.)

Continuously variable over each range. Output current .15 amp average, may be increased to .20 amp for short periods (15 min. or less). Ripple .5% rms with balanced 3 ϕ input.

All power supplied may be connected with either + or - side grounded.

Filament Supply: Variable 0 to 30V at 10 amp.

Solenoid Supply: 0-120 Volts D.C. at 20 amp output. Continuously variable.

Grid Modulator

(Chassis isolated for 30 kV D.C.)

Rep. Rate: 33 cps to 20 kc

Bias Voltage: Variable from -20V to -200V.

Total Pulse swing variable to 400V peak to peak.

Pulse width: .5 to 70 μ sec.



MICROWAVE TUBE FACILITIES AND CAPABILITIES

Microwave tube facilities — both engineering and manufacturing — of Westinghouse are current with the state-of-the-art. From precision parts making through final testing, this product family is being improved as new techniques and processes are mastered. For example, the benefits of clean room assembly that are so well established in other product areas, are now applied to microwave tube assembly operations. The latest in low vacuum pressure techniques are used to exhaust microwave tubes and to maintain that vacuum through as many processing steps as possible. There is nothing so unique about these facilities. But the people who use them are dedicated and resourceful. They realize fully how much your system performance depends on their work from day to day. They realize that your microwave systems are at the heart of the free world's detection, communication and defensive

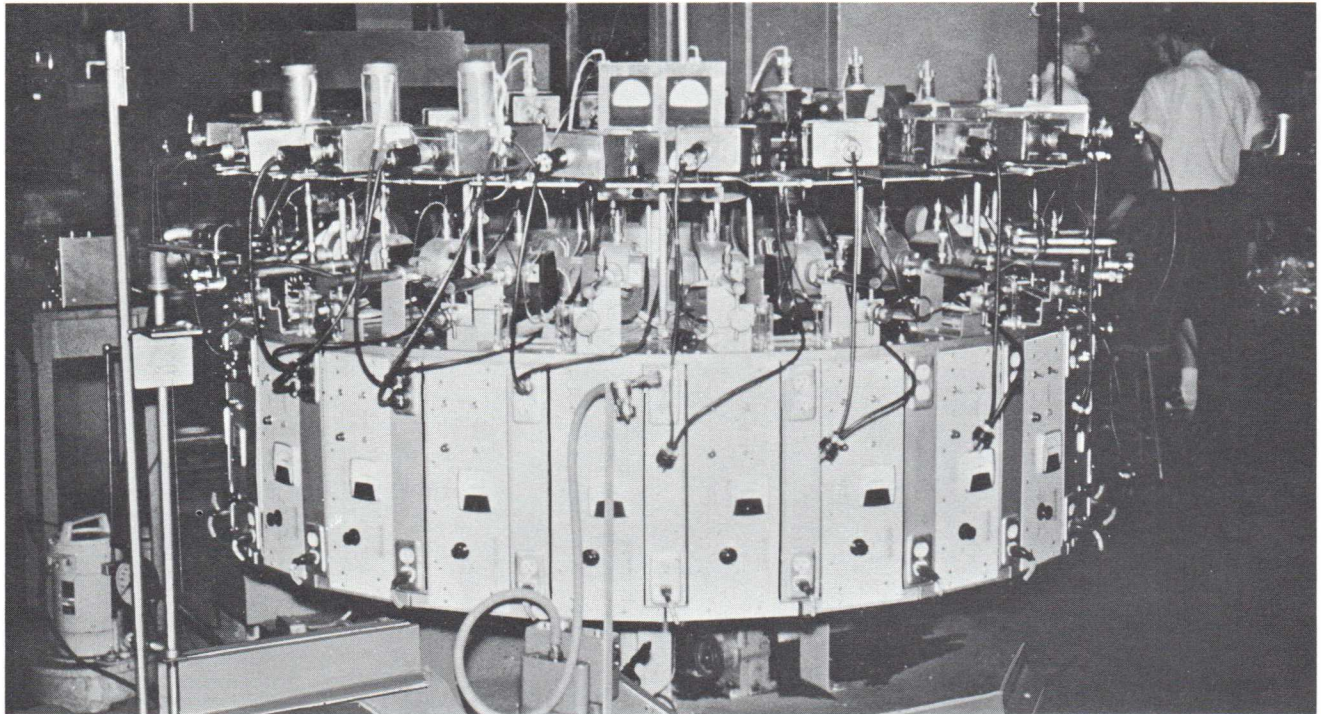

Magnetron exhaust machine insures high vacuum exhaust at high temperature bake out for long life tubes.



Hand assembly operation of magnetrons indicates the precise skill required for low volume, high precision products.

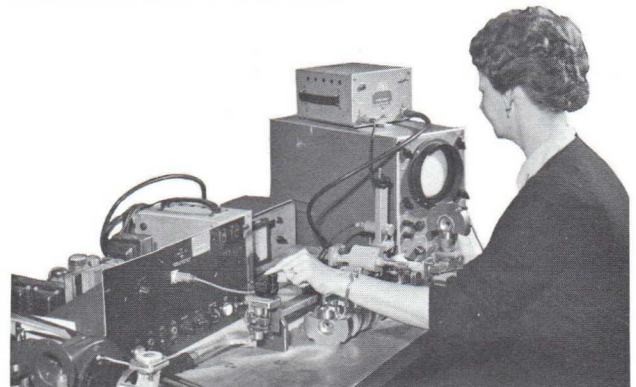

Klystron local oscillator is shown being used as signal source to test magnetron subassembly. Note fingertip tuning by exclusive Westinghouse adapter WL 22669 (see page 10 of this catalog).

systems. Whether it is a design engineer working on an improved cathode or a fast recovery gas for switch tubes or a factory girl skilled in assembling and testing component parts, these people are conscious that their microwave tube work is vital.

At the Westinghouse electronic tube division the quality control organization is established to meet Department of Defense MIL-Q-9858 and similar customer quality control procedure requirements. And local source inspection certifies to the meeting of specific contract requirements. Department of Defense clearance has been obtained to safeguard both products and production facilities. Verification of certificate DO 562 can be obtained from the U.S.A.F., Eastern Contract Management Region, Olmsted Air Force Base, Middletown, Pa.

For those microwave tubes requiring environmental testing, the Westinghouse tube division is well equipped for performing in plant tests for . . .

- | | |
|----------------------|-------------------|
| Temperature | Vibration |
| Temperature-shock | Mechanical shocks |
| Temperature-altitude | Humidity |
| Altitude | Salt Spray |
| Flammability | Immersion |

described in these specifications . . .

- | | |
|--------------|----------------------------|
| MIL-E-ID | MIL-E-4970A |
| MIL-STD-167 | MIL-E-5272C |
| MIL-STD-202A | MIL-E-5400C & MIL-T-5422E |
| MIL-STD-446 | MIL-E-16400C & MIL-T-17113 |
| MIL-STD-810 | |

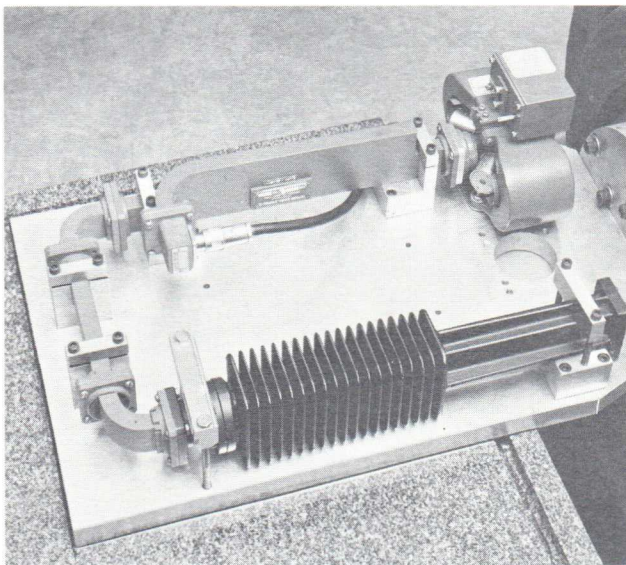

Special vibration test for operating magnetron.

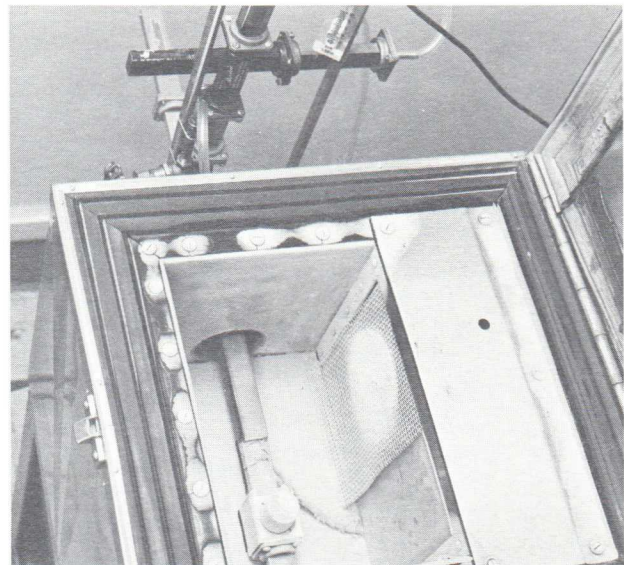

Cold chamber test of an operating microwave cavity. Temperature is at -54°C .

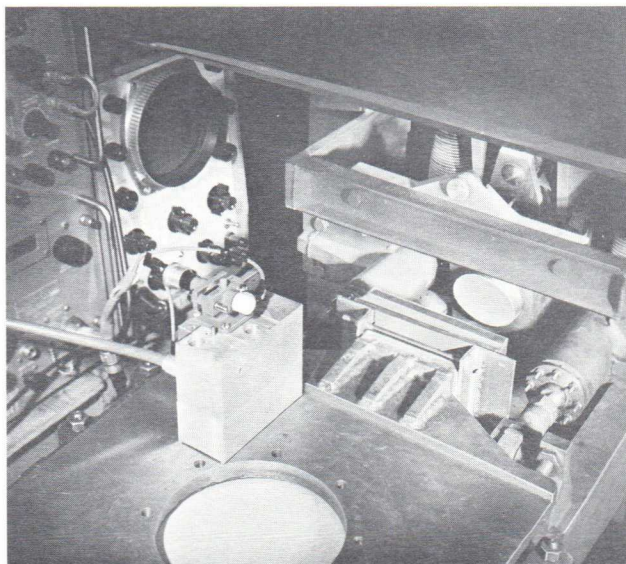

Shock test of an operating klystron. Note hammer head poised to strike the table.

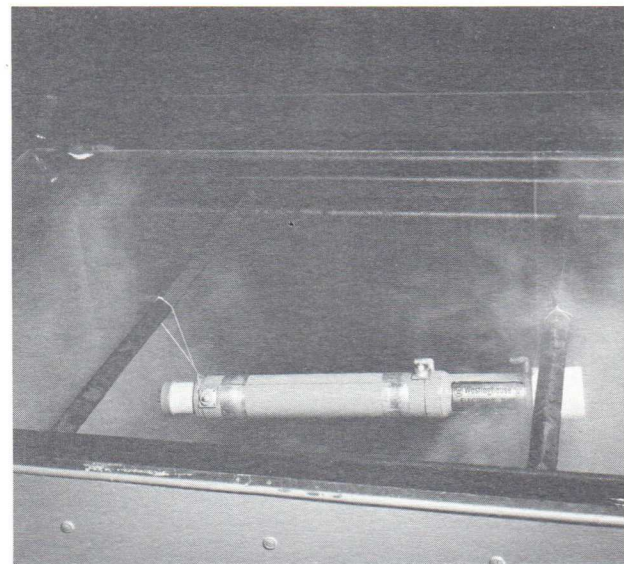

Special salt spray test chamber where a traveling wave tube is being punished.



ELECTRONIC COMPONENT SALES OFFICES

WEST COAST

Arcadia, Cal.	129 So. First Avenue	HI 6-4411
Compton, Cal.	18020 So. Santa Fe Avenue	NE 8-7781
Los Angeles, Cal.	600 St. Paul Avenue	HU 2-9660
Phoenix, Arizona	1102 N. 21st Avenue, Box 6144	254-5231
Portland, Oregon	1414 N.E. Grand Avenue, Box 7965	AT 8-6311
Salt Lake City, Utah	1680 So. Redwood Road	EL 5-3413
San Diego, Cal.	1365 Sixth Avenue	BE 4-4651
San Francisco, Cal.	410 Bush Street	EX 2-5353
Seattle, Washington	3451 E. Marginal Way, South	MA 2-0808
Sunnyvale, Cal.	Bldg. 73, Hendy Avenue	739-8507
Van Nuys, Cal.	15217 Burbank Blvd.	ST 2-9823

MIDWEST

Chicago, Ill.	Merchandise Mart Plaza, Box 3426	WH 4-3860
Dallas, Texas	1232 Fidelity Union Life Bldg., 1511 Bryan Street	RI 8-0711
Denver, Colo.	55 West Fifth Avenue	KE 4-8121
Detroit, Mich.	5757 Trumbull Avenue	TR 2-7010
Houston, Texas	507 Dallas Avenue	224-7791
Indianapolis, Ind.	1560 Stadium Drive	ME 2-3301
Kansas City, Mo.	Mulberry at 13th Street	HA 1-7122
Milwaukee, Wis.	538 N. Broadway	BR 6-1800
Minneapolis, Minn.	3501 S. Highway 100	WA 7-6551
New Orleans, La.	400 N. Carrollton Avenue, Box 19657	486-6141
Rockford, Ill.	2121 15th St.	398-3591
St. Louis, Mo.	411 N. 7th St.	GA 1-6911
Tulsa, Oklahoma	703 Enterprise Bldg.	DI 3-3191

EAST

Atlanta, Ga.	1299 Northside Dr., N. W., Box 4808	TR 4-1642
Baltimore, Md.	501 St. Paul Place	PL 2-0300
Bluefield, W. Va.	704 Bland St., Box 4295	325-7215
Boston, Mass.	10 High Street	LI 2-0600
Bridgeport, Conn.	540 Grant Street	ED 4-5161
Buffalo, N. Y.	Ellicott Square Building	TL 4-3966
Charlotte, N. C.	2001 W. Morehead St.	FR 7-3471
Cincinnati, Ohio	Gwynne Building	421-2250
Cleveland, Ohio	Illuminating Bldg., 55 Public Square	CH 1-7600
Columbus, Ohio	940 Williams Avenue	BR 9-7311
Dayton, Ohio	32 No. Main St.	BA 6-2511
Erie, Penn.	1007 Hess Ave., Box 2003	CL 2-4867
Hartford, Conn.	119 Ann Street	CH 6-5441
Huntsville, Ala.	220 Elec. Serv. Ctr., 112-118 Gallatin St.	JE 4-6447
Johnson City, N. Y.	4301 Old Vestal Rd., Box 148	RA 9-2258
Mineola, N. Y.	1501 Franklin Ave.	CH 8-9800
Newark, N. J.	1180 Raymond Blvd.	621-9000
New York, N. Y.	40 Wall St.	WH 3-4321
Olean, N. Y.	Exchange Natl. Bk. Bldg., 201 N. Union St.	372-0040
Orlando, Fla.	367 N. Orange Ave., Box 1826	241-6597
Philadelphia, Penn.	3001 Walnut St.	EV 2-1200
Pittsburgh, Penn.	306 Fourth Ave., Box 1017	EX 1-2800
Red Bank, N. J.	Hamilton Bldg., 43 W. Front St.	SH 7-5800
St. Petersburg, Fla.	Component Sales Corp., Box 9545	360-7460
Springfield, Mass.	160 Tapley St., Box 1611	RE 6-8373
Tampa, Fla.	4062 Henderson Blvd., Box 10597	253-0114
Washington, D.C.	1625 K St., N. W.	NA 8-8843
Winston-Salem, N. C.	Box 5463, Ardmore Station	724-5321

INTERNATIONAL SALES

Westinghouse Electric International S.A., 31 Rue de Rhone, Geneva, Switzerland
 Westinghouse Electric Co. S.A., P.O. Box 10004, San Juan, Puerto Rico
 Westinghouse Electric International Co., 200 Park Avenue, New York 17, New York

The information contained herein is supplied without assuming any responsibility for any infringement of patents or other rights of third parties which may result from its use. No license is granted by implication or otherwise under any patent or patent rights of Westinghouse Electric Corporation.

Westinghouse

ELECTRONIC TUBE DIVISION ELMIRA, NEW YORK