

Multiplier Phototube

10-Stage, Head-On Type Having S-11 Spectral Response

GENERAL

Spectral Response	S-11
Wavelength of Maximum Response	4400 \pm 500 Å
Cathode, Semitransparent	Cesium-Antimony with High-Conductivity Grating
Area including grating	1.8 in ² (11.6 cm ²)
Minimum diameter	1.5 in (3.8 cm)
Window	Corning ^a No.0080, or equivalent
Shape	Plano-Plano
Index of refraction at 4360 angstroms	1.523
Dynodes:	
Substrate	Copper-Beryllium
Secondary-Emitting Surface	Beryllium-Oxide
Structure	Circular-Cage, Electrostatic-Focus Type
Direct Interelectrode Capacitances (Approx.):	
Anode to dynode No.10	4.4 pF
Anode to all other electrodes	7.0 pF
Maximum Overall Length	5.81 in (14.8 cm)
Seated Length	4.88 \pm 0.19 in (12.4 \pm 0.48 cm)
Maximum Diameter	2.31 in (5.9 cm)
Bulb	T-16
Base	Medium-Shell Diheptal 14-Pin (JEDEC No.B14-38), Non-hygroscopic
Socket	Eby ^b No.9709-7, or equivalent
Magnetic Shield	Millen ^c Part No.80802B, or equivalent
Operating Position	Any
Weight (Approx.)	5.2 oz (174 g)

ABSOLUTE-MAXIMUM RATINGS

DC Supply Voltage:

Between anode and cathode	1500 max.	V
Between anode and dynode No.10	250 max.	V
Between consecutive dynodes	250 max.	V
Between dynode No.1 and cathode	400 max.	V



Between focusing electrode and cathode . . .	400 max. V
Average Anode Current ^e	2 max. mA
Average Cathode Current ^f	5 max. μ A
Ambient Temperature ^g	75 max. $^{\circ}$ C

CHARACTERISTICS RANGE VALUES

Under conditions with dc supply voltage (E) across a voltage divider providing 1/6 of E between cathode and dynode No.1; 1/12 of E for each succeeding dynode stage; and 1/12 of E between dynode No.10 and anode. Focusing-electrode voltage is adjusted to that value between 10 and 60 per cent of dynode No.1 potential (referred to cathode) which provides maximum anode current.

With E = 1250 volts (Except as noted)

	Min.	Typical	Max.	
Anode Sensitivity:				
Radiant ^h at 4400 angstroms	—	4.8×10^3	—	A/W
Luminous (2870 $^{\circ}$ K) ⁱ	2.5	6	75	A/lm
Cathode Sensitivity:				
Radiant ^k at 4400 angstroms	—	0.04	—	A/W
Luminous (2870 $^{\circ}$ K) ^m	3×10^{-5}	5×10^{-5}	—	A/lm
Current with blue light source (2870 $^{\circ}$ K + C.S. No.5-58) ⁿ	3×10^{-8}	5×10^{-8}	—	A
Quantum Efficiency at 4200 angstroms	—	11.5	—	%
Current Amplification	—	1.2×10^5	—	
Anode Dark Current ^p	—	4×10^{-9}	4.5×10^{-8}	A
Equivalent Anode Dark Current Input ^p	{ —	2×10^{-10} 2.5×10^{-13q}	2.25×10^{-9} 2.8×10^{-12q}	lm W
Equivalent Noise Input ^r	{ —	5.6×10^{-12} 7×10^{-15s}	1.9×10^{-11} 2.3×10^{-14s}	lm W

^a Made by Corning Glass Works, Corning, NY 14830.

- b** Made by Hugh H. Eby Company, 4701 Germantown Avenue, Philadelphia, PA 19144.
- c** Made by James Millen Manufacturing Company, 150 Exchange Street, Malden, MA 02148.
- e** Averaged over any interval of 30 seconds maximum.
- f** Above this value of average cathode current, serious loss in linearity between light input and anode current will be caused by the resistivity of the cathode.
- g** Tube operation at room temperature or below is recommended.
- h** This value is calculated from the typical anode luminous sensitivity rating using a conversion factor of 804 lumens per watt.
- i** Under the following conditions: The light source is a tungsten-filament lamp having a lime-glass envelope. It is operated at a color temperature of 2870° K and a light input of 10 microlumens is used.
- k** This value is calculated from the typical cathode luminous sensitivity rating using a conversion factor of 804 lumens per watt.
- m** Under the following conditions: The light source is a tungsten-filament lamp having a lime-glass envelope. It is operated at a color temperature of 2870° K. The value of light flux is 0.01 lumen and 200 volts are applied between cathode and all other electrodes connected as anode.
- n** Under the following conditions: Light incident on the cathode is transmitted through a blue filter (Corning C.S. No.5-58, polished to 1/2 stock thickness-Manufactured by the Corning Glass Works, Corning, NY 14830) from a tungsten-filament lamp operated at a color temperature of 2870° K. The value of light flux incident on the filter is 0.01 lumen and 200 volts are applied between cathode and all other electrodes connected as anode.
- p** At a tube temperature of 22° C. With supply voltage adjusted to give a luminous sensitivity of 20 amperes per lumen. Dark current caused by thermionic emission may be reduced by use of a refrigerant.
- q** At 4400 angstroms. These values are calculated from the EADCI values in lumens using a conversion factor of 804 lumens per watt.

Under the following conditions: Tube temperature 22°C , external shield connected to cathode, bandwidth 1 Hz, tungsten-light source at a color temperature of 2870°K interrupted at a low audio frequency to produce incident radiation pulses alternating between zero and the value stated. The "on" period of the pulse is equal to the "off" period.

At 4400 angstroms. These values are calculated from the ENI values in lumens using a conversion factor of 804 lumens per watt.

TYPICAL VOLTAGE-DIVIDER ARRANGEMENT

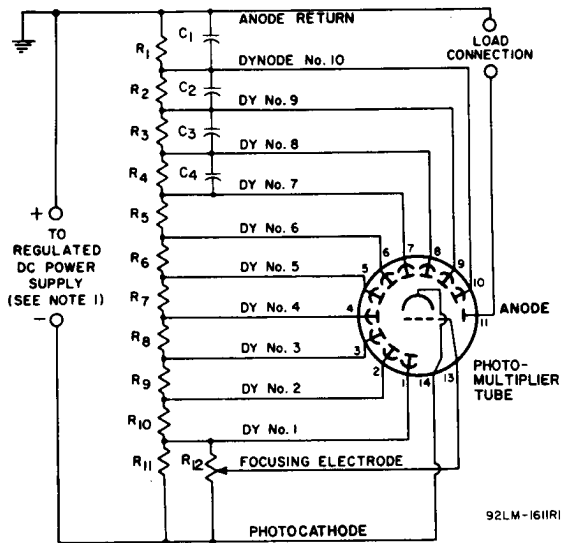

C_1 : $0.05\ \mu\text{F}$, 20%, 500 volts (dc working), ceramic disc

C_2 : $0.02\ \mu\text{F}$, 20%, 500 volts (dc working), ceramic disc

C_3 : $0.01\ \mu\text{F}$, 20%, 500 volts (dc working), ceramic disc

C_4 : $0.005\ \mu\text{F}$, 20%, 500 volts (dc working), ceramic disc

R_1 through R_{10} : 390,000 ohms, 5%, 1/2 watt

R_{11} : 910,000 ohms, 5%, 1/2 watt

R_{12} : 5 megohms, 20%, 1/2 watt, adjustable

Note 1: Adjustable between approximately 500 and 1500 volts dc.

Note 2: Component values are dependent upon nature of application and output signal desired.

DIMENSIONAL OUTLINE

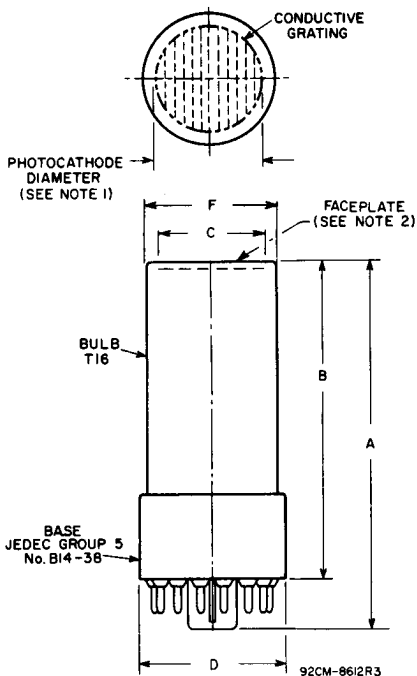

⊥ of bulb will not deviate more than 2° in any direction from the perpendicular erected at the center of bottom of the base.

Note 1: The grating consists of 12 equally spaced conductive strips having a maximum width of 0.02" (0.5 mm).

Note 2: Deviation from flatness will not exceed 0.010" from peak to valley.

OUTLINE DIMENSIONS

Dimensions	Inches	mm
A	5.81 max.	147.5 max.
B	4.88 ± .19	123.9 ± 4.8
C	1.5 min. dia.	38 min. dia.
D	2.31 max. dia.	58.6 max. dia.
F	2.00 ± .06 dia.	50.8 ± 1.5 dia.

TERMINAL DIAGRAM (Bottom View)

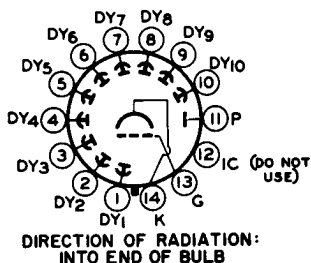

Pin 1: Dynode No.1

Pin 2: Dynode No.2

Pin 3: Dynode No.3

Pin 4: Dynode No.4

Pin 5: Dynode No.5

Pin 6: Dynode No.6

Pin 7: Dynode No.7

Pin 8: Dynode No.8

Pin 9: Dynode No.9

Pin 10: Dynode No.10

Pin 11: Anode

Pin 12: Internal connection-
Do not use

Pin 13: Focusing Electrode

Pin 14: Photocathode

Typical Spectral Response Characteristics

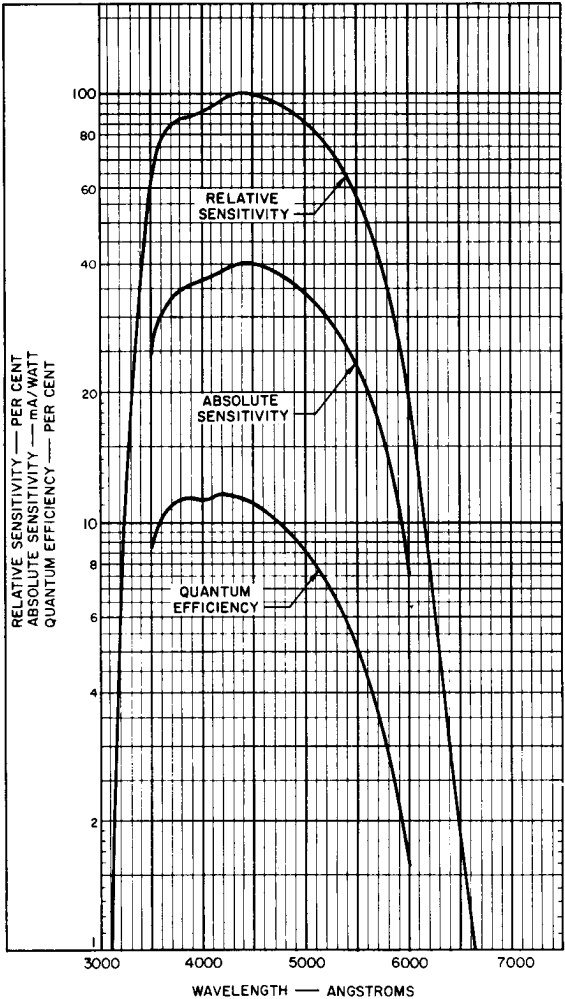

92LM-2843

Typical EADCI and Anode Dark Current Characteristics

LUMINOUS SENSITIVITY IS VARIED BY ADJUSTING THE SUPPLY VOLTAGE (E) ACROSS A VOLTAGE DIVIDER PROVIDING 1/6 OF E BETWEEN CATHODE AND DYNODE No. 1; 1/2 OF E FOR EACH SUCCEEDING DYNODE STAGE; AND 1/2 OF E BETWEEN DYNODE No. 10 AND ANODE.

FOCUSING ELECTRODE VOLTAGE IS ADJUSTED TO THAT VALUE BETWEEN 10 AND 60 PER CENT OF DYNODE No. 1 POTENTIAL (REFERRED TO CATHODE) WHICH PROVIDES MAXIMUM ANODE CURRENT.

LIGHT SOURCE IS A TUNGSTEN - FILAMENT LAMP OPERATED AT A COLOR TEMPERATURE OF 2870°K.

TUBE TEMPERATURE = 22°C

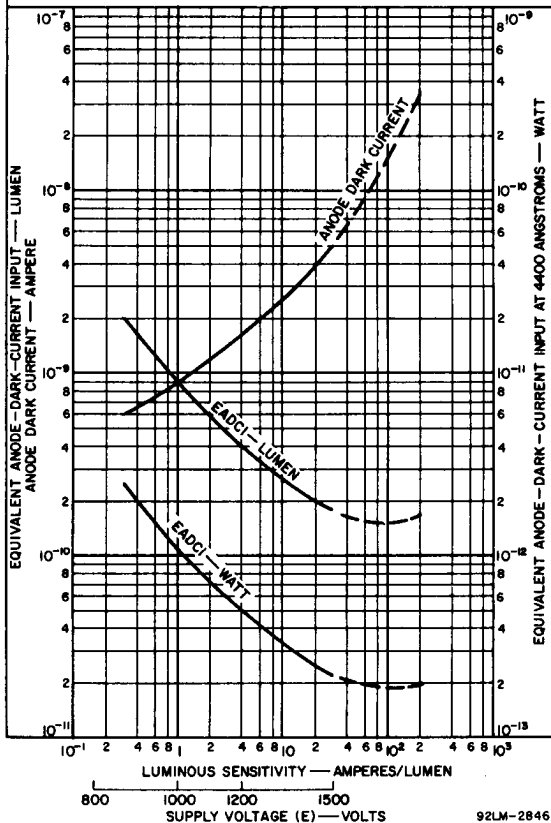

92LM-2846

Typical Anode Characteristics

DYNODE-NO. 1-TO-CATHODE VOLTS=200
 EACH SUCCEEDING-DYNODE-STAGE VOLTS=100
 FOCUSING ELECTRODE ADJUSTED TO PROVIDE
 MAXIMUM ANODE CURRENT.
 LIGHT SOURCE IS A TUNGSTEN-FILAMENT LAMP
 OPERATED AT COLOR TEMPERATURE OF 2870° K.

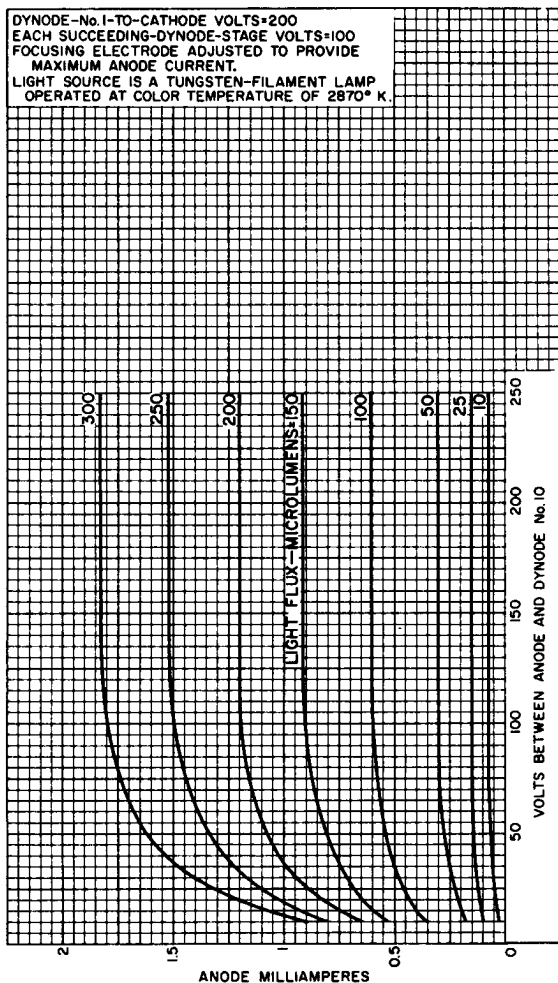

92CM-8641R2

Sensitivity and Current Amplification Characteristics

SUPPLY VOLTAGE (E) ACROSS VOLTAGE DIVIDER PROVIDING 1/6 OF E BETWEEN CATHODE AND DYNODE No.1; 1/12 OF E FOR EACH SUCCEEDING DYNODE STAGE; AND 1/12 OF E BETWEEN DYNODE No.10 AND ANODE. FOCUSING-ELECTRODE VOLTAGE ADJUSTED TO GIVE MAXIMUM ANODE CURRENT.

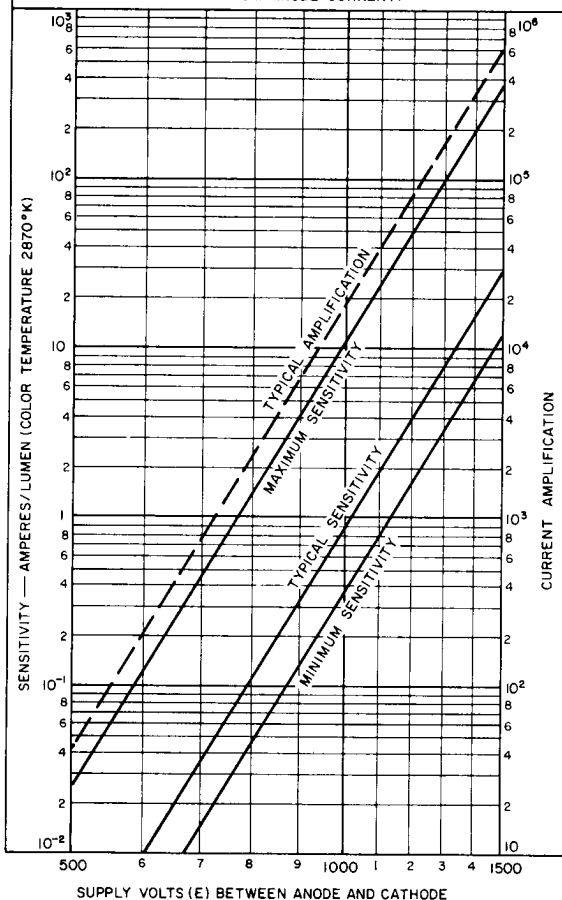

92LM-2848

Spectral Energy Distribution of 2870° K Light Source After Passing Through Indicated Filter

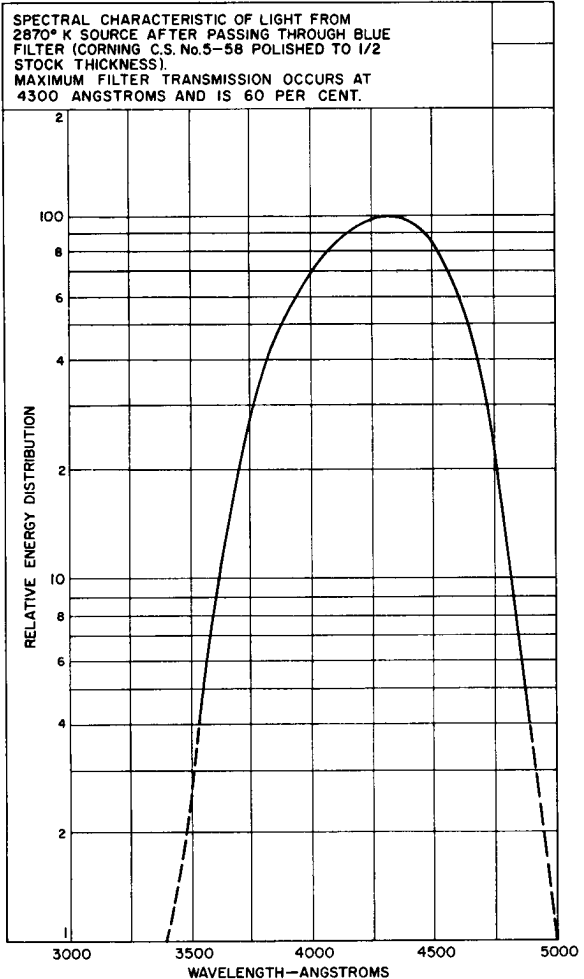

92CM-11081R1

Typical Effect of Magnetic Field on Anode Current

MAGNETIC FIELD IS PARALLEL TO DYNODE - CAGE AXIS.
POSITIVE VALUES ARE FOR LINES OF FORCE FROM LEFT
TO RIGHT WITH BASE DOWN AND BASE KEY TOWARD
OBSERVER.

DYNODE - No.1 - TO - CATHODE VOLTS = 150
EACH - SUCCEEDING - STAGE VOLTS = 100
FOCUSING - ELECTRODE VOLTAGE ADJUSTED TO GIVE
MAXIMUM ANODE CURRENT.

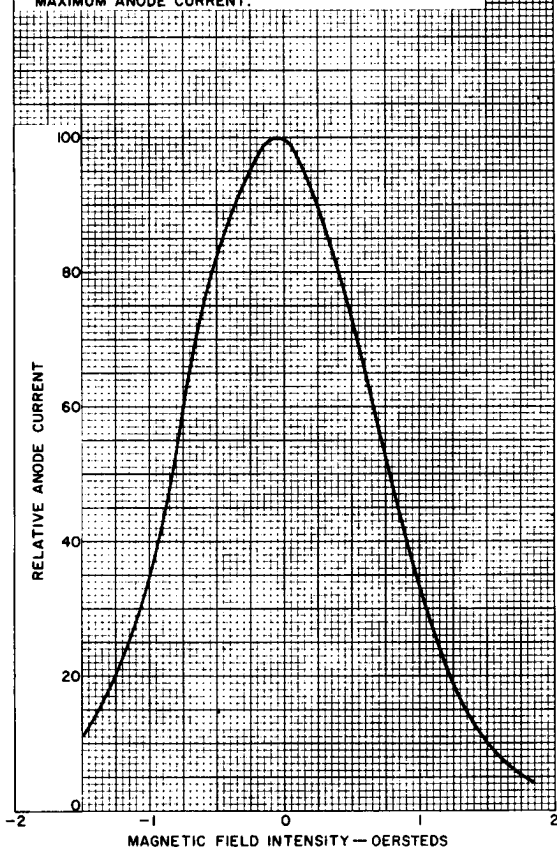

92CM-8136R3