

# EITEL-McCULLOUGH, INC.

SAN BRUNO, CALIFORNIA

# 1000T

HIGH-MU TRIODE

MODULATOR

OSCILLATOR

AMPLIFIER

## GENERAL CHARACTERISTICS

### ELECTRICAL

Filament: Thoriated tungsten	
Voltage - - - - -	7.5 volts
Current - - - - -	17.0 amperes
Amplification Factor (Average) - - - - -	35
Direct Interelectrode Capacitances (Average)	
Grid-Plate - - - - -	5.1 $\mu\mu\text{f}$
Grid-Filament - - - - -	9.3 $\mu\mu\text{f}$
Plate-Filament - - - - -	0.5 $\mu\mu\text{f}$
Transconductance ( $I_b=750 \text{ ma.}, E_b=6000, e_c=-62$ )	9050 $\mu\text{mhos}$
Frequency for Maximum Ratings - - - - -	50 mc

### MECHANICAL

Base - - - - -	4-pin with tubing for forced air No. 5004B
Basing - - - - -	RMA type 4AQ
Maximum Overall Dimensions:	
Length - - - - -	12.625 inches
Diameter - - - - -	5.125 inches
Net weight - - - - -	1.25 pounds
Shipping weight (Average) - - - - -	6.25 pounds

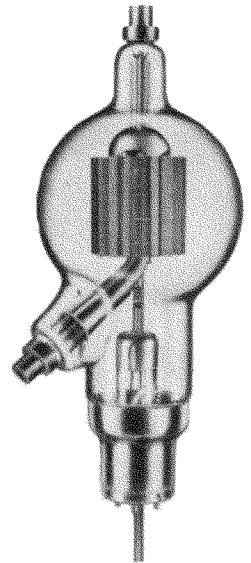

## AUDIO FREQUENCY POWER AMPLIFIER AND MODULATOR

### Class B

	TYPICAL OPERATION—2 TUBES			MAX. RATING	
	4000	5000	6000		
D-C Plate Voltage - - - - -	4000	5000	6000	7500	volts
Max.-Signal D-C Plate Current, per tube* - - -	•	•	•	750	ma.
Plate Dissipation, per tube* - - - - -	•	•	•	1000	watts
D-C Grid Voltage (approx.) - - - - -	-70	-105	-135		volts
Peak A-F Grid Input Voltage - - - - -	490	530	600		volts
Zero-Signal D-C Plate Current - - - - -	.300	.240	.200		amps.
Max.-Signal D-C Plate Current - - - - -	1.25	1.14	1.11		amps.
Max.-Signal Driving Power (approx.) - - - - -	28	31	35		watts
Effective Load, Plate-to-Plate - - - - -	6350	9250	12200		ohms
Max.-Signal Plate Power Output - - - - -	3000	3700	4600		watts

\*Averaged over any sinusoidal audio frequency cycle.

## RADIO FREQUENCY POWER AMPLIFIER AND OSCILLATOR

### Class-C \*Telegraphy

(Key down conditions without modulation)

	TYPICAL OPERATION—1 TUBE				MAX. RATING	
	3000	4000	5000	6000		
D-C Plate Voltage - - - - -	3000	4000	5000	6000	7500	volts
D-C Plate Current - - - - -	750	713	667	667	750	ma.
D-C Grid Current - - - - -	90	100	87	110	125	ma.
D-C Grid Voltage - - - - -	-150	-150	-225	-350		volts
Plate Power Output - - - - -	1350	1850	2333	3000		watts
Plate Input - - - - -	2250	2850	3333	4000		watts
Plate Dissipation - - - - -	900	1000	1000	1000	1000	watts
Peak R. F. Grid Input Voltage, (approx.) - - -	350	365	420	610		volts
Driving Power, (approx.) - - - - -	30	33	33	60		watts

\*The above figures show actual measured tube performance, and do not allow for variations in circuit losses.

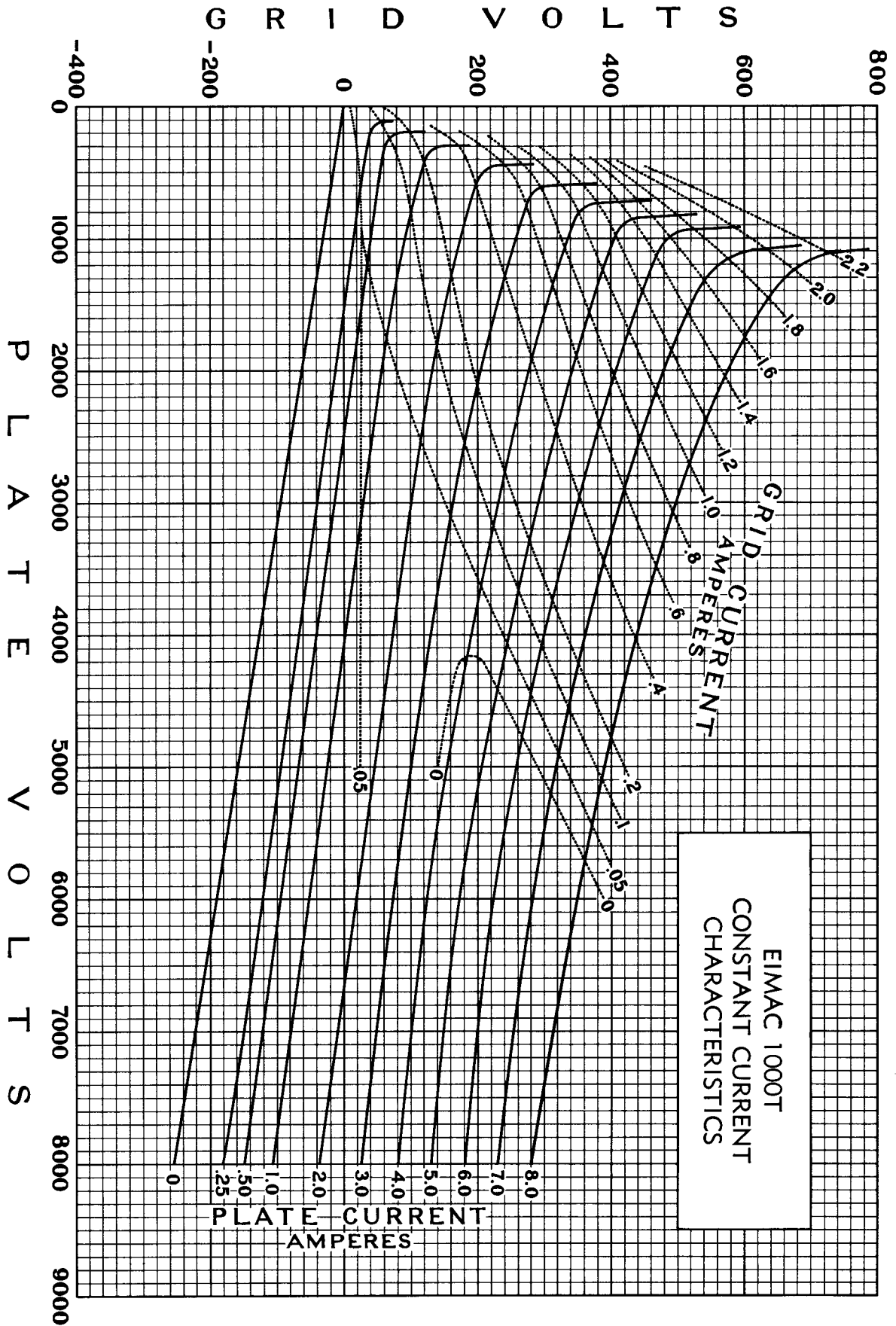

# DRIVING POWER vs. POWER OUTPUT

The three charts on this page show the relationship of plate efficiency, power output and grid driving power at plate voltages of 4000, 5000 and 6000 volts. These charts show combined grid and bias losses only. The driving power and power output figures do not include circuit losses. The plate dissipation in watts is indicated by  $P_p$ . Points A, B, and C are identical to the typical Class C operating conditions shown on the first page under 4000, 5000, and 6000 volts respectively.

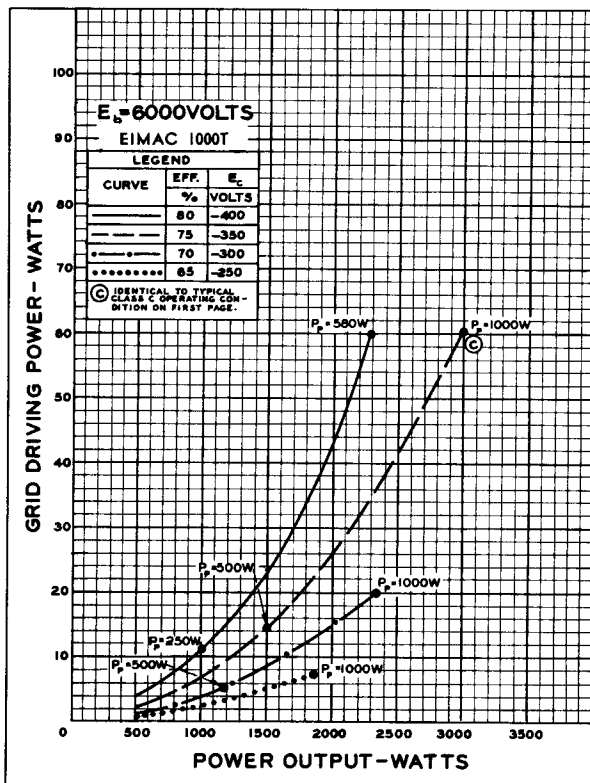
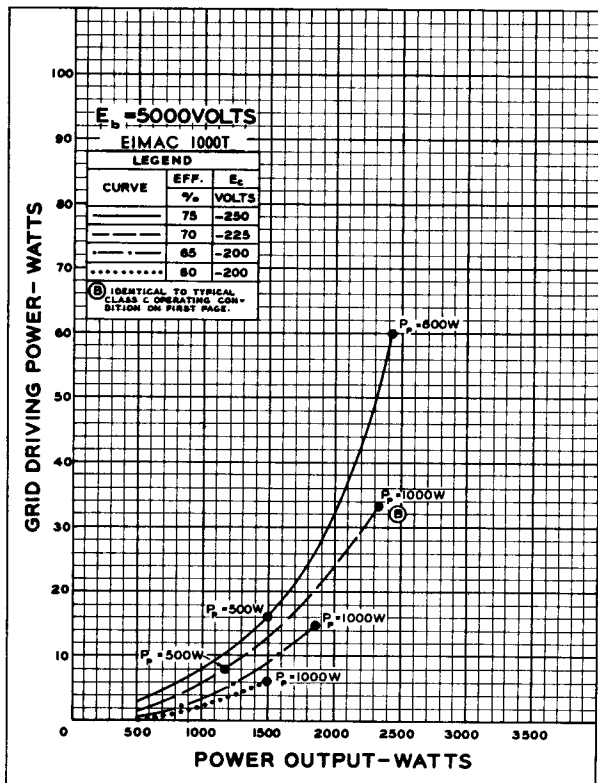
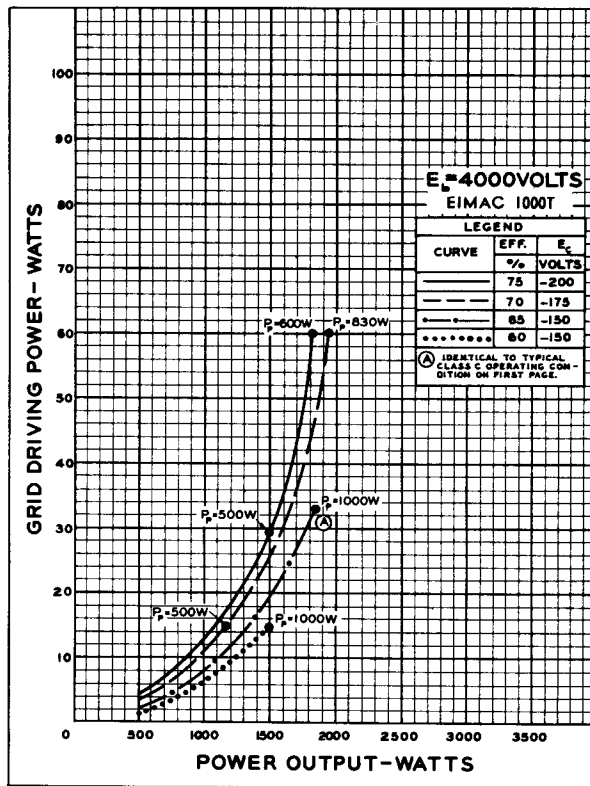

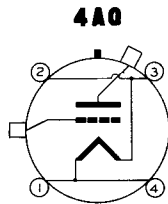
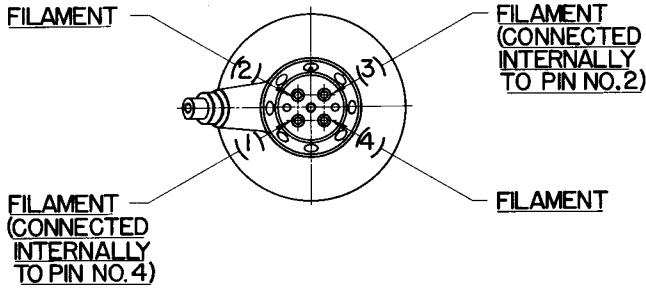
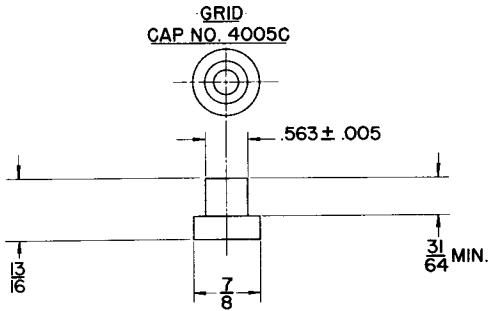
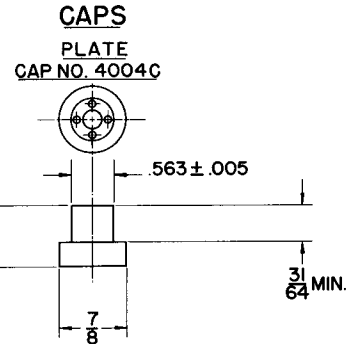
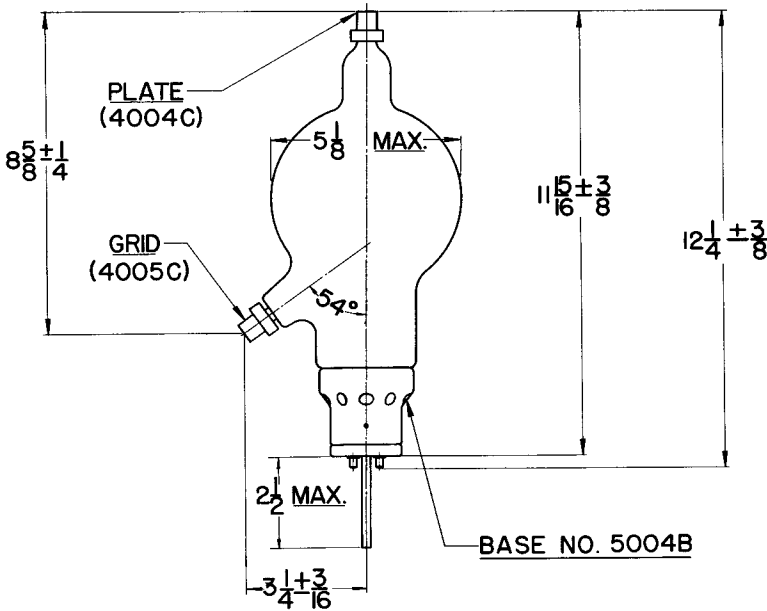

**BASE NO. 5004B**

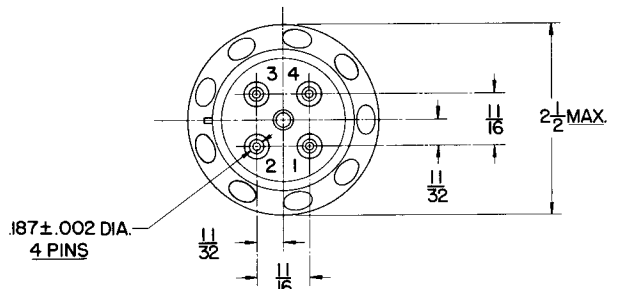
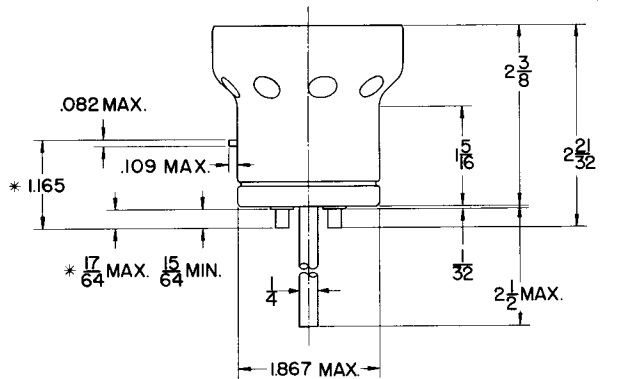

\* ON FINISHED TUBE ADD .060 FOR SOLDER

Forced air cooling on the seals of the Eimac 1000T, 1500T, and 2000T is recommended when tubes are operated under maximum conditions. We suggest the Roots Connersville blower unit No. 22. This blower when driven by a 1/4 H. P. motor at 1160 r.p.m. will deliver 13 cubic feet of air per minute at 1 pound pressure.

Each tube seal requires approximately 2 cubic feet per minute, therefore, one of these No. 22 blowers should handle any two of the above tubes.

We would suggest the outlet manifold, which is 1 inch in diameter, be kept to the shortest possible length—under 8 feet. It is also suggested 3/8 inch O.D. copper tubing be used from the outlet manifold to feed air to the various seals. It will be necessary to use an insulating type of tubing to actually connect to the tubes themselves. This tubing should have an I.D. of 5/16 inch.

Roots Connersville's plant is in Connersville, Indiana, with offices in most of the large cities.

Bulbs must be cooled with air equivalent to that supplied by standard 8" electric fan 12" from bulb.