



7913

METAL-CERAMIC TRIODE

DESCRIPTION AND RATING

The 7913 is a high-mu triode of ceramic-and-metal planar construction primarily intended for use as an oscillator or radio-frequency power amplifier.

GENERAL

ELECTRICAL	MECHANICAL
Cathode - Coated Unipotential	Operating Position - Any
Heater Characteristics and Ratings	See Outline Drawing on page 3 for dimensions and electrical connections.
Heater Voltage, AC or DC* 6.3±0.3 Volts	
Heater Current‡ 0.4 Amperes	
Direct Interelectrode Capacitances§	
Grid to Plate: (g to p) 2.4 pf	
Input: g to (h + k) 6.0 pf	
Output: p to (h + k) 0.03 pf	
Heater to Cathode: (h to k) 2.4 pf	

MAXIMUM RATINGS

ABSOLUTE-MAXIMUM VALUES

Plate Voltage	330	Volts
Plate Dissipation	5.5	Watts
DC Grid Current	10	Milliamperes
DC Cathode Current	30	Milliamperes
Peak Cathode Current	120	Milliamperes
Heater-Cathode Voltage		
Heater Positive with Respect to Cathode	50	Volts
Heater Negative with Respect to Cathode	50	Volts
Grid-Circuit Resistance		
With Fixed Bias	0.025	Megohms
With Cathode Bias	0.1	Megohms
Envelope Temperature at Hottest Point.	250	C

Absolute-Maximum ratings are limiting values of operating and environmental conditions applicable to any electron tube of a specified type as defined by its published data and should not be exceeded under the worst probable conditions.

The tube manufacturer chooses these values to provide acceptable serviceability of the tube, making no allowance for equipment variations, environmental variations, and the effects of changes in operating conditions due to variations in the characteristics of the tube under consideration and of

all other electron devices in the equipment.

The equipment manufacturer should design so that initially and throughout life no absolute-maximum value for the intended service is exceeded with any tube under the worst probable operating conditions with respect to supply-voltage variation, equipment component variation, equipment control adjustment, load variation, signal variation, environmental conditions, and variations in the characteristics of the tube under consideration and of all other electron devices in the equipment.

The tubes and arrangements disclosed herein may be covered by patents of General Electric Company or others. Neither the disclosure of any information herein nor the sale of tubes by General Electric Company conveys any license under patent claims covering combinations of tubes with other devices or elements. In the absence of an

express written agreement to the contrary, General Electric Company assumes no liability for patent infringement arising out of any use of the tubes with other devices or elements by any purchaser of tubes or others.

CHARACTERISTICS AND TYPICAL OPERATION

AVERAGE CHARACTERISTICS

Plate Voltage 200	Volts
Cathode-Bias Resistor 47	Ohms
Amplification Factor 100	
Plate Resistance, approximate	2500	Ohms
Transconductance	40000	Micromhos
Plate Current 25	Milliamperes
Grid Voltage, approximate		
I _b = 100 Microamperes	-4.5	Volts

UHF OSCILLATOR SERVICE

Frequency 400	Megacycles
Plate Voltage 300	Volts
Grid Resistor	1500	Ohms
Plate Current 25	Milliamperes
Grid Current, approximate 5	Milliamperes
Power Output, approximate 4	Watts

NOTES

- * The equipment designer should design the equipment so that heater voltage is centered at the specified bogey value, with heater supply variations restricted to maintain heater voltage within the specified tolerance.
- ‡ Heater current of a bogey tube at E_f = 6.3 volts.
- § Without external shield.

PHYSICAL DIMENSIONS

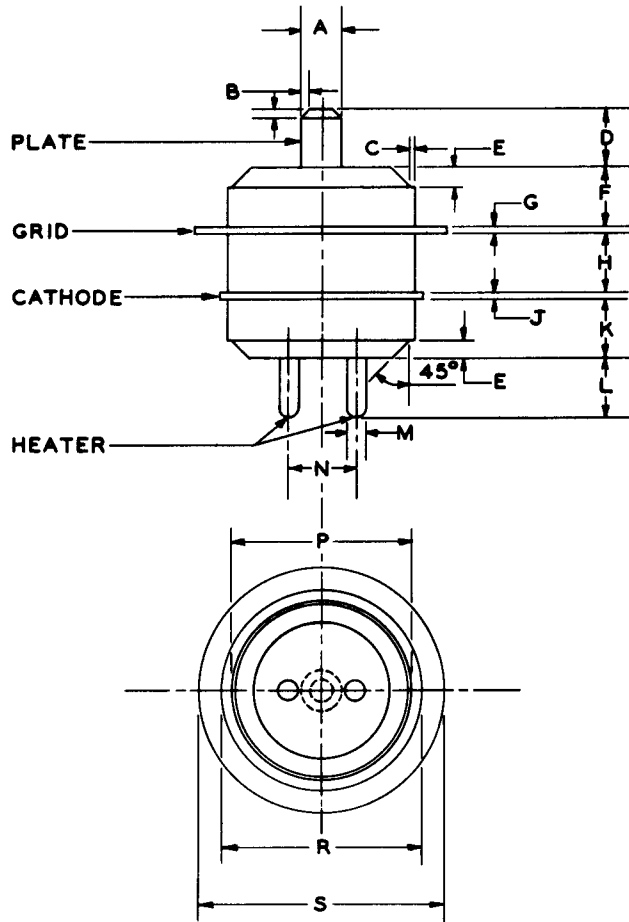

ALIGNMENT GAUGE

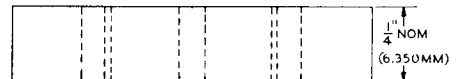
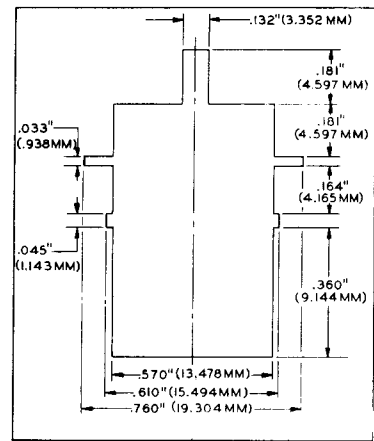

Note: Tolerances are ± 0.001 inches or ± 0.025 millimeters, unless otherwise indicated.

Ref.	INCHES			MILLIMETERS		
	Minimum	Nominal	Maximum	Minimum	Nominal	Maximum
A	0.122		0.128	3.099		3.251
B		0.030			0.76	
C		0.005			0.13	
D	0.170		0.180	4.32		4.57
E	0.040		0.060	1.02		1.52
F	0.165		0.175	4.19		4.45
G	0.025		0.031	0.635		0.787
H	0.167		0.177	4.24		4.50
J	0.025		0.031	0.635		0.787
K	0.170		0.180	4.32		4.57
L	0.170		0.180	4.32		4.57
M	0.047		0.053	1.194		1.346
N	0.185		0.215	4.70		5.46
P	0.535		0.565	13.59		14.35
R	0.598		0.608	15.19		15.44
S	0.748		0.758	19.00		19.25

Note: The millimeter dimensions are derived from the original inch dimensions.

AVERAGE PLATE CHARACTERISTICS

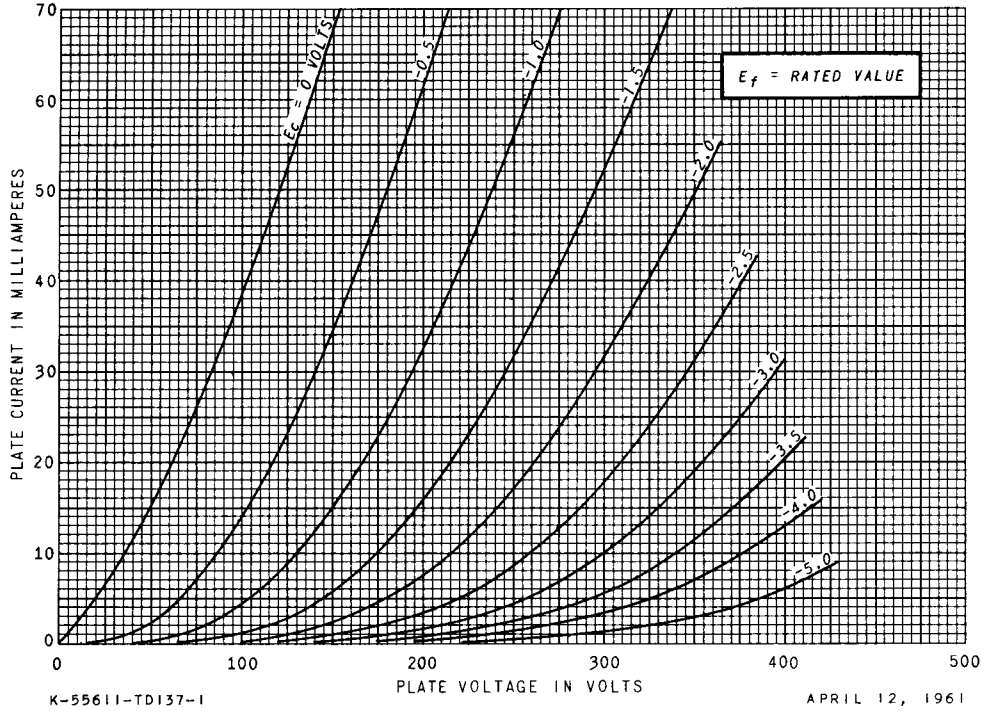

AVERAGE TRANSFER CHARACTERISTICS

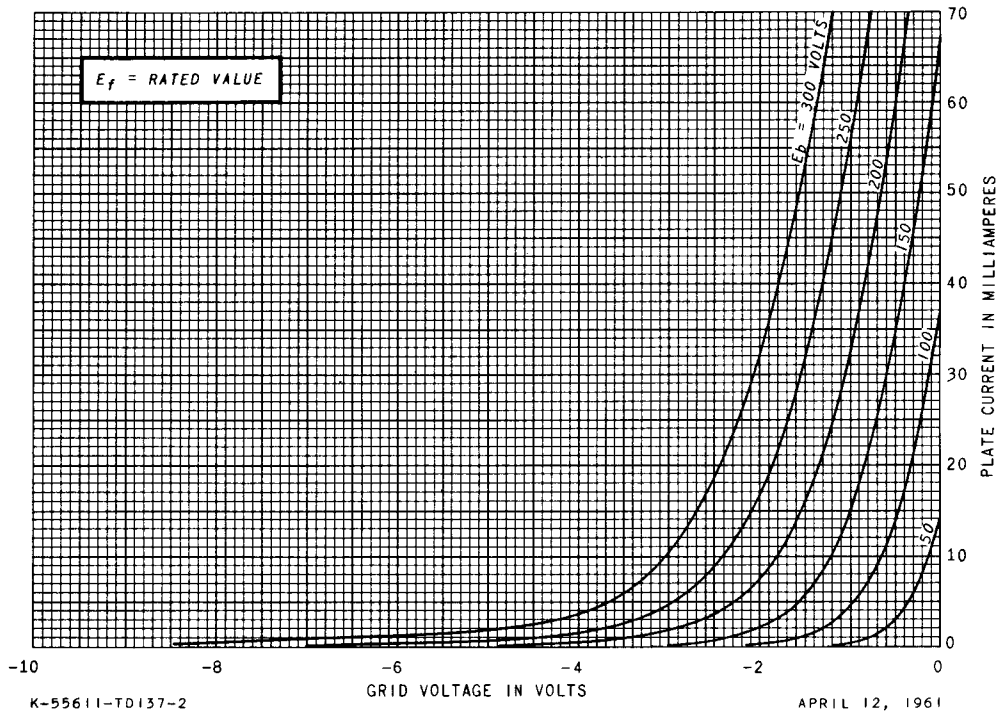

AVERAGE CHARACTERISTICS

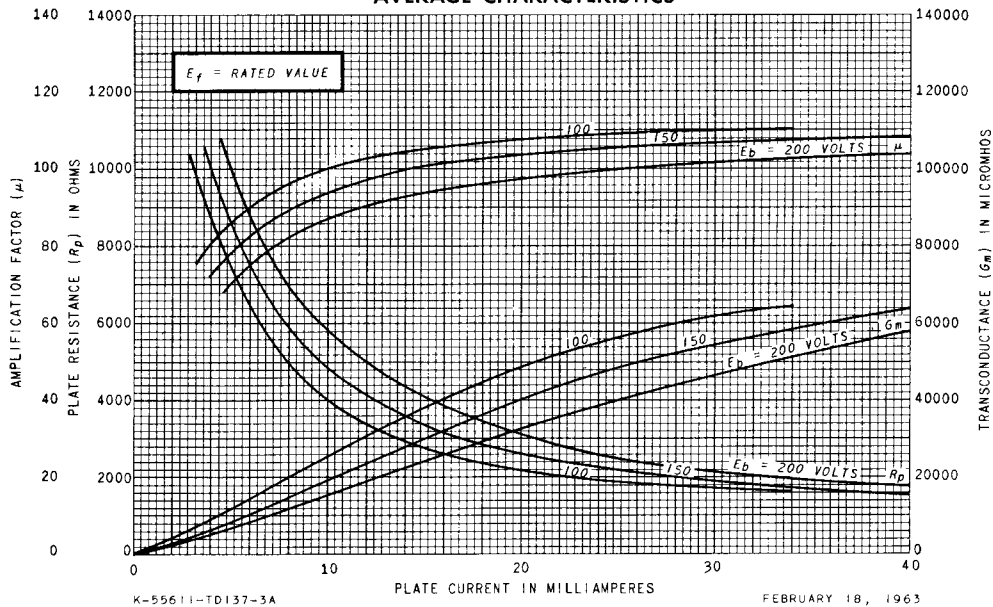

AVERAGE PLATE CHARACTERISTICS

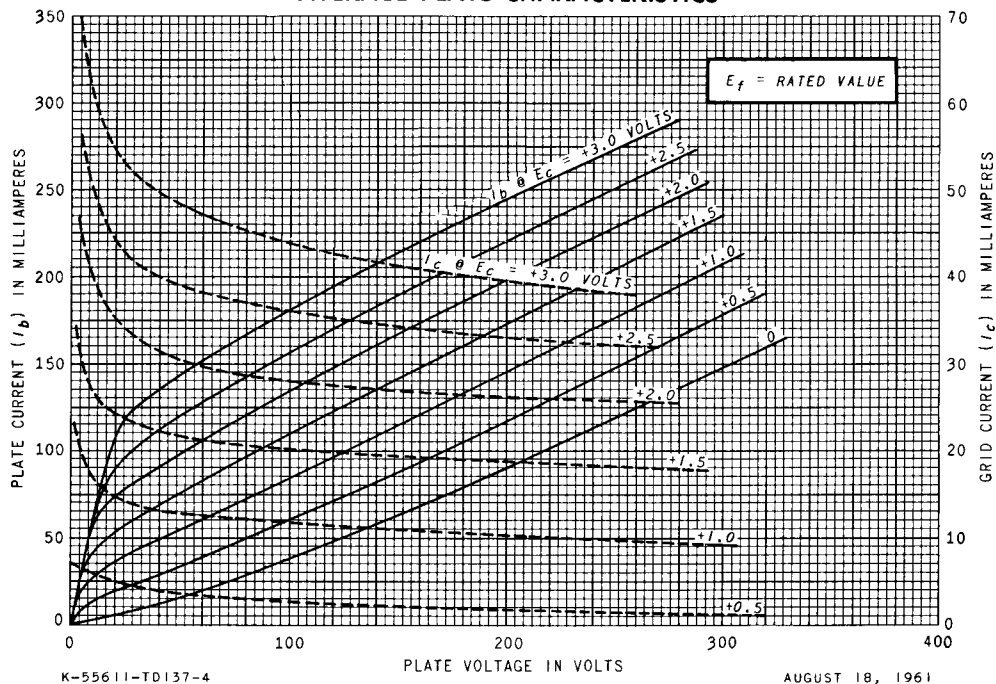

AVERAGE CONSTANT-CURRENT CHARACTERISTICS

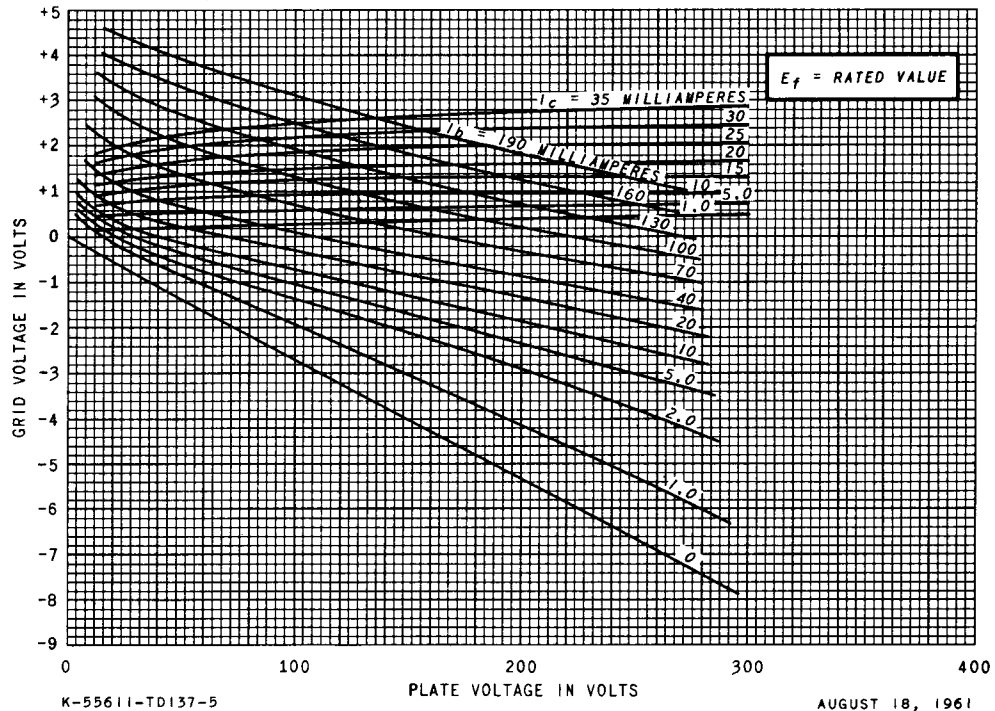

TUBE DEPARTMENT
GENERAL  **ELECTRIC**
Owensboro, Kentucky